

Cross-Platform Development in C

Mastering

NAPPGUI



Francisco García Collado



Cross-Platform C language development
How to create high-performance applications for Windows, macOS, and Linux
systems.

Version 1.4.3.5452 ¹

© 2015-2024 Francisco García Collado²
frang@nappgui.com
www.nappgui.com

20 September 2024

¹This book has been edited in \LaTeX generated automatically by **ndoc**.

²All rights reserved. This book is provided for personal use only. Unauthorized use, reproduction and/or distribution strictly prohibited.

Contents

1	Users guide	3
1	Quick start	5
1.1	Quick start	5
1.2	Quick start in Windows	5
1.3	Quick start on macOS	7
1.4	Quick start on Linux	8
1.5	MIT License	10
1.6	Previous knowledge	10
1.7	And now what?	11
2	Welcome to NAppGUI	13
2.1	Welcome to NAppGUI	13
2.2	Original APIs	15
2.3	C-based	16
2.4	No visual editors	16
2.5	Dependencies	18
2.6	Low and high level	21
3	Hello World!	23
3.1	Hello World!	23
3.2	The complete program	24
3.3	The skeleton	26
3.4	The constructor	27
3.5	The main panel	28
3.6	The destructor	28
3.7	Launch the window	28
3.8	Layout format	29
3.9	Exiting the program	29
3.10	Button Events	30
4	Use of C	31
4.1	Use of C	31
4.2	Basic types	32
4.3	Structures and unions	34
4.4	Control	35

Contents

4.5	Functions	37
4.6	Scopes	38
4.7	Pointers	39
4.8	Preprocessor	40
4.9	Comments	41
4.10	Input/Output	42
4.11	Mathematical algorithms	43
5	Use of C++	45
5.1	Use of C++	45
5.2	Encapsulation	46
5.3	Class callbacks	46
5.4	Combine C and C++ modules	48
5.4.1	Using C from C++	48
5.4.2	Using C++ from C	48
5.5	new and delete overload	49
5.6	Hello C++ complete	50
5.7	Math templates	53
6	Error management	57
6.1	Error management	57
6.2	Exhaustive tests	57
6.3	Static analysis	58
6.3.1	Standards	58
6.3.2	Compiler warnings	60
6.4	Dynamic analysis	61
6.4.1	Disabling Asserts	63
6.4.2	Debugging the program	63
6.4.3	Error log	63
6.4.4	Memory auditor	64
7	Build NAppGUI	65
7.1	Build NAppGUI	65
7.2	Static linking	65
7.3	Dynamic linking	66
7.4	CMake Options	67
7.5	Build Options	68
7.6	Packaging and installation	69
8	Create new application	71
8.1	Create new application	71
8.2	Use of find_package()	71

8.3	NAppProject.cmake	73
8.4	Add files	75
8.5	Command line applications	76
8.6	Example projects	78
8.7	C/C++ standard	78
9	Create new library	81
9.1	Create new library	81
9.2	Static libraries	81
9.3	Dynamic libraries	85
9.3.1	Advantages of DLLs	86
9.3.2	Disadvantages of DLLs	87
9.3.3	Check links with DLLs	88
9.3.4	Loading DLLs at runtime	91
9.3.5	Location of DLLs	93
9.4	Symbols and visibility	95
9.4.1	Export in DLLs	96
9.4.2	Checking in DLLs	97
10	Resources	99
10.1	Resources	99
10.2	Types of resources	100
10.3	Create resources	101
10.4	Internationalization (i18n)	102
10.5	Runtime translation	104
10.6	Edit resources	106
10.7	Manual management	106
10.8	Resource processing	107
10.9	Resource distribution	107
10.10	nrc warnings	109
10.11	Application icon	110
11	Generators, compilers and IDEs	113
11.1	Generators, compilers and IDEs	114
11.2	Portability concept	114
11.3	CMake Generators	115
11.4	Visual Studio	116
11.4.1	Platform toolset	118
11.4.2	Visual C++ Redistributable	119
11.4.3	WindowsXP support	120
11.4.4	SSE support	120

Contents

11.5	MinGW	121
11.5.1	MinGW-GCC	121
11.5.2	MinGW-Clang	122
11.5.3	MSYS2	122
11.6	Xcode	123
11.6.1	Base SDK and Deployment Target	126
11.6.2	xcode-select	128
11.6.3	macOS ARM	128
11.6.4	macOS 32bits	130
11.7	macOS Make	131
11.8	Linux GCC	132
11.8.1	Multiple versions of GCC	136
11.8.2	Linux 32bits	137
11.8.3	Linux ARM	137
11.9	Linux Clang	137
11.10	Linux GTK	139
11.11	Ninja	140
11.12	Configurations	141
11.13	Eclipse CDT	143
11.14	Visual Studio Code	144
2	Introduction to the API	149
12	NAppGUI SDK	151
12.1	NAppGUI API	151
12.2	Online resources	153
12.3	A little history	153
13	Sewer library	155
13.1	Sewer	156
13.1.1	The C standard library	156
13.2	Asserts	159
13.3	Pointers	160
13.4	Unicode	161
13.4.1	UTF encodings	163
13.4.2	UTF-32	163
13.4.3	UTF-16	163
13.4.4	UTF-8	164
13.4.5	Using UTF-8	165
13.5	Maths	166
13.5.1	Random numbers	166

13.6	Standard functions	167
13.6.1	Date conversion	167
13.7	Standard I/O	168
13.8	Memory	169
13.8.1	Stack Segment	169
13.8.2	Heap Segment	170
14	Osbs library	173
14.1	Osbs	174
14.2	Processes	175
14.2.1	Launching processes	175
14.2.2	Multi-processing examples	176
14.3	Threads	178
14.3.1	Throwing threads	179
14.3.2	Shared variables	179
14.3.3	Multi-thread example	180
14.4	Mutual exclusion	183
14.4.1	Locks	183
14.5	Loading libraries	183
14.5.1	Library search paths	184
14.5.2	Search order in Windows	184
14.5.3	Search order on Linux/macOS	185
14.6	Files and directories	185
14.6.1	File System	185
14.6.2	Files and data streams	186
14.6.3	Filename and pathname	186
14.6.4	Home and AppData	187
14.7	Sockets	187
14.7.1	Client/Server example	188
14.8	Time	191
14.9	Log	192
15	Core library	193
15.1	Core	195
15.2	Heap - Memory manager	196
15.2.1	Multi-thread memory	197
15.2.2	How Heap Works	197
15.3	Buffers	200
15.4	Strings	200
15.5	Streams	201
15.5.1	Stream Types	201
15.5.2	File stream	202

Contents

15.5.3	Socket stream	202
15.5.4	Block stream	203
15.5.5	Memory stream	203
15.5.6	Standard stream	204
15.5.7	Null stream	204
15.5.8	Binary stream	205
15.5.9	Text stream	206
15.5.10	Tokens	207
15.5.11	Identifiers	208
15.5.12	Strings	209
15.5.13	Numbers	210
15.5.14	Symbols	210
15.5.15	Comments	211
15.5.16	Stream advantages	211
15.5.17	Unify serialization	211
15.5.18	More elegance	212
15.5.19	Higher productivity	213
15.5.20	Higher performance	213
15.5.21	Byte order	213
15.5.22	Stream state	214
15.6	Arrays	215
15.6.1	Registers or pointers	216
15.6.2	Type check	218
15.6.3	Constructors	219
15.6.4	Array loops	220
15.6.5	Copy objects	220
15.6.6	Serialization	221
15.6.7	Destructors	222
15.6.8	Sort and search	223
15.6.9	Arrays of basic types	225
15.7	Arrays (pointers)	225
15.8	Binary search trees	225
15.8.1	Iterators	227
15.8.2	Arrays vs Sets comparative	228
15.9	Binary search trees (pointers)	230
15.10	Regular expressions	230
15.10.1	Define patterns	230
15.10.2	Regular languages and automata	232
15.11	Data binding	233
15.11.1	Synchronization with graphical interfaces	234
15.11.2	Read and write JSON	235
15.11.3	Serialization with DBind	235

15.11.4	Default constructor	236
15.11.5	Numerical ranges	237
15.12	Events	237
15.13	Keyboard buffer	238
15.14	File operations	238
15.15	Resource packs	240
15.16	Dates	240
15.17	Clocks	241
16	Geom2D library	243
16.1	Geom2D	243
16.2	2D Vectors	245
16.2.1	CW and CCW angles	246
16.2.2	Vector projection	246
16.3	2D Size	248
16.4	2D Rectangles	248
16.5	2D Transformations	249
16.5.1	Elementary transformations	249
16.5.2	Composition of transformations	250
16.5.3	Decomposition and inverse	253
16.6	2D Segments	254
16.7	2D Circles	255
16.8	2D Boxes	255
16.9	2D Oriented Boxes	255
16.10	2D Triangles	257
16.11	2D Polygons	258
16.11.1	Polygon center	259
16.11.2	Polygon decomposition	260
16.12	2D Collisions	261
17	Draw2D library	263
17.1	Draw2D	264
17.2	2D Contexts	265
17.2.1	Reference systems	267
17.2.2	Cartesian systems	270
17.2.3	Antialiasing	271
17.2.4	Retina displays	272
17.3	Drawing primitives	273
17.3.1	Line drawing	273
17.3.2	Figures and borders	274
17.3.3	Gradients	275
17.3.4	Gradient transformation	277

Contents

17.3.5	Gradients in lines	278
17.3.6	Gradient Limits	279
17.3.7	Drawing text	279
17.3.8	Drawing images	282
17.3.9	Default parameters	283
17.4	Geom2D Entities Drawing	284
17.5	Colors	285
17.5.1	HSV space	286
17.6	Palettes	287
17.6.1	Predefined palette	288
17.7	Pixel Buffer	288
17.7.1	Pixel formats	289
17.7.2	Procedural images	290
17.7.3	Copy and conversion	291
17.8	Images	291
17.8.1	Load and view images	292
17.8.2	Generate images	293
17.8.3	Pixel access	293
17.8.4	Save images: Codecs	294
17.9	Fonts	296
17.9.1	Create fonts	296
17.9.2	System font	298
17.9.3	Monospace font	298
17.9.4	Font style	299
17.9.5	Size and metrics	300
17.9.6	Size in points	300
17.9.7	Bitmap and Outline fonts	301
17.9.8	Unicode and glyphs	302
18	Gui library	303
18.1	Gui	305
18.1.1	Declarative composition	306
18.1.2	Anatomy of a window.	307
18.1.3	GUI Events	308
18.2	GuiControl	311
18.3	Label	312
18.3.1	Multiline label	313
18.3.2	Label in forms	314
18.3.3	Dynamic labels	314
18.4	Button	316
18.4.1	RadioGroup	317
18.4.2	Button shortcuts	318

18.5	PopUp	319
18.6	Edit	319
18.6.1	Validate texts	319
18.6.2	Filter texts	320
18.6.3	Text selection	322
18.6.4	Clipboard operations	323
18.7	Combo	323
18.8	ListBox	324
18.9	UpDown	324
18.10	Slider	326
18.11	Progress	326
18.12	View	327
18.12.1	Draw in views	328
18.12.2	Scrolling views	328
18.12.3	Drawing overlays	330
18.12.4	Using the mouse	331
18.12.5	Using the keyboard	332
18.13	TextView	332
18.13.1	Character format	333
18.13.2	Paragraph format	334
18.13.3	Document format	335
18.13.4	Apply attributes	335
18.13.5	Text wrapping	335
18.14	WebView	335
18.14.1	WebView dependencies	336
18.14.2	WebView on Windows	337
18.14.3	WebView on macOS	337
18.14.4	WebView on Linux	337
18.14.5	Disable WebView	338
18.15	ImageView	338
18.16	TableView	339
18.16.1	Data connection	339
18.16.2	Data cache	342
18.16.3	Multiple selection	344
18.16.4	Table navigation	344
18.16.5	Configure columns	345
18.16.6	Notifications in tables	345
18.16.7	Table appearance	346
18.17	SplitView	347
18.17.1	Add controls	348
18.17.2	Split modes	349

Contents

18.18	Layout	350
18.18.1	Natural sizing	351
18.18.2	Margins and format	352
18.18.3	Alignment	353
18.18.4	Sub-layouts	354
18.18.5	Cell expansion	355
18.18.6	Dynamic interfaces	356
18.18.7	Replacing panels	357
18.18.8	Dynamic layouts	357
18.18.9	Tabstops	359
18.19	Cell	361
18.20	Panel	361
18.20.1	Multi-layout panel	362
18.20.2	Understanding panel sizing	363
18.21	Window	367
18.21.1	Window size	369
18.21.2	Closing the window	369
18.21.3	Modal windows	370
18.21.4	Overlay windows	372
18.21.5	Keyboard focus	373
18.21.6	Focus change	374
18.21.7	Focus protocol	374
18.21.8	Tablist without cycles	375
18.21.9	Default button	375
18.21.10	Keyboard shortcuts	375
18.22	GUI Data binding	377
18.22.1	Basic type binding	377
18.22.2	Limits and ranges	380
18.22.3	Nested structures	381
18.22.4	Notifications and calculated fields	385
18.23	Menu	387
18.24	MenuItem	389
18.25	Common dialogs	389
19	OSApp library	393
19.1	OSApp	393
19.2	main() and osmain()	393
19.3	Synchronous applications	397
19.4	Multi-threaded tasks	398
20	INet library	401
20.1	INet	401

20.2	HTTP	402
20.3	JSON	403
20.3.1	JSON parsing and conversion to data in C	405
20.3.2	Mapping between Json and C	408
20.3.3	Convert from C to JSON	409
20.4	URL	411
20.5	Base64	413
21	OGL3D library	415
21.1	OGL3D	415
21.2	3D Contexts	416
21.3	Drawing operation	417
21.4	GLEW	418
3	Sample Applications	421
22	Die	423
22.1	Die	423
22.2	Use of sublayouts	424
22.3	Use of Custom Views	426
22.4	Parametric drawing	427
22.5	Resizing	429
22.6	Use of resources	431
22.7	Die and Dice	432
22.8	The complete Die program	433
23	Bricks	439
23.1	Bricks	439
24	Fractals	447
24.1	Fractals	447
25	Bode	457
25.1	Bode	457
26	Products	465
26.1	Products	465
26.2	Specifications	467
26.3	Model-View-Controller	468
26.4	Model	468
26.4.1	JSON WebServices	469
26.4.2	Write/Read on disk	471

Contents

26.4.3	Add/Delete records	472
26.5	View	473
26.5.1	Multi-layout panel	474
26.5.2	Hide columns	475
26.5.3	Bar graphs	476
26.5.4	Translations	477
26.5.5	<i>Dark Mode</i> themes	478
26.6	Controller	479
26.6.1	Multi-threaded login	480
26.6.2	Synchronize Model and View	481
26.6.3	Change the image	483
26.6.4	Memory management	484
26.7	The complete program	485
27	Hello GUI!	525
27.1	Hello GUI!	526
27.2	Hello Label!	526
27.3	Hello Button!	530
27.4	Hello PopUp and Combo!	533
27.5	Hello Edit and UpDown!	535
27.6	Hello TextSel and Clipboard!	543
27.7	Hello TextEditor!	549
27.8	Hello ListBox!	556
27.9	Hello Slider and Progress!	559
27.10	Hello TextView!	560
27.11	Hello TableView!	563
27.12	Hello SplitView!	570
27.13	Hello Modal Window!	572
27.14	Hello Overlay Window!	577
27.15	Hello Gui Binding!	583
27.16	Hello Struct Binding!	587
27.17	Hello Sublayout!	595
27.18	Hello Subpanel!	598
27.19	Hello Multi-layout!	599
27.20	Hello Scroll-Panel!	602
27.21	Hello Dynamic Layout!	603
27.22	Hello IP-Input!	618
28	Hello Draw2d!	621
28.1	Hello Draw2d!	621
29	Hello WebView!	641

29.1	Hello WebView!	641
30	Hello 3D Graphics!	649
30.1	Hello 3D Graphics!	649
31	Hello 2D Collisions!	677
31.1	Hello 2D Collisions!	677
32	Drawing on an image	721
32.1	Drawing on an image	721
33	DrawBig	731
33.1	DrawBig	731
33.2	DrawBig layout	731
33.3	DrawBig expansion	734
33.4	Drawing view in DrawBig	735
33.5	DrawBig overlay	736
33.6	DrawBig multilayout	737
33.7	DrawBig animations	738
33.8	Layout coloring in DrawBig	739
33.9	DrawBig overlapping windows	740
33.10	DrawBig source code	741
34	Images from URLs	761
34.1	Images from URLs	761
35	Color table	769
35.1	Color table	769
36	Read/Write Json	775
36.1	Read/Write Json	775
37	Alternative to STL	783
37.1	Alternative to STL	783
4	Library reference	791
38	Sewer library	793
38.1	Types and Constants	793
38.2	Functions	798
39	Osbs library	853
39.1	Types and Constants	853

39.2	Functions	858
40	Core library	889
40.1	Types and Constants	889
40.2	Functions	900
41	Geom2D library	1041
41.1	Types and Constants	1041
41.2	Functions	1047
42	Draw2D library	1113
42.1	Types and Constants	1113
42.2	Functions	1118
43	Gui library	1173
43.1	Types and Constants	1173
43.2	Functions	1189
44	OSApp library	1325
44.1	Functions	1325
45	INet library	1331
45.1	Types and Constants	1331
45.2	Functions	1332
46	OGL3D library	1345
46.1	Types and Constants	1345
46.2	Functions	1347

Part 1

Users guide

Quick start

“...the number of UNIX installations has grown to 10, with more expected...”

Dennis Ritchie and Ken Thompson - June 1972

1.1	Quick start	5
1.2	Quick start in Windows	5
1.3	Quick start on macOS	7
1.4	Quick start on Linux	8
1.5	MIT License	10
1.6	Previous knowledge	10
1.7	And now what?	11

1.1. Quick start

NAppGUI is an SDK to develop software projects, that work on any desktop platform (Windows, macOS or Linux), using the C programming language (Figure 1.1). C++ is allowed, but not indispensable. We can write a complete program using only ANSI-C.

1.2. Quick start in Windows

Before starting you need to have these tools installed (Figure 1.2):

- Visual Studio¹ to compile under Windows. Microsoft offers the free *Community* version.

¹<https://visualstudio.microsoft.com/vs/>

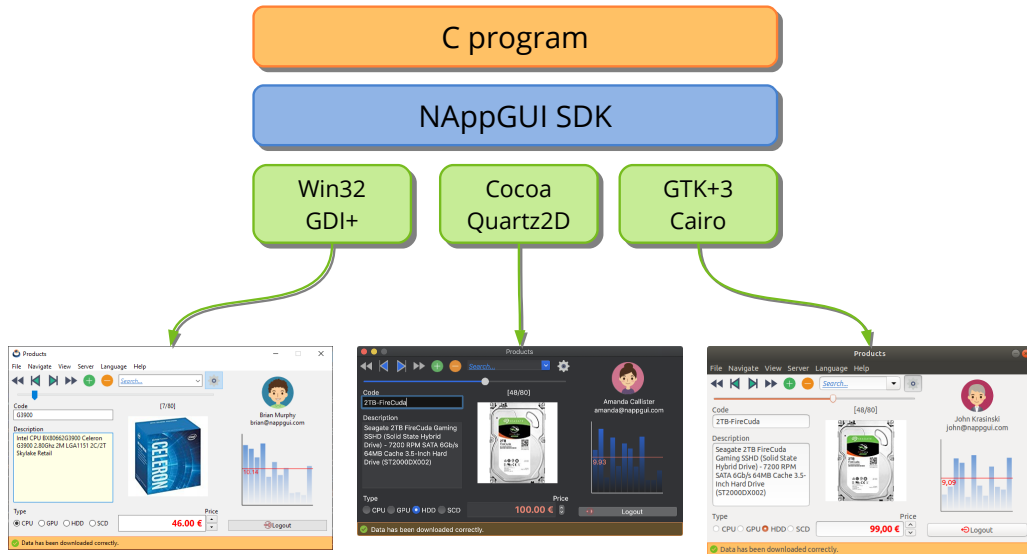

Figure 1.1: NAppGUI allows the easy port of applications written in ANSI C.

- CMake². Cross-platform tool to create compilation projects automatically, from source code. Be careful to select *Add CMake to the system PATH for all users* during installation (Figure 1.3).
- Git³. For download the project from GitHub.



Figure 1.2: Basic tools in Windows.

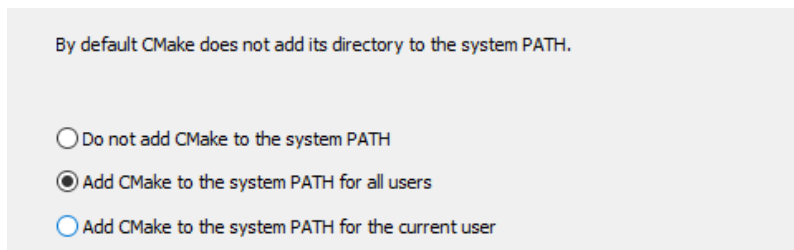

Figure 1.3: Access to CMake from the command line.

From a console on Windows:

²<https://cmake.org/download/>

³<https://git-scm.com/>

```
git clone --depth 1 https://github.com/frang75/nappgui_src.git
cd nappgui_src
cmake -S . -B build
cmake --build build --config Debug
```

Once compiled, you will be able to run the existing example applications in the `\build\Debug\bin` directory (Figure 1.4).

```
.\build\Debug\bin\Die.exe
.\build\Debug\bin\Bricks.exe
.\build\Debug\bin\Products.exe
.\build\Debug\bin\Col2dHello.exe
.\build\Debug\bin\GuiHello.exe
...
```

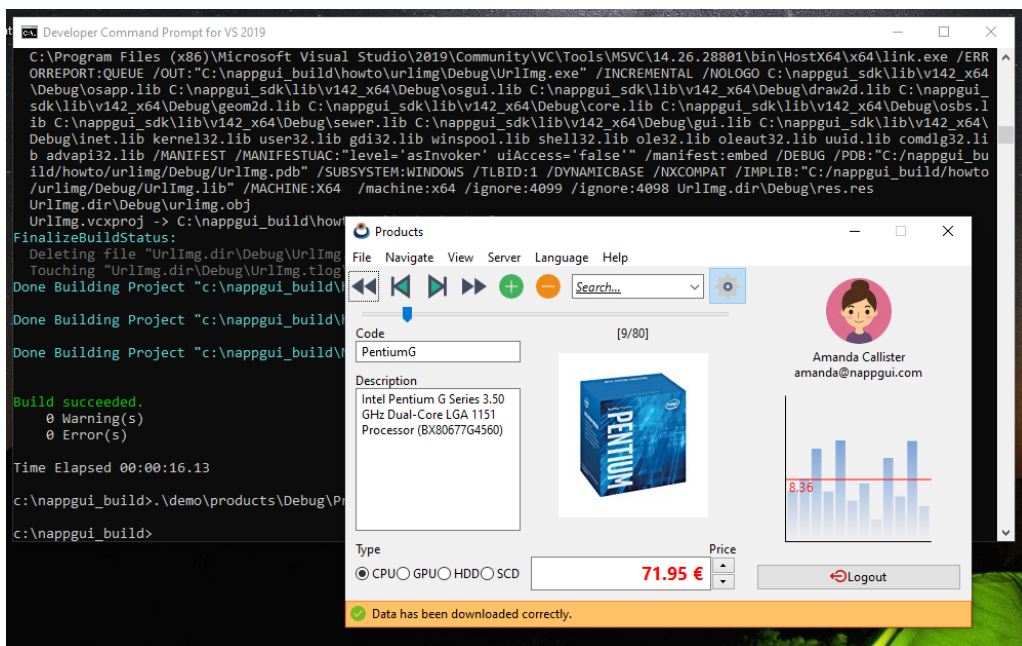

Figure 1.4: Running the `Products` sample program after compilation.

1.3. Quick start on macOS

Before starting, make sure you have installed and configured Xcode⁴, an essential environment for development under macOS. You will also need to download and install CMake from www.cmake.org⁵ (Figure 1.5).

⁴<https://developer.apple.com/xcode/>

⁵<https://www.cmake.org>



Figure 1.5: Xcode and CMake on macOS.

*By default, CMake does not configure command line access on macOS. You can create symbolic links with **sudo “/Applications/CMake.app/Contents/bin/cmake-gui” –install**.*

Open a terminal in macOS:

```
git clone --depth 1 https://github.com/frang75/nappgui_src.git
cd nappgui_src
cmake -G Xcode -S . -B build
cmake --build build --config Debug
```

Once compiled, you can run the existing sample applications in the `/build/Debug/bin` directory (Figure 1.6).

```
./build/Debug/bin/Die.app/Contents/MacOS/Die
./build/Debug/bin/Bricks.app/Contents/MacOS/Bricks
./build/Debug/bin/Products.app/Contents/MacOS/Products
./build/Debug/bin/Col2dHello.app/Contents/MacOS/Col2dHello
./build/Debug/bin/GuiHello.app/Contents/MacOS/GuiHello
...
```

1.4. Quick start on Linux

Before starting, make sure you have the necessary compilers, tools and libraries installed:

```
// Development tools
sudo apt-get install build-essential
sudo apt-get install git
sudo apt-get install cmake

// Development libraries (*)
sudo apt-get install libgtk-3-dev // Mandatory Gui
↳ Toolkit
sudo apt-get install libcurl4-openssl-dev // For HTTP support
sudo apt-get install libwebkit2gtk-4.1-dev // For WebView support
sudo apt-get install mesa-common-dev libegl-mesa-dev // For OpenGL support
```

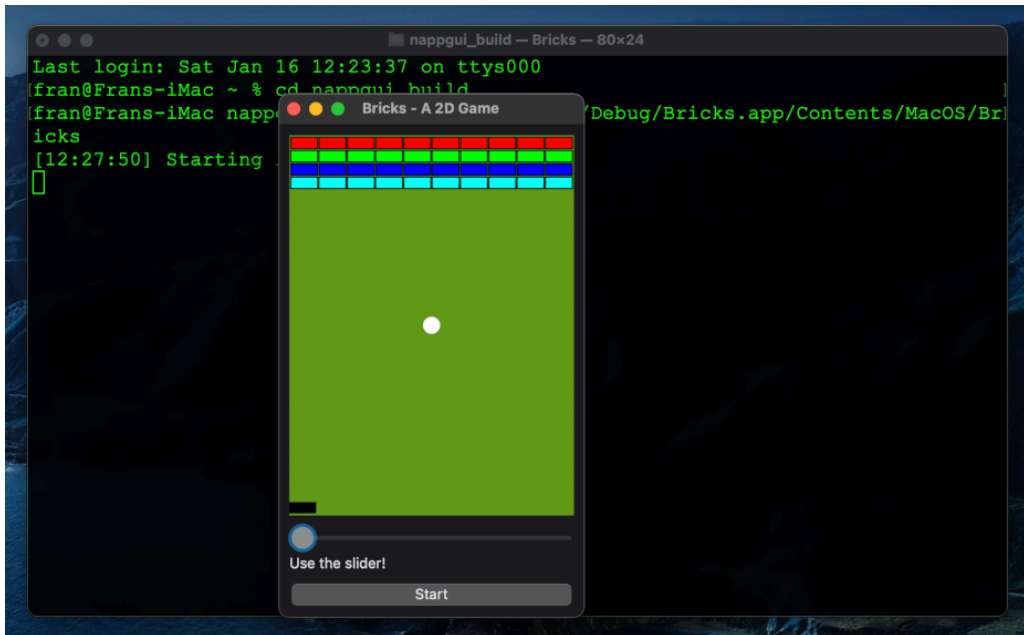

Figure 1.6: Running the **Bricks** sample program after compilation.

() Explicitly installing these libraries is only necessary on machines that are going to compile applications based on NAppGUI. To run the applications it is not necessary to install anything, since the production versions of these libraries are found naturally in most Linux distributions.*

Open a terminal:

```
git clone --depth 1 https://github.com/frang75/nappgui_src.git
cd nappgui_src
cmake -S . -B build -DCMAKE_BUILD_TYPE=Debug
cmake --build build -j 4
```

Once compiled, you will be able to launch the existing example applications in the `/build/Debug/bin` directory (Figure 1.7).

```
./build/Debug/bin/Die
./build/Debug/bin/Bricks
./build/Debug/bin/Products
./build/Debug/bin/Col2dHello
./build/Debug/bin/GuiHello
...
```

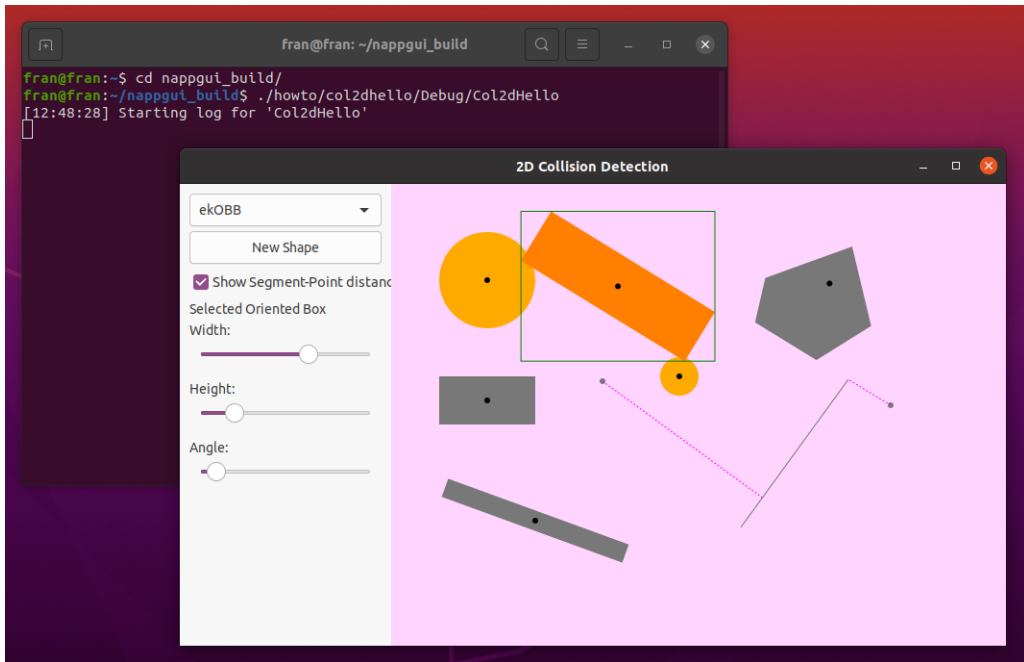

Figure 1.7: Running the `Col2dHello` sample program after compilation.

1.5. MIT License

NAppGUI is distributed under the MIT license, which essentially means that you have complete freedom to use this software freely and for free, both in commercial and free projects. The only restriction is that you must include a copy of this License⁶ in every substantial part of the software you distribute.

1.6. Previous knowledge

This book is not intended for beginners. Although the NAppGUI project is aimed at simplifying the construction of cross-platform applications, it requires certain prior knowledge on the part of the user. You will need, at least, to be fluent in C or C++ since at no time we will stop to explain basic programming concepts. If you come from Java or C#, you should review **pointers**. You will also need some skill with Visual Studio and Xcode development environments, and Unix tools such as `gcc`, `make` or the command interpreter.

On the other hand, if you are an advanced user, you will find a simple system to create very fast and small C applications that will compile without changes in all desktop

⁶<https://www.nappgui.com/en/legal/license.html>

environments. You will also have at your disposal a set of precompiled C libraries to create user interfaces or command line applications, without the need to mess up your projects with the cumbersome class templates that **stl** or **boost** provide.

1.7. And now what?

- In “*Welcome to NAppGUI*” (page 13) we continue with the tutorial.
- In “*Hello World!*” (page 23) we see the minimal code of a desktop application.
- In “*Build NAppGUI*” (page 65) we see how to compile and install NAppGUI.
- In “*Create new application*” (page 71) you will start creating your own applications.
- In “*NAppGUI API*” (page 151) you have the documentation of the libraries and functions.
- In “*Products*” (page 465) you have the source code of a medium-sized application.

Welcome to NAppGUI

*While others were content to write programs that just solved problems, early hackers were obsessed with writing programs that solved problems well. A new program that achieved the same result as an existing one but used fewer punch cards was considered better, even if it did the same thing. The fundamental difference was how the program achieved its result. - **elegance**.*

Jon Erickson - Hacking: The Art of Exploitation

2.1	Welcome to NAppGUI	13
2.2	Original APIs	15
2.3	C-based	16
2.4	No visual editors	16
2.5	Dependencies	18
2.6	Low and high level	21

2.1. Welcome to NAppGUI

NAppGUI is an SDK for creating cross-platform native applications in C. By **native software** we understand that which is compiled/assembled using the specific instructions of the CPU (it is not interpreted or used bytecode) and by **cross-platform** the ability to build versions for Windows, macOS, and Linux using the same source code base (Figure 2.1). Since its first functions written in August 2010, the main objective of NAppGUI has been to simplify as much as possible the arduous task of creating applications with a graphical interface in C. Although different solutions already exist, we have opted for simplicity by creating a light abstraction layer that encapsulates native technologies, unifies them under the same API and adds some logic for task management and automation.

Being somewhat more specific, the philosophy on which the project is based and some of its characteristics are:

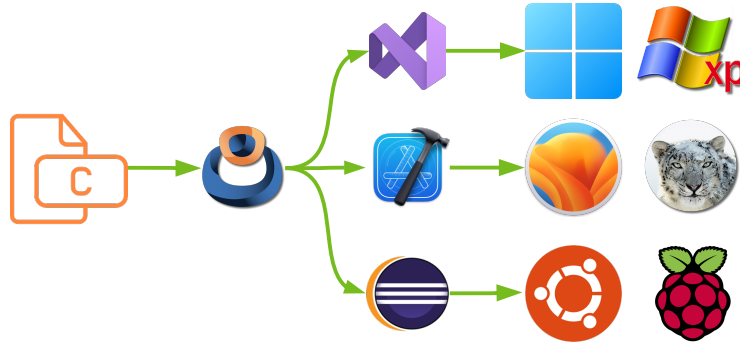

Figure 2.1: Native cross-platform development with NAppGUI.

- Rapid prototyping, evolution and maintenance in **real** applications, apart from the simple examples we find in the literature and the Internet.
- The user interface is described using ANSI-C functions, completely eliminating visual design. This fact facilitates the creation of dynamic interfaces, guarantees portability and enables access to the API from any programming language.
- Windows are composed and sized automatically, without the programmer having to explicitly indicate the coordinates and size of the controls.
- It is possible to have a complete application in a single `.c` file, by removing the usual resource files (`*.rc`, `*.xvid`, etc) and their associated controllers. The programmer has complete freedom when defining his own file structure.
- Automatic synchronization of internal data structures with the interface or with I/O channels. *“Data binding”* (page 233).
- Unified management of resources which facilitates internationalization. *“Resources”* (page 99).
- Translations between languages at runtime without the need to restart the application. *“Runtime translation”* (page 104).
- The compiled version of NAppGUI occupies less than 1Mb, and is distributed in several static libraries that generate very small executables. This is a great advantage over other solutions that require the distribution of heavy *.DLLs*, sometimes larger than the application itself.
- Native Appearance: The applications will be integrated into each system respecting their original aesthetic (Figure 2.2).

- *Backends.* The NAppGUI core provides structures and objects for creating highly efficient command-line applications on Windows or Linux servers.

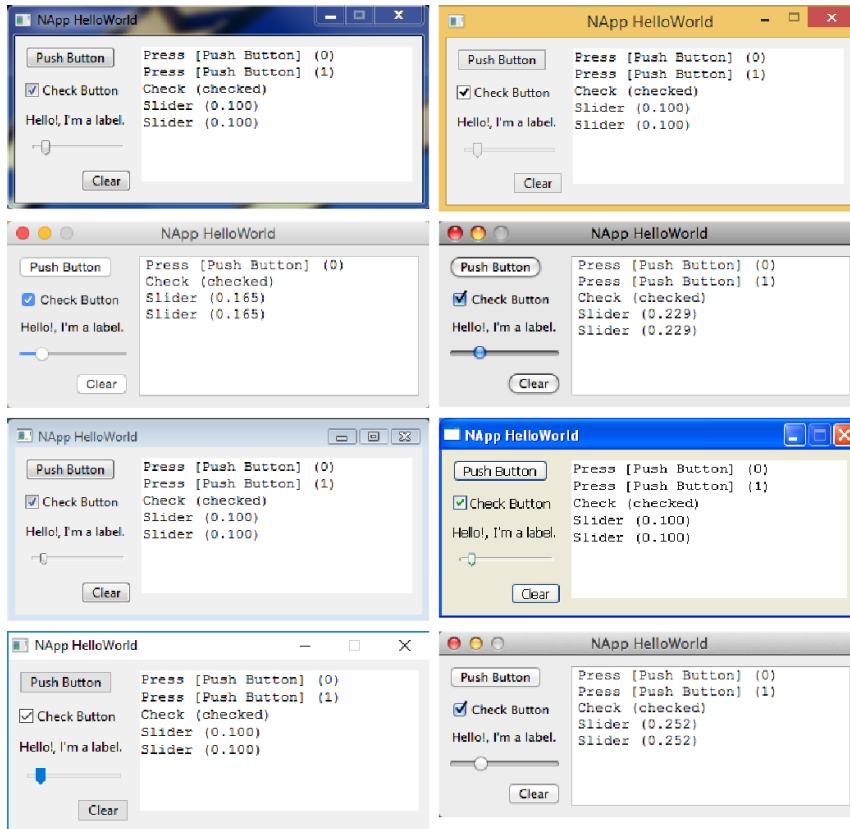

Figure 2.2: Native appearance of the *Hello, World!* demo.

2.2. Original APIs

Microsoft, Apple and GNU/Linux propose different APIs to interact with their systems. This means that the same application must be rewritten to work correctly on each platform. NAppGUI provides a unified set of functions for creating graphical user interfaces and allowing direct access to machine resources (memory, disk, network, etc.) (Figure 2.3). Each implementation takes into account the particular conditions of the target platform and uses the appropriate native commands to perform the task in the most optimal way possible.

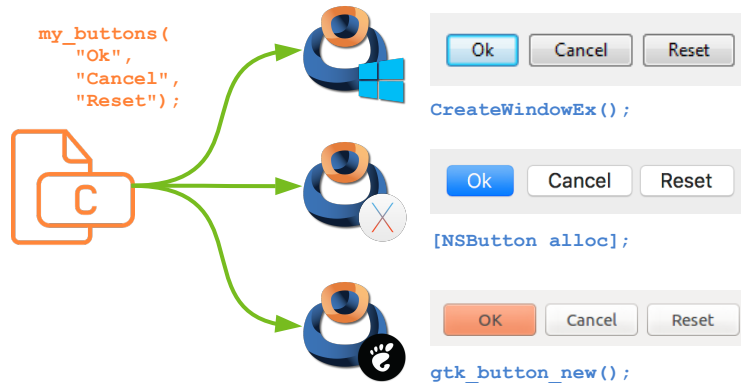

Figure 2.3: Calls to the native APIs, from the source code itself.

2.3. C-based

Despite the fact that today we have a large number of programming languages, the C language is still the most powerful and portable in the world. The core of Windows, macOS, Linux, Android, iOS, and other major programs are largely written in C. In the world of apps, its use has waned a bit in favor of more *glamour*. Perhaps this is one of the reasons why Wirth's law¹ is more and more true every day.

“Software slows down faster than hardware speeds up.”

NAppGUI is written, almost entirely, in C language with small parts in C++ and Objective-C. This language is widely supported and cross-platform compatible. In its development we have dispensed with minority, proprietary or brand-linked languages such as: C#, Swift, Java or Objective-C. Also interpreted (such as Python or JavaScript) and those based on virtual machines (Java and C#) due to the performance penalty (Figure 2.4). Finally, we have not used C++, since we do not present NAppGUI as a hierarchy of classes but as a library of functions. Our goals have been to minimize the impact of the SDK, simplify programming, increase readability, and produce high-performance binaries.

2.4. No visual editors

The creation of graphical interfaces can become a tedious process, since it is difficult to know in advance the final size of elements that contain text or images, such as buttons. On the other hand, windows are dynamic entities subject to changes at runtime (size, translation, changing subpanels, hidden areas, etc.). When using a visual editor, we have

¹https://en.wikipedia.org/wiki/Wirth%27s_law



Figure 2.4: Interpreter, virtual machine, and binary code. The closer we get to machine language, the more performance we will get from the software.

to place elements at the exact position and size (Figure 2.5). This is a mouse-intensive task, which slows down the connection between GUI objects and event handlers. In the development cycle, if the texts or other elements change (and of course they will), we will have to relocate the components by hand again. This problem grows in multilingual solutions. Keeping developers moving pixels and filling property forms is expensive for companies and very boring for them. This is not to mention that all of these visual designs will not be cross-platform compatible (.rc Windows, .xib macOS, .glade GTK/Gnome, etc.).

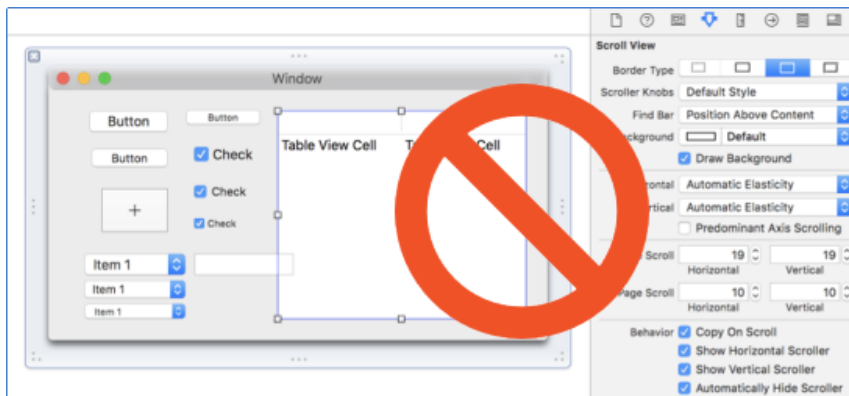

Figure 2.5: Resource editors are not good friends for creating complex dynamic interfaces.

Many programmers prefer not to move their hands from the keyboard, since they consider it much more productive.

NAppGUI uses a declarative strategy, where it is only necessary to indicate the cell where the element will be located within a rectangular grid (`Layout`). The final size and position will be calculated at runtime, performing a recursive composition of the `layouts` and `sublayouts` based on their content (Listing 2.1) (Figure 2.6).

Listing 2.1: Creating a window.

```

Panel *panel = panel_create();
Layout *layout = layout_create(1, 3);
Label *label = label_create();
Button *button = button_push();
TextView *view = textview_create();
Window *window = window_create(ekWINDOW_STD);
label_text(label, "Hello!, I'm a label");
button_text(button, "Click Me!");
layout_label(layout, label, 0, 0);
layout_button(layout, button, 0, 1);
layout_textview(layout, view, 0, 2);
layout_hsize(layout, 0, 250);
layout_vsize(layout, 2, 100);
layout_margin(layout, 5);
layout_vmargin(layout, 0, 5);
layout_vmargin(layout, 1, 5);
panel_layout(panel, layout);
window_panel(window, panel);
window_title(window, "Hello, World!");

```

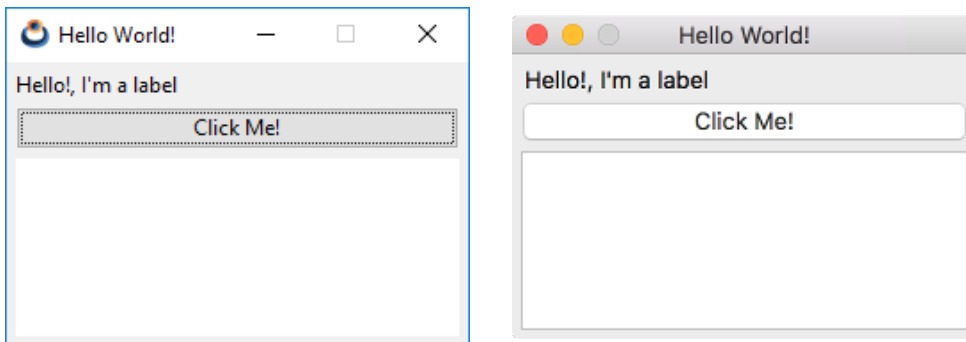

Figure 2.6: Declarative composition is fast, adaptable, and portable.

2.5. Dependencies

NAppGUI does not use third-party libraries, it only connects with the native APIs of each operating system. This fact, together with the use of C and static linking, makes it possible to:

- Applications don't need additional runtimes like Python, Java, or C# do. They go directly to the CPU via the system *scheduler*.
- The entire application can be contained in a single `.exe` file. As little code as possible is linked and no additional `.dll` need to be distributed. Starting with version 1.3, NAppGUI can be compiled as dynamic libraries.

- Applications take up very little disk space, since all their dependencies are naturally present on the systems where they run.
- The performance is maximum, since they are compiled in native machine code, using the highest level of optimization that each CPU supports.
- They can be edited, compiled and run on obsolete platforms today like a Pentium III with Visual Studio 2005 and WindowsXP.
- With NAppGUI we can move them from Windows to macOS or Linux, without touching a single line of source code. See “*Generators, compilers and IDEs*” (page 114).

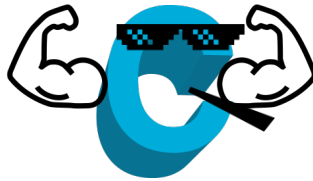

Three packages within the SDK will act as technology *wrappers* (Figure 2.7), hiding platform-specific details under a common interface, without causing overhead to the program.

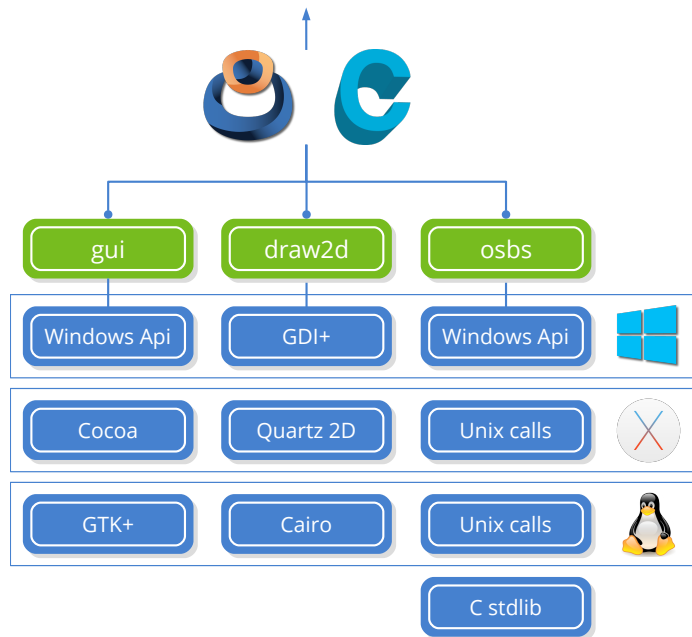

Figure 2.7: Different technologies at the base of NAppGUI. In “*NAppGUI API*” (page 151) you have the complete schematic.

- “*Osbs*” (page 174): *Operating System Basic Services*. API about files and directories, processes, threads, memory, etc.
- “*Draw2D*” (page 264): API for 2d vector drawing, images and fonts.

- “*Gui*” (page 305): API about graphical interfaces: Windows, controls and menus.
- **Unix system calls:** In Unix-like systems (Linux, macOS) it is the way in which a program communicates with the kernel to perform some task related to files, processes, memory, network or hardware usually.
- **Windows API:** It is the lowest level API provided by Microsoft for programming under Windows. It is very broad and integrates different aspects of development:
 - kernel32.dll: The equivalent of Unix calls (files, processes, memory, etc).
 - ws2_32.dll: Provides TCP/IP network functions (Unix calls include TCP/IP support).
 - user32.dll, comctl32.dll, comdlg32.dll, uxtheme.dll: Implements standard controls for graphical user interfaces (labels, edit boxes, combos, progress bars, common dialogs, etc.).
- **Cocoa:** Object-oriented programming API for Mac OSX (now macOS) systems. It is written in Objective-C, therefore it is not directly accessible from “pure” C. Cocoa is based on OpenStep, the API of NeXTSTEP, the operating system created by Steve Jobs when he was fired from Apple. In 1996, Apple buys NeXT and gets Jobs back, using Jobs’ technology as the basis for the new Macintosh. Many classes in Cocoa still retain the NS prefix as NeXTSTEP inheritance. Although there is a lower level C-based API called Carbon, it has been discontinued since Mac OSX 10.4 Tiger. It does not have access to all system functionality nor is it compatible with 64-bit applications. Thus, Cocoa is the current lowest level API for Apple systems.
- **Gtk+:** Acronym for **GIMP ToolKit**. It is a high-level library for creating graphical interfaces with a multitude of predefined objects (called *widgets*). It is one of the most widespread in GNU/Linux systems, but it is actually multiplatform with versions for Windows and macOS. Desktop environments like Gnome, Xfce or applications like GIMP are based on GTK.
- **GDI+:** It is the evolution of GDI (*Graphics Device Interface*), a 2d vector drawing API developed by Microsoft for the first 16-bit version of Windows. GDI+ was introduced with Windows XP as a set of C++ classes and is encapsulated in the .NET platform via the `System.Drawing` namespace. It is also accessible directly from C via the *GDI+ Flat API*, but Microsoft recommends using it via C++ classes. It incorporates substantial improvements over GDI, such as floating point coordinates, affine transformations, anti-aliasing, gradient shading, and support for image formats such as JPG, PNG, or GIF. Drawing with masks and incompatibility with PDF are the two most notable drawbacks compared to Quartz 2D and Cairo, its direct “competitors” on other platforms.
- **Quartz 2D:** It is the trade name of *Core Graphics*, the powerful drawing API

of macOS. Like Cocoa, Core Graphics is an evolution of the NeXTSTEP graphics libraries and came to Apple after the NeXT acquisition. Quartz 2D is based on Adobe PostScript and PDF formats, incorporating alpha channel and anti-aliasing. Classic Macs (pre-NeXT) used the *QuickDraw* library, originally developed by Bill Atkinson for the Apple Lisa. Modern macs still have QuickDraw built in, but Xcode no longer provides headers, so it can't be used in new projects. Core Graphics is a C-based API and all of its functions begin with the **CG** prefix.

- **Cairo:** Cairo is a C-based 2d vector drawing library. Unlike GDI+ or Quartz 2D, it is cross-platform, can be downloaded independently and incorporated into any project (under LGPL license). Since version 3, GTK+ uses Cairo for all widget drawing tasks. GTK+2 also used Cairo to generate PDF documents for printing. NAppGUI uses Cairo to implement the **draw2d** API on the GNU/Linux platform, as this library is found naturally in all GTK+ based desktop environments: Gnome, Cinnamon, LXDE, Mate, Pantheon, Sugar or Xfce. Technically, Cairo is quite advanced, matching Quartz 2D in terms of functionality. It supports affine transformations, image masks, bezier curves, text processing, and drawing on PDF and PostScript surfaces.
- **C stdlib:** C is a beautiful little language, but it doesn't provide any additional support functions. During the 1970s, the C language became very popular and users began to share ideas on how to solve common and repetitive tasks. With its standardization in the 1980s, some of these ideas became the C standard library, which provides a basic set of mathematical functions, string manipulation, type conversions, and input/output. NAppGUI integrates in one way or another the functionality of the standard library, so we do not recommend its use in final applications (see "*Sewer*" (page 156)).

2.6. Low and high level

During its design and implementation, NAppGUI has tried to maintain a balanced balance between low-level and high-level programming. Low-level lovers will find a kind of *extended and cross-platform C library* to access the system, interface elements and drawing commands. However, they will still retain the power to create optimized code and direct memory access. Remember, we are in C!

On the other hand, NAppGUI integrates some high-level solutions such as resource management, interface composition, automatic translations or data binding, among others. NAppGUI also incorporates CMake scripts for automated project creation in Visual Studio, Xcode, or Eclipse/Make.

Finally, it is the developers who decide which libraries to link with according to the needs of the project and the degree of automation they wish to adopt. Each application based on

NAppGUI performs a static link of all its dependencies, so neither the executable nor its final distribution will have traces of unnecessary binary code. In this way, we will produce small self-contained executables that will not require an installer or include megabytes of dependencies in the form of .DLLs.

Hello World!

Once upon a time, there was a company called Taligent. Taligent was created by IBM and Apple to develop a set of tools and libraries like Cocoa. About the time Taligent reached the peak of its mindshare, Aaron met one of its engineers at a trade show and asked him to create a simple application: A window appears with a button. When the button is clicked, the words “Hello, World!” appear in a text field. The engineer created a project and started subclassing madly, subclassing the window and the button and the event handler. Then he started generating code: dozens of lines to get the button and the text field onto the window. After 45 minutes, he was still trying to get the app to work. A couple of years later, Taligent quietly closed its doors forever.

Hillegass, Preble & Chandler - Cocoa Programming for OSX.

3.1	Hello World!	23
3.2	The complete program	24
3.3	The skeleton	26
3.4	The constructor	27
3.5	The main panel	28
3.6	The destructor	28
3.7	Launch the window	28
3.8	Layout format	29
3.9	Exiting the program	29
3.10	Button Events	30

3.1. Hello World!

There is little we can say about the meaning of the *Hello World!* program every time we are faced with a new technology or programming methodology. So, let’s get down to business.

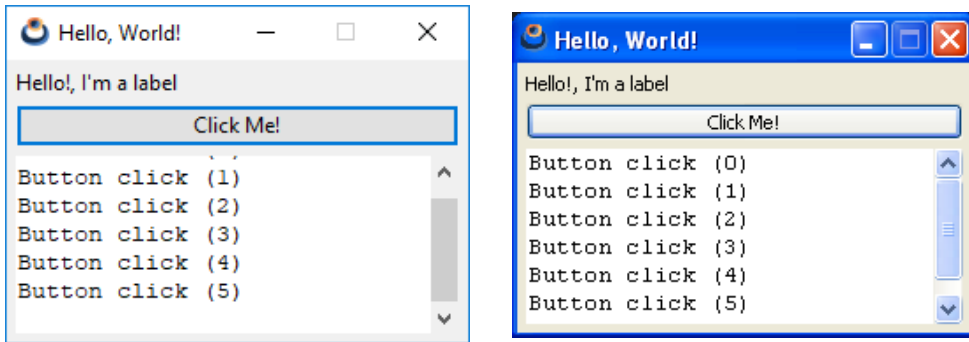

Figure 3.1: Windows 10 y Windows XP.

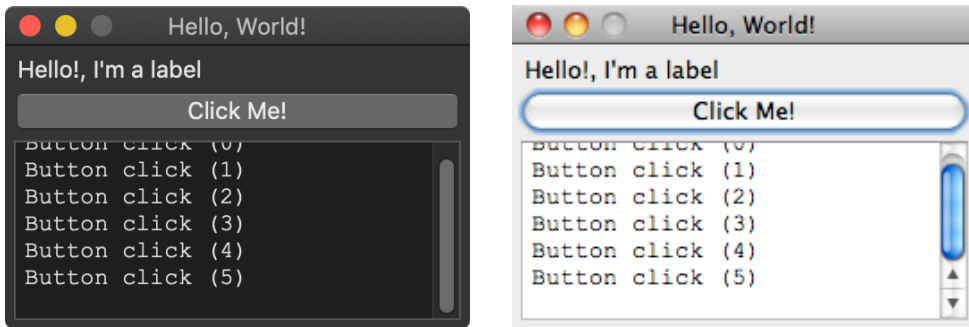

Figure 3.2: macOS 10.14 Mojave and MacOSX 10.6 Snow Leopard.

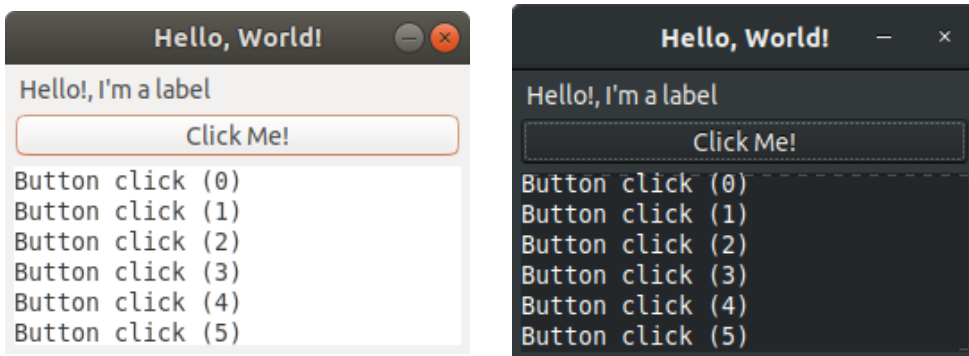

Figure 3.3: GTK+3 Ambiance (Ubuntu) and Adwaita Dark (Raspbian).

3.2. The complete program

Listing 3.1: demo/hello/main.c

```
/* NAppGUI Hello World */
#include <nappgui.h>
```

```

typedef struct _app_t App;

struct _app_t
{
    Window *window;
    TextView *text;
    uint32_t clicks;
};

/*-----*/

static void i_OnButton(App *app, Event *e)
{
    textview_printf(app->text, "Button click (%d)\n", app->clicks);
    app->clicks += 1;
    unref(e);
}

/*-----*/

static Panel *i_panel(App *app)
{
    Panel *panel = panel_create();
    Layout *layout = layout_create(1, 3);
    Label *label = label_create();
    Button *button = button_push();
    TextView *text = textview_create();
    app->text = text;
    label_text(label, "Hello!, I'm a label");
    button_text(button, "Click Me!");
    button_OnClick(button, listener(app, i_OnButton, App));
    layout_label(layout, label, 0, 0);
    layout_button(layout, button, 0, 1);
    layout_textview(layout, text, 0, 2);
    layout_hsize(layout, 0, 250);
    layout_vsize(layout, 2, 100);
    layout_margin(layout, 5);
    layout_vmargint(layout, 0, 5);
    layout_vmargint(layout, 1, 5);
    panel_layout(panel, layout);
    return panel;
}

/*-----*/

static void i_OnClose(App *app, Event *e)
{
    osapp_finish();
    unref(app);
    unref(e);
}

```

```

}

/*-----*/

static App *i_create(void)
{
    App *app = heap_new0(App);
    Panel *panel = i_panel(app);
    app->window = window_create(ekWINDOW_STD);
    window_panel(app->window, panel);
    window_title(app->window, "Hello, World!");
    window_origin(app->window, v2df(500, 200));
    window_OnClose(app->window, listener(app, i_OnClose, App));
    window_show(app->window);
    return app;
}

/*-----*/

static void i_destroy(App **app)
{
    window_destroy(&(*app)->window);
    heap_delete(app, App);
}

/*-----*/

#include "osmain.h"
osmain(i_create, i_destroy, "", App)

```

3.3. The skeleton

A NAppGUI application starts at `osmain`, a cross-platform macro that unifies the startup of a desktop program under different systems. It is defined in `#include "osmain.h"` and will receive four parameters: constructor, destructor, arguments (`char_t`), and the object type. In this way, any basic skeleton looks like this:

```

#include "nappgui.h"

typedef struct _app_t App;
struct _app_t
{
    Window *window;
};

static App *i_create(void)
{
    App *app = heap_new0(App);
    return app;
}

```

```

}

static void i_destroy(App **app)
{
    heap_delete(app, App);
}

#include "osmain.h"
osmain(i_create, i_destroy, "", App)

```

The `#include "nappgui.h"` directive, includes much of NAppGUI with a single statement. If you prefer, you can choose to include the headers separately as needed. In this case, we should replace a single `#include` with eleven. In the Reference Manual, it is indicated which header to include according to the function module that we are going to use.

```

#include <gui/button.h>
#include <gui/gui.h>
#include <gui/label.h>
#include <gui/layout.h>
#include <gui/panel.h>
#include <gui/textview.h>
#include <gui/window.h>
#include <geom2d/v2d.h>
#include <core/event.h>
#include <core/heap.h>
#include <core/strings.h>

```

3.4. The constructor

The first parameter of `osmain` is the application constructor. As soon as the program starts, certain internal structures must be initialized, as well as starting the message loop inherent to all desktop applications. When everything is ready, the constructor will be called to create the **application object**. This object can be of any type and does not need to be derived from any `class Application` or similar, we are in C ;-). Because of the simplicity of this example, the application object contains only one window.

```

static App *i_create(void)
{
    App *app = heap_new0(App);
    Panel *panel = i_panel(app);
    app->window = window_create(ekWINDOW_STD);
    window_panel(app->window, panel);
    return app;
}

```

3.5. The main panel

To create the main window, we need the **main panel**, a container that integrates all the interface controls displayed in the window. The space inside the panel is organized in an invisible grid called `Layout`. Each panel can have several layouts and switch between them, but at least one is necessary. Within its cells we will locate the different widgets.

```
static Panel *i_panel(App *app)
{
    Panel *panel = panel_create();
    Layout *layout = layout_create(1, 3);
    Label *label = label_create();
    Button *button = button_push();
    TextView *text = textview_create();
    label_text(label, "Hello!, I'm a label");
    button_text(button, "Click Me!");
    layout_label(layout, label, 0, 0);
    layout_button(layout, button, 0, 1);
    layout_textview(layout, text, 0, 2);
    panel_layout(panel, layout);
    return panel;
}
```

3.6. The destructor

When the application terminates, `osmain` will call the destructor (second parameter of the macro) to free the application object and everything that depends on it, in order to perform a clean exit of the program. We will put **a lot of emphasis on this**, as failure to properly free all memory will be considered a serious programming error.

```
static void i_destroy(App **app)
{
    window_destroy(&(*app)->window);
    heap_delete(app, App);
}
```

3.7. Launch the window

By default, `NAppGUI` creates all windows in hidden mode, so you need to display them explicitly. We establish a title, an initial position and launch it with `window_show`. We observe that in this first version our window is not very aesthetically pleasing (Figure 3.4). We will format it in a moment.

```
static App *i_create(void)
{
    ...
}
```

```

window_title(app->main_window, "Hello World!");
window_origin(app->main_window, v2df(500, 200));
window_show(app->main_window);
...
}

```

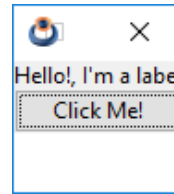

Figure 3.4: First version of *Hello, World!* (without format).

3.8. Layout format

To improve the appearance of our window, let's format the layout a bit. Specifically, we are going to set a column width and a height for the third row (text control). Then we will leave a margin on the edge and a separation between rows. (Figure 3.5).

```

layout_hsize(layout, 0, 200);
layout_vsize(layout, 2, 100);
layout_margin(layout, 5);
layout_vmargin(layout, 0, 5);
layout_vmargin(layout, 1, 5);

```

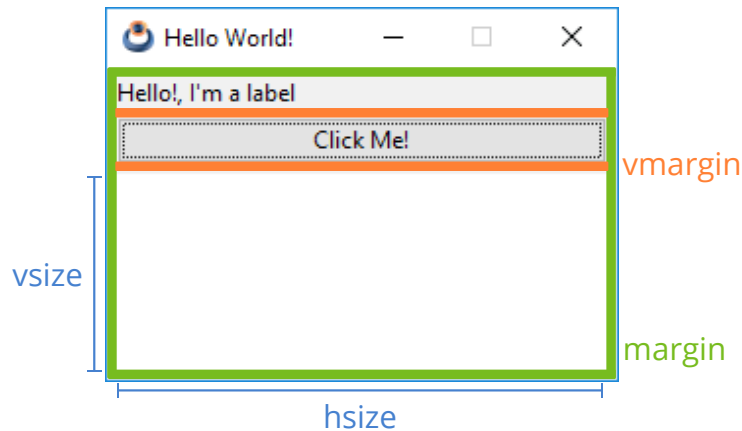

Figure 3.5: *Hello World!* after Layout formatting.

3.9. Exiting the program

When we press the button to close the main window, the program does not finish its execution. This is typical of macOS applications, where they still continue running in the

Dock even if there is no window open. NAppGUI follows the same criterion of not closing the program, so we must make an explicit call to the `osapp_finish` function. To do this, we will capture the `window_OnClose` event using the `listener` macro.

```
static void i_OnClose(App *app, Event *e)
{
    osapp_finish();
}

static App *i_create(void)
{
    window_OnClose(app->main_window, listener(app, i_OnClose, App));
}
```

3.10. Button Events

Finally, we'll catch the *click* event of the button and print a message in the text box each time it's clicked. We are going to implement the `i_OnButton` handler, responsible for composing and displaying the message, and connect it to the Button control we created earlier.

```
static void i_OnButton(App *app, Event *e)
{
    textview_printf(app->text, "Button click (%d)\n", app->clicks);
    app->clicks += 1;
    unref(e);
}
...
button_OnClick(button, listener(app, i_OnButton, App));
```

An event is an action that occurs during the execution of the program. The operating system captures it and sends it to us through its callback(defined in `listener()`). More at “Events” (page 237).

Use of C

Most programming languages contain good parts and bad parts. I discovered that I could be a better programmer by using only the good parts and avoiding the bad parts. After all, how can you build something good out of bad parts?

Douglas Crockford - JavaScript: The Good Parts.

4.1	Use of C	31
4.2	Basic types	32
4.3	Structures and unions	34
4.4	Control	35
4.5	Functions	37
4.6	Scopes	38
4.7	Pointers	39
4.8	Preprocessor	40
4.9	Comments	41
4.10	Input/Output	42
4.11	Mathematical algorithms	43

4.1. Use of C

Programming fast, reducing the probability of error, ensuring portability and generating optimized binaries have been the main purposes of NAppGUI since its inception and that includes a revision of the C language itself. A **subset of ANSI-C90** with fixed-size integers `<stdint.h>`, a feature introduced in C99, has been used as a base language. We recommend that applications based on this SDK follow the same philosophy. Going into more detail, the objectives pursued have been these:

- **Maximum portability:** Even on already outdated compilers like MSVC 8.0 (Visual Studio 2005) or GCC 4.2 (Xcode 3). The latest language features may not be available on platforms where you must port your code (think embedded devices). You also ensure that such code will be compatible with future versions of major compilers.
- **Focus attention:** On the “what” and not on the “how”. There are times when we make the simple complicated just to justify the use of that new “cool” feature. It is also possible that you are a “hip” addict, which will force you to “modernize” the code to adapt it to a new version of the standard. Focus on solving the problem at hand and, if you can, spend more time on lowering the asymptotic complexity of your solution. NAppGUI will make sure that your applications work wherever they are needed.
- **Avoid irrelevant features:** Like C11’s multi-threading support (`<threads.h>`). This is solved with system calls. See “*Threads*” (page 178).
- **Fast compilation:** Certain C constructs are nothing more than a kind of “portable assembler”, which the compiler can interpret and translate incredibly efficiently.
- **Small and fast binaries:** Derived from the previous one, the generated code will require few assembly statements and will be very easy for the compiler to optimize.

Evidently, this is not the place to learn C nor is it our intention. The core of the language is small and easy to remember, but programming well requires years of practice. What we will do here is show the minimum expression of the language that we use daily. In short, these are our standards.

4.2. Basic types

- **Void:** `void`.
- **Boolean:** `bool_t`. 8-bit type with only two possible values `TRUE` (1) and `FALSE` (0).
- **Integers:** `uint8_t`, `uint16_t`, `uint32_t`, `uint64_t`, `int8_t`, `int16_t`, `int32_t`, `int64_t`. Fixed-size integers were introduced in C99 by `<stdint.h>`. We consider it an advantage to know that our variables will have the same size in all systems. The use of `int`, `long`, `short` or `unsigned` is prohibited, with the sole exception of the comparison functions .

```
static int i_cmp_cir(const Cir2Dd *cir1, const Cir2Dd *cir2)
{
    return (cir1->r < cir2->r) ? 1 : -1;
}

arrst_sort(circles, i_cmp_cir, Cir2Dd);
```

- **Floating point:** `real32_t`, `real64_t`. `float` and `double` are not used for consistency with integer types.
- **Character:** `char_t` (8 bits). The UTF8 representation is used “de facto” throughout the SDK, so random access to elements of a string is prohibited, since it is a variable-length encoding. Functions included in “*Unicode*” (page 161) or “*Strings*” (page 200) must be used to manipulate arrays of characters. The types `wchar_t`, `char16_t`, `char32_t` are not used (or recommended). However, if you have *wide-char* strings you will need to convert them to UTF8 before using them in any NAppGUI functions.

Using UTF8 strings

```

/* Error! */
const char_t *mystr = "Ramón tiene un camión";
while (mystr[i] != '\0')
{
    if (mystr[i] == 'ó')
    {
        /* Do something */
    }
    else
    {
        i += 1;
    }
}

/* Correct! */
const char_t *it = mystr;
uint32_t cp = unicode_to_u32(it, ekUTF8);
while (cp != '\0')
{
    if (cp == 'ó')
    {
        /* Do something */
    }
    else
    {
        it = unicode_next(it, ekUTF8);
        cp = unicode_to_u32(it, ekUTF8);
    }
}

/* Avoid using wchar_t constants (when possible).
   wchar_t uses UTF16 encoding */
const wchar_t *mywstr = L"Ramón tiene un camión";
char_t mystr[512];

unicode_convers((const char_t*)mywstr, mystr, ekUTF16, ekUTF8, sizeof(
    ↪ mystr));

```

```
/* This is a NAppGUI function (UTF8-Encoding) */
label_text(label, mystr);
```

- **Enumerated:** Their main task is to manage the specialization and they will be evaluated exclusively within a switch. It is forbidden to assign random values to the elements of an enum, except 1 to the first one. Consider 0 as **not initialized** and `ENUM_MAX(aligned_t)` as **invalid**.

Defining enumerated types

```
typedef enum _align_t
{
    ekTOP = 1,
    ekBOTTOM,
    ekLEFT,
    ekRIGHT
} align_t;
```

4.3. Structures and unions

Definition of structures and unions

```
typedef struct _layout_t Layout;
typedef union _attr_t Attr;

struct _layout_t
{
    Cell *parent;
    Panel *panel;
    bool_t is_row_major_tab;
    ArrSt(Cell) *cells;
    ArrPt(Cell) *cells_dim[2];
    real32_t dim_margin[2];
    color_t bgcolor;
    color_t skcolor;
};

union _attr_t
{
    struct _bool_
    {
        bool_t def;
    } boolt;

    struct _int_
    {
        int64_t def;
        int64_t min;
        int64_t max;
    };
};
```

```

    int64_t incr;
    String *format;
} intt;

struct _real32_
{
    real32_t def;
    real32_t min;
    real32_t max;
    real32_t prec;
    real32_t incr;
    uint32_t dec;
    String *format;
} real32t;
};

```

In general, structure definitions will not be public and will remain hidden in the *.c. This means that automatic variables cannot be declared in the “*Stack Segment*” (page 169) and will only be accessible by functions that accept **opaque dynamic objects**.

Use of opaque pointers

```

Layout *layout = layout_create(2, 2);
layout_edit(layout, edit, 0, 0);
layout_label(layout, label, 0, 1);
...
panel_layout(panel, layout);

```

```

/* Layout definition is hidden
   We do not know the content of Layout */
Layout layout; /* Compiler error! */

```

Normally, all dynamic objects will have a destroy function. If it does not exist, it is because said object **only makes sense as part of another object**. For example, there is no `layout_destroy()` or `panel_destroy()`, but there is `window_destroy` which will destroy the entire hierarchy of panels and associated layouts to the window.

4.4. Control

- **if/else**. They always open a {...} block, unless ALL paths consist of a single statement. Using functions as arguments to if/else is generally avoided with the exception of **pure functions**.

Use of if/else

```

if (x == 1)
    i_do_something(j);
else

```

```

    i_do_nothing();

if (x == 1)
{
    j += 2;
    i_do_something(j);
}
else
{
    i_do_nothing();
}

if (bmath_sqrtf(sqrlen) < 20.5f)
    i_do_something(j);

```

- **while**. Nothing to comment.
- **do/while**. Not allowed. Use `for` or `while`.
- **for**. For infinite loops, use `for(;;)` instead of `while(TRUE)`, as it avoids warnings in some compilers. Since there are ANSI-C based compilers, such as MSVC++ 8.0, we **do not use variable declarations** inside the `for()`, a feature that was introduced in C99.

Use of for

```

/* Infinite loop */
for(;;)
{
    ...
}

/* Will not work in some compilers (not used) */
for (uint32_t i = 0; i < 1024; ++i)
{
    ...
}

/* Ok */
uint32_t i = 0;
...
for (i = 0; i < 1024; ++i)
{
    ...
}

```

- **switch**. It is only used to discriminate between the values of an **enum**. Any other data type will NEVER be evaluated in a `switch` nor will an `enum` be discriminated within an `if/else` construct. The compiler can drastically optimize the performance of a build with these features.

Use of switch

```

switch(aligned) {
case ekTOP:
    ...
    break;

case ekBOTTOM:
    ...
    break;

case ekLEFT:
    ...
    break;

case ekRIGHT:
    ...
    break;

cassert_default();
}

```

4.5. Functions

- A function can return nothing (`void`), a basic type, or a pointer.
- Input parameters are always **const** even if they are simple types passed by value.
- Any input parameter that is not of basic type will be passed by pointer. Never a structure by value.
- For the output parameters, pointers will always be used. In C there are no references.

Parameters in functions.

```

uint32_t myfunc(const uint32_t input1, const Layout *input2, V2Df *output1
    ↪ , real32_t *output2);

```

- The number of public functions should be kept to a minimum, which will be declared in the `*.h` and defined in the `*.c`.
- Supporting (or private) functions will be defined `static`, inside the `*.c` module and will have no declaration.

Public function.

```

/* layout.h */
void layout_hsize(Layout *layout, const uint32_t col, const real32_t wid);

/* layout.c */

```

```

void layout_hsize(Layout *layout, const uint32_t col, const real32_t wid)
{
    i_LineDim *dim = NULL;
    cassert_no_null(layout);
    cassert_msg(wid >= 0.f, "Column 'width' must be positive.");
    dim = arrst_get(layout->lines_dim[0], col, i_LineDim);
    cassert_no_null(dim);
    dim->forced_size = wid;
}

```

Private function. It can only be called inside `layout.c`.

```

/* layout.c */
static Cell *i_get_cell(Layout *lay, const uint32_t c, const uint32_t r)
{
    uint32_t position = UINT32_MAX;
    cassert_no_null(lay);
    cassert(c < arrst_size(lay->lines_dim[0], i_LineDim));
    cassert(r < arrst_size(lay->lines_dim[1], i_LineDim));
    position = r * arrst_size(lay->lines_dim[0], i_LineDim) + c;
    return arrst_get(lay->cells, position, Cell);
}

```

4.6. Scopes

Variables are declared at the beginning of a block and cannot be mixed with statements, unless we open a new scope. Declarations mixed with statements is a C++ feature added to the C99 standard, but not all C compilers support it. Yes, it is allowed to initialize a variable by calling a function.

Variable scopes in C

```

{
    /* Ok! */
    uint32_t var1 = 5;
    uint32_t var2 = i_get_value(stm);
    uint32_t var3 = i_get_value(stm);

    i_add_values(var1, var2, var3);

    /* Error in C90 compilers */
    uint32_t var4 = 6;

    /* Ok! */
    {
        uint32_t var4 = 6;
        ....
    }
}

```

4.7. Pointers

Apart from the advantages of using pointer arithmetic when implementing certain algorithms, in NAppGUI pointers are used essentially in two situations:

- Passing parameters to a function, when said parameter is not a basic type.

Passing of parameters through pointers.

```
V2Df v1 = v2df(10, 43.5f);
V2Df v2 = v2df(-4.8f, val);
V2Df v3 = v2d_addf(&v1, &v2);

/* v2d.h */
V2Df v2d_addf(const V2Df *v1, const V2Df *v2);
```

- Handling opaque objects. Where the definition of the struct is not available and therefore the only way to communicate with the object is through functions that accept a pointer to it.

Use of opaque objects.

```
const V2Df pt[] = { {4,1}, {2,5}, {-3,5}, {-4,2}, {0,-3} };
Pol2Df *pol = pol2d_createf(pt, 5);
real32_t a = pol2d_areaf(pol);

...
pol2d_destroyf(&pol);

/* pol2d.h */
Pol2Df* pol2d_createf(const V2Df *points, const uint32_t n);

void pol2d_destroyf(Pol2Df **pol);

real32_t pol2d_areaf(const Pol2Df *pol);
```

Special mention should be made of the **function pointers** that are widely used in C, but less so in C++ as the language hides them inside **vtables**. However, a strategically placed function pointer can make it easier for us to add specialized functionality to existing objects, without having to adopt a more purist object-oriented design.

Listing 4.1: Use of function pointers.

```
typedef struct _shape_t Shape;
typedef void (*FPtr_draw)(const Shape*, DCtx *ctx);

struct _shape_t
{
    ArrSt(V2Df) *points;
    Material *material;
```



```

    ...
    FPtr_draw func_draw;
};

static void i_draw_conceptual(const Shape *shape, DCtx *ctx)
{
    /* Do simple drawing */
}

static void i_draw_realistic(const Shape *shape, DCtx *ctx)
{
    /* Do complex drawing */
}

Shape *shape[N];
Shape *shape[0] = heap_new(Shape);
Shape *shape[1] = heap_new(Shape);
shape[0]->func_draw = i_draw_conceptual;
shape[1]->func_draw = i_draw_realistic;
...

for (i = 0; i < N; ++i)
    shape[i]->func_draw(shape[i], ctx);

```

4.8. Preprocessor

Our standards make heavy use of the preprocessor, especially for type checking at compile time. This helps to detect errors in the code before running the program (static analysis), as opposed to the C++ RTTI that does it once it is running (dynamic analysis).

Using the preprocessor to check types.

```

#define arrst_destroy(array, func_remove, type)\
    ((void)((array) == (ArrSt(type)**)(array)),\
    FUNC_CHECK_REMOVE(func_remove, type),\
    array_destroy_imp((Array**) (array), (FPtr_remove)func_remove, (const char_t\
    ↪ *) (ARRST#type)))

ArrSt(Product) *products = arrst_create(Product);
...
static void i_remove_product(Product *product)
{
}
...

/* 'products' and 'i_remove_product' will be checked at compile time */
arrst_destroy(&products, i_remove_product, Product);

```

*Dynamic typing is not necessarily good. You get static errors at runtime, which really should be catchable at compile time. **Rob Pike.***

4.9. Comments

In general, the use of comments will be reduced as much as possible. A comment will be placed at the beginning of each file as a general description. We also use a comment line as a separator when implementing functions.

```

stream.c
/* Data streams. Manage connection-oriented communication */

#include "stream.h"
#include "stream.inl"
#include "bfile.h"
#include "bmem.h"
...

/*-----*/

static void i_func1(void)
{
    /* Do something */
}

/*-----*/

static void i_func2(void)
{
    /* Do something */
}

```

C++ comments `//Comment...` are NOT allowed, as they generate warnings in certain `gcc -std=gnu90` compilers.

Another aspect that is **totally prohibited** is the inclusion of documentation blocks within the source code, not even in the headers themselves. NAppGUI uses `ndoc` for documentation tasks, a utility that allows you to create html/pdf documents enriched with images, cross-references, examples, etc. and that uses its own files totally separated from the code. Another added advantage is the cleanliness of the `*.h` headers of all the modules, where it is very easy to locate what we are looking for.

Documentation blocks are NOT allowed.

```
/* Forbidden, non used */
```

```

/* Gets the area of the polygon.
   \param pol The polygon.
   \return The area.
*/
real32_t pol2d_areaf(const Pol2Dd *pol);

```

Header example in NAppGUI.

```

/* 2d convex polygon */

#include "geom2d.hxx"

__EXTERN_C

Pol2Df* pol2d_createf(const V2Df *points, const uint32_t n);

Pol2Df* pol2d_copyf(const Pol2Df *pol);

void pol2d_destroyf(Pol2Df **pol);

void pol2d_transformf(Pol2Df *pol, const T2Df *t2d);

const V2Df *pol2d_pointsf(const Pol2Df *pol);

uint32_t pol2d_nof(const Pol2Df *pol);

real32_t pol2d_areaf(const Pol2Df *pol);

bool_t pol2d_ccwf(const Pol2Df *pol);

bool_t pol2d_convexf(const Pol2Df *pol);

__END_C

```

All comments in NAppGUI are made in English language.

4.10. Input/Output

Input/output is not part of the C language as such. As the language spread in the mid-1970s, a number of useful routines were grouped together into what became the **Standard C Library**. NAppGUI encapsulates all its functionality in “Sewer” (page 156), “Osbs” (page 174) or “Core” (page 195) generally implementing it as much more direct and efficient calls to the operating system.

Use of safe I/O functions.

```

/* Do not use cstdlib in applications */
#include <stdio.h>

```

```
FILE *fp = fopen("/tmp/test.txt", "w+");
fprintf(fp, "This is testing for fprintf...\n");
fclose(fp);

/* Use NAppGUI functions */
#include "stream.h"
Stream *stm = stm_to_file("/tmp/test.txt", NULL);
stm_printf(stm, "This is testing for stm_printf...\n");
stm_close(&stm);
```

*Use of the **Standard C Library** is not recommended. Look for the equivalent function in **Sewer**, **Osbs**, or **Core**.*

4.11. Mathematical algorithms

NAppGUI uses *C++ templates* to implement any function or mathematical algorithm. With this it is possible to offer `float` and `double` versions in an elegant way and with easy maintenance. The templates are hidden and not exposed in the API, so that their use remains ANSI-C90 compliant. For more information “*Math templates*” (page 53).

NAppGUI makes internal use of C++98 `template<>` to implement everything related to mathematical calculation.

Use of C++

Web servers are written in C, and if they're not, they're written in Java or C++, which are C derivatives, or Python or Ruby, which are implemented in C.

Rob Pike

5.1	Use of C++	45
5.2	Encapsulation	46
5.3	Class callbacks	46
5.4	Combine C and C++ modules	48
5.4.1	Using C from C++	48
5.4.2	Using C++ from C	48
5.5	new and delete overload	49
5.6	Hello C++ complete	50
5.7	Math templates	53

5.1. Use of C++

Object-oriented programming (encapsulation, inheritance and polymorphism) is a very powerful tool for modeling certain kinds of problems. However, at NAppGUI we believe that it is wrong to impose a class hierarchy at the SDK level, as this is too low a level. The SDK is closer to the operating system and the machine than to the real-world problems solved by applications, where an object-oriented approach may (or may not) be more successful.

Although NAppGUI has been designed to create applications in “pure” C, it is possible to use C++ or mix both languages. We’ll give some advice, porting our “*Hello World!*” (page 23) application to C++ (Figure 5.1).

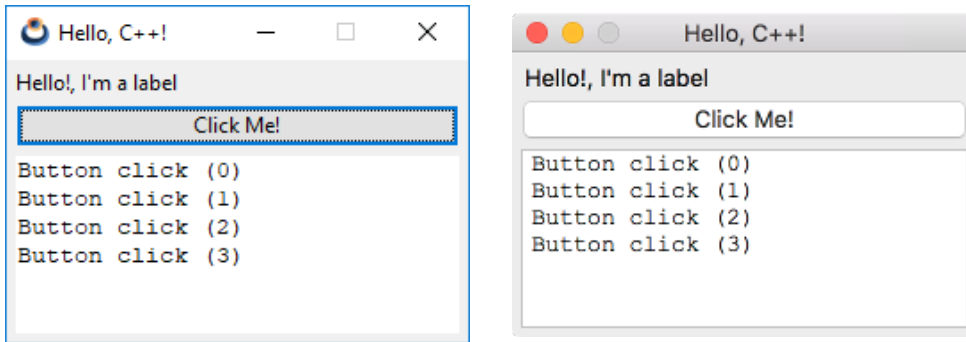

Figure 5.1: Migration from *Hello, world!* to C++.

5.2. Encapsulation

NAppGUI does not enforce any class hierarchy, leaving the programmer the freedom to encapsulate using their own classes. Of course, since C++ includes C, we can call any SDK C function inside a member function. For example, we can encapsulate the main window like this.

```
class MainWindow
{
public:
    MainWindow();
    ~MainWindow();

private:
    static void i_OnClose(MainWindow *window, Event *e);
    static void i_OnButton(MainWindow *window, Event *e);
    Panel *i_panel(void);

    Window *window;
    TextView *text;
    uint32_t clicks;
};
```

As you can see, relative to the C version, `i_panel` no longer needs parameters, as it uses the implicit `this` pointer to access class members.

5.3. Class callbacks

Event handlers are C functions whose first parameter is a pointer to the object that receives the message. This works the same way using static functions within a C++ class:

```
...
static void i_OnClose(MainWindow *window, Event *e);
```

```
...
window_OnClose(this->window, listener(this, i_OnClose, MainWindow));
...
```

However, we may want to use member functions as event handlers, using the **this** pointer as the receiver. To do this, we derive our `MainWindow` from the `IListener` interface and use the `listen` macro instead of `listener()` .

```
class MainWindow : public IListener
{
...
    void i_OnClose(Event *e);
    void i_OnButton(Event *e);
...
};

void MainWindow::i_OnButton(Event *e)
{
    String *msg = str_printf("Button click (%d)\n", this->clicks);
    ...
}
...
button_OnClick(button, listen(this, MainWindow, i_OnButton));
...
```

IListener is a C++ interface that allows you to use class member methods as event handlers.

It is also possible to direct the event to a different object (and of a different class) than the control owner. To do this, we indicate the receiver as the first parameter of `listen`, as we see below. The click of the close button will be processed in the `App` class and not in `MainWindow`.

```
class App : public IListener
{
public:
    App();
    ~App();
    void i_OnClose(Event *e);

private:
    MainWindow *main_window;
};

class MainWindow : public IListener
{
public:
    MainWindow(App *app);
```



```

}

MainWindow::MainWindow(App *app)
{
    ...
    window_OnClose(this->window, listen(app, App, i_OnClose));
    ...
}

void App::i_OnClose(Event *e)
{
    osapp_finish();
}

```

We can establish as event receiver, any object that implements the `IListener` interface.

5.4. Combine C and C++ modules

A C/C++ project selects the compiler based on the file extension. For `*.c` the C compiler will be used and for `*.cpp` the C++ compiler. The same project can combine modules in both languages if we consider the following.

5.4.1. Using C from C++

There is no problem if the C header function declarations are between the macros: `__EXTERN_C` and `__END_C`.

```

__EXTERN_C

real32_t mymaths_add(const real32_t a, const real32_t b);

real32_t mymaths_sub(const real32_t a, const real32_t b);

__END_C

```

`__EXTERN_C` and `__END_C` are aliases for `extern "C" {}`. This tells the C++ compiler not to use name mangling^a with C functions.

^ahttps://en.wikipedia.org/wiki/Name_mangling

5.4.2. Using C++ from C

C does not understand the `class` keyword and will give a compile error when including C++ headers. It is necessary to define an interface in C over C++ code.

mywindow.h

```

__EXTERN_C

typedef struct _mywin_t MyWindow;

MyWindow *mywindow_create();

void mywindow_move(MyWindow *window, const real32_t x, const real32_t y);

__END_C

```

mywindow.cpp

```

class MainWindow
{
public:
    MainWindow();
    void move(const real32_t x, const real32_t y);
};

MyWindow *mywindow_create()
{
    return (MyWindow*)new MainWindow();
}

void mywindow_move(MyWindow *window, const real32_t x, const real32_t y)
{
    ((MainWindow*)window)->move(x, y);
}

```

5.5. new and delete overload

C++ uses the new and delete operators to create dynamic instances of objects. We can make reservations through Heap, the “*Heap - Memory manager*” (page 196) manager that NAppGUI incorporates, in order to optimize C++ and control *Memory Leaks*.

```

class MainWindow : public IListener
{
    ...
    void *operator new(size_t size)
    {
        return (void*)heap_malloc((uint32_t)size, "MainWindow");
    }

    void operator delete(void *ptr, size_t size)
    {
        heap_free((byte_t**) &ptr, (uint32_t)size, "MainWindow");
    }
    ...
}

```

};

5.6. Hello C++ complete

Listing 5.1: demo/hellocpp/main.cpp

```

/* NAppGUI C++ Hello World */

#include <nappgui.h>

class App;

class MainWindow : public IListener
{
public:
    MainWindow(App *app);
    ~MainWindow();

    void *operator new(size_t size) { return (void*)heap_malloc((uint32_t)size,
        ↪ "MainWindow"); }
    void operator delete(void *ptr, size_t size) { heap_free((byte_t**) &ptr, (
        ↪ uint32_t)size, "MainWindow"); }

private:
    void i_OnButton(Event *e);
    Panel *i_panel(void);

    Window *window;
    TextView *text;
    uint32_t clicks;
};

/*-----*/

class App : public IListener
{
public:
    App();
    ~App();
    void i_OnClose(Event *e);
    void *operator new(size_t size) { return (void*)heap_malloc((uint32_t)size,
        ↪ "App"); }
    void operator delete(void *ptr, size_t size) { heap_free((byte_t**) &ptr, (
        ↪ uint32_t)size, "App"); }

private:
    MainWindow *main_window;
};

/*-----*/

```

```

void MainWindow::i_OnButton(Event *e)
{
    String *msg = str_printf("Button click (%d)\n", this->clicks);
    textview_writeln(this->text, tc(msg));
    str_destroy(&msg);
    this->clicks += 1;
    unref(e);
}

/*-----*/

Panel *MainWindow::i_panel(void)
{
    Panel *panel = panel_create();
    Layout *layout = layout_create(1, 3);
    Label *label = label_create();
    Button *button = button_push();
    TextView *textv = textview_create();
    this->text = textv;
    label_text(label, "Hello!, I'm a label");
    button_text(button, "Click Me!");
    button_OnClick(button, IListen(this, MainWindow, i_OnButton));
    layout_label(layout, label, 0, 0);
    layout_button(layout, button, 0, 1);
    layout_textview(layout, textv, 0, 2);
    layout_hsize(layout, 0, 250);
    layout_vsize(layout, 2, 100);
    layout_margin(layout, 5);
    layout_vmargin(layout, 0, 5);
    layout_vmargin(layout, 1, 5);
    panel_layout(panel, layout);
    return panel;
}

/*-----*/

void App::i_OnClose(Event *e)
{
    osapp_finish();
    unref(e);
}

/*-----*/

MainWindow::MainWindow(App *app)
{
    Panel *panel = i_panel();
    this->window = window_create(EKWINDOW_STD);
    this->clicks = 0;
    window_panel(this->window, panel);
}

```

```

    window_title(this->window, "Hello, C++!");
    window_origin(this->window, v2df(500, 200));
    window_OnClose(this->window, IListen(app, App, i_OnClose));
    window_show(this->window);
}

/*-----*/

MainWindow::~MainWindow()
{
    window_destroy(&this->window);
}

/*-----*/

App::App(void)
{
    this->main_window = new MainWindow(this);
}

/*-----*/

App::~App()
{
    delete this->main_window;
}

/*-----*/

static App *i_create(void)
{
    return new App();
}

/*-----*/

static void i_destroy(App **app)
{
    delete *app;
    *app = NULL;
}

/*-----*/

#include "osmain.h"
osmain(i_create, i_destroy, "", App)

```

5.7. Math templates

In NAppGUI there are two versions for all (Listing 5.2) functions and math types: `float` (`real32_t`) and `double` (`real64_t`). We can use one or the other as appropriate in each case.

Listing 5.2: Cabecera `bmath.h` (parcial).

```

/* Math functions */

#include "osbs.hxx"

__EXTERN_C

real32_t bmath_cosf(const real32_t angle);

real64_t bmath_cosd(const real64_t angle);

real32_t bmath_sinf(const real32_t angle);

real64_t bmath_sind(const real64_t angle);

extern const real32_t kBMATH_PIf;
extern const real64_t kBMATH_PId;
extern const real32_t kBMATH_SQRT2f;
extern const real64_t kBMATH_SQRT2d;

__END_C

```

All single-precision functions and types end with the suffix “f” and double-precision types end with “d”.

When we implement more complex geometric or algebraic functions, it is not easy to be clear in advance what the correct precision is. When in doubt, we can always choose to use `double`, but this will have an impact on performance, especially due to the use of memory bandwidth. Consider the case of 3D meshes with thousands of vertices. It would be great to have both versions and be able to use one or the other according to each specific case.

Unfortunately the “pure” C language does not allow programming with generic types, apart from using horrible and endless macros. We will have to implement both versions (`float` and `double`), with the associated maintenance cost. C++ solves the problem thanks to templates (`template<>`). The downside is that, normally, we must “open” the implementation and include it in the `.h` header, since the compiler does not know how to generate the machine code until the template is instantiated with a specific data type. . This is in direct conflict with our “Standards” (page 58), especially in the part related to information encapsulation. Next we will see how to use C++ templates to get the best of both cases: Generic programming, hiding implementations and keeping headers “clean”.

Just as there is a *.h header for every math module, there is a counterpart *.hpp usable only from C++ (Listing 5.3) modules.

Listing 5.3: Header bmath.hpp (partial).

```

/* Math functions */

#include "osbs.hxx"

template<typename real>
struct BMath
{
    static real(*cos)(const real angle);

    static real(*sin)(const real angle);

    static const real kPI;
    static const real kSQRT2;
};

```

These templates contain pointers to functions, whose implementations are hidden in bmath.cpp. In (Listing 5.4) we have an example of use.

Listing 5.4: Implementation of a generic algorithm.

```

#include "bmath.hpp"

template<typename real>
static void i_circle(const real r, const uint32_t n, V2D<real> *v)
{
    real a = 0, s = (2 * BMath<real>::kPI) / (real)n;
    for (uint32_t i = 0; i < n; ++i, a += s)
    {
        v[i].x = r * BMath<real>::cos(a);
        v[i].y = r * BMath<real>::sin(a);
    }
}

```

This algorithm is implemented within a C++ module (Listing 5.5), but we want to be able to call it from other modules, both C and C++. To do this we will define the two types of headers: *.h (Listing 5.6) and *.hpp (Listing 5.7).

Listing 5.5: mymath.cpp. Implementation.

```

#include "mymath.h"
#include "mymath.hpp"
#include "bmath.hpp"

template<typename real>
static void i_circle(const real r, const uint32_t n, V2D<real> *v)
{

```

```

    real a = 0, s = (2 * BMath<real>::kPI) / (real)n;
    for (uint32_t i = 0; i < n; ++i, a += s)
    {
        v[i].x = r * BMath<real>::cos(a);
        v[i].y = r * BMath<real>::sin(a);
    }
}

void mymath_circlef(const real32_t r, const uint32_t n, V2Df *v)
{
    i_circle<real32_t>(r, n, (V2D<real32_t>*)v);
}

void mymath_circled(const real64_t r, const uint64_t n, V2Dd *v)
{
    i_circle<real64_t>(r, n, (V2D<real64_t>*)v);
}

template<>
void(*MyMath<real32_t>::circle)(const real32_t, const uint32_t, V2D<real32_t>*)
    ↪ = i_circle<real32_t>;

template<>
void(*MyMath<real64_t>::circle)(const real64_t, const uint32_t, V2D<real64_t>*)
    ↪ = i_circle<real64_t>;

```

Listing 5.6: mymath.h. Cabecera C.

```

#include "geom2d.hxx"

__EXTERN_C

void mymath_circlef(const real32_t r, const uint32_t n, V2Df *v);
void mymath_circled(const real64_t r, const uint64_t n, V2Dd *v);

__END_C

```

Listing 5.7: mymath.hpp. Cabecera C++.

```

#include "v2d.hpp"

template<typename real>
struct MyMath
{
    void (*circle)(const real r, const uint32_t n, V2D<real> *v);
};

```

Now we can use our math library in C and C++, both in float and double precision (Listing 5.8).

Listing 5.8: Using mymaths in generic C++ algorithms.

```
#include "mymath.hpp"
#include "t2d.hpp"

template<typename real>
static void i_ellipse(const real r1, const real r2, const uint32_t n, V2D<real>
    ↪ *v)
{
    T2D<real> transform;
    T2D<real>::scale(&transform, r1, r2);

    MyMath<real>::circle(1, n, v);

    for (uint32_t i = 0; i < n; ++i)
        T2D<real>::vmult(&transform, &v[i]);
}
```

Error management

There is always one more bug to fix.

Ellen Ullman

6.1	Error management	57
6.2	Exhaustive tests	57
6.3	Static analysis	58
6.3.1	Standards	58
6.3.2	Compiler warnings	60
6.4	Dynamic analysis	61
6.4.1	Disabling Asserts	63
6.4.2	Debugging the program	63
6.4.3	Error log	63
6.4.4	Memory auditor	64

6.1. Error management

Developing software of a certain size and complexity can become a hellish task, if we do not adopt concrete measures to prevent and quickly locate programming *bugs*. Next we will talk about some strategies that we have used in the development of NAppGUI and that you can apply in your own projects.

6.2. Exhaustive tests

Ensuring that our software is bug free is as “easy” as running a test for each and every case the (Figure 6.1) program will face.

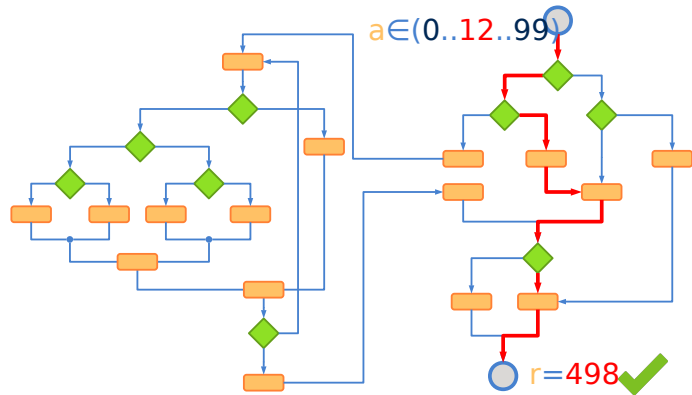

Figure 6.1: Exhaustive tests use all possible combinations of the input data.

Already from trivial theoretical examples, we see that we are dealing with an exponential problem (Figure 6.2), which will overwhelm the resources of any system with relatively few input variables. Therefore, we can intuit that it will be **impossible** to guarantee that our software is free of errors since it will not be feasible to reproduce all its use cases. However, we can define a strategy that helps us minimize the impact that these will have on the final product, detecting and correcting them as soon as possible.

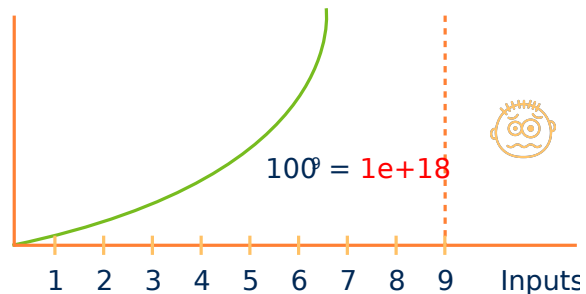

Figure 6.2: With only 9 input variables (in range 0..99) the computational resources will overflow.

6.3. Static analysis

Static analysis is the one that is carried out **before executing the program** and consists of two parts: The use of **standards** where rules and quality controls are applied during the writing of the code itself. And the **compiler warnings** that will help us locate potential compile-time errors.

6.3.1. Standards

The use of standards, understood as rules that we follow when programming, is essential when it comes to maintaining minimum levels of quality in our (Figure 6.3) projects. If they are not applied, a program of a certain size will become anarchic, unreadable, difficult to maintain and difficult to understand. In this scenario it will be easy to add new bugs

as we manipulate the source code.



Figure 6.3: Using standards will reduce the probability of bugs.

In reality, it is difficult to differentiate between good and bad standards, since they will depend on the type of project, programming languages, company philosophy and objectives to prioritize. We can see them as a *Style Guide* that evolves over time hand in hand with experience. What is truly important is to become aware of their usefulness, define and apply them. For example, if we decide to name variables with descriptive identifiers in English and an underscore (`product_code`), all our code should follow this rule without exception. Let's take a look at some of the standards we apply within NAppGUI. They are not the best nor do they have to adapt to all cases. They are only ours:

- Use a small subset of the language, as we've seen in “*Use of C*” (page 31). For example, expressions of the type `*((int*)block + i++) = i+1`, are totally prohibited. They are perfectly valid in C but poorly readable and confusing. Some programmers think that cryptic and compact code is much more maintainable, but we think they are wrong.
- Comments are prohibited, except on rare occasions and very justified. If something needs a comment, rewrite it. A comment that even slightly contradicts the code it is intended to clarify causes more confusion than help. And it is very easy for them to become obsolete.
- Reduced and clean public interfaces. Header files (`*.h`) represent a high level of abstraction as they reduce the connections between software components (Figure 6.4). They allow condensing, as an index, hundreds or thousands of lines of code in just fifteen or twenty public functions. It is completely forbidden to include type definitions (they will go in the `*.hxx`), comments (of course) and documentation blocks in `.h` files.
- Opaque objects. Object definitions (`struct _object_t`) will be made inside the implementation files (`*.c`) and never in the `*.h`. The objects will be manipulated

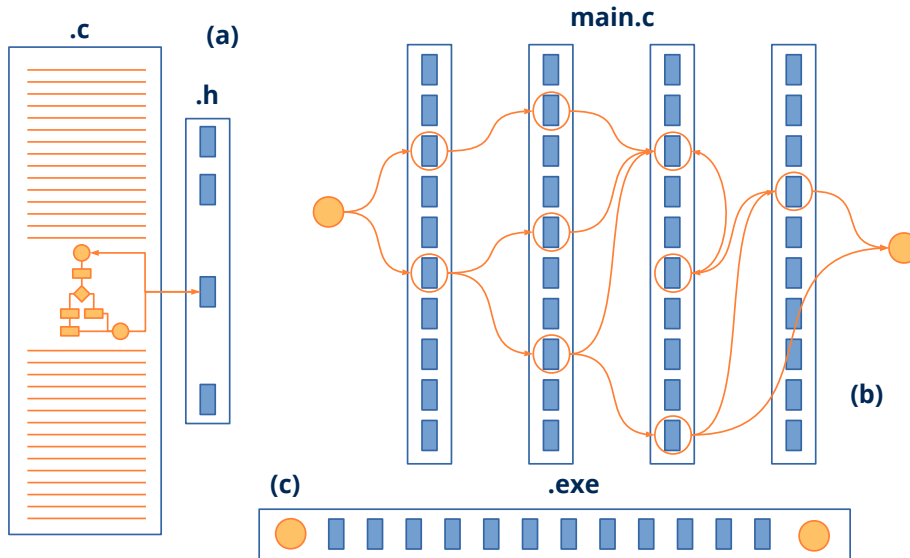

Figure 6.4: The *.h headers provide a high level of abstraction hiding the complexity of the (a) solution. They facilitate horizontal, problem-based development, as opposed to vertical learning based on (b) APIs. They help the linker reduce the size of the (c) executable.

with public functions that accept pointers to them, always hiding the fields that compose them. This point, together with the previous one on interfaces, perfectly defines the barriers between modules, clearly marking when one problem ends and another begins.

The first two rules help reduce the internal complexity of a module by making it as readable and less cryptic as possible. We could enrich them with others about indentation, style, variable naming, etc. We more or less strictly follow the advice of the great book *The Practice of Programming* (Figure 6.5).

6.3.2. Compiler warnings

The compiler is our great ally when it comes to examining the code for possible (Figure 6.6) errors. Enabling the highest possible level of *warnings* is essential to reduce errors caused by type conversions, uninitialized variables, unreachable code, etc. All projects built with NAppGUI will trigger the highest level of warnings possible, equivalent to `-Wall -Wpedantic` on all (Figure 6.7) platforms.

Figure 6.5: *The Practice of Programming* by Brian W. Kernighan and Rob Pike is a good source of inspiration for defining your own programming style.

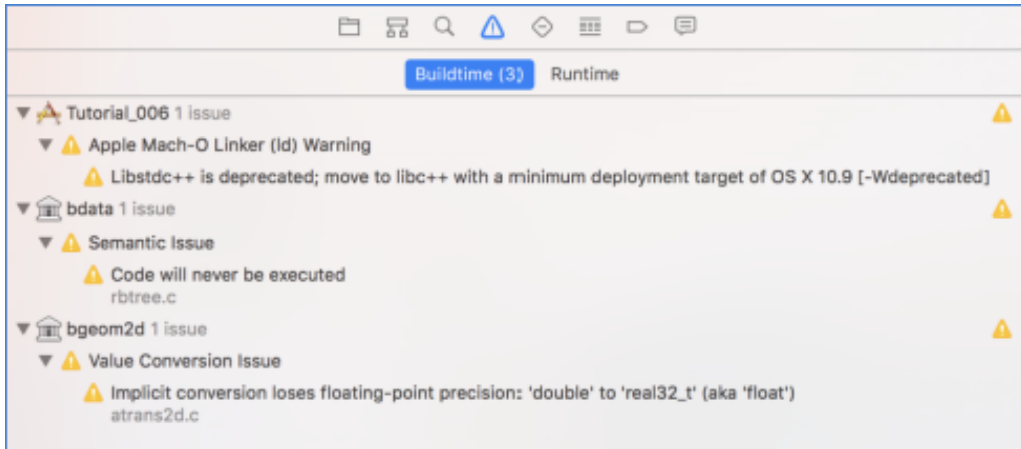
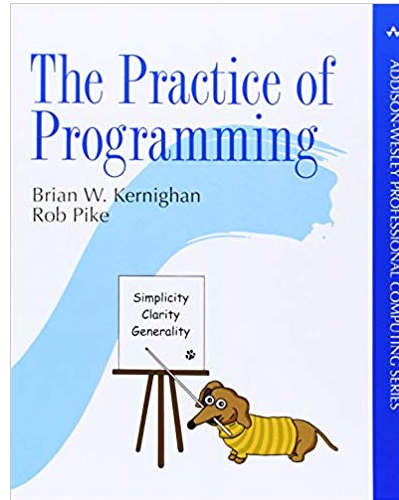

Figure 6.6: Fixing all compiler *warnings* should be a priority.

6.4. Dynamic analysis

Dynamic analysis is performed once the program is running. Here our main weapon is self-validations, implemented as “*Asserts*” (page 159) statements. Asserts are checks distributed throughout the source code, which are evaluated at runtime each time the program goes through them. If a statement resolves to `FALSE`, processing will stop and an (Figure 6.8) informational window will be displayed.

```
void layout_set_row_margin(Layout *layout, const uint32_t row, const real32_t
    ↪ margin)
{
    cassert_no_null(layout);
    cassert_msg(row < layout->num_rows, "'row' out of range");
}
```

Apple LLVM 9.0 - Warning Policies	
Setting	ALL_BUILD
Inhibit All Warnings	No ↕
Pedantic Warnings	Yes ↕
Treat Warnings as Errors	No ↕
Apple LLVM 9.0 - Warnings - All languages	
Setting	ALL_BUILD
Block Capture of Autoreleasing	Yes ↕
Check Switch Statements	Yes ↕
Deprecated Functions	Yes ↕
Documentation Comments	No ↕
Empty Loop Bodies	Yes ↕
Four Character Literals	Yes ↕
Hidden Local Variables	Yes ↕
Implicit Boolean Conversions	Yes ↕
Implicit Constant Conversions	Yes ↕
Implicit Conversion to 32 Bit Type	Yes ↕
Implicit Enum Conversions	Yes ↕
Implicit Float Conversions	Yes ↕
Implicit Integer to Pointer Conversions	Yes ↕
Implicit Non-Literal Null Conversions	Yes ↕
Implicit Signedness Conversions	Yes ↕
Infinite Recursion	Yes ↕
Initializer Not Fully Bracketed	Yes ↕
Mismatched Return Type	Yes ↕
Missing Braces and Parentheses	Yes ↕
Missing Fields in Structure Initializers	Yes ↕
Missing Function Prototypes	Yes ↕
Missing Newline At End Of File	No ↕
Out-of-Range Enum Assignments	Yes ↕
Pointer Sign Comparison	Yes ↕
Sign Comparison	Yes ↕

Figure 6.7: NAppGUI enables the highest level of *warnings* possible.

```

...
}

```

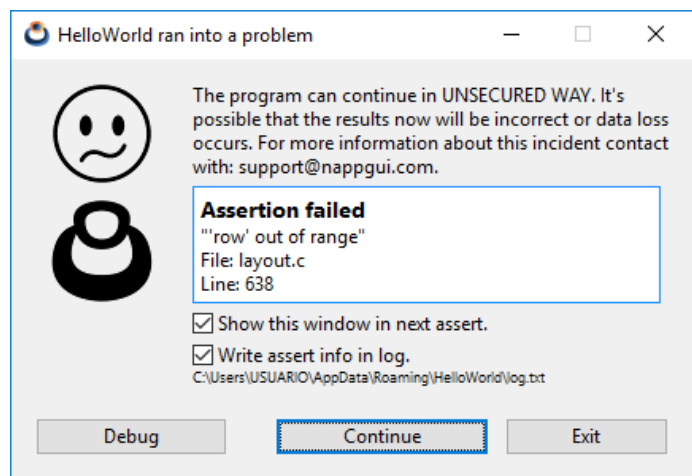

Figure 6.8: Window displayed after activating an assert.

*It is also possible to redirect **assert** statements to standard output or to the **Log** file.*

6.4.1. Disabling Asserts

Within the NAppGUI SDK code, more than 5000 assertions have been distributed, located at strategic points, which constantly evaluate the coherence and integrity of the software. Obviously, this number will grow after each revision, as more functionality is integrated. This turns the SDK into a real minefield, where any error in the use of the API functions will be automatically notified to the programmer. Depending on the configuration we are using, the assertions will be activated or deactivated:

- Debug: *Assert* statements are enabled.
- Release: The sentences *assert* are disabled.
- ReleaseWithAssert: As the name suggests, turns on all Release optimizations, but leaves *assert* statements on.

6.4.2. Debugging the program

When an assert is activated, the program stops right at the check point, showing the assert confirmation window. If we press the [Debug] button, we will access the *call stack* (Figure 6.9), which is the current function call stack, from the `main()` itself to the current breakpoint “*Stack Segment*” (page 169). By browsing the stack we can check the values of variables and objects at any call level. This will help us identify the source of the error, as the cause may be a few levels below detection.

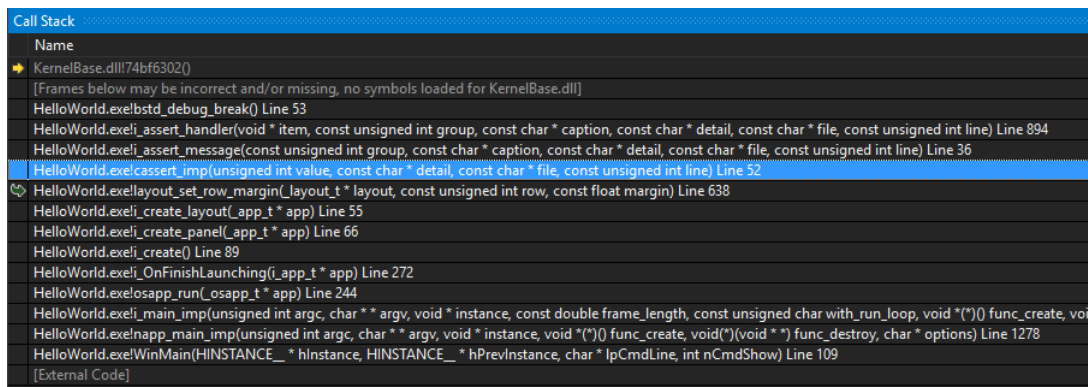

Figure 6.9: Call stack while debugging the assertion from the previous example.

6.4.3. Error log

An execution “*Log*” (page 192) is a file where the program dumps information about its status or anomalies detected. It can be very useful to know the cause of a failure when the software has already been distributed and it is not possible to debug it. NAppGUI

automatically creates a log file for each application located in the application data directory `APP_DATA\APP_NAME\log.txt`, for example `C:\Users\USER\AppData\Roaming\HelloWorld\log.txt`.

```
[15:42:29] Starting log for 'HelloWorld'
[15:42:29] TextView created: [0x6FFC7A30]
[15:42:32] Assertion failed (c:\\nappgui_1_0\\src\\gui\\layout.c:638): "'row'
↳ out of range"
[15:42:32] Assertion failed (c:\\nappgui_1_0\\src\\core\\array.c:512): "Array
↳ invalid index"
[15:42:34] You have an execution log in: 'C:\\Users\\USUARIO\\AppData\\Roaming
↳ \\HelloWorld\\log.txt'
```

As you can see, the assertions are automatically redirected to the *log* file. It is possible to disable this writing by unchecking the 'Write assert info in log' check in the info window. You can also add your own messages using the `log_printf` method.

```
log_printf("TextView created: [0x%X]", view);
```

6.4.4. Memory auditor

NAppGUI's memory manager "*Heap - Memory manager*" (page 196) has an associated auditor that checks for *leaks* memory after each execution of each application that uses the SDK. This is a great advantage over using external utilities, as dynamic memory checks are being performed **always** and not in isolated phases of development.

```
[18:57:33] [OK] Heap Memory Staticstics
[18:57:33] =====
[18:57:33] Total a/dellocations: 652962, 652962
[18:57:33] Total bytes a/dellocated: 18085221250, 18085221250
[18:57:33] Max bytes allocated: 238229150
[18:57:33] Effective reallocations: (0/1169761)
[18:57:33] Real allocations: 32776 pages of 65536 bytes
[18:57:33] 13271 pages greater than 65536 bytes
[18:57:33] =====
[18:57:33] Config: Debug
[18:57:33] You have an execution log in: 'C:\Users\USUARIO\AppData\Roaming\
↳ EuroPlane\log.txt'code.
```

Build NAppGUI

7.1	Build NAppGUI	65
7.2	Static linking	65
7.3	Dynamic linking	66
7.4	CMake Options	67
7.5	Build Options	68
7.6	Packaging and installation	69

7.1. Build NAppGUI

In “*Quick start*” (page 5) we already saw how to compile and run the examples from the source code. Now we will focus on installing the SDK in order to start creating our own applications. We will start within the previously downloaded project folder:

```
git clone --depth 1 https://github.com/frang75/nappgui_src.git
cd nappgui_src
```

7.2. Static linking

The following commands will generate the static link version of the libraries that make up NAppGUI.

```
// Windows
cmake -S . -B build -DNAPPGUI_DEMO=NO
cmake --build build --config Release -j 4
cmake --install build --config Release --prefix C:/nappgui

// macOS
```

```

cmake -G Xcode -S . -B build -DNAPPGUI_DEMO=NO
cmake --build build --config Release -j 4
cmake --install build --config Release --prefix /usr/local/nappgui

// Linux
cmake -S . -B build -DNAPPGUI_DEMO=NO -DCMAKE_BUILD_TYPE=Release
cmake --build build -j 4
cmake --install build --config Release --prefix /usr/local/nappgui

```

For CMake versions lower than **3.13**:

```

// Windows
mkdir build & cd build
cmake .. -DNAPPGUI_DEMO=NO -DCMAKE_INSTALL_PREFIX=C:/nappgui
cmake --build . --config Release
msbuild INSTALL.vcxproj /p:Configuration=Release

// macOS
mkdir build ; cd build
cmake .. -G Xcode -DNAPPGUI_DEMO=NO -DCMAKE_INSTALL_PREFIX=/usr/local/nappgui
cmake --build . --config Release
xcodebuild -target install -configuration Release

// Linux
mkdir build ; cd build
cmake .. -DNAPPGUI_DEMO=NO -DCMAKE_BUILD_TYPE=Release -DCMAKE_INSTALL_PREFIX=/
    ↪ usr/local/nappgui
cmake --build .
make install

```

7.3. Dynamic linking

If you prefer to generate NAppGUI in dynamic link mode (.dll, .so, .dylib), follow these instructions.

```

// Windows
cmake -S . -B build -DNAPPGUI_DEMO=NO -DNAPPGUI_SHARED=YES
cmake --build build --config Release -j 4
cmake --install build --config Release --prefix C:/nappgui

// macOS
cmake -G Xcode -S . -B build -DNAPPGUI_DEMO=NO -DNAPPGUI_SHARED=YES
cmake --build build --config Release -j 4
cmake --install build --config Release --prefix /usr/local/nappgui

// Linux
cmake -S . -B build -DNAPPGUI_DEMO=NO -DNAPPGUI_SHARED=YES -DCMAKE_BUILD_TYPE=
    ↪ Release
cmake --build build -j 4

```

```
cmake --install build --config Release --prefix /usr/local/nappgui
```

For CMake versions lower than **3.13**:

```
// Windows
mkdir build & cd build
cmake .. -DNAPPGUI_DEMO=NO -DNAPPGUI_SHARED=YES -DCMAKE_INSTALL_PREFIX=C:/
    ↪ nappgui
cmake --build . --config Release
msbuild INSTALL.vcxproj /p:Configuration=Release

// macOS
mkdir build ; cd build
cmake .. -G Xcode -DNAPPGUI_DEMO=NO -DNAPPGUI_SHARED=YES -DCMAKE_INSTALL_PREFIX
    ↪ =/usr/local/nappgui
cmake --build . --config Release
xcodebuild -target install -configuration Release

// Linux
mkdir build ; cd build
cmake .. -DNAPPGUI_DEMO=NO -DNAPPGUI_SHARED=YES -DCMAKE_BUILD_TYPE=Release -
    ↪ DCMAKE_INSTALL_PREFIX=/usr/local/nappgui
cmake --build .
make install
```

If you use NAppGUI in DLL mode you must ensure that your future applications find the libraries, updating the PATH variable of each system.

```
// Windows
set PATH=C:\nappgui\bin;%PATH%

// Linux
export LD_LIBRARY_PATH=/usr/local/nappgui/bin:$LD_LIBRARY_PATH$

// macOS
export DYLD_LIBRARY_PATH=/usr/local/nappgui/bin:$DYLD_LIBRARY_PATH$
```

7.4. CMake Options

We indicate below all the CMake options supported by NAppGUI. In “*Generators, compilers and IDEs*” (page 114) you will have more detailed information.

```
cmake -G [Generator] -S [SourceDir] -B [BuildDir] [Options]
```

- -G: “*CMake Generators*” (page 115). If omitted, the value of CMAKE_GENERATOR or a default will be used.
- -S: Directory where the NAppGUI file CMakeLists.txt is located.

- `-B`: Directory where the compilation projects and binaries will be generated.
- `-DNAPPGUI_DEMO=[YES|NO]`: Generate the example applications. By default YES.
- `-DNAPPGUI_SHARED=[YES|NO]`: Generates dynamic link libraries (`.dll`, `.so`, `.dylib`). By default NO.
- `-DNAPPGUI_WEB=[YES|NO]`: Add native support for the `WebView` control. By default YES. See “*Disable WebView*” (page 338).
- `-DCMAKE_BUILD_TYPE=[Debug|Release]`: In mono-configuration generators, eg. Unix Makefiles, configure the build mode. By default Debug.
- `-DCMAKE_C_COMPILER=[gcc|clang|cl]`: On Unix Makefiles, MinGW, MSYS or Ninja select the C compiler.
- `-DCMAKE_CXX_COMPILER=[g++|clang++|cl]`: On Unix Makefiles, MinGW, MSYS, or Ninja, select the C++ compiler.
- `-A=[Win32|x64]`: In Windows select the target architecture.
- `-DCMAKE_ARCHITECTURE=[x64|i386|arm|arm64]`: On Linux or macOS, select the target architecture. By default, that of the compilation machine. `arm` is not supported on macOS. `i386` is restricted on macOS. See “*macOS 32bits*” (page 130).
- `-DCMAKE_OSX_DEPLOYMENT_TARGET=12.4`: In macOS, minimum version of the operating system supported. By default, the most modern one included in the compiler. See “*Xcode*” (page 123).
- `-DCMAKE_TOOLKIT=GTK3`: In Linux it indicates the graphical toolkit used to render the interface elements. At the moment, only GTK3.
- `-CMAKE_DISABLE_CRTDBG=YES`: Disables the `crtDBG` library on Windows that controls memory leaks during execution. In principle, its use is not recommended, but it can be useful in projects that use third-party libraries with static or singleton objects.

7.5. Build Options

Once the scripts have been generated in the previous step, we launch the compilation using CMake.

```
cmake --build [BuildDir] --config [Debug|Release] -j [NumProcs]
```

- `--build`: Directory where the build projects are located (configuration parameter `-B`).

- `--config`: In multi-configuration generators, eg. Visual Studio indicates which configuration to compile (Debug or Release).
- `-j`: Number of concurrent compilation processes or threads.

After compilation we will have the executables and dynamic libraries in `[BuildDir]/[Debug|Release]/bin`. In `/lib` the static libraries.

7.6. Packaging and installation

After compilation, we package the binaries and headers in order to have them available when creating our own applications.

```
cmake --install [BuildDir] --config [Debug|Release] --prefix [PackagePath]
```

- `--install`: Directory where the binaries are located (configuration parameter `-B`).
- `--config`: Configuration to be packaged (Debug or Release).
- `--prefix`: Installation destination directory. If omitted, CMake will use the default system directories: `/usr/local` on UNIX or `C:/Program Files/{PROJECT_NAME}` on Windows.

*To install in system directories (without the `--prefix`), we may have to run **cmake --install** in administrator mode.*

In the destination path we will have this file and directory structure:

```
nappgui|—
bin|—
  nrc|—
inc|—
  core||—
    array.h||—
    arrpt.h||—
    ...|—
  draw2d||—
    color.h||—
    dctx.h||—
    ...|—
  geom2d||—
    box2d.h||—
    box2d.hpp||—
    ...|—
  gui||—
    button.h||—
    cell.h||—
    ...|—
  inet||—
```

```

    base64.h || ─
    httpreq.h || ─
    ... | ─
nappgui.h | ─
osapp | ─
    osapp.def || ─
    osapp.h || ─
    ... | ─
osbs | ─
    bfile.h || ─
    bmutex.h || ─
    ... | ─
osgui | ─
    osbutton.h || ─
    oscombo.h || ─
    ... | ─
sewer | ─
    arch.hxx || ─
    blib.h || ─
    ... | ─
lib | ─
    libcore.a | ─
    libdraw2d.a | ─
    libgeom2d.a | ─
    libgui.a | ─
    libinet.a | ─
    libosapp.a | ─
    libosbs.a | ─
    libosgui.a | ─
    libsewer.a ─
prj | ─
    CMakeTarget.cmake | ─
    ... | ─
    version.txt ─
cmake ─
    nappgui-config.cmake ─
    ...

```

In the /bin folder the DLLs will be installed, if we have chosen the dynamic link.

Library names are different on Windows (XXXX.lib) than on Linux/macOS (libXXXX.a).

Create new application

I consider myself a technical person who chose a great project and an excellent way to carry it out.

Linus Torvalds.

8.1	Create new application	71
8.2	Use of <code>find_package()</code>	71
8.3	<code>NAppProject.cmake</code>	73
8.4	Add files	75
8.5	Command line applications	76
8.6	Example projects	78
8.7	C/C++ standard	78

8.1. Create new application

In “*Build NAppGUI*” (page 65) we have seen how to compile and package the SDK. Also, in “*Hello World!*” (page 23), we learned the basic structure of a NAppGUI-based application. The time has come to create our own applications, taking advantage of the CMake modules included in the `/prj` folder of the installation.

This chapter is focused on the use of CMake. If you use another build system in your projects, you will have to adapt the dependency management yourself.

8.2. Use of `find_package()`

NAppGUI supports the CMake `find_package()` command, so managing dependencies is extremely simple. It also provides a series of modules within the installation’s `/prj`

directory, which simplify project creation. Create a new folder and add this single file `CMakeLists.txt`:

CMakeLists.txt

```
cmake_minimum_required(VERSION 3.0)
project(NAppHello)
find_package(nappgui REQUIRED)
include("${NAPPGUI_ROOT_PATH}/prj/NAppProject.cmake")
include("${NAPPGUI_ROOT_PATH}/prj/NAppCompilers.cmake")
nap_config_compiler()
nap_project_desktop_app(napphello hello)
```

We run CMake inside the new folder:

```
// Windows
cmake -S . -B build -DCMAKE_INSTALL_PREFIX=C:/nappgui
cmake --build build --config Debug

// macOS
cmake -G Xcode -S . -B build -DCMAKE_INSTALL_PREFIX=/usr/local/nappgui
cmake --build build --config Debug

// Linux
cmake -S . -B build -DCMAKE_BUILD_TYPE=Debug -DCMAKE_INSTALL_PREFIX=/usr/local/
  ↪ nappgui
cmake --build build
```

For CMake versions lower than **3.13**:

```
// Windows
mkdir build & cd build
cmake .. -DCMAKE_INSTALL_PREFIX=C:/nappgui
cmake --build . --config Debug

// macOS
mkdir build ; cd build
cmake .. -G Xcode -DCMAKE_INSTALL_PREFIX=/usr/local/nappgui
cmake --build . --config Debug

// Linux
mkdir build ; cd build
cmake .. -DCMAKE_BUILD_TYPE=Debug -DCMAKE_INSTALL_PREFIX=/usr/local/nappgui
cmake --build .
```

In the directory `/build/Debug/bin` you will have the `napphello` executable (Figure 8.1).

The `find_package()` command knows how to locate a package within the usual system directories, depending on each platform. We will need to specify the prefix only when the package is installed in any alternate directory.

Figure 8.1: Newly created application.

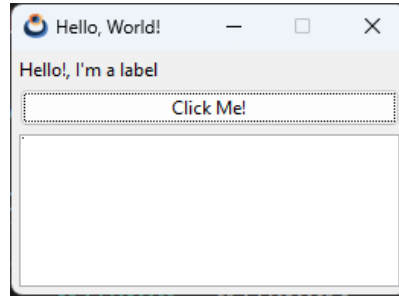

***-DCMAKE_INSTALL_PREFIX** does not imply priority in the search. `find_package()` might first find an installation in the system folders.*

8.3. NAppProject.cmake

The `nap_project_desktop_app()` function that we have used to create our application is located within the `NAppProject.cmake` module and will speed up certain aspects of the project (resources, dependencies, new files, etc). We open the Visual Studio solution that has been generated in `/build` (Figure 8.2).

Figure 8.2: Solution created by `NAppProject.cmake`.

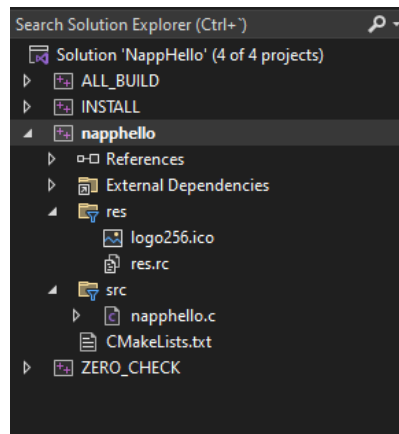

```
nap_project_desktop_app(appName path)
```

- `appName`: The name of the application.
- `path`: Subdirectory where the project will be located (in this case `hello`). Any route depth is supported. For example: `games/myapp`, `demo/games/myapp`, etc.

The first time this function is executed, several things are done:

- A new directory `hello` has been created with a default desktop application `napphello.c` and a `CMakeLists.txt`.
- A folder `hello/res` has been created with an image, and it has been used as the application icon. In “Resources” (page 99) we will continue to delve deeper into how to include images and texts in the application.
- The newly created `hello/CMakeLists.txt` has automatically linked to the NAppGUI binaries.

Successive calls to CMake will not overwrite the project files, so we can edit them without fear of losing the changes. Once the project is created, `nap_project_desktop_app()` will simply call `add_subdirectory()` to update changes. The `nap_desktop_app()` command in `hello/CMakeLists.txt` knows how to handle the quirks between different platforms. For example, in the case of macOS it will create a *bundle* instead of an isolated executable.

We don’t have to limit ourselves to a single application. Our solution will support different targets. For example add this line to `CMakeLists.txt` and rerun `cmake -S . -B build`.

CMakeLists.txt

```
cmake_minimum_required(VERSION 3.0)
project(NAppHello)
find_package(nappgui REQUIRED)
include("${NAPPGUI_ROOT_PATH}/prj/NAppProject.cmake")
include("${NAPPGUI_ROOT_PATH}/prj/NAppCompilers.cmake")
nap_config_compiler()
nap_project_desktop_app(napphello hello)

# New project
nap_project_desktop_app(nappbye bye)
```

If the solution was already open, it is possible that the IDE will notify you that there have been changes (Figure 8.3). After pressing [Reload], you will see that the new project (Figure 8.4) has appeared.

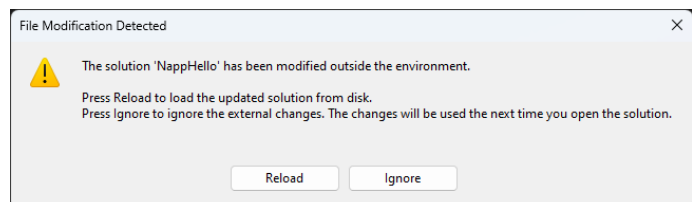

Figure 8.3: Notice of changes in Visual Studio.

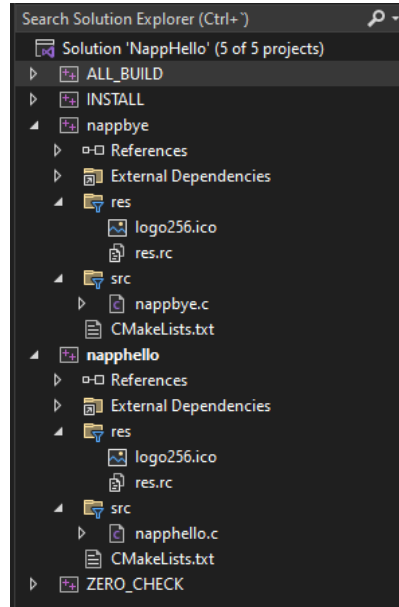

Figure 8.4: Solution update, with the new nappbye project.

8.4. Add files

Going back to the napphello project, we see that by default only one source code file (napphello.c) is created that contains the entire application. You will most likely want to split the code between different files. Create a pair of new files hello/myfunc.c and hello/myfunc.h from the IDE or directly from the browser. Open them and add these lines:

/hello/myfunc.h

```
// Example of new header
#include <core/core.hxx>

real32_t myadd_func(real32_t a, real32_t b);
```

/hello/myfunc.c

```
// Example of new c file
#include "myfunc.h"

real32_t myadd_func(real32_t a, real32_t b)
{
    return a + b;
}
```

Open /hello/napphello.c and edit the i_OnButton function.

/hello/napphello.c

```

...
static void i_OnButton(App *app, Event *e)
{
    real32_t res = myadd_func(56.4f, 23.3f);
    textview_printf(app->text, "Button click (%d-%.2f)\n", app->clicks, res);
    app->clicks += 1;
    unref(e);
}
...

```

Re-generate the solution with `cmake -S . -B build`. The IDE, Visual Studio in this case, informs us again that there have been changes in the `napphello` project. Simply press [Reload All] as we did in the previous case.

Recompile and run `napphello` to see the changes you just made. You can create as many files and subfolders within the `hello` directory as you need to better organize your code. Always remember to run `cmake -S . -B build` every time you add or remove files from the project. The `nap_desktop_app()` command will update the solution by “cloning” the directory structure within the project (`napphello` in this case).

At this point we recommend that you spend some time researching, compiling and testing the examples in the demo folder within the NAppGUI repository.

8.5. Command line applications

Similar to the desktop applications seen above, it is possible to create console applications. Add this new line to the `CMakeLists.txt` of the solution.

CMakeLists.txt

```

cmake_minimum_required(VERSION 3.0)
project(NAppHello)
find_package(nappgui REQUIRED)
include("${NAPPGUI_ROOT_PATH}/prj/NAppProject.cmake")
include("${NAPPGUI_ROOT_PATH}/prj/NAppCompilers.cmake")
nap_config_compiler()
nap_project_desktop_app(napphello hello)
nap_project_desktop_app(nappbye bye)

# New project
nap_project_command_app(myutil utils/myutil)

```

When regenerating the solution with `cmake -S . -B build`, Visual Studio will alert you again that you need to reload the solution. A new project will have been created

in `utils/myutil` (Figure 8.5), but this time if you compile and run it no window will appear. You will only see a message in the Visual Studio console:

```
Hello world!
```

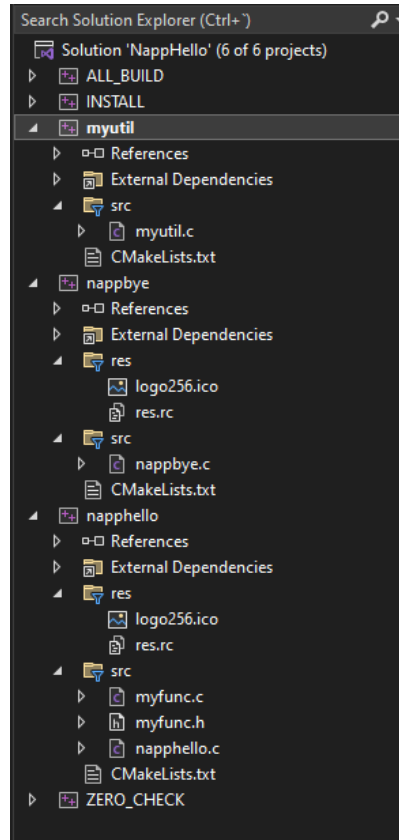

Figure 8.5: Solution with the three executables (targets).

If you open `myutil.c` you will find the code that generated the previous output:

```
/* NAppGUI Console Application */
#include <core/coreall.h>

int main(int argc, char *argv[])
{
    unref(argc);
    unref(argv);
    core_start();
    bstd_printf("Hello world!\n");
    core_finish();
    return 0;
}
```

Which is the typical template of a C program, to which the support of the *core* library has been included. From here, we can modify the code and compile. `nap_command_app()` already set everything up for us.

```
nap_project_command_app(appName path)
```

- `appName`: The name of the application.
- `path`: Relative path where the project will be located (in this case `utils/myutil`).

It goes without saying that the behavior of `nap_project_command_app()` is identical to that of `nap_project_desktop_app()`. It will not overwrite the project files once created and will integrate all new files that we add in the future.

8.6. Example projects

You have several packages at your disposal that you can use to test the installation of the SDK:

- `GuiHello`¹. Several examples of component usage: Buttons, Labels, Tables, etc.
- `Dice`². Example of the use of libraries.
- `Products`³. Example of HTTP requests in graphic applications.
- `WebHello`⁴. Example of a Web browser embedded in an application.
- `GLHello`⁵. Example of 3D graphics with OpenGL, embedded in an application.

8.7. C/C++ standard

Compilers generally allow you to check that code conforms to certain C/C++ standards, issuing warnings or errors when it does not. For the sake of portability, all projects generated by `nap_desktop_app()` and `nap_command_app()` set the older standards (C90 and C++98 respectively). You may want to use more modern standards in your projects. Open `hello/CMakeLists.txt` and add these two lines:

```
hello/CMakeLists.txt
```

```
nap_desktop_app(napphello "" NRC_NONE)
#-----
nap_target_c_standard(napphello 11)
```

¹<https://www.nappgui.com/examples/guihello.zip>

²<https://www.nappgui.com/examples/dice.zip>

³<https://www.nappgui.com/examples/products.zip>

⁴<https://www.nappgui.com/examples/webhello.zip>

⁵<https://www.nappgui.com/examples/glhello.zip>

```
nap_target_cxx_standard(napphello 14)
#-----
target_link_libraries(napphello ${NAPPGUI_LIBRARIES})
```

The `nap_target_c_standard()` command has set the C11 standard for `napphello`. Likewise, `nap_target_cxx_standard()` has selected C++14.

- C standard: 90, 99, 11, 17 y 23.
- C++ standard: 98, 11, 14, 17, 20, 23 y 26.

If CMake or the compiler does not support the indicated standard, the most modern allowed will be established. It is the responsibility of the programmer to use the appropriate compilers for the chosen standard.

Create new library

The only thing that you absolutely have to know, is the location of the library.

Albert Einstein

9.1	Create new library	81
9.2	Static libraries	81
9.3	Dynamic libraries	85
9.3.1	Advantages of DLLs	86
9.3.2	Disadvantages of DLLs	87
9.3.3	Check links with DLLs	88
9.3.4	Loading DLLs at runtime	91
9.3.5	Location of DLLs	93
9.4	Symbols and visibility	95
9.4.1	Export in DLLs	96
9.4.2	Checking in DLLs	97

9.1. Create new library

The use of libraries will allow us to share common code between several projects. An example is the NAppGUI SDK, which has been organized into several static or dynamic link libraries that can be reused by different applications.

9.2. Static libraries

We are going to rescue two applications included in the NAppGUI examples: `Die` (Figure 9.1) and `Dice` (Figure 9.2). In both you must be able to draw the silhouette of a

dice.

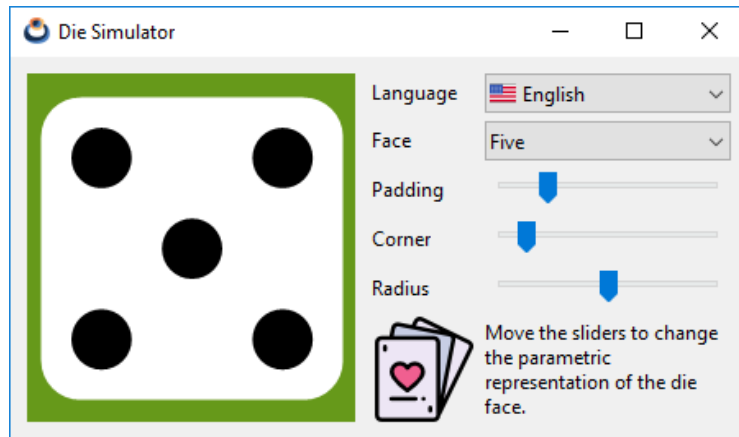

Figure 9.1: *Die* application.

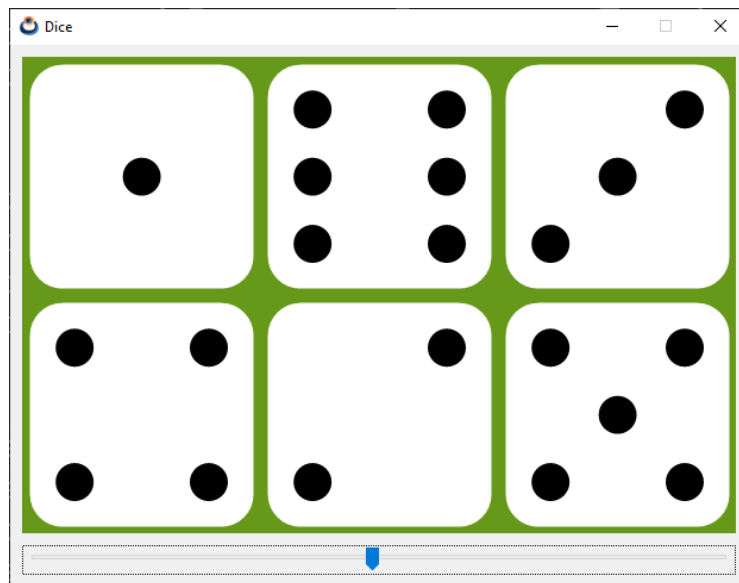

Figure 9.2: *Dice* application.

It is not very complicated to intuit that we could reuse the parametric drawing routine in both projects. One way to do this would be to copy said routine from *Die* to *Dice*, but this is not the most advisable since we would have two versions of the same code to maintain. Another option, the smartest, is to move the drawing function to a library and link it in both applications.

Download the complete example from this link¹. The structure of the project is very similar to what was seen in the previous chapter, starting with the main `CMakeLists.txt`:

`CMakeLists.txt`

```
cmake_minimum_required(VERSION 3.0)
project(Dice)
find_package(nappgui REQUIRED)
include("${NAPPGUI_ROOT_PATH}/prj/NAppProject.cmake")
include("${NAPPGUI_ROOT_PATH}/prj/NAppCompilers.cmake")
nap_config_compiler()
nap_project_library(casino casino)
nap_project_desktop_app(Die die)
nap_project_desktop_app(Dice dice)
```

- Line 1: Set the minimum version of CMake.
- Line 2: Project name.
- Line 3: Locate the NAppGUI-SDK installation.
- Line 4: Includes the `NAppProject.cmake` module.
- Line 5: Includes the `NAppCompilers.cmake` module.
- Line 6: Configure the compiler.
- Line 7: Create a target library in the `casino` directory.
- Line 8: Create a target application in the `die` directory.
- Line 9: Create a target application in the directory `dice`.

Notice that the `nap_project_library()` command precedes applications. This is because CMake needs to process dependencies before the projects that use them.

```
nap_project_library(libName path)
```

- `libName`: Name of the library.
- `path`: Relative path where the project is located.

As with application projects, the first time you run `nap_project_library()`, a series of default files are created. Later they can be edited, deleted or added more as we have just seen in the case of applications.

In `die/CMakeLists.txt` and `dice/CMakeLists.txt` we see the link with `casino`:

`die/CMakeLists.txt`

```
nap_desktop_app(Die "casino" NRC_EMBEDDED)
```

¹<https://www.nappgui.com/examples/dice.zip>

dice/CMakeLists.txt

```
nap_desktop_app(Dice "casino" NRC_NONE)
```

For now, don't worry about the constants `NRC_EMBEDDED` and `NRC_NONE`. In “*Resource processing*” (page 107) we will see them in detail. You can build and compile the project in the usual way:

```
// Windows
cmake -S . -B build -DCMAKE_INSTALL_PREFIX=C:/nappgui
cmake --build build --config Debug

// macOS
cmake -G Xcode -S . -B build -DCMAKE_INSTALL_PREFIX=/usr/local/nappgui
cmake --build build --config Debug

// Linux
cmake -S . -B build -DCMAKE_BUILD_TYPE=Debug -DCMAKE_INSTALL_PREFIX=/usr/local/
  ↪ nappgui
cmake --build build
```

In `build/Debug/bin` you will have the executables. Both *Die* and *Dice* have added a dependency on *casino* (Figure 9.3) via the `dependList` parameter from the `nap_desktop_app()` command. This way CMake knows that it must link, in addition to `NAppGUI-SDK` (`NAPPGUI_LIBRARIES`), the *casino* library, which is where common code from both projects is found (Figure 9.4).

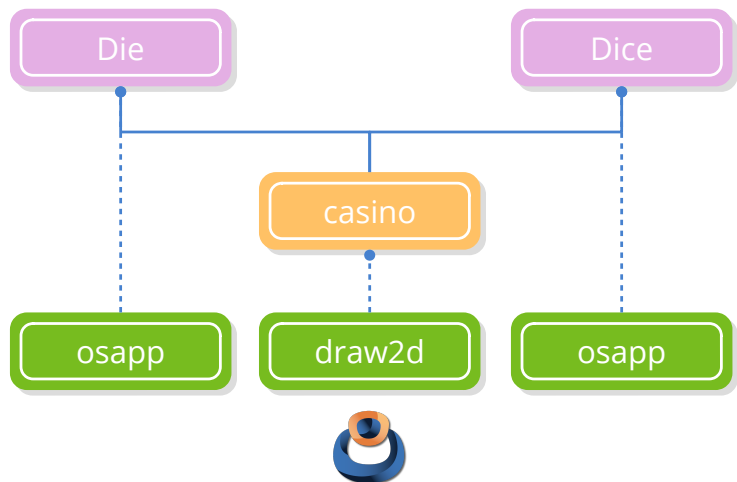

Figure 9.3: Application dependency tree, centered on the *casino* library.

What does it really mean that *Die* and *Dice* have a dependency on *casino*? From now on, none of them will be able to compile if there is an error in the *casino* code, since it is a fundamental module for both. Within the build project (Visual Studio, Xcode, Makefile, Ninja, etc.) several things have happened:

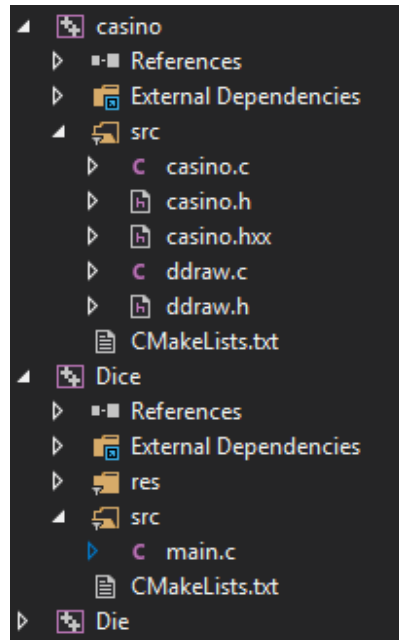

Figure 9.4: NAppDice solution with the three projects.

- Both applications know where *casino* is located, so they can do `#include "casino.h"` without worrying about its location.
- The binary code for the *casino* functions will be included in each executable in the linking process. CMake already took care of linking the library with the executables.
- Any changes made to *casino* will force the applications to be recompiled due to the previous point. Again, the build project will know how to do this as efficiently as possible. We will only have to re-launch `cmake --build build` to update all the binaries.

9.3. Dynamic libraries

Dynamic libraries are, in essence, the same as static ones. The only thing that changes is the way they link to the executable (Figure 9.5). In static linking, the library code is added to the executable itself, so its size will grow. In dynamic linking, the library code is distributed in its own file (`.dll`, `.so`, `.dylib`) and is loaded directly before the executable program.

To create the dynamic version of *casino*, open `casino/CMakeLists.txt` and change the `buildShared` parameter of `nap_library()` from `NO` to `YES`.

```

/casino/CMakeLists.txt
nap_library(casino "" YES NRC_NONE)

```

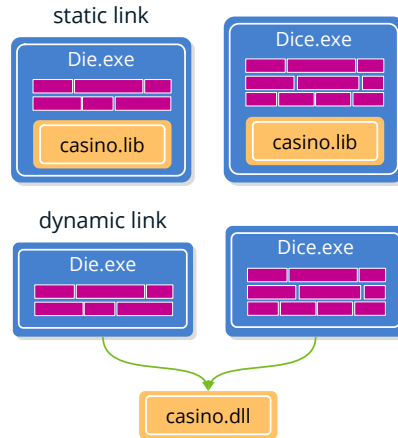

Figure 9.5: Static or dynamic *casino* link.

```
target_include_directories(casino PUBLIC "${NAPPGUI_INCLUDE_PATH}")
```

After re-generating and re-compiling the solution, you will notice that a new `casino.dll` appears in `build/Debug/bin`. This `dll` will be shared by `Die.exe` and `Dice.exe`, something that did not happen when compiling the static version.

/build/bin/Debug				
12/18/23	04:38 PM	<DIR>	.	
12/18/23	03:59 PM	<DIR>	..	
12/18/23	04:38 PM		53,248	casino.dll
12/18/23	04:38 PM		92,672	Dice.exe
12/18/23	04:38 PM		102,400	Die.exe

9.3.1. Advantages of DLLs

As we have been able to intuit in the previous example, using DLLs we will reduce the size of the executables, grouping the common binary code (Figure 9.6), (Figure 9.7). This is precisely what operating systems do. For example, `Die.exe` will ultimately need to access Windows API functions. If all applications had to statically link Windows binaries, their size would grow disproportionately and a lot of space would be wasted within the file system.

Another great advantage of DLLs is the saving of memory at runtime. For example, if we load `Die.exe`, `casino.dll` will be loaded at the same time. But if we then load `Dice.exe`, both will share the copy of `casino.dll` existing in memory. However, with static linking, there would be two copies of `casino.lib` in RAM: One embedded in `Die.exe` and another in `Dice.exe`.

Figure 9.6: The programming examples occupy **6.52 Mb** in their static version.

Name	Date modified	Type	Size
res	09-Dec-22 19:33	File folder	
Bode.exe	09-Dec-22 18:58	Application	467 KB
Bricks.exe	09-Dec-22 18:58	Application	394 KB
Col2dHello.exe	09-Dec-22 18:58	Application	512 KB
Dice.exe	09-Dec-22 18:58	Application	394 KB
Die.exe	09-Dec-22 18:58	Application	402 KB
DrawBig.exe	09-Dec-22 18:58	Application	425 KB
DrawHello.exe	09-Dec-22 18:58	Application	463 KB
DrawImg.exe	09-Dec-22 18:58	Application	748 KB
Fractals.exe	09-Dec-22 18:58	Application	397 KB
GuiHello.exe	09-Dec-22 18:58	Application	783 KB
HelloCpp.exe	09-Dec-22 18:58	Application	401 KB
HelloWorld.exe	09-Dec-22 18:58	Application	388 KB
Products.exe	09-Dec-22 18:58	Application	494 KB
Urllmg.exe	09-Dec-22 18:58	Application	419 KB

Figure 9.7: The programming examples occupy **4.08 Mb** in their dynamic version.

Name	Date modified	Type	Size
res	09-Dec-22 19:34	File folder	
Bode.exe	09-Dec-22 19:19	Application	151 KB
Bricks.exe	09-Dec-22 19:19	Application	124 KB
Col2dHello.exe	09-Dec-22 19:19	Application	147 KB
Dice.exe	09-Dec-22 19:19	Application	122 KB
Die.exe	09-Dec-22 19:19	Application	129 KB
DrawBig.exe	09-Dec-22 19:19	Application	126 KB
DrawHello.exe	09-Dec-22 19:19	Application	184 KB
DrawImg.exe	09-Dec-22 19:19	Application	452 KB
Fractals.exe	09-Dec-22 19:19	Application	125 KB
GuiHello.exe	09-Dec-22 19:19	Application	473 KB
HelloCpp.exe	09-Dec-22 19:19	Application	135 KB
HelloWorld.exe	09-Dec-22 19:19	Application	121 KB
Products.exe	09-Dec-22 19:19	Application	149 KB
Urllmg.exe	09-Dec-22 19:19	Application	125 KB
casino.dll	09-Dec-22 19:19	Application exten...	91 KB
core.dll	09-Dec-22 19:19	Application exten...	187 KB
draw2d.dll	09-Dec-22 19:19	Application exten...	156 KB
geom2d.dll	09-Dec-22 19:19	Application exten...	291 KB
gui.dll	09-Dec-22 19:19	Application exten...	194 KB
inet.dll	09-Dec-22 19:19	Application exten...	113 KB
osapp.dll	09-Dec-22 19:19	Application exten...	96 KB
osbs.dll	09-Dec-22 19:19	Application exten...	111 KB
osgui.dll	09-Dec-22 19:19	Application exten...	175 KB
sewer.dll	09-Dec-22 19:19	Application exten...	215 KB

9.3.2. Disadvantages of DLLs

The main drawback of using DLLs is the incompatibility that may arise between the different versions of a library. Suppose we launch a first version of the three products:

casino.dll	102,127	(v1)
Die.exe	84,100	(v1)
Dice.exe	73,430	(v1)

A few months later, we released a new version of the application `Dice.exe` that involves changes to `casino.dll`. In that case, the distribution of our *suite* would look like this:

casino.dll	106,386	(v2)*
Die.exe	84,100	(v1)?
Dice.exe	78,491	(v2)*

If we have not been very careful, it is very likely that `Die.exe` will no longer work as it is not compatible with the new version of the DLL. This problem bothers many developers and has been named *DLL Hell*². Since in this example we are working in a “controlled” environment we could solve it without too many problems, creating a new version of all the applications running under `casino.dll (v2)`.

casino.dll	106,386	(v2)
Die.exe	84,258	(v2)
Dice.exe	78,491	(v2)

This will not always be possible. Now suppose that our company develops only `casino.dll` and third parties work on the final products. Now each product will have its production and distribution cycles (uncontrolled environment) so, to avoid problems, each company will include a copy of the specific version of the DLL with which its product works. This could lead to the following scenario:

/Apps/Die		
casino.dll	114,295	(v5)
Die.exe	86.100	(v8)
/Apps/Dice		
casino.dll	106,386	(v2)
Dice.exe	72,105	(v1)

Seeing this we sense that the benefits of using DLLs are no longer so great, especially in relation to the optimization of space and loading times. The fact is that it can get even worse. Typically, libraries are written to be as generic as possible and can serve many applications. In many cases, a specific application uses only a few functions in each library with which it links. Using static libraries, the size of the executable (Figure 9.8) can be considerably reduced, since the linker knows perfectly well which specific functions the application uses and adds the strictly necessary code. However, using DLLs, we must distribute the complete library no matter how few functions the executable uses (Figure 9.9). In this case, you are wasting space and unnecessarily increasing application loading times.

9.3.3. Check links with DLLs

When an executable is launched, for example `Die.exe`, all the dynamic libraries linked to it are loaded into memory (if they do not previously exist). If there is a problem during loading, **the executable will not be able to start** and the operating system will display some type of error.

²https://en.wikipedia.org/wiki/DLL_Hell

Figure 9.8: With static libraries, the space and loading times of this application are optimized.

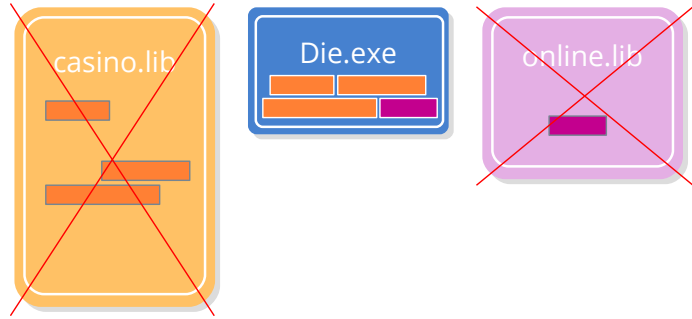
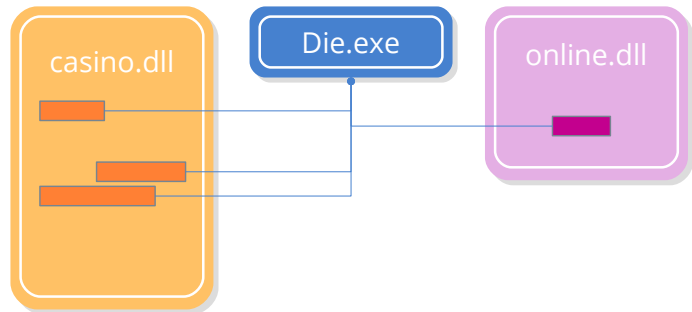

Figure 9.9: With dynamic libraries, this application takes up more than it should and its loading times increase.



Links in Windows

Windows will display an error message (Figure 9.10) when it cannot load a DLL associated with an executable.

Figure 9.10: Error loading DLL casino.

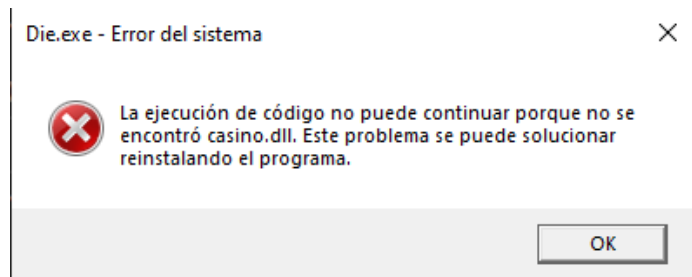

If we want to see which DLLs are linked to an executable, we will use the `dumpbin` command.

```
dumpbin /dependents Die.exe
```

```
Dump of file Die.exe
```

```
File Type: EXECUTABLE IMAGE
```

```
Image has the following dependencies:
```

```
casino.dll
```

```

KERNEL32.dll
USER32.dll
GDI32.dll
SHELL32.dll
COMDLG32.dll
gdiplus.dll
SHLWAPI.dll
COMCTL32.dll
UxTheme.dll
WS2_32.dll

```

We see, at the beginning, the dependency with `casino.dll`. The rest are Windows libraries related to the kernel and the user interface. In the case that we make a `casino` static link:

```

dumpbin /dependents Die.exe

Dump of file Die.exe

File Type: EXECUTABLE IMAGE

Image has the following dependencies:

    KERNEL32.dll
    USER32.dll
    GDI32.dll
    SHELL32.dll
    COMDLG32.dll
    gdiplus.dll
    SHLWAPI.dll
    COMCTL32.dll
    UxTheme.dll
    WS2_32.dll

```

`casino.dll` no longer appears, having been statically linked within `Die.exe`.

Links in Linux

In Linux something similar happens, we will get an error if it is not possible to load a dynamic library (`*.so`).

```

~/ $ ./Die
./Die: error while loading shared libraries: libcasino.so: cannot open shared
  ↪ object file: No such file or directory

```

To check which libraries are linked to an executable we use the `ldd` command.

```

~/ $ ldd ./Die
linux-vdso.so.1 (0x00007fff58036000)
libcasino.so => libcasino.so (0x00007f6848bf4000)

```

```

libpthread.so.0 => /lib/x86_64-linux-gnu/libpthread.so.0 (0x00007f6848bba000)
libgtk-3.so.0 => /lib/x86_64-linux-gnu/libgtk-3.so.0 (0x00007f6848409000)
libgdk-3.so.0 => /lib/x86_64-linux-gnu/libgdk-3.so.0 (0x00007f6848304000)
libpangocairo-1.0.so.0 => /lib/x86_64-linux-gnu/libpangocairo-1.0.so.0 (0
    ↪ x00007f68482f2000)
libpango-1.0.so.0 => /lib/x86_64-linux-gnu/libpango-1.0.so.0 (0
    ↪ x00007f68482a3000)
libcairo.so.2 => /lib/x86_64-linux-gnu/libcairo.so.2 (0x00007f684817e000)
libgdk_pixbuf-2.0.so.0 => /lib/x86_64-linux-gnu/libgdk_pixbuf-2.0.so.0 (0
    ↪ x00007f6848156000)
libgio-2.0.so.0 => /lib/x86_64-linux-gnu/libgio-2.0.so.0 (0x00007f6847f75000)
libgobject-2.0.so.0 => /lib/x86_64-linux-gnu/libgobject-2.0.so.0 (0
    ↪ x00007f6847f15000)
libglib-2.0.so.0 => /lib/x86_64-linux-gnu/libglib-2.0.so.0 (0x00007f6847dec000)
libm.so.6 => /lib/x86_64-linux-gnu/libm.so.6 (0x00007f6847c9d000)
libc.so.6 => /lib/x86_64-linux-gnu/libc.so.6 (0x00007f6847aa9000)
...

```

Where we see that `Die` depends on `libcasino.so`. The rest are dependencies on the Linux kernel, the C standard library and GTK.

Links in macOS: We use the `otool` command.

```

% otool -L ./Die.app/Contents/MacOS/Die
@rpath/libcasino.dylib
/System/Library/Frameworks/Cocoa.framework/Versions/A/Cocoa
/System/Library/Frameworks/UniformTypeIdentifiers.framework/Versions/A/
    ↪ UniformTypeIdentifiers
/usr/lib/libc++.1.dylib
/usr/lib/libSystem.B.dylib
/System/Library/Frameworks/AppKit.framework/Versions/C/AppKit
/System/Library/Frameworks/CoreFoundation.framework/Versions/A/CoreFoundation
/System/Library/Frameworks/CoreGraphics.framework/Versions/A/CoreGraphics
/System/Library/Frameworks/CoreText.framework/Versions/A/CoreText
/System/Library/Frameworks/Foundation.framework/Versions/C/Foundation
/usr/lib/libobjc.A.dylib

```

9.3.4. Loading DLLs at runtime

Until now, the import of DLL symbols is resolved at compile time or, rather, at link time. This means that:

- Executables can directly access global variables and functions defined in the DLL. Going back to the code of `Dice.exe`, we have:

```

#include "ddraw.h"
...
static void i_OnRedraw(App *app, Event *e)
{
    const EvDraw *params = event_params(e, EvDraw);

```

```

color_t green = color_rgb(102, 153, 26);
real32_t w = params->width / 3;
real32_t h = params->height / 2;
real32_t p = kDEF_PADDING;
real32_t c = kDEF_CORNER;
real32_t r = kDEF_RADIUS;
draw_clear(params->ctx, green);
die_draw(params->ctx, 0.f, 0.f, w, h, p, c, r, app->face[0]);
die_draw(params->ctx, w, 0.f, w, h, p, c, r, app->face[1]);
die_draw(params->ctx, 2 * w, 0.f, w, h, p, c, r, app->face[2]);
die_draw(params->ctx, 0.f, h, w, h, p, c, r, app->face[3]);
die_draw(params->ctx, w, h, w, h, p, c, r, app->face[4]);
die_draw(params->ctx, 2 * w, h, w, h, p, c, r, app->face[5]);
}

```

- A #include "ddraw.h" has been made, public header of casino.
- The symbols die_draw(), kDEF_PADDING, kDEF_CORNER, kDEF_RADIUS, defined in ddraw.h, have been used.
- The dynamic library casino.dll will load automatically just before Dice.exe.
- Using a static or dynamic version of casino does not imply changes to the Dice code. We would only have to change the casino/CMakeLists.txt and recompile the solution.

casino/CMakeLists.txt

```

# Static library
nap_library(casino "" NO NRC_NONE)
target_include_directories(casino PUBLIC "${NAPPGUI_INCLUDE_PATH}")

# Dynamic library
nap_library(casino "" YES NRC_NONE)
target_include_directories(casino PUBLIC "${NAPPGUI_INCLUDE_PATH}")

```

However, there is the possibility that the programmer is in charge of loading, downloading and accessing the symbols of the DLLs at any time. This is known as run-time linking or non-symbol import linking. In (Listing 9.1) we have a new version of Dice:

Listing 9.1: Loading symbols at runtime.

```

typedef void (*FPtr_ddraw)(DCTX*, const real32_t, const real32_t, const real32_t
↳ , const real32_t, const real32_t, const real32_t, const real32_t, const
↳ uint32_t);

static void i_OnRedraw(App *app, Event *e)
{
    const EvDraw *params = event_params(e, EvDraw);
    DLib *casino = dlib_open(NULL, "casino");
    FPtr_ddraw func_draw = dlib_proc(casino, "die_draw", FPtr_ddraw);
}

```

```

color_t green = color_rgb(102, 153, 26);
real32_t w = params->width / 3;
real32_t h = params->height / 2;
real32_t p = *dlib_var(casino, "kDEF_PADDING", real32_t);
real32_t c = *dlib_var(casino, "kDEF_CORNER", real32_t);
real32_t r = *dlib_var(casino, "kDEF_RADIUS", real32_t);
draw_clear(params->ctx, green);
func_draw(params->ctx, 0.f, 0.f, w, h, p, c, r, app->face[0]);
func_draw(params->ctx, w, 0.f, w, h, p, c, r, app->face[1]);
func_draw(params->ctx, 2 * w, 0.f, w, h, p, c, r, app->face[2]);
func_draw(params->ctx, 0.f, h, w, h, p, c, r, app->face[3]);
func_draw(params->ctx, w, h, w, h, p, c, r, app->face[4]);
func_draw(params->ctx, 2 * w, h, w, h, p, c, r, app->face[5]);
dlib_close(&casino);
}

```

- Line 6 loads the `casino` library.
- Line 7 accesses the function `die_draw` defined in `casino`.
- Lines 11-13 access public `casino` variables.
- Lines 15-20 use `die_draw` through the `func_draw` pointer.
- Line 21 unloads the `casino` library from memory.

As we see, this loading at runtime does imply changes to the source code, but it also brings with it certain advantages:

- The library is loaded when we need it, not at the beginning of the program. This is why it is **very important** that `casino` does not appear as a dependency of `Dice`.

```
nap_desktop_app(Dice "" NRC_NONE)
```

- We can have different versions of `casino` and choose which one to use at runtime. This is the working mechanism of the *plug-ins* used by many applications. For example, the *Rhinoceros 3D* program enriches its functionality thanks to new commands implemented by third parties and added at any time through a system of plugins (.DLLs) (Figure 9.11).

9.3.5. Location of DLLs

When the operating system must load a dynamic library, it follows a certain search order. On Windows systems search in this order:

- The same directory as the executable.
- The current working directory.
- The directory `%SystemRoot%\System32`.

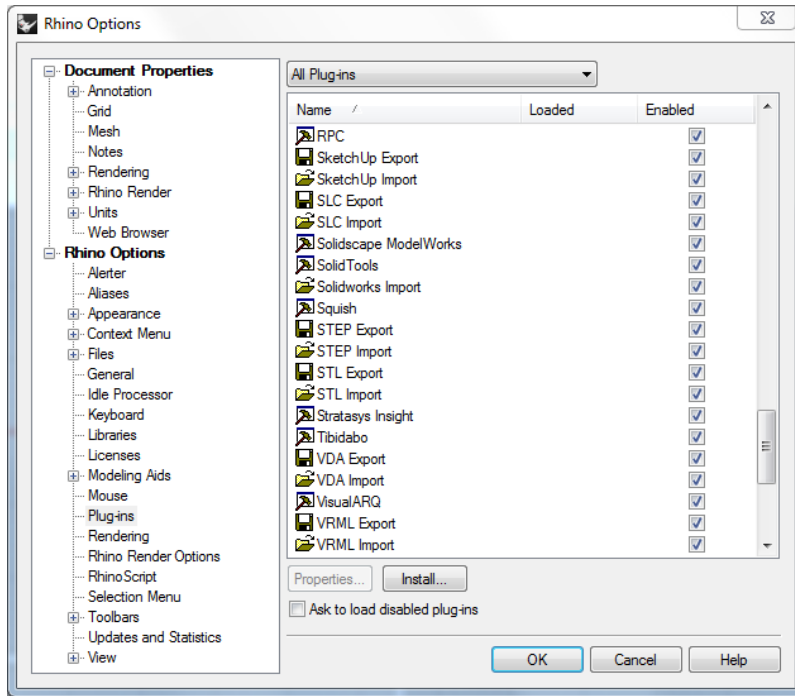

Figure 9.11: Rhinoceros 3D plug-in system, implemented using DLLs.

- The directory %SystemRoot%.
- The directories specified in the PATH environment variable.

On the other hand, on Linux and macOS:

- The directories specified in the environment variable LD_LIBRARY_PATH (Linux) or DYLD_LIBRARY_PATH (macOS).
- The directories specified in the executable rpath.
- The system directories /lib, /usr/lib, etc.

Here we have a big difference between Windows and Unix, since in the latter it is possible to add dependencies search directories within the executable. This variable is known as **RPATH** and is not available on Windows. To check the value of RPATH:

```
// In Linux
~/ $ readelf -d ./Die | grep RUNPATH
0x000000000000001d (RUNPATH)           Library runpath: [${ORIGIN}]

// In macOS
otool -l ./Die.app/Contents/MacOS/Die
...
```

```
Load command 25
  cmd LC_RPATH
  cmdsize 40
  path @executable_path/../../../../ (offset 12)
...
```

Executables generated by the `nap_desktop_app()` command automatically set the `RPATH` to find dynamic dependencies in the same directory as executables on Linux or bundles on macOS.

9.4. Symbols and visibility

In the linking process after the compilation of the library, those elements that can generate machine code or take up space in the final binary are called **symbol**. These are methods, functions and global variables. Symbols are not considered:

- Type definitions such as `enum`, `struct` or `union`. These help the programmer organize the code and the compiler validate it, but they do not generate any binary code. They do not exist from the linker's point of view.
- Local variables. These are automatically created and destroyed in the “*Stack Segment*” (page 169) during program execution. They do not exist at link time.

On the other hand, all functions and global variables declared as `static` within a module `*.c` will be considered **private symbols** not visible in link time and where the compiler is free to make the appropriate optimizations. With this in mind, the code within NAppGUI is organized as follows:

- ***.c**: Implementation file. Definition of symbols (functions and global variables).
- ***.h**: Public header file. Declaration of functions and global variables (`extern`), available to the library user.
- ***.hxx**: Declaration of public types: `struct`, `union` and `enum`.
- ***.inl**: Declaration of functions and private variables. Only the internal modules of the library will have access to these symbols.
- ***.ixx**: Declaration of private types. Those shared between the library modules, but not with the outside.

If a function is only needed within a `.c` module, it is not included in a `*.inl`. It will be marked as `static` within the same `*.c`. This way it will not be visible to the linker and will allow the compiler to perform optimizations.*

*Likewise, types that are only used within a specific module will be declared at the beginning of *.c and not in *.ixx.*

For the sake of code maintainability and scalability, type and function declarations will be kept as private as possible.

9.4.1. Export in DLLs

When we generate a dynamic link library, in addition to including public symbols in one or more *.h headers, we must explicitly mark them as exportable. The export macro is declared in the *.def file of each library. For example in casino.def, the macro _casino_api is defined.

Listing 9.2: casino.def

```

/* casino library import/export */

/* clang-format off */

#if defined(NAPPGUI_SHARED)
    #if defined(NAPPGUI_BUILD_CASINO_LIB)
        #define NAPPGUI_CASINO_EXPORT_DLL
    #else
        #define NAPPGUI_CASINO_IMPORT_DLL
    #endif
#endif

#if defined(__GNUC__)
    #if defined(NAPPGUI_CASINO_EXPORT_DLL)
        #define _casino_api __attribute__((visibility("default")))
    #else
        #define _casino_api
    #endif
#elif defined(_MSC_VER)
    #if defined(NAPPGUI_CASINO_IMPORT_DLL)
        #define _casino_api __declspec(dllimport)
    #elif defined(NAPPGUI_CASINO_EXPORT_DLL)
        #define _casino_api __declspec(dllexport)
    #else
        #define _casino_api
    #endif
#else
    #error Unknown compiler
#endif

/* clang-format on */

```

This macro must precede all public functions and variables declared in the *.h of the li-

brary. Projects based `nap_desktop_app()` will define the macros `NAPPGUI_XXXXX_EXPORT_DLL` when the DLL is compiled and `NAPPGUI_XXXXX_IMPORT_DLL` when the DLL is used in other targets. This way, the export and import of symbols will be done correctly on all platforms.

9.4.2. Checking in DLLs

We can see, from the binary of a dynamic library, what public symbols it exports. On Windows we will use `dumpbin /exports dllname`, on Linux `nm -D soname` and on macOS `nm -gU dylibname`.

Public `core.dll` symbols (Windows).

```
C:\>dumpbin /exports core.dll
2   1 00001000 array_all
3   2 00001010 array_bsearch
4   3 00001090 array_bsearch_ptr
5   4 00001120 array_clear
6   5 000011C0 array_clear_ptr
7   6 00001260 array_copy
8   7 00001340 array_copy_ptr
9   8 00001420 array_create
10  9 00001430 array_delete
11  A 00001530 array_delete_ptr
12  B 00001640 array_destopt
13  C 00001650 array_destopt_ptr
14  D 00001660 array_destroy
15  E 000016F0 array_destroy_ptr
16  F 00001790 array_esize
17 10 000017A0 array_find_ptr
18 11 000017D0 array_get
...
```

Public `libcore.so` symbols (Linux).

```
$ nm -D ./libcore.so
0000000000011f85 T array_all
000000000001305c T array_bsearch
000000000001316d T array_bsearch_ptr
0000000000011832 T array_clear
00000000000118a1 T array_clear_ptr
0000000000011009 T array_copy
000000000001115d T array_copy_ptr
0000000000010fdd T array_create
0000000000012649 T array_delete
000000000001276b T array_delete_ptr
0000000000011668 T array_destopt
0000000000011746 T array_destopt_ptr
00000000000115c3 T array_destroy
00000000000116ad T array_destroy_ptr
```

```
0000000000011b87 T array_esize
0000000000012dd3 T array_find_ptr
0000000000011e8c T array_get
```

Public libcore.dylib symbols (macOS).

```
% nm -gU ./libcore.dylib
0000000000029f0 T _array_all
000000000003c90 T _array_bsearch
000000000003d60 T _array_bsearch_ptr
0000000000024c0 T _array_clear
0000000000025d0 T _array_clear_ptr
000000000001c20 T _array_copy
000000000001dd0 T _array_copy_ptr
000000000001b50 T _array_create
0000000000030f0 T _array_delete
000000000003350 T _array_delete_ptr
0000000000022f0 T _array_destopt
000000000002470 T _array_destopt_ptr
000000000002120 T _array_destroy
000000000002340 T _array_destroy_ptr
0000000000028b0 T _array_esize
000000000003980 T _array_find_ptr
0000000000028f0 T _array_get
```

Resources

If we internationalize everything, we end up with rules that stifle freedom and innovation.

Myron Scholes

10.1 Resources	99
10.2 Types of resources	100
10.3 Create resources	101
10.4 Internationalization (i18n)	102
10.5 Runtime translation	104
10.6 Edit resources	106
10.7 Manual management	106
10.8 Resource processing	107
10.9 Resource distribution	107
10.10 nrc warnings	109
10.11 Application icon	110

10.1. Resources

Resources are data that are required by the application but do not reside in the area of the executable. In other words, they are not directly accessible through program variables, but rather have to be pre-loaded before they can be used. The most common are the texts and images used in the user interface, although any type of file can become a resource (sounds, fonts, 3d models, html pages, etc). To illustrate its use with a real example, we return to the `Die` application (Figure 10.1), already covered in previous chapters.

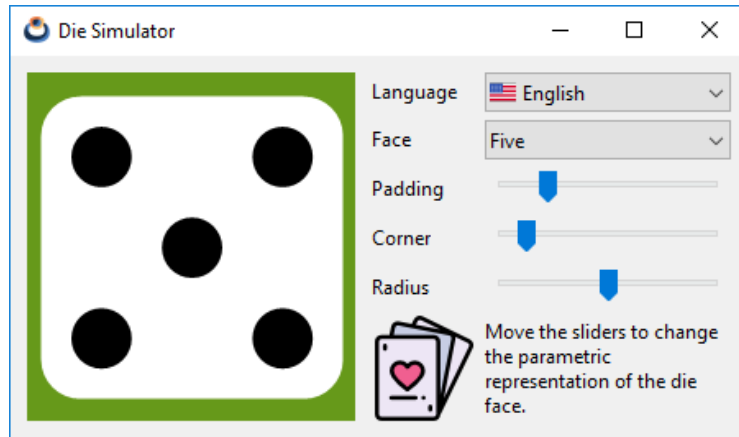

Figure 10.1: Die Application.

10.2. Types of resources

- **Texts:** Although it is very easy to include texts in the code as C variables, in practice this is not advisable for two reasons: The first is that, normally, it is not the programmers who They compose the messages that the program displays. By separating them into a separate file, other team members can review and edit them without having to directly access the code. The second reason is internationalization. It is an almost essential requirement today to be able to change the language of the program and this can involve several members of the team, as well as the fact that several text strings refer to the same message. Therefore, extracting them from the source code will be almost essential.
- **Images:** It is not usual for the program icons to change depending on the language, although it may be the case. The tricky thing here is transforming a .jpg or .png file into a C variable (Listing 10.1). You have to serialize the file and paste it into the code, something very tedious and difficult for the programmer to maintain. It is preferable to have the images in a separate folder and access them at runtime.

Listing 10.1: Png image embedded in the source code.

```
const uint32_t IMG_SIZE = 1262;

const byte_t IMG[] = {
    0x89, 0x50, 0x4E, 0x47, 0x0D, 0x0A, 0x1A, 0x0A,
    0x00, 0x00, 0x00, 0x0D, 0x49, 0x48, 0x44, 0x52,
    ... };
```

- **Files:** Apart from text and images, any file can become a resource. In this case, the application will receive a block of bytes with its content, which it must know how to interpret.

10.3. Create resources

If we go to the source directory of the application (`/die`), we see that there is a folder called `/res` added by CMake when creating the project. Inside there are several `logo.*` files with the “*Application icon*” (page 110).

You can also see a folder called `/res/res_die` which **wasn’t created by CMake**, but added later when writing the program. This subfolder is considered a **resource pack** and will contain a set of texts, images or files that will be loaded “in bulk” at some point in the execution. We can create as many packages as necessary depending on the size and logic of our program.

In large applications, organize your resources in such a way that it is not necessary to load all of them when starting the application. Certain resources may only be needed when the user performs some action.

You will see that inside `/res/res_die` there is a `strings.msg` whose content is shown below:

Listing 10.2: Die’s message file.

```

/* Die strings */
TEXT_FACE      Face
TEXT_PADDING   Padding
TEXT_CORNER    Corner
TEXT_RADIUS    Radius
TEXT_ONE       One
TEXT_TWO       Two
TEXT_THREE     Three
TEXT_FOUR      Four
TEXT_FIVE      Five
TEXT_SIX       Six
TEXT_TITLE     Die Simulator
TEXT_INFO      Move the sliders to change the parametric representation of the
    ↔ die face.
TEXT_LANG      Language
TEXT_ENGLISH   English
TEXT_SPANISH   Spanish

```

Also contains the `cards.png` image and the `spain.png` and `usa.png` (Figure 10.2) icons.

Each line within the `strings.msg` file defines a new message consisting of an identifier (eg `TEXT_FACE`) followed by the text to be displayed in the program (`Face` in this case). Text is considered from the first non-blank character after the identifier to the end of the line. You don’t need to put it in quotes (“`Face`”) like you do in C:

```

BILLY    Billy "the Kid" was an American Old West outlaw.

```

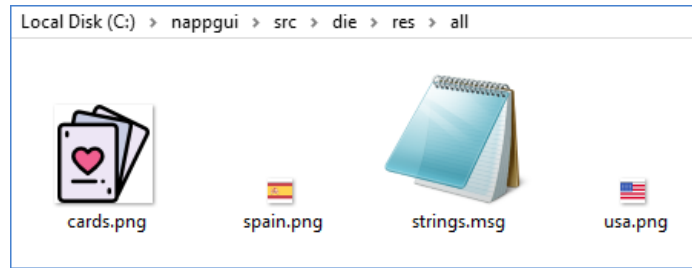

Figure 10.2: Resource bundle at `src/die/res/res_die`.

```
OTHER    Other text.
```

You also don't have to use escape sequences (`'\\'`, `'\"'`, ...), with the single exception of `'\n'` for multi-line messages:

```
TWO_LINES  This is the first line\nAnd this is the second.
```

The message identifier follows the rules for C identifiers, except that letters must be uppercase:

```
_ID1      Ok
0ID2      Wrong!!
id3       Wrong!!
ID3       Ok
```

Messages accept any Unicode character. We can split the texts into as many `*.msg` files as needed and they must be stored in **UTF8 format**.

Visual Studio does not save files in UTF8 by default. Be sure to do so on every `.msg` that contains non-US-ASCII characters. `File->Save As->Save with encoding->Unicode (UTF8 Without Signature)- Codepage 65001`.*

10.4. Internationalization (i18n)

We have used English as the main language in the program, but we want it to be translated into Spanish as well. To do this we go back to the `/res/res_die` folder, where we see the `/es_es` subdirectory that contains another `strings.msg` file. The identifiers in that file are the same as in `/res_die/strings.msg` but the texts are in another language. Depending on the selected language, the program will use one version or another.

Listing 10.3: Die's message file, translated into Spanish.

```
/* Die strings */
TEXT_FACE      Cara
TEXT_PADDING   Margen
TEXT_CORNER    Borde
```

```

TEXT_RADIUS      Radio
TEXT_ONE         Uno
TEXT_TWO         Dos
TEXT_THREE       Tres
TEXT_FOUR        Cuatro
TEXT_FIVE        Cinco
TEXT_SIX         Seis
TEXT_TITLE       Simulador de dado
TEXT_INFO        Mueve los sliders para cambiar la representación paramétrica de
    ↔ la cara del dado.
TEXT_LANG        Idioma
TEXT_ENGLISH     Inglés
TEXT_SPANISH     Español

```

We must take into account some simple rules when locating resources:

- If the local version of a resource does not exist, the global version of the resource will be used. CMake will warn if there is **untranslated text** “*nrc warnings*” (page 109).
- Those resources only present in local folders will be ignored. It is imperative that the global version of each exists.
- Resource “subpackages” are not allowed. Only two levels will be processed: `src/res/packname` for globals and `src/res/packname/local` for locals.
- Resource bundles must have a unique name within the solution. One strategy might be to prepend the project name: `/appname_pack1`, `libname_pack2`, etc.
- Existing resources in the root folder (`/res`) will be ignored. All resources must be contained in a package `/res/pack1/`, `/res/pack2/`, etc.
- Localized texts must have the same identifier as their global counterpart. Otherwise they are considered different messages.
- To create a localized version of an image or other file, include it in its corresponding local folder (e.g. `/res/res_die/es_es/cards.png`) using **the same file name** than the global version.
- To name the localized folders, use the two-letter language code ISO 639-1¹ (in, is, fr, de, zh, ...) and, optionally, the two-letter country code ISO-3166² (en_us, en_gb, ...).

¹https://en.wikipedia.org/wiki/List_of_ISO_639-1_codes

²https://en.wikipedia.org/wiki/ISO_3166-1

10.5. Runtime translation

For each resource bundle, CMake creates a *.h with the same name as the folder: res_die.h in this case (Listing 10.4) . This file contains the resource identifiers, as well as a function that allows us to access them res_die_respack(). In (Listing 10.5) we see the actions to be carried out to use these resources in our program.

Listing 10.4: Header file res_die.h.

```

/* Automatic generated by NAppGUI Resource Compiler (nrc-r1490) */

#include "core.hxx"

__EXTERN_C

/* Messages */
extern ResId TEXT_FACE;
extern ResId TEXT_PADDING;
extern ResId TEXT_CORNER;
extern ResId TEXT_RADIUS;
extern ResId TEXT_ONE;
extern ResId TEXT_TWO;
extern ResId TEXT_THREE;
extern ResId TEXT_FOUR;
extern ResId TEXT_FIVE;
extern ResId TEXT_SIX;
extern ResId TEXT_TITLE;
extern ResId TEXT_INFO;
extern ResId TEXT_LANG;
extern ResId TEXT_ENGLISH;
extern ResId TEXT_SPANISH;

/* Files */
extern ResId CARDS_PNG;
extern ResId SPAIN_PNG;
extern ResId USA_PNG;

ResPack *res_die_respack(const char_t *local);

__END_C

```

Listing 10.5: Load and use of resources.

```

#include "res_die.h"

gui_respack(res_die_respack);
gui_language("");
...
label_text(label1, TEXT_FACE);
imageview_image(vimg, CARDS_PNG);
...

```

```

static void i_OnLang(App *app, Event *e)
{
    const EvButton *params = event_params(e, EvButton);
    const char_t *lang = params->index == 0 ? "en_us" : "es_es";
    gui_language(lang);
    unref(app);
}

```

- Line 1 includes the (Listing 10.4) resource bundle header, which is automatically generated by CMake.
- Line 3 registers the package in “Gui” (page 305), the library in charge of the graphical interface. If the application had more resource packs we would add them in the same way.
- Line 4 sets the default language (English).
- Lines 6 and 7 assign a text and an image to two controls respectively. Identifiers are defined in “res_die.h”, as we just saw.
- Line 13 translates the entire interface in response to a change in the “PopUp” (page 319) control (Figure 10.3).

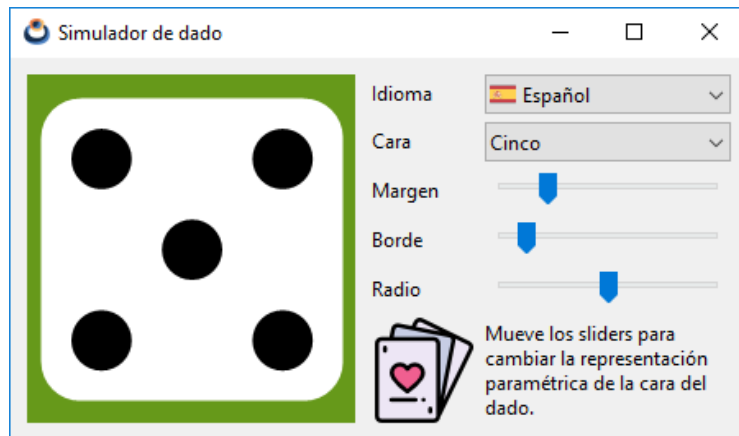

Figure 10.3: Translation of the Die application, without destroying the window or rebooting.

Basically, a call to `gui_language`, involves coordinating three actions:

- Load the located resources and replace them with the current ones.
- Assign the new texts and images to all the controls and menus of the program.
- Resize the windows and menus, since changing texts and images will influence the size of the controls.

10.6. Edit resources

To add new resource files or delete any of the existing ones, we just have to go to the `res/res_die` folder through the file explorer and do it there directly. The `*.msg` message files can be edited from within Visual Studio, as CMake includes them within the (Figure 10.4) IDE. After making any changes to the resource folder or editing a `*.msg` file, we must relaunch CMake so that these modifications are integrated back into the project. After each update, the identifiers of the new resources will be created and those whose associated resource has disappeared will be deleted, which will cause compilation errors that will facilitate the correction of the code.

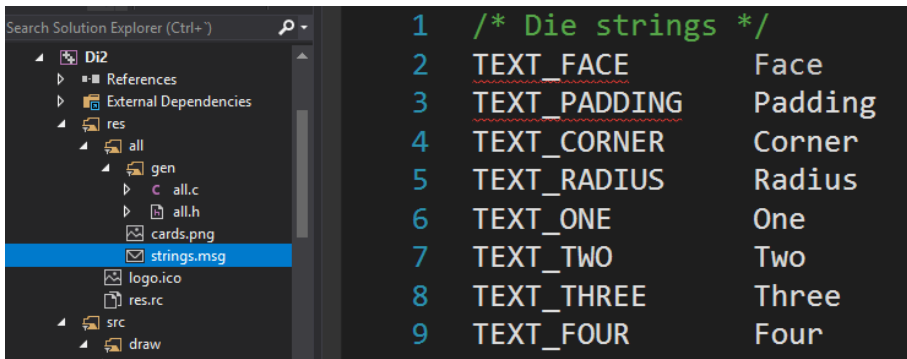

Figure 10.4: Editing resources within Visual Studio.

10.7. Manual management

Although the usual thing will be to delegate the management of resources to the `gui` library, it is possible to access the content of the packages directly, as we see in (Listing 10.6).

Listing 10.6: Direct access to resources.

```
#include "res_die.h"

ResPack *pack = res_die_respack("es_es");
...
label_text(label1, respack_text(pack, TEXT_FACE));
imageview_image(vimg, image_from_resource(pack, CARDS_PNG));
...
respack_destroy(&pack);
```

- Line 1 includes the resource bundle header.
- Line 3 creates an object with the content of the package in the Spanish language. Each resource pack will provide its own constructor, whose name will start with the

name of its `xxxx_respack()` folder.

- Lines 5 and 6 get a text and an image respectively to assign to interface controls.
- Line 8 destroys the resource bundle, at the end of its use.

There is a big difference between allocating resources using `ResId` or using `respack_` (Listing 10.7) functions. In the first case, the label control will be “sensitive” to language changes made by `gui_language`. However, in cases 2 and 3 a constant text has been assigned to the control, which will not be affected by this function. We will be responsible for changing the text, if necessary.

Listing 10.7: Different ways to access resources.

```
label_text(label1, TEXT_FACE);
label_text(label1, respack_text(pack, TEXT_FACE));
label_text(label1, "Face");
```

The choice of one access mode or another will depend on the requirements of the program. We remind you that in order to carry out automatic translations, resources must be registered with `gui_respack`.

10.8. Resource processing

Let’s see in a little more detail how NAppGUI generates resource modules. By setting `NRC_EMBEDDED` in the `nap_desktop_app()` command, we tell CMake to process the Die project’s resources. We can also choose the `NRC_PACKED` option which we will talk about below. When we launch CMake, the subfolders within the `res` directory of each project are traversed, calling the `nrc` (*NAppGUI Resource Compiler*) utility (Figure 10.5). This program is located in the `/bin` folder of the SDK distribution. For each resource package, `nrc` creates two source files (a `.c` and a `.h`) and links them to the project. The `.h` contains the identifiers and the constructor that we have seen in (Listing 10.4). For its part, `.c` implements the package implementation based on the content of each folder and the `nrcMode` mode.

Files created by `nrc` are considered generated code and are not stored in the `src` folder but in the `build` folder. They will be updated every time CMake is run, regardless of the platform we are working on. In contrast, the original resource files (located in the `res` folder) are considered part of the source code.

10.9. Resource distribution

In the previous chapter, when creating the Visual Studio solution, we indicated that the `NRC_EMBEDDED` constant had to be used in the `nap_desktop_app()` statement within the

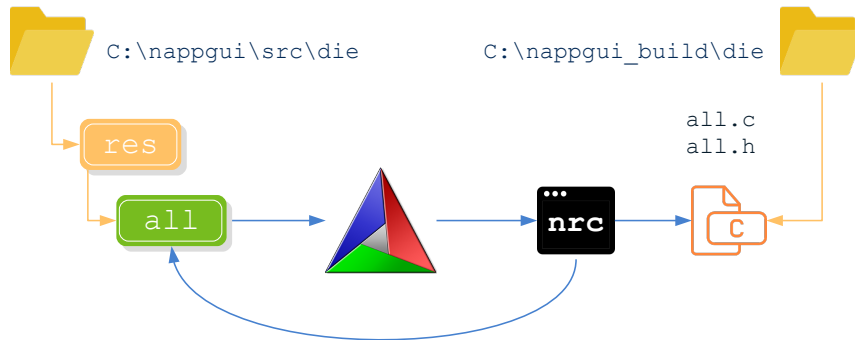

Figure 10.5: Processing resources using CMake and nrc.

`CMakeLists.txt` file. There are two other modes related to resource management that can be configured separately within each command `nap_desktop_app()`, `nap_command_app()` or `nap_library()`:

- `NRC_NONE`: CMake will ignore the contents of the `res` folder, except for the application icon. No resource packs will be generated even if there is content inside this folder.
- `NRC_EMBEDDED`: The resources, with all their translations, are embedded as part of the (Figure 10.6) executable. It is a very interesting option for small or medium-sized applications, since we will supply the entire program in a single `*.exe` file. An installer will not be necessary and we will have the certainty that the software will not fail due to the lack of some external file. The drawback is that, obviously, the size of the executable will grow considerably, so it is not advisable in programs with many resources, very heavy, or with a multitude of translations.
- `NRC_PACKED`: For each resource package, a `*.res` file will be created external to the executable that will be loaded and released at runtime as needed (Figure 10.7). The advantages of this method are the disadvantages of the previous one and vice versa: Smaller executables, but with external dependencies (the `.res` themselves) that must be distributed together. Memory usage will also be optimized by being able to load `*.res` on demand.

CMake manages the location of the resource packages for us. On Windows and Linux applications it will copy all `*.res` into the executable directory. On macOS it will place them in the `resources` folder of the bundle. A very important fact is that **we don't have to modify the source code** when switching from one modality to another. `nrc` already takes care of managing the payload based on the package type. It makes sense to start with `NRC_EMBEDDED`, and if the project grows, change to `NRC_PACKED`. We just have to launch CMake again and recompile the project for the change to take effect.

Name	Date Modified	Size	Kind
▼ Contents	Today at 18:09	--	Folder
Info.plist	Today at 18:09	1 KB	Property List
▼ MacOS	Today at 18:09	--	Folder
Products	Today at 18:09	948 KB	Unix executable
PkgInfo	Today at 18:09	8 bytes	TextEdit
resources	Today at 18:09	--	Folder
▶ en.lproj	Today at 18:09	--	Folder
logo.icns	Today at 18:09	302 KB	Apple i...n image

Figure 10.6: Distributing a macOS application with embedded resources.

Name	Date Modified	Size	Kind
▼ Contents	Today at 18:11	--	Folder
Info.plist	Today at 18:11	1 KB	Property List
▼ MacOS	Today at 18:11	--	Folder
Products	Today at 18:11	359 KB	Unix executable
PkgInfo	Today at 18:11	8 bytes	TextEdit
resources	Today at 18:11	--	Folder
▶ en.lproj	Today at 18:11	--	Folder
logo.icns	Today at 18:11	302 KB	Apple i...n image
res_db.res	Today at 18:11	526 KB	Document
res_gui.res	Today at 18:11	22 KB	Document
res_user.res	Today at 18:11	36 KB	Document

Figure 10.7: A distribution of the same macOS app with packed resources.

*On Windows and Linux the *.res files must always be installed in the same directory as the executable. For macOS, CMake generates a distribution-ready bundle and installs the resource bundles in the /resources directory of that bundle.*

10.10. nrc warnings

nrc is a silent script whose work is integrated into the CMake *build process*, mostly unnoticed. But there are times when you detect anomalies in the resource directories and you need to let us know in some way. In these cases a red line will appear in the CMake console indicating the affected project and package(s) (Figure 10.8). The details are dumped into the `NRCLog.txt` file located in the generated resources folder (CMake displays the full path).

If the bugs are critical, *nrc* will not be able to generate the `*.h` and `*.c` associated with the package, preventing the application from crashing. `can compile` (in essence it is still a compilation error). Other times they are mere *warnings* that should be fixed, but they allow you to continue compiling. Specifically, the **critical errors** that affect *nrc* are

```

- HelloCpp: Starting
- HelloCpp: Completed
- Products: Starting
- nrc 'res_gui' warnings (See C:/NAPPGUI_1_0_build/demo/products/resgen/NRCLog.txt)
- Products: Completed
- BlockBreak: Starting
- BlockBreak: Completed
- Die: Starting
- Die: Completed

```

Figure 10.8: *nrc* encountered anomalies while processing resources.

the following: (we show them in English as they are written in `NRCLog.txt`).

- `MsgError (%s:%d): Comment not closed (%s)`.
- `MsgError (%s:%d): Invalid TEXT_ID (%s)`.
- `MsgError (%s:%d): Unexpected end of file after string ID (%s)`.
- Duplicate resource id in '`%s`' (`%s`).
- Can't load resource file '`%s`'.
- Error reading '`%s`' resource directory.
- Error reading '`%s`' subdirectories.
- Error creating '`%s`' header file.
- Error creating '`%s`' source file.
- Error creating '`%s`' packed file.

On the other hand, non-critical warnings:

- Empty message file '`%s`'.
- Ignored localized text '`%s`' in '`%s`'. Global resource doesn't exist.
- Ignored localized file '`%s`' in '`%s`'. Global resource doesn't exist.
- There is no localized version of the text '`%s`' in '`%s`'.
- Localized directory '`%s`' is empty or has invalid resources.

10.11. Application icon

When we create a new project, CMake sets a default icon for the application, which it places in the `/res` directory, with the name `logo*`. This image will be “embedded” in the executable and will be used by the operating system to render the application on the

desktop (Figure 10.9). Windows and Linux also use it in the window title bar. We have three versions:

- **logo256.ico**: Version for Windows Vista and later. They must include the resolutions: 256x256, 48x48, 32x32 and 16x16.
- **logo48.ico**: Version for Linux and VisualStudio 2008 and 2005, which do not support 256x256 resolutions. This version only includes: 48x48, 32x32 and 16x16.
- **logo.icns**: Version for macOS. Resolutions 512x512, 256x256, 128x128, 32x32 and 16x16 both in normal resolution (@1x) and Retina Display (@2x).



Figure 10.9: Application icons on the Windows taskbar.

CMake already takes care of using the appropriate version of the icon depending on the platform we are compiling on. To change the default icon, open the `logo*` files with some graphical editor (Figure 10.10), make the changes, and relaunch CMake. **Very important:** do not change the names of the files, they should always be `logo256.ico`, `logo48.ico` and `logo.icns`.

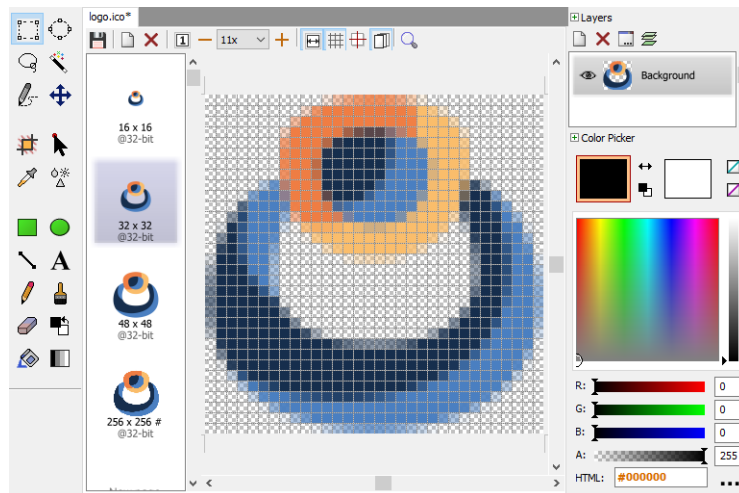

Figure 10.10: Editing `logo.ico`.

Generators, compilers and IDEs

*It's hard to write software that runs correctly and efficiently. So once a program works in one environment, you don't want to repeat much of the effort if you move it to a different compiler or processor or operating system. **Ideally, it should need no changes whatsoever.***

Kernighan & Pike - The Practice of Programming.

11.1	Generators, compilers and IDEs	114
11.2	Portability concept	114
11.3	CMake Generators	115
11.4	Visual Studio	116
11.4.1	Platform toolset	118
11.4.2	Visual C++ Redistributable	119
11.4.3	WindowsXP support	120
11.4.4	SSE support	120
11.5	MinGW	121
11.5.1	MinGW-GCC	121
11.5.2	MinGW-Clang	122
11.5.3	MSYS2	122
11.6	Xcode	123
11.6.1	Base SDK and Deployment Target	126
11.6.2	xcode-select	128
11.6.3	macOS ARM	128
11.6.4	macOS 32bits	130
11.7	macOS Make	131
11.8	Linux GCC	132
11.8.1	Multiple versions of GCC	136
11.8.2	Linux 32bits	137

11.8.3 Linux ARM	137
11.9 Linux Clang	137
11.10 Linux GTK	139
11.11 Ninja	140
11.12 Configurations	141
11.13 Eclipse CDT	143
11.14 Visual Studio Code	144

11.1. Generators, compilers and IDEs

11.2. Portability concept

We understand by **portability** (Figure 11.1) the ability to compile and debug our programs on platforms other than those on which they were written, without having to touch a single line of code. We understand by **platform** the combination of a compiler and a CPU architecture. For example, `v143_x64` refers to Visual Studio 2022 and Intel 64bits. We understand by **configuration** the set of flags and compiler options that have been used to generate the binaries.

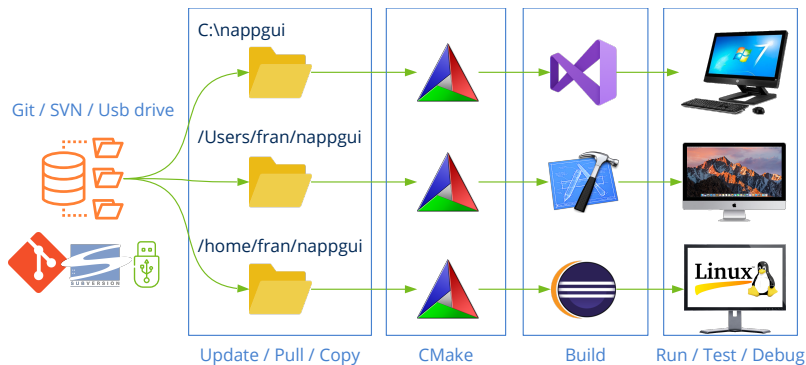

Figure 11.1: Stages in porting code between platforms.

- **Working copy:** A copy of the project's source code must exist on each machine. Normally this will be done through a version control system (SVN, Git, etc).
- **CMake:** will create or update a build project from source code using `/src/CMakeLists.txt` and the scripts in the `/prj` directory. This will be done fully automatically.
- **Compile:** Using Visual Studio, Xcode or GCC, the solution will be compiled and the libraries and executables included in it will be generated.

- **Run/Debug:** The binaries can now be run and debugged on the target platform.

11.3. CMake Generators

We remember that a compiler acts on a single source file at a time. When we compile a `.c` or `.cpp`, an object file (`.o`, `.obj`) is generated that contains the binary code of said source. But any project of a certain size contains hundreds of files, organized in libraries that must be linked to create the final executable(s). We know as **build system** the tool that orchestrates the compilation of all the project files, in order to make it as fast and efficient as possible. We can say that CMake is a meta-build system, capable of generating build projects for different tools (Figure 11.2). To do this we will use the `-G` option.

```
cmake -G "Visual Studio 17 2022"
cmake -G Ninja
cmake -G Xcode
cmake -G "Unix Makefiles"
```

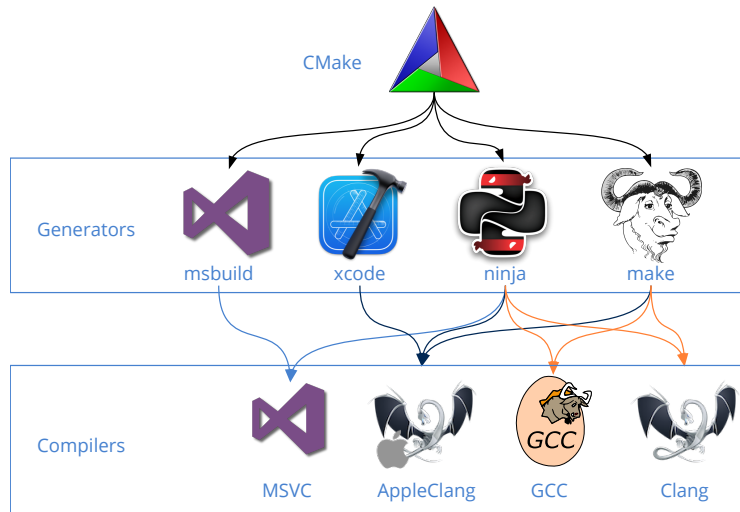

Figure 11.2: Generators and compilers.

Not all generators work on all platforms, and there is usually no strict binding between generator and compiler. For example, the `Ninja` generator can use the `MSVC`, `GCC` and `Clang` compilers underneath. The most important thing we must remember is that CMake, through the `CMakeLists.txt` of the project, unifies the entire build process, making it transparent for the developer, regardless of the generator, compiler and platform.

11.4. Visual Studio

Visual Studio is the development environment par excellence for Windows. In the same package it integrates the build system (msbuild), the compiler (MSVC) and the editor (IDE). We can use any version, starting from 2005, to compile NAppGUI on Windows (Table 11.1). As we already saw in “*Quick start*” (page 5) the first thing we have to do is launch CMake on the source code:









	Compiler	Platform	Minimum O.S.
	Visual Studio 2022	v143_x64 (x86)	Vista
	Visual Studio 2019	v142_x64 (x86)	Vista
	Visual Studio 2017	v141_x64 (x86)	Vista
	Visual Studio 2015	v140_x64 (x86)	Vista
	Visual Studio 2013	v120_x64 (x86)	Vista
	Visual Studio 2012	v110_x64 (x86)	Vista
	Visual Studio 2010	v100_x64 (x86)	XP
	Visual Studio 2008	v90_x64 (x86)	XP
	Visual Studio 2005	v80_x64 (x86)	XP

Table 11.1: Versions of Visual Studio supported by NAppGUI.

```
cmake -G "Visual Studio 16 2019" -A x64 -T v120 -S . -B build
```

- -G is the version of Visual Studio (generator).

```
-G "Visual Studio 17 2022"
-G "Visual Studio 16 2019"
-G "Visual Studio 15 2017"
-G "Visual Studio 14 2015"
-G "Visual Studio 12 2013"
-G "Visual Studio 11 2012"
-G "Visual Studio 10 2010"
-G "Visual Studio 9 2008"
-G "Visual Studio 8 2005"
```

- -A is Intel 32 or 64 bit architecture:

```
-A x64
-A Win32
```

- `-T` is the *Platform Toolset*. If you omit this parameter, the last one supported by the compiler will be taken.

```
-T v143
-T v142
-T v141
-T v140
-T v120
-T v110

// For XP compatibility
-T v141_xp
-T v140_xp
-T v120_xp
-T v110_xp
-T v100
-T v90
-T v80
```

- `-S`: Path where the `CMakeLists.txt` is located.
- `-B`: Path where the build projects, binaries and temporary files will be generated.
- `-DNAPPGUI_DEMO=NO`: Avoid generating the example applications. Only the SDK will be compiled.

Support for Visual Studio 8 2005 was removed in CMake 3.12. You must use an older version of CMake if you are still using VS2005. NAppGUI does NOT work with versions prior to VS2005.

NAppGUI does not offer support for non-x86, x64 architectures on Windows: ARM, Itanium, etc.

After running CMake, a VisualStudio solution will appear in the `/build` folder, `NAppGUI.sln` or whatever name is configured in `project(NAppGUI)` of the `CMakeLists.txt`. Open that solution and from Visual Studio, `Build->Build Solution` to compile `Debug->Start Debugging` to debug (Figure 11.3).

*To change the version of Visual Studio, select another builder in CMake **-G “Visual Studio 15 2017”**, close and reopen the solution.*

As we already saw in “*Build NAppGUI*” (page 65), if your intention is only to compile the SDK, you do not need to open the solution in the editor. You can compile it directly from the command line.

```
cmake -G "Visual Studio 17 2022" -S . -B build -DNAPPGUI_DEMO=NO
```

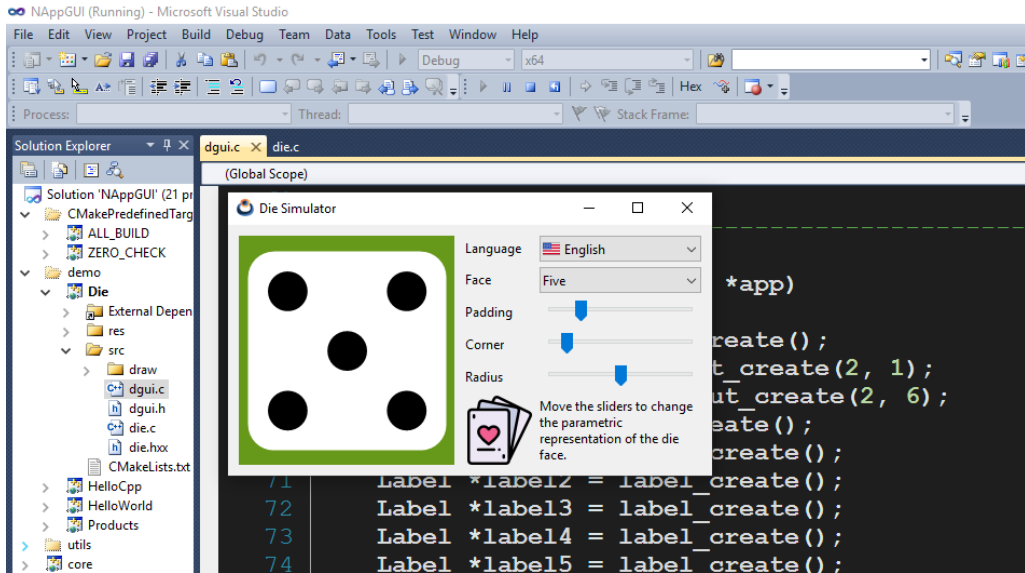

Figure 11.3: Debugging application *Die* in Visual Studio 2010.

```
cmake --build build --config Release -j 4
```

11.4.1. Platform toolset

Starting with Visual Studio 2010, there is a decoupling between the editor and the compiler. The term *Platform Toolset* identifies the compiler itself, which can continue to be used with more modern IDEs. If we do not specify anything, CMake will use the default toolset included in each version of VS, but it can be changed using the `-T` parameter of CMake (Table 11.2). For example, we can combine Visual Studio 15 2017 with the VS2013 toolset for Windows XP `v120_xp`:

```
cmake -G "Visual Studio 15 2017" -A Win32 -T v120_xp -S . -B build
```

Toolset (-T)	VS version
v143	Visual Studio 2022
v142	Visual Studio 2019
v141	Visual Studio 2017
v141_xp	Visual Studio 2017 (with XP support)
v140	Visual Studio 2015

Toolset (-T)	VS version
v140_xp	Visual Studio 2015 (with XP support)
v120	Visual Studio 2013
v120_xp	Visual Studio 2013 (with XP support)
v110	Visual Studio 2012
v110_xp	Visual Studio 2012 (with XP support)
v100	Visual Studio 2010
v90	Visual Studio 2008
v80	Visual Studio 2005

Table 11.2: Toolset included in every version of VS.

*You need to have each version of Visual Studio installed to use its toolset. There are “light” versions that install the **build tools** without the development environment.*

11.4.2. Visual C++ Redistributable

By default, Visual Studio dynamically links the functions of the C standard library, which means that the .exe may not work on machines that do not have the VC++ DLLs (Figure 11.4). This forces applications to include a copy of MSVCRT.dll, VCRUNTIME.dll, ... or to install the famous *Visual C++ Redistributable* packages. to ensure that the application can run smoothly.

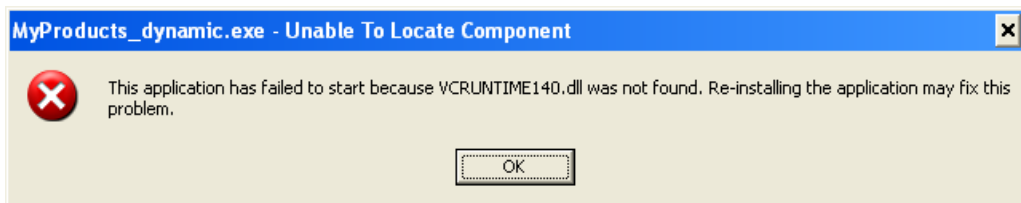

Figure 11.4: Error due to missing VC++ .dll.

NAppGUI uses a reduced set of the C library, since it directly accesses the Windows API whenever possible. For this reason, all applications created with NAppGUI perform a static link (option /MT) of the necessary functions of the stdlib, avoiding dependencies at the cost of slightly increasing (a few Kb) the size of the executable. final. This ensures that applications will run smoothly on all Windows machines without the need for additional DLLs and without having to install the *VC++ Redistributable*.

NAppGUI applications do not require the Visual C++ Redistributable. They also do not use the MFC “Microsoft Foundation Classes” or the .NET platform.

11.4.3. WindowsXP support

Starting with VS2012, the *Platform Toolset* generates executables that are not compatible with WindowsXP. If we want our applications to run on this system, we must select the alternative toolset ending in `_xp`: `v141_xp`, `v140_xp`, `v120_xp`, `v110_xp`. Or `v100`, `v90` or `v80` (VS2010, 2008, 2005), which do directly support XP (Figure 11.5) .

WindowsXP support has been permanently removed in Visual Studio 2019. There is no Platform Toolset v142_xp.

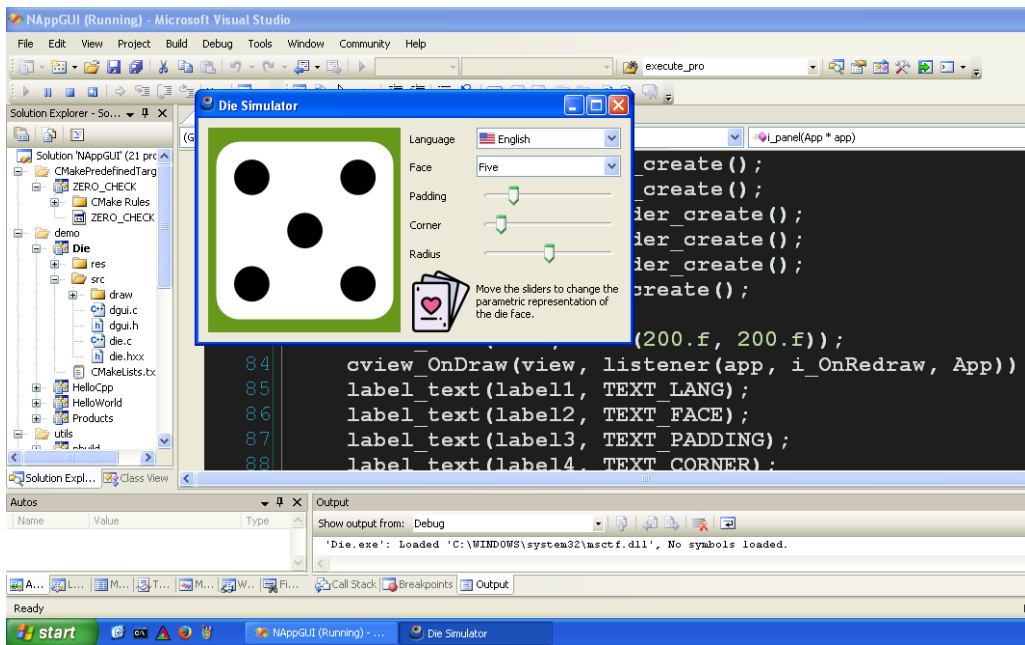

Figure 11.5: Debugging application *Die* on WindowsXP with VS2005 (toolset v80).

Cannot create applications with NAppGUI that work on Windows prior to XP.

11.4.4. SSE support

With the Pentium III, Intel introduced an additional instruction set for floating point operations called *SSE Streaming SIMD Extensions*. This allows you to optimize mathematical calculations at the cost of losing compatibility, since applications that use SSE will not work on Pentium II or earlier models. In NAppGUI the `v80_x86` and `v90_x86`

toolsets have been reserved for building applications compatible with older (Table 11.3) processors. Starting with `v100_x86`, SSE2 will be used in all toolsets.

Toolset	SSE	Minimum CPU
<code>v80_x86</code>	x87 (no SSE)	Pentium II/AMD K6
<code>v90_x86</code>	SSE	Pentium III/AMD Duron
<code>v100_x86</code>	SSE2	Pentium IV/AMD Sempron
<code>v110_x86</code>	SSE2	Pentium IV/AMD Sempron
...	SSE2	...

Table 11.3: SSE support

SSE support is only disabled on 32-bit (x86) architectures. All 64-bit (x64) CPUs incorporate SSE2.

11.5. MinGW

MinGW-w64 is a project created to support GCC/Clang compilers on Windows systems. It forked in 2007 from the original `mingw.org`. In addition to the compilers, it provides Win32 headers and libraries, allowing you to create native Windows applications, without having to install VisualStudio. Starting with version 1.4.2, NAppGUI provides support for this environment.

11.5.1. MinGW-GCC

To compile NAppGUI with MinGW-GCC (Table 11.4) we will:

```
cmake -G "MinGW Makefiles" -S . -B build -DCMAKE_C_COMPILER=gcc -
  ↪ DCMAKE_CXX_COMPILER=g++ -DCMAKE_BUILD_TYPE=Release
cmake --build build -j 4
```

- `-DCMAKE_BUILD_TYPE=[Debug|Release]`: Unlike VisualStudio, MinGW is based on the make tool which is mono-configuration. We must indicate it at generation time and not at compilation time.

	Compiler	Platform	Minimum O.S.
	MinGW-GCC 13	<code>mwgcc13_2_0_x64</code>	Vista

Table 11.4: MinGW-GCC support in NAppGUI.

Since IDE projects are not generated, we recommend using **Visual Studio Code** or **Eclipse CDT** to debug projects generated with MinGW.

11.5.2. MinGW-Clang

If we want to use the Clang compiler (Table 11.5) instead of GCC:

```
cmake -G "MinGW Makefiles" -S . -B build -DCMAKE_C_COMPILER=clang -
↪ DCMAKE_CXX_COMPILER=clang++ -DCMAKE_BUILD_TYPE=Release
cmake --build build -j 4
```

	Compiler	Platform	Minimum O.S.
	MinGW-Clang 18	mwclang18_1_4_x64	Vista

Table 11.5: Support MinGW-Clang in NAppGUI.

11.5.3. MSYS2

Although there are different ways to install MinGW, the most direct, updated and recommended is to do it through an MSYS2 console. This project recreates a Unix terminal on Windows, providing the typical tools (`grep`, `sed`, `curl`, ...) and commands (`ls`, `cp`, `rm`, `cat`, ...). MSYS2 also includes the `pacman` package manager.

- Download MSYS2 from <https://www.msys2.org/>¹. The typical installation is in `C:\msys64`.
- Open an MSYS2 terminal (Figure 11.6) and type:

```
# GCC install
pacman -S --needed base-devel mingw-w64-ucrt-x86_64-toolchain

# Clang install
pacman -S mingw-w64-x86_64-clang
```

- Edit the Windows environment variables by adding these paths to `PATH`:

```
C:\msys64\mingw64\bin
C:\msys64\ucrt64\bin
```

- Open a CMD terminal and check that the compilers work:

```
C:\>gcc --version
gcc (Rev6, Built by MSYS2 project) 13.2.0

C:\>clang --version
```

¹<https://www.msys2.org/>

```

mingw-w64-ucrt-x86_64-libtre-git-r177.07e66d0-2 mingw-w64-ucrt-x86_64-mpc-1.3.1-2
mingw-w64-ucrt-x86_64-mpdecimal-4.0.0-1 mingw-w64-ucrt-x86_64-mpfr-4.2.1-2
mingw-w64-ucrt-x86_64-neurus6-6.4.20231217-1 mingw-w64-ucrt-x86_64-openssl-3.3.0-2
mingw-w64-ucrt-x86_64-python-3.11.9-1 mingw-w64-ucrt-x86_64-readline-8.2.010-1
mingw-w64-ucrt-x86_64-sqlite3-3.45.2-1 mingw-w64-ucrt-x86_64-tcl-8.6.13-1
mingw-w64-ucrt-x86_64-termincap-1.3.1-7 mingw-w64-ucrt-x86_64-tk-8.6.13-1
mingw-w64-ucrt-x86_64-tzdata-2024a-1
mingw-w64-ucrt-x86_64-windows-default-manifest-6.4-4
mingw-w64-ucrt-x86_64-xxhash-0.8.2-2 mingw-w64-ucrt-x86_64-xz-5.6.1-2
mingw-w64-ucrt-x86_64-zlib-1.3.1-1 mingw-w64-ucrt-x86_64-zstd-1.5.6-2 patch-2.7.6-2
pkgconf-2.1.1-1 texinfo-7.1-2 texinfo-tex-7.1-2 base-devel-2022.12-2
mingw-w64-ucrt-x86_64-binutils-2.42-2
mingw-w64-ucrt-x86_64-crt-git-11.0.0.r731.g8fd7c9b5-1
mingw-w64-ucrt-x86_64-gcc-13.2.0-6 mingw-w64-ucrt-x86_64-gdb-14.2-1
mingw-w64-ucrt-x86_64-gdb-multiarch-14.2-1
mingw-w64-ucrt-x86_64-headers-git-11.0.0.r731.g8fd7c9b5-1
mingw-w64-ucrt-x86_64-libmangle-git-11.0.0.r731.g8fd7c9b5-1
mingw-w64-ucrt-x86_64-libwinpthread-git-11.0.0.r731.g8fd7c9b5-1
mingw-w64-ucrt-x86_64-make-4.4.1-2 mingw-w64-ucrt-x86_64-pkgconf-1-2.2.0-1
mingw-w64-ucrt-x86_64-tools-git-11.0.0.r731.g8fd7c9b5-1
mingw-w64-ucrt-x86_64-winpthreads-git-11.0.0.r731.g8fd7c9b5-1
mingw-w64-ucrt-x86_64-winstorecompat-git-11.0.0.r731.g8fd7c9b5-1

Total Download Size: 116.38 MiB
Total Installed Size: 895.68 MiB

:: Proceed with installation? [Y/n]

```

Figure 11.6: Installing GCC using MSYS2.

```

clang version 18.1.4

C:\>mingw32-make -version
GNU Make 4.4.1

```

Lastly, you may want to compile via the MSYS2 console instead of Windows CMD. Then:

```

# GCC compiler under MSYS
cmake -G "MSYS Makefiles" -S . -B build -DCMAKE_C_COMPILER=gcc -
    ↪ DCMAKE_CXX_COMPILER=g++ -DCMAKE_BUILD_TYPE=Release

# Clang compiler under MSYS
cmake -G "MSYS Makefiles" -S . -B build -DCMAKE_C_COMPILER=clang -
    ↪ DCMAKE_CXX_COMPILER=clang++ -DCMAKE_BUILD_TYPE=Release

# Build
cmake --build build -j 4

```

Both MinGW and MSYS use the same native Windows versions of GCC and Clang. The difference between both generators lies in the utilities that orchestrate the compilation: Windows-like (MinGW) and Unix-like (MSYS).

11.6. Xcode

To compile for Apple iMac, MacBook and MacMini we will need CMake and Xcode² starting with version 3.2.6 (Table 11.6). NAppGUI allows you to build applications that work on MacOSX 10.6 Snow Leopard and later:

²<https://developer.apple.com/xcode/>















	Compiler	Minimum O.S.	Platform
	Xcode 15.0.1	Sonoma	sdk14_0_x64 (arm)
	Xcode 14.3.1	Ventura	sdk13_6_x64 (arm)
	Xcode 13.4.1	Monterey	sdk12_3_x64 (arm)
	Xcode 12.5.1	Big Sur	sdk11_5_x64 (arm)
	Xcode 11.7	Catalina	sdk10_15_x64
	Xcode 10.3	Mojave	sdk10_14_x64
	Xcode 9.4.1	High Sierra	sdk10_13_x64
	Xcode 8.3.3	Sierra	sdk10_12_x64
	Xcode 7.3.1	El Capitan	sdk10_11_x64
	Xcode 6.4	Yosemite	sdk10_10_x64
	Xcode 6.2	Mavericks	sdk10_9_x64
	Xcode 5.1.1	Mountain Lion	sdk10_8_x64
	Xcode 4.6.3	Lion	sdk10_7_x64
	Xcode 3.2.6	Snow Leopard	sdk10_6_x64 (x86)

Table 11.6: Xcode versions supported by NAppGUI.

```
cmake -G Xcode -DCMAKE_OSX_DEPLOYMENT_TARGET=11.0 -DCMAKE_ARCHITECTURE=arm64 -S
↳ . -B build
```

- -G always Xcode. Use `xcode-select` to toggle if you have multiple versions installed.
- -DCMAKE_OSX_DEPLOYMENT_TARGET. Minimum operating system that will be supported. Omitting it will set the **Base SDK** included in the Xcode version.

```
-DCMAKE_OSX_DEPLOYMENT_TARGET=14.0 // Sonoma
-DCMAKE_OSX_DEPLOYMENT_TARGET=13.6 // Ventura
-DCMAKE_OSX_DEPLOYMENT_TARGET=13.5 // Ventura
-DCMAKE_OSX_DEPLOYMENT_TARGET=13.4 // Ventura
-DCMAKE_OSX_DEPLOYMENT_TARGET=13.3 // Ventura
-DCMAKE_OSX_DEPLOYMENT_TARGET=13.2 // Ventura
-DCMAKE_OSX_DEPLOYMENT_TARGET=13.1 // Ventura
-DCMAKE_OSX_DEPLOYMENT_TARGET=13.0 // Ventura
-DCMAKE_OSX_DEPLOYMENT_TARGET=12.4 // Monterey
-DCMAKE_OSX_DEPLOYMENT_TARGET=12.3 // Monterey
-DCMAKE_OSX_DEPLOYMENT_TARGET=12.2 // Monterey
```

```

-DCMAKE_OSX_DEPLOYMENT_TARGET=12.0 // Monterey
-DCMAKE_OSX_DEPLOYMENT_TARGET=11.5 // Big Sur
-DCMAKE_OSX_DEPLOYMENT_TARGET=11.4 // Big Sur
-DCMAKE_OSX_DEPLOYMENT_TARGET=11.3 // Big Sur
-DCMAKE_OSX_DEPLOYMENT_TARGET=11.2 // Big Sur
-DCMAKE_OSX_DEPLOYMENT_TARGET=11.1 // Big Sur
-DCMAKE_OSX_DEPLOYMENT_TARGET=11.0 // Big Sur
-DCMAKE_OSX_DEPLOYMENT_TARGET=10.15 // Catalina
-DCMAKE_OSX_DEPLOYMENT_TARGET=10.14 // Mojave
-DCMAKE_OSX_DEPLOYMENT_TARGET=10.13 // High Sierra
-DCMAKE_OSX_DEPLOYMENT_TARGET=10.12 // Sierra
-DCMAKE_OSX_DEPLOYMENT_TARGET=10.11 // El Capitan
-DCMAKE_OSX_DEPLOYMENT_TARGET=10.10 // Yosemite
-DCMAKE_OSX_DEPLOYMENT_TARGET=10.9 // Mavericks
-DCMAKE_OSX_DEPLOYMENT_TARGET=10.8 // Mountain Lion
-DCMAKE_OSX_DEPLOYMENT_TARGET=10.7 // Lion
-DCMAKE_OSX_DEPLOYMENT_TARGET=10.6 // Snow Leopard

```

- `-DCMAKE_ARCHITECTURE`. `arm64`, `x64`, `i386`. The `arm64` architecture is included starting with SDK 11.0 Big Sur. `i386` was deprecated in macOS 10.13 High Sierra.

```

-DCMAKE_ARCHITECTURE=arm64
-DCMAKE_ARCHITECTURE=x64
-DCMAKE_ARCHITECTURE=i386

```

NAppGUI does not support the creation of Apple's Fat binaries. You must indicate a single value in this field.

- `-s`: Path where the `CMakeLists.txt` is located.
- `-B`: Path where the build projects, binaries and temporary files will be generated.
- `-DNAPPGUI_DEMO=NO`: Avoid generating the example applications. Only the SDK will be compiled.

After running CMake, an Xcode solution will appear in the `/build` folder, `NAppGUI.xcodeproj` or whatever name is configured in `project(NAppGUI)` of the `CMakeLists.txt`. Opening the Xcode solution, we see the different projects that make it up, including *Die* and *Dice*. Select *Die* in the top left dropdown and then click `Play` or `Product->Run` (Figure 11.7). This will compile the program and launch it in debug mode, where we can set breakpoints to inspect the stack and the values of the variables.

11.6.1. Base SDK and Deployment Target

Every year, Apple releases a new version of macOS, accompanied by a new SDK and an update to Xcode that includes the SDK. This is called the **Base SDK**.

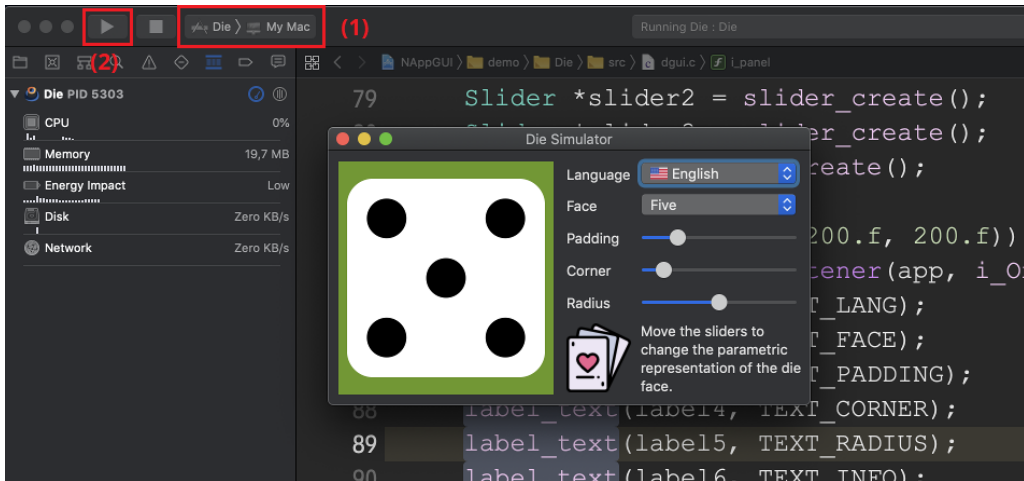

Figure 11.7: Debugging application *Die* in Xcode.

Base SDK is the version included in each new major version of Xcode, which matches the latest version of the macOS system released on the market.

Apple has a much more restrictive policy than Microsoft regarding the compatibility of applications with previous versions of the operating system. By default, a program compiled with SDK 10.14 (macOS Mojave) will not work on the immediately preceding macOS High Sierra (Figure 11.8).

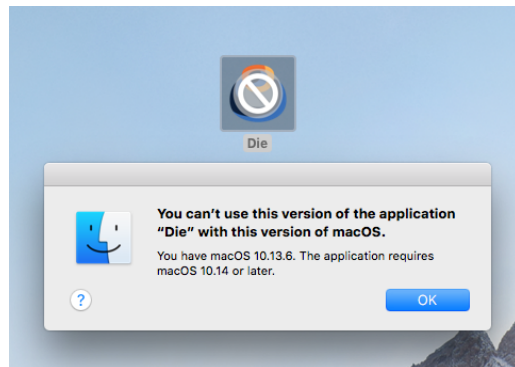

Figure 11.8: *Die* with *Base SDK* 10.14 will not work on High Sierra.

To avoid this problem, and for applications to work on older macOS, there is the **Deployment Target** parameter. Using it will trigger a macro that will override the new features of the Base SDK. This will allow the program to run on older versions at the cost, of course, of not having access to the latest iMac features. You will be able to select the Deployment Target required by your project through the `-DCMAKE_OSX_DEPLOYMENT_TARGET` parameter, as we have already seen in the previous section.

Xcode 14 deprecates Deployment Targets below 10.13 (Figure 11.9). Use Xcode 13 if you want compatibility with Mac OS X 10.12 Sierra and earlier.

Figure 11.9: Deployment Target 10.12 deprecated as of Xcode 14.



Xcode 8 deprecates Deployment Targets below 10.9 (Figure 11.10). Use Xcode 7 if you want compatibility with Mac OS X 10.8 Mountain Lion and earlier.

Figure 11.10: Deployment Target 10.8 deprecated as of Xcode 8.

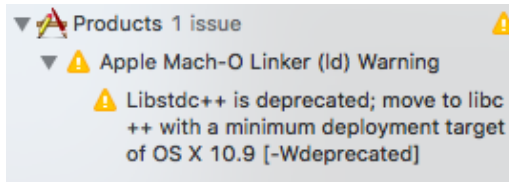

11.6.2. xcode-select

We have already seen that CMake only offers one generator for Xcode (`-G "Xcode"`), although it is possible to have multiple versions installed on the same machine, each within its own *bundle* `xcode.app`. There will always be a default Xcode on the system (the most recent one) but it can be changed using the `xcode-select` utility:

Query the current version of Xcode.

```
xcode-select -p
/Applications/Xcode.app/Contents/Developer
```

Changing the active version of Xcode.

```
sudo xcode-select -s /Applications/Xcode8.app/Contents/Developer
```

Set the default version of Xcode.

```
sudo xcode-select -r
```

You will need to run `cmake -G "Xcode"...` again each time you use `xcode-select` for your project to update the compiler change.

11.6.3. macOS ARM

In November 2020 Apple launches its new line of desktop and laptop computers (iMac, MacBook and MacMini) based on the Apple M1 processor with ARM (Figure 11.11) architecture. Although they are capable of running programs compiled for Intel x64 using

the Rosetta 2 (Figure 11.12) program, the ideal would be to compile our applications for the new architecture in order to optimize the executables as much as possible.



Figure 11.11: Procesadores M1 de Apple.

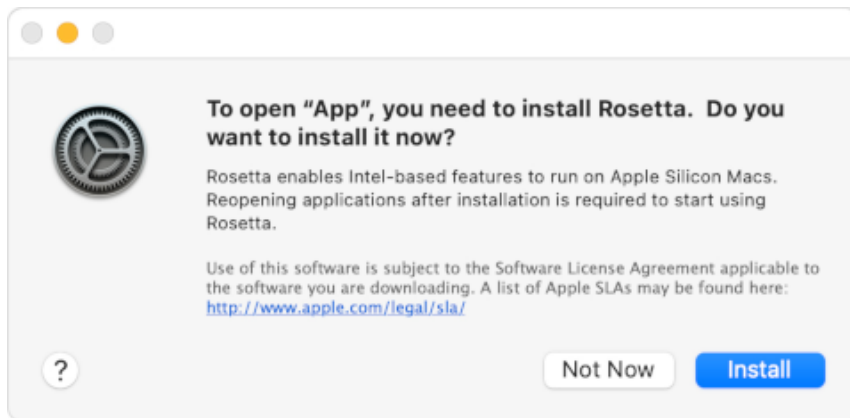

Figure 11.12: Warning Rosetta 2 when trying to run x64 code on an Apple M1.

NAppGUI supports building for the Apple ARM architecture. You just need to include the `-DCMAKE_ARCHITECTURE=arm64` option in CMake, as we saw in the previous section.

You can compile the M1 architecture from Intel x64 machines, but you won't be able to debug the executables.

M1 architecture is only available for Big Sur system (macOS 11.0) and later.

11.6.4. macOS 32bits

Since the macOS High Sierra release, Apple has declared the 32-bit architecture obsolete³, issuing notices to users in the case of detecting i386 (Figure 11.13) executables. As of Xcode 10, (Figure 11.14) cannot be compiled on this architecture.

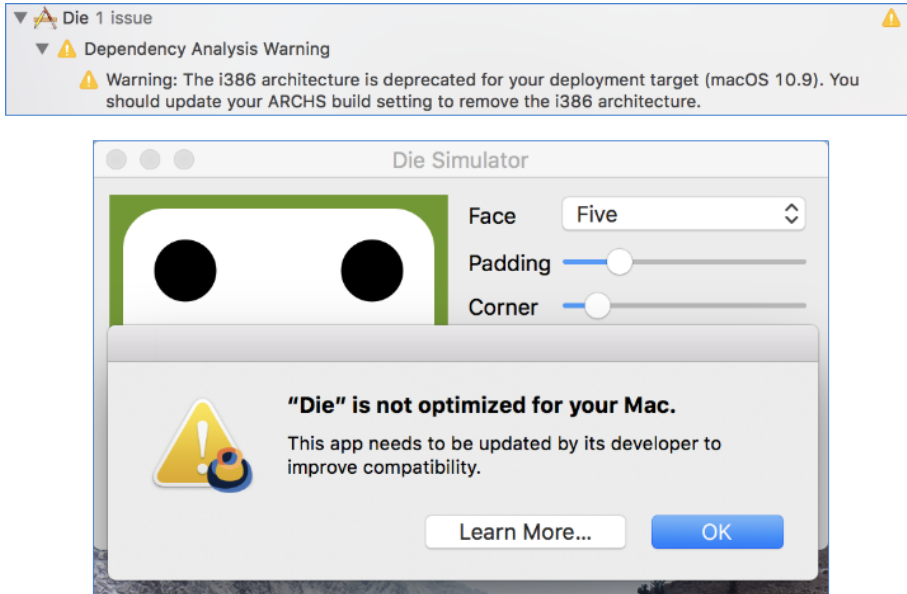

Figure 11.13: macOS warnings in 32bit applications.

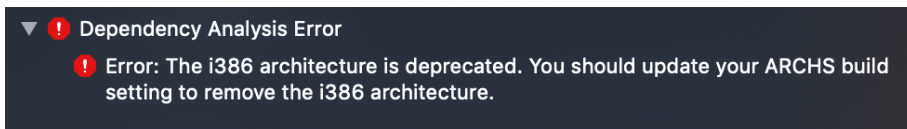

Figure 11.14: Xcode 10 error when trying to compile in 32bit.

*Support for 32bit applications is gone for good in **macOS Catalina**, which only allows running 64bit applications.*

This makes some sense since all Intel-based iMac models feature 64-bit processors, except for a few 2006 models in white polycarbonate that mounted the 32-bit Intel Core Duo (Figure 11.15) . These iMacs supported Mac OSX 10.6 Snow Leopard at most, with a 64-bit CPU being a fundamental requirement as of 10.7 Lion. To compile without problems in 32bits you must use, at most, Xcode 6 (Figure 11.16).

³<https://support.apple.com/en-us/HT208436>



Figure 11.15: Only Apple models with Intel 32bit processor.

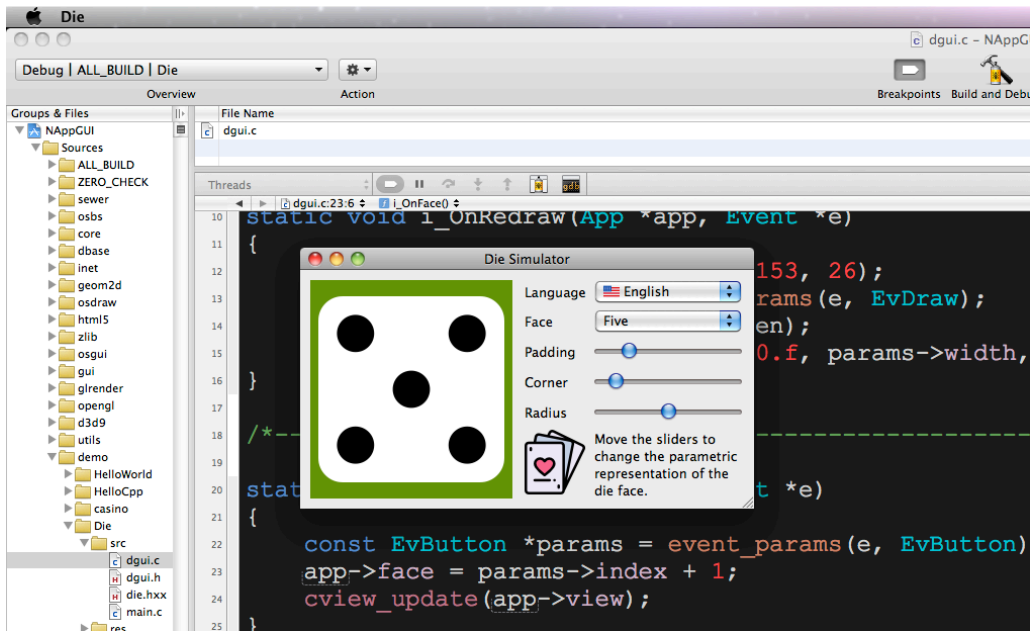

Figure 11.16: 32-bit compilation with Xcode 3.2.6 (Snow Leopard).

11.7. macOS Make

The Unix Make utility is included as part of the Xcode build tools. Therefore, we can use it as a generator on macOS, if we can do without the Xcode projects. Make is mono-configuration, so we must indicate the configuration type during generation.

```
cmake -G "Unix Makefiles" -S . -B build -DNAPPGUI_DEMO=NO -DCMAKE_BUILD_TYPE=
  ↪ Release
cmake --build build
```

11.8. Linux GCC

For Linux versions, we will use the `gcc` (Table 11.7) compiler and the `make` tool to generate the binaries, but there is no “official” development environment as it happens in Windows and macOS. To carry out an elementary configuration of our equipment, type the following commands in a terminal:











```
// Development tools
sudo apt-get install build-essential
sudo apt-get install git
sudo apt-get install cmake

// Development libraries
sudo apt-get install libgtk-3-dev
sudo apt-get install libglul-mesa-dev freeglut3-dev mesa-common-dev
sudo apt-get install libcurl4-openssl-dev

// GTK Inspector (Ctrl+D when debugging)
gsettings set org.gtk.Settings.Debug enable-inspector-keybinding true

// Check system libraries version
pkg-config --modversion gtk+-3.0
3.24.20

pkg-config --modversion libcurl
7.68.0
```

	Minimum O.S.	Compiler	Toolkit	Platform
	Ubuntu 24.04 LTS	GCC 13.2.0	GTK 3.24.41	gcc13_2_0_gtk3_x64
	Ubuntu 22.04 LTS	GCC 11.2.0	GTK 3.24.33	gcc11_2_0_gtk3_x64
	Ubuntu 20.04 LTS	GCC 9.4.0	GTK 3.24.20	gcc9_4_0_gtk3_x64
	Ubuntu 18.04 LTS	GCC 7.5.0	GTK 3.22.30	gcc7_5_0_gtk3_x64
	Ubuntu 16.04 LTS	GCC 5.4.0	GTK 3.18.9	gcc5_4_0_gtk3_x64 (x86)
	Ubuntu 14.04 LTS	GCC 4.8.4	GTK 3.10.8	gcc4_8_4_gtk3_x64 (x86)
	Ubuntu 12.04 LTS	GCC 4.6.3	GTK 3.4.2	gcc4_6_3_gtk3_x64 (x86)
	Raspbian 11 Bullseye	GCC 10.2.1	GTK 3.24.24	gcc10_gtk3_arm64
	Raspbian 10 Buster	GCC 8.3.0	GTK 3.24.5	gcc8_gtk3_arm
	Raspbian 9.1 Stretch	GCC 6.3.0	GTK 3.22.11	gcc6_gtk3_arm
	Raspbian 8.0 Jessie	GCC 4.9.2	GTK 3.14.5	gcc4_9_gtk3_arm

	Minimum O.S.	Compiler	Toolkit	Platform
--	--------------	----------	---------	----------

Table 11.7: GCC versions supported by NAppGUI.

Just like we did on Windows and macOS, we run `cmake` to generate the build project:

```
cmake -G "Unix Makefiles" -DCMAKE_C_COMPILER=gcc -DCMAKE_CXX_COMPILER=g++ -
  ↪ DCMAKE_BUILD_TYPE=Debug -DCMAKE_ARCHITECTURE=x64 -DCMAKE_TOOLKIT=GTK3 -S
  ↪ . -B build
```

- `-G` always "Unix Makefiles". Additionally, you can create projects for the main IDEs available in Linux:

```
-G "Unix Makefiles"
-G "CodeBlocks - Unix Makefiles"
-G "CodeLite - Unix Makefiles"
-G "Sublime Text 2 - Unix Makefiles"
-G "Kate - Unix Makefiles"
-G "Eclipse CDT4 - Unix Makefiles"
```

- `DCMAKE_C_COMPILER`. C compiler. By default, `gcc`.
- `DCMAKE_CXX_COMPILER`. C++ compiler. Default, `g++`.
- `-DCMAKE_BUILD_TYPE`. Unlike Visual Studio and Xcode, Make does not allow the creation of multi-configuration projects. It must be indicated at the time of generation:

```
-DCMAKE_BUILD_TYPE=Debug
-DCMAKE_BUILD_TYPE=Release
-DCMAKE_BUILD_TYPE=ReleaseWithAssert
```

- `-DCMAKE_ARCHITECTURE`. `x64`, `i386`, `arm`, `arm64`. Cross-compiling is not allowed on Linux. We must select the same architecture as the host machine. This parameter can be omitted, it will be set automatically.

```
-DCMAKE_ARCHITECTURE=x64 // Only in Linux Intel 64bits hosts
-DCMAKE_ARCHITECTURE=i386 // Only in Linux Intel 32bits hosts
-DCMAKE_ARCHITECTURE=arm // Only in Linux ARM 32bits hosts
-DCMAKE_ARCHITECTURE=arm64 // Only in Linux ARM 64bits hosts
```

- `-DCMAKE_TOOLKIT`. As of today, the only option available is `GTK3`, since NAppGUI does not support other graphical toolkits. This parameter can be omitted, it will be set automatically.

```
-DCMAKE_TOOLKIT=GTK3
```

- `-S`: Path where the `CMakeLists.txt` is located.

- `-B`: Path where the build projects, binaries and temporary files will be generated.
- `-DNAPPGUI_DEMO=NO`: Avoid generating the example applications. Only the SDK will be compiled.

After executing `cmake` we will have, in the `/build` folder, a series of Makefiles ready to compile the project.

```
cmake --build build -j 4

...
[ 93%] Linking CXX executable ../../Debug/bin/DrawBig
[ 93%] Linking CXX executable ../../Debug/bin/GuiHello
[ 93%] Built target DrawBig
[ 94%] Building C object howto/drawhello/CMakeFiles/DrawHello.dir/resgen/
↳ res_drawhello.c.o
[ 94%] Linking CXX executable ../../Debug/bin/Col2dHello
[ 98%] Built target GuiHello
[ 98%] Building C object howto/drawing/CMakeFiles/DrawImg.dir/resgen/
↳ res_drawing.c.o
[ 98%] Linking CXX executable ../../Debug/bin/UrlImg
[ 98%] Linking CXX executable ../../Debug/bin/DrawHello
[ 98%] Built target Col2dHello
[ 98%] Linking CXX executable ../../Debug/bin/ColorView
[ 98%] Built target UrlImg
[ 98%] Built target DrawHello
[ 99%] Linking CXX executable ../../Debug/bin/DrawImg
[100%] Built target ColorView
[100%] Built target DrawImg
```

Once the compilation is finished, we can launch the executables directly from the terminal:

Launch application *Die*.

```
./build/demo/die/Debug/Die
```

If you're fairly comfortable with `gdb`, you can try debugging the code directly from the (Figure 11.17) terminal. Later we will see how to do it using Eclipse and Visual Studio Code.

Debugging *Die* with *gdb*

```
gdb ./build/demo/die/Debug/Die
(gdb) run
...
```

To build the example applications, you must ignore the `-DNAPPGUI_DEMO=NO` option in CMake.



Figure 11.17: Debugging *Die* with GDB from the terminal.

11.8.1. Multiple versions of GCC

Although every Linux distribution comes with a “canonical” version of GCC, it is possible to have several installed on the same machine and switch between them much like we did on macOS with `xcode-select`. To do this we will use the Linux `update-alternatives` command. We assume that we are on Ubuntu 18.04 LTS:

Version of gcc installed.

```
gcc --version
gcc 7.5.0
```

Install gcc-6

```
sudo apt-get install gcc-6 g++-6
```

Register gcc-7 and gcc-6

```
sudo update-alternatives --install /usr/bin/gcc gcc /usr/bin/gcc-7 60 --slave /
↳ usr/bin/g++ g++ /usr/bin/g++-7
sudo update-alternatives --install /usr/bin/gcc gcc /usr/bin/gcc-6 50 --slave /
↳ usr/bin/g++ g++ /usr/bin/g++-6
```

Switch to gcc-6.

```
sudo update-alternatives --set gcc /usr/bin/gcc-6
gcc --version
gcc 6.5.0
g++ --version
g++ 6.5.0
```

Return to the default version of gcc.

```
sudo update-alternatives --auto gcc
gcc --version
gcc 7.5.0
g++ --version
g++ 7.5.0
```

11.8.2. Linux 32bits

To compile 32bit applications from a 64bit Ubuntu system it is necessary to install the multilib package:

```
sudo apt-get install gcc-multilib
```

But there are currently problems⁴ with cross-compiling that includes the GTK+ library, so it won't be possible to use the same machine development to build on both architectures, just like it does on Windows. Console applications or libraries that do not access GTK can be compiled in 32bit from a 64bit computer.

It is not possible to compile in 32bits from a 64bit Ubuntu system applications that use GTK+3. You must use a 32-bit Linux system for this.

11.8.3. Linux ARM

The ARM⁵ *Advanced RISC Machine* architecture is the predominant one in the market for embedded devices such as smartphones and tablets. Currently, NAppGUI does not offer support for the development of iOS/Android mobile applications, but it does support other types of boards that support “desktop” versions of Linux ARM, such as the Raspberry Pi. To port our code to the Raspberry Pi we must follow the same steps as in Ubuntu Linux (Figure 11.18). Both distributions are based on Debian, so GCC, CMake and Make are available directly via `apt-get`.

11.9. Linux Clang

GCC is the default compiler that is installed with the `build-essential` package. However, we can use Clang if we prefer (Table 11.8). The first thing is to install the compiler:

```
sudo apt-get install clang
clang --version
clang version 10.0.0-4ubuntu1
```

⁴<https://ubuntuforums.org/showthread.php?t=2038875>

⁵https://en.wikipedia.org/wiki/ARM_architecture

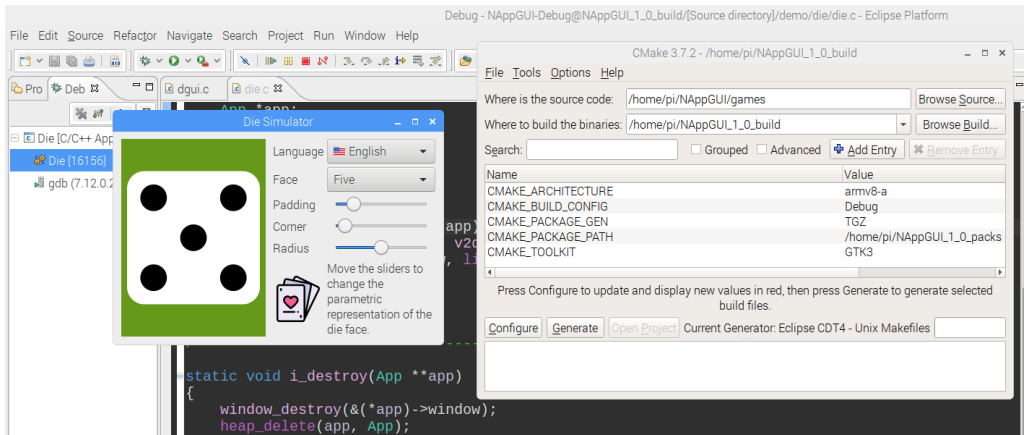

Figure 11.18: Debugging the application *Die* on a Raspberry Pi.







	Minimum O.S.	Compiler	Toolkit	Platform
	Ubuntu 24.04 LTS	Clang 18.1.3	GTK 3.24.41	clang18_1_3_gtk3_x64
	Ubuntu 22.04 LTS	Clang 14.0.0	GTK 3.24.33	clang14_0_0_gtk3_x64
	Ubuntu 20.04 LTS	Clang 10.0.0	GTK 3.24.20	clang10_0_0_gtk3_x64
	Ubuntu 18.04 LTS	Clang 6.0.0	GTK 3.22.30	clang6_0_0_gtk3_x64
	Ubuntu 16.04 LTS	Clang 3.8.0	GTK 3.18.9	clang3_8_0_gtk3_x64 (x86)
	Ubuntu 14.04 LTS	Clang 3.4.0	GTK 3.10.8	clang3_4_0_gtk3_x64 (x86)
	Ubuntu 12.04 LTS	Clang 3.0.0	GTK 3.4.2	clang3_0_0_gtk3_x64 (x86)





Table 11.8: Clang versions supported by NAppGUI.

To use Clang, we just change the name of the compiler when generating the compilation project:

```
cmake -G "Unix Makefiles" -DCMAKE_C_COMPILER=clang -DCMAKE_CXX_COMPILER=clang++
  ↪ -DCMAKE_BUILD_TYPE=Debug -DCMAKE_ARCHITECTURE=x64 -DCMAKE_TOOLKIT=GTK3
  ↪ -S . -B build
```

11.10. Linux GTK

Unlike Windows and macOS, Linux supports a multitude of desktop environments based on different libraries (or *toolkits*), GTK and Qt being the two most famous. NAppGUI uses GTK+3 for the graphical part since it is the base of the Gnome, Xfce, Lxde, etc, (Table 11.9) environments present in many of the most widespread distributions. GTK+3 will be present naturally in all of them, with no other additional dependencies being necessary. Of course, to compile under GTK+3 we will have to install the developer version, as we saw previously.

	Environment	Distributions
	Gnome	Ubuntu, Debian, Fedora, Red Hat, CentOS, Manjaro, Suse, Arch, ...
	Xfce	Xubuntu, Debian, Fedora, Manjaro, ...
	Lxde	Lubuntu, Raspbian, Debian, Fedora, Mandriva, ...
	Cinnamon	Mint, Debian, Ubuntu, Fedora, OpenSuse, ...
	Mate	Ubuntu Mate, Mint, Debian, Fedora, OpenSuse, ...



	Environment	Distributions
	Pantheon	Elementary OS
	Sugar	

Table 11.9: Gtk-based desktop environments.

11.11. Ninja

The Ninja generator allows for faster compilations than Visual Studio, Xcode or Make, in exchange for losing the *.sln, *.vcxproj or *.xcodeproj projects that are very useful for debugging from the IDE. It is usually used in continuous integration systems where speed prevails in favor of versatility.

To install Ninja on Windows, we download it from Ninja⁶, copy `ninja.exe` to any system folder and make it accessible through the `PATH` variable.

```
ninja --version
1.11.1
```

On macOS, we will install it using `brew`:

```
brew install ninja
ninja --version
1.11.1
```

And in Linux from `apt-get`:

```
sudo apt-get install ninja-build
ninja --version
1.10.1
```

Using Ninja is exactly the same as in previous cases. We will only change the name of the generator in CMake.

```
cmake -G Ninja -S . -B build -DCMAKE_C_COMPILER=gcc -DCMAKE_CXX_COMPILER=g++ -
↳ DCMAKE_BUILD_TYPE=Release
cmake --build build
```

We can also use the multi-configuration version of Ninja:

```
cmake -G "Ninja Multi-Config" -S . -B build -DCMAKE_C_COMPILER=gcc -
↳ DCMAKE_CXX_COMPILER=g++ -DCMAKE_BUILD_TYPE=Release
cmake --build build --config Release
```

⁶<https://ninja-build.org/>

CMake supports “Ninja Multi-Config” as of version 3.17.

- `-DCMAKE_C_COMPILER/DCMAKE_CXX_COMPILER`: Ninja will use any C/C++ compiler we have installed. `gcc/g++`, `clang/clang++` or `cl/cl` (MSVC).

On Windows, the `MSVC` compiler, in principle, is not accessible directly from the command line. To make it accessible we have two ways:

- Use the `Developer Command Prompt 2022` console (or whatever version you choose). This terminal knows the location of the build tools.
- Set the environment variables using the script `vcvarsall.bat` [Win32|x64]. A possible location will be `"C:\Program Files\Microsoft Visual Studio\2022\Community\VC\Auxiliary\Build\vcvarsall.bat"`x64, but it will change depending on the version of Visual Studio we have installed.

11.12. Configurations

A `NAppGUI` application can be compiled in three different configurations, depending on the level of debugging we need.

- *Debug*: Includes debugging information in the binaries and does not perform code optimizations. It is the developer version.
- *Release*: Remove debug information and perform all possible optimizations. It is the version for the user.
- *ReleaseWithAssert*: It is the Release version, but leaving the “*Asserts*” (page 159) statements active. It is aimed at the end user, but in cases where it is necessary to obtain detailed information on possible anomalies, at the cost of a decrease in the overall performance of the program.

Both Visual Studio and Xcode are multi-configuration environments, that is, we can switch between one and the other directly from the editor itself. In Visual Studio we have a dropdown at the top of the (Figure 11.19) editor.

In Xcode it is a bit more hidden. We do `Product->Scheme->Edit Scheme`. A popup window will appear. Select `Run->Info->Build Configuration` (Figure 11.20).

Unfortunately, Unix `make` does not support multiple configurations. This forces us to pass the `CMAKE_BUILD_TYPE` (Figure 11.21) to set the configuration in CMake before generating the build scripts.

Mono-configuration generators.

```
cmake -G Ninja -S . -B build DCMAKE_BUILD_TYPE=Release
cmake --build build
```

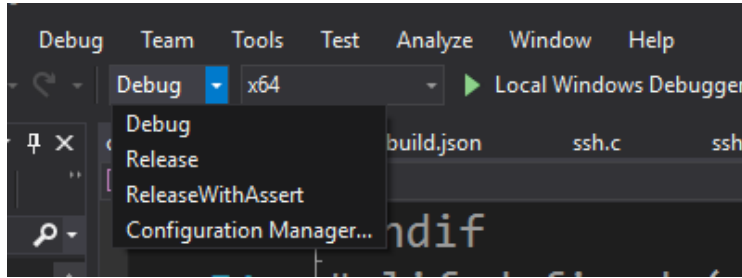

Figure 11.19: Config change in Visual Studio.

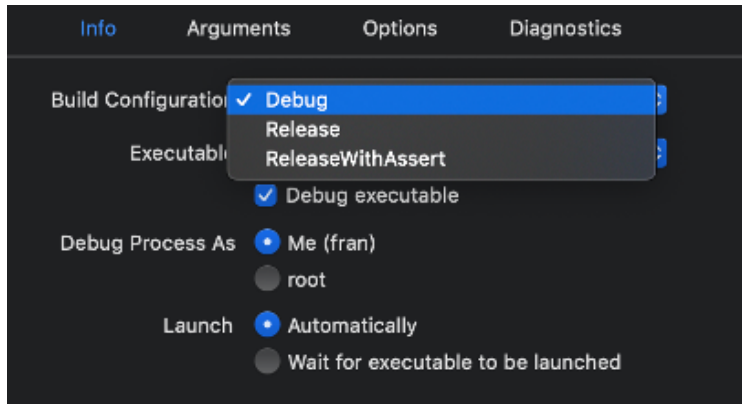

Figure 11.20: Config change in Xcode.

Multi-configuration generators.

```
cmake -G Xcode -S . -B build
cmake --build build --config Release
```

Name	Value
CMAKE_ARCHITECTURE	x64
CMAKE_BUILD_TYPE	Debug
CMAKE_INSTALL_PREFIX	Release
CMAKE_TOOLKIT	ReleaseWithAssert
NAPPGUI_DEMO	
NAPPGUI_SHARED	

Figure 11.21: Change configuration in CMake-GUI (Unix Makefile).

11.13. Eclipse CDT

Generators based on Ninja and Unix Makefiles are terminal-oriented, while those based on Visual Studio and Xcode generate an IDE project. Working directly with the terminal gives us great flexibility when configuring our own tools. Going back to the console and typing `cmake --build build` will recompile everything you need. Now, using GDB directly will be quite tedious, so it will be very useful to have alternative IDEs to debug projects based on these generators. In the development of NAppGUI we use two: **Eclipse CDT** and **Visual Studio Code**.

- Eclipse CDT⁷ is an open source platform composed of a set of C/C++ programming tools available since 2021 on all platforms. To use it we must prepend `Eclipse CDT4` to the name of the generator:

```
-G "Eclipse CDT4 - Unix Makefiles"
-G "Eclipse CDT4 - MinGW Makefiles"
-G "Eclipse CDT4 - Ninja"
```

- In addition to the Makefile, the `.cproject` and `.project` files necessary to import the project into Eclipse will be created.
- Open Eclipse and do `File->Import->Existing Projects into Workspace`. A dialog box will appear where we indicate the *build* directory that we have configured in CMake (`/build`). Eclipse will open the project by placing a tree with all the files on the left.
- To compile `Project->Build All`.
- When debugging (Die in this case) we display the Binaries tree, selecting the executable, right click `Debug As->Local C/C++ Application` (Figure 11.22).

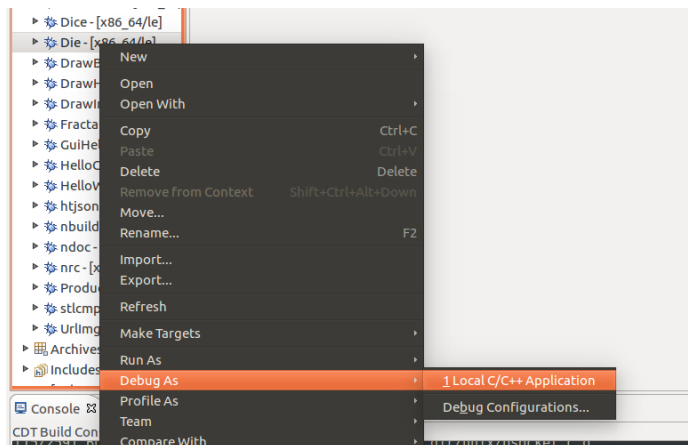

Figure 11.22: Launching an executable to debug in Eclipse.

⁷<https://www.eclipse.org/cdt/>

- Finally we will place the Breakpoints where we are interested and navigate through the code step by step, inspecting variables or the call stack (Figure 11.23).

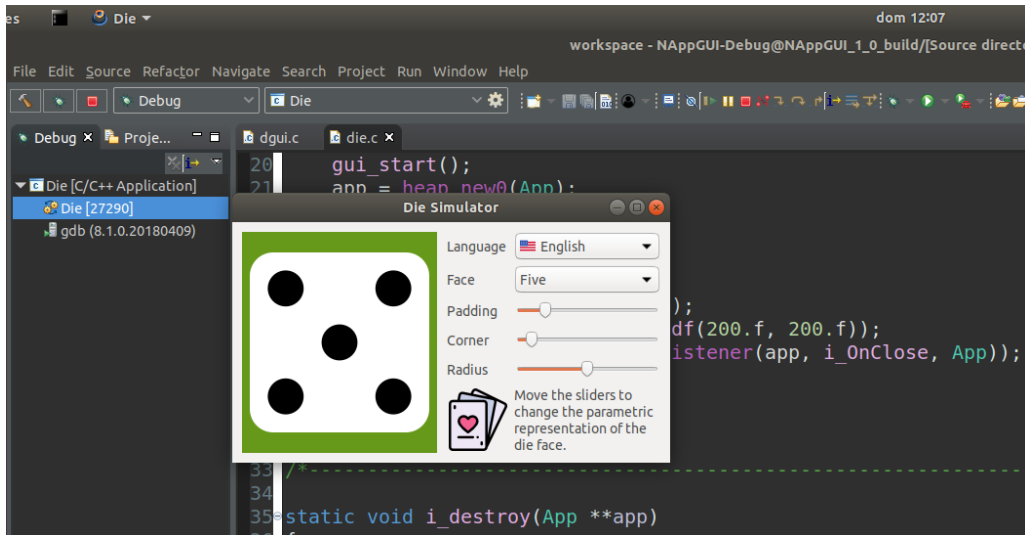

Figure 11.23: Debugging the *Die* application with Eclipse.

Some interesting Eclipse CDT options under `Window->Preferences`.

- `Run/Debug->Launching->Terminate and Relaunch while launching`.

11.14. Visual Studio Code

Another interesting environment to develop and debug is Visual Studio Code⁸. With the appropriate extensions, it is possible to work in C/C++ with CMake in a very comfortable and fluid way. You have installers for all platforms, but it is also available from various package managers, for example `apt-get`:

```
sudo apt-get install code
```

We added, at a minimum, the **C/C++ Extension Pack** which will also include support for CMake (Figure 11.24).

We open our project with `Open Folder`. Later, we run CMake from the environment itself: `[F1]->CMake:Configure`. The first time, VSCode will ask for the location of the `CMakeLists.txt` main (Figure 11.25) (`/src/CMakeLists.txt`).

After the configuration we can compile with `[F1]->CMake:Build`. In the **Output** tab of VSCode we will see the evolution of the process:

⁸<https://code.visualstudio.com/>

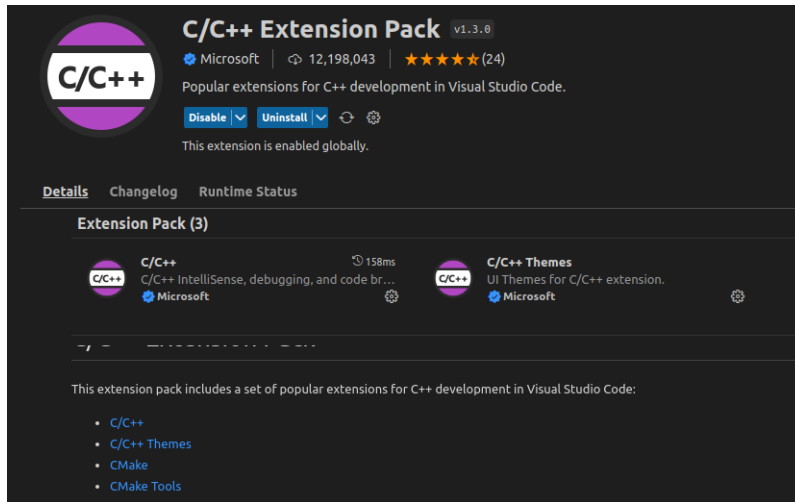

Figure 11.24: C/C++ Extension Pack.

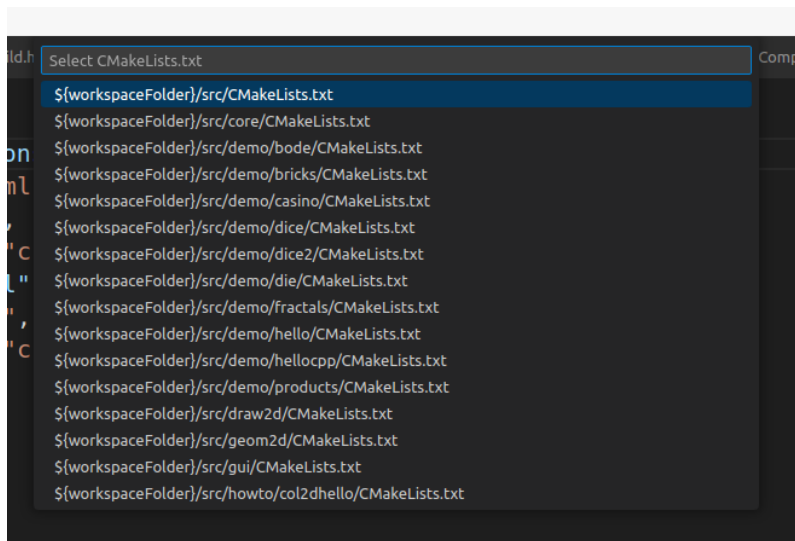

Figure 11.25: Selection of the main CMakeLists.txt of the project.

```
[build] [ 97%] Building C object demo/die/CMakeFiles/Die.dir/resgen/res_die.c.o
[build] [ 98%] Built target Bode
[build] [ 98%] Building C object demo/products/CMakeFiles/Products.dir/products
    ↪ .c.o
[build] [ 98%] Built target Fractals
[build] [ 98%] Building C object demo/products/CMakeFiles/Products.dir/prview.c
    ↪ .o
[build] [ 99%] Linking CXX executable ../../Debug/bin/Die
```

```
[build] [100%] Building C object demo/products/CMakeFiles/Products.dir/resgen/
    ↪ res_products.c.o
[build] [100%] Built target Die
[build] [100%] Linking CXX executable ../../Debug/bin/Products
[build] [100%] Built target Products
```

To debug, the first thing is to select the target (or executable) with [F1]→CMake:Set Debug Target (Figure 11.26).

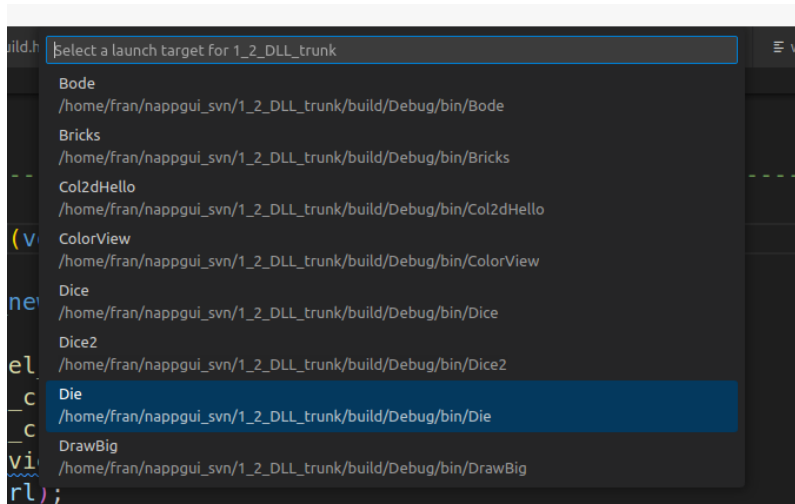

Figure 11.26: Selection of the executable to debug.

And we launch the debugger with [F1]→CMake:Debug (Figure 11.27).

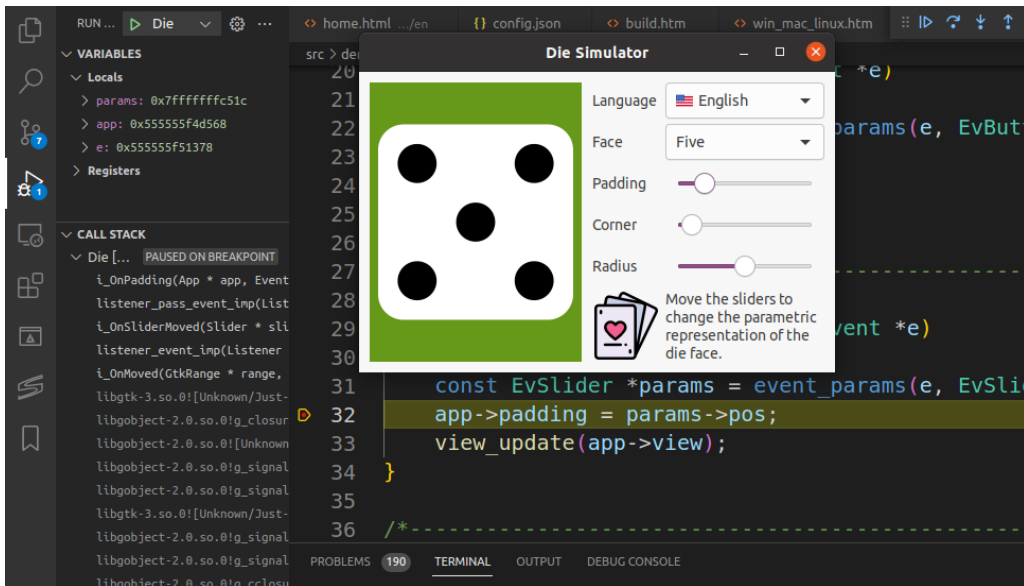

Figure 11.27: Debugging application *Die* from Visual Studio Code.

Part 2

Introduction to the API

NAppGUI SDK



While civilians (i.e., nonprogrammers) often fantasize about winning the lottery, the equivalent for many programmers is the rare opportunity to create a new library from scratch, without the constraints that often frustrate their desires to extend and improve an existing library.

Philip J. Schneider - Industrial Light + Magic

12.1	NAppGUI API	151
12.2	Online resources	153
12.3	A little history	153

12.1. NAppGUI API

The NAppGUI implementation has been split into several libraries written in ANSI-C (C90) with small parts in C++98 (Figure 12.1). The project compiles without problems in all versions of Visual Studio (since VS2005), Xcode (since 3) and GCC (since 4). It can be used for developing high-performance applications written in C on Windows, macOS, and Linux systems. A clear line has been drawn that separates packages oriented to computation and data access (*back-end*) from those intended for the presentation or interface layers (*front-end*). We have also followed certain “Standards” (page 58) whose bases are centralized in the “Sewer” (page 156) library, which, although it does not incorporate much functionality, does define the basic types and configuration macros common to all the project.

-  Packages that do not contain platform dependent code.
-  Packages that contain platform dependent code under a common interface.

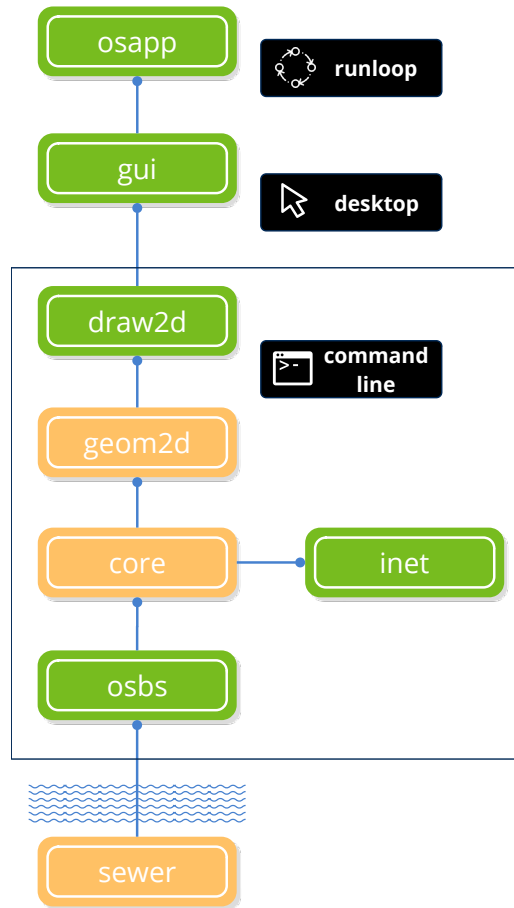

Figure 12.1: NAppGUI architecture.

- “*Sewer*” (page 156): Basic types, assertions, Unicode, standard C library, math functions.
- “*Osbs*” (page 174): Operating system services. Portable API on files, directories, processes, threads, memory, etc.
- “*Core*” (page 195): Commonly used non-graphical utilities. Memory auditor, data structures, I/O channels, lexical analysis, etc.
- “*Geom2D*” (page 243): 2D geometry. Transformations, vectors, polygons, collisions, etc.
- “*Draw2D*” (page 264): Vector drawing API, images and fonts.
- “*Gui*” (page 305): High-level user interface composer.
- “*OSApp*” (page 393): Desktop applications. Message loops.
- “*INet*” (page 401): Internet protocols and services, such as HTTP.

12.2. Online resources

For obvious reasons of space, it is impossible in this book to include a complete reference of each and every one of the functions that make up NAppGUI. On the project's Website¹ you will find a detailed feature-by-feature guide, as well as the source code of several sample applications.

Therefore, please go through this entire section of the book in a leisurely manner, with the sole purpose of getting a general idea of the structure of the software and the different parts that compose it.

12.3. A little history

I started working on this project unconsciously, in the middle of 2008 when I was finishing my studies in Computer Engineering at the University of Alicante. He wanted to develop a physical systems simulator that would work on both PC-Windows computers and Apple iMacs without having to duplicate all the work. The technological alternatives of the time, such as GTK or Qt, did not convince me at all since they were too heavy, complicated to use and slow, so they would end up tarnishing the quality, elegance and effort that I was putting into my mathematical calculation algorithms. After spending several months evaluating different libraries for cross-platform programming, I downloaded some technical manuals from Apple to program directly in Cocoa, the manzanita manufacturer's base technology for developing software on iMac. In the middle of 2010 I started to see the first results and this was encouraging. I had built an application with my simulator prototype in just 500Kb (Figure 12.2), in contrast to the 30+Mb of dependencies required by third-party solutions. The code was compact and clean, the application worked at breakneck speed and, above all, it had a professional appearance that was somewhat reminiscent of iMovie, it allowed 3D views to be manipulated like in a video game and provided technical simulation data in real time. This inspired me to continue working on drawing a barrier between the reusable part of the application and the part that depends on a specific technology. This would allow my simulator to be adapted to different computer models and operating systems.

At the same time, in September 2008 I rejoined the labor market after six years at the University, a market in which I am still currently (May 2021), although the last few years I have been working as a freelancer from home, which allows me to organize the agenda and optimize my time to the maximum. In these years I have not abandoned my personal project, I have continued working on it part-time simply for pure hobby. Its development has allowed me to investigate and delve into interesting areas for me and constantly recycle myself. In 2013 I made my first foray into the world of entrepreneurship as a co-founder of iMech Technologies, a software company with which I am still linked and whose main

¹<https://www.nappgui.com>

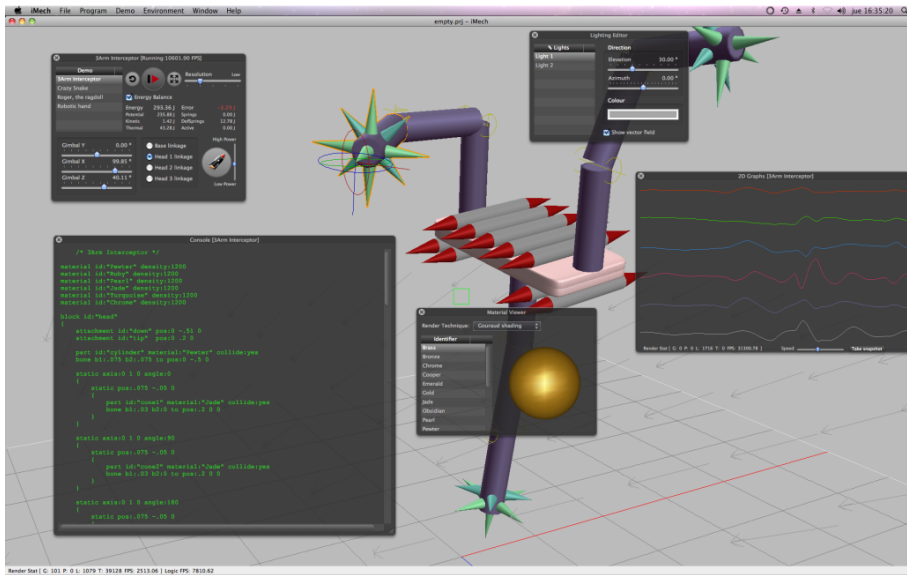

Figure 12.2: iMech simulator, based on a primitive version of NAppGUI.

objective was the sale of the simulation engine that I had previously created. By not coming up with a solid marketing strategy, we didn't achieve our initial goals with iMech, but we were able to turn it around by adding new customers and it's still alive today.

In mid-2015 I began to consider the fact that all the technical effort made during these years has enough entity to become a product by itself. It was then when I created the NAppGUI project and started migrating all the iMech libraries dedicated to cross-platform development. Over the last few years I've completed support for *Cocoa* and included support for *Win32* and *Gtk+*. I have created this documentation in Spanish and English, with the help of Google translation services.

On December 31, 2019, I upload to GitHub the first public pre-compiled version of NAppGUI.

In May 2020 I start the development of the first commercial application programmed entirely with NAppGUI.

On September 8, 2021, I release the source code of NAppGUI on GitHub, making it an Open Source project under the MIT license.

Sewer library

Even the grandest palaces needed sewers.

Tom Lehrer

13.1 Sewer	156
13.1.1 The C standard library	156
13.2 Asserts	159
13.3 Pointers	160
13.4 Unicode	161
13.4.1 UTF encodings	163
13.4.2 UTF-32	163
13.4.3 UTF-16	163
13.4.4 UTF-8	164
13.4.5 Using UTF-8	165
13.5 Maths	166
13.5.1 Random numbers	166
13.6 Standard functions	167
13.6.1 Date conversion	167
13.7 Standard I/O	168
13.8 Memory	169
13.8.1 Stack Segment	169
13.8.2 Heap Segment	170

13.1. Sewer

Sewer is the first library within the NAppGUI SDK (Figure 13.1). It declares the basic types, the Unicode support, assertions, pointers safe manipulation, elementary math functions, Standard I/O and dynamic memory allocation. It is also used as a “sink” to bury the unsightly preprocessor macros necessary to configure the compiler, CPU, platforms, etc. As dependencies only has a few headers of the C standard library:

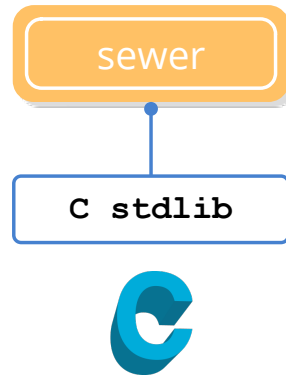

Figure 13.1: Dependencies of *sewer*.
See “NAppGUI API” (page 151).

13.1.1. The C standard library

The C standard library (*cstdlib*) is not part of the C language, but implements functions of great utility for the developer that solve typical programming problems. Any C programmer has used it more or less and its study is usually linked to learning the language itself (Figure 13.2).



Figure 13.2: A complete reference to the C library is found in the P.J.Plauger book.

This library is located halfway between the application and system calls and provides a portable API for file access, dynamic memory, I/O, time, etc (Figure 13.3). It also implements mathematical functions, conversion, search, string management, etc. In one

way or another, NAppGUI integrates its functionality, so it's not necessary (or advisable) to use *cstdlib* directly in the application layer. The reasons that have motivated this design decision can be summarized in:

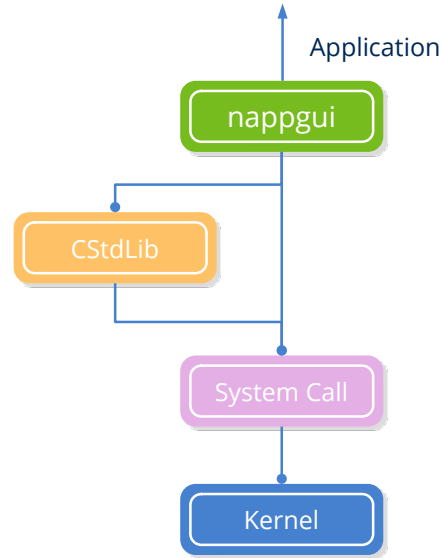

Figure 13.3: The functionality of the C library has been integrated in NAppGUI, avoiding its direct use in applications.

- **Small differences:** Unix-like systems do not support the secure *cstdlib* versions implemented by Microsoft (`strcpy_s()` and others). The use of classical functions (without the suffix `_s`) is insecure and will trigger annoying *warnings* in Visual Studio.
- **Security:** Related to the previous one, avoids *buffer overflow* vulnerabilities in the processing of memory blocks and strings.
- **Duplicity:** Much of the functionality of *cstdlib* is already implemented in *osbs* library using direct system calls (files, dynamic memory, I/O, time, etc.)
- **Completeness:** The *cstdlib* functions related to files (`fopen()` and others) do not include support for directory management. “*Files and directories*” (page 185) presents a complete API based on system calls.
- **Performance:** In certain cases, especially in mathematical functions and memory management, it may be interesting to change the implementation of *cstdlib* to an improved one. All applications will benefit from the change, without having to modify your code.
- **Clarity:** The behavior of some *cstdlib* functions is not entirely clear and can lead to confusion. For example, `strtoul` has a very particular functioning that we must remember every time we use it.

```
char *s1 = "-56";
```

```

char *s2 = "asCr";
char *s3 = "467Xd";
int v1, v2, v3;
v1 = strtoul(s1, NULL, 10); // v1 = 4294967240, errno = OK
v2 = strtoul(s2, NULL, 10); // v2 = 0, errno = OK
v3 = strtoul(s3, NULL, 10); // v3 = 467, errno = OK

```

- **Style:** The use of *sewer* functions does not break the aesthetics of an application written with NAppGUI.

```

real32_t a1 = 1.43f;
real64_t a2 = .38;
real32_t c = (real32_t)cosf((float)a1);
real64_t t = (real64_t)tan((double)a2);
...
real32_t c = bmath_cosf(a1);
real64_t t = bmath_tand(a2);

```

- **Independence:** NAppGUI internally uses a very small subset of *cstdlib* functions. It is possible that in the future we will make our own implementations and completely disconnect the support of the standard library.
- **Static link:** If we statically link the standard library, *sewer* will contain all dependencies internally. This will avoid possible incompatibilities with the runtimes installed on each machine (the classic Windows VC++ Redistributables). With this we will be certain that our executables will work, regardless of the version of the C runtime that exists in each case. If all calls to *cstdlib* are inside *sewer*, we free higher-level libraries from their handling and possible runtime errors related to the C runtime.

Static link of the *cstdlib* in Sewer. Doesn't need the C runtime.

```
RUNTIME_C_LIBRARY "static"
```

```
dumpbin /dependents dsewer.dll
```

Image has the following dependencies:

```
KERNEL32.dll
```

Dynamic binding of the *cstdlib* in Sewer. Needs to have a specific runtime installed.

```
RUNTIME_C_LIBRARY "dynamic"
```

```
dumpbin /dependents dsewer.dll
```

Image has the following dependencies:

```
KERNEL32.dll
```

```
VCRUNTIME140D.dll
ucrtbased.dll
```

To avoid possible bugs or incompatibilities, do not use C Standard Library functions directly in applications. Always look for an equivalent NAppGUI function.

13.2. Asserts

asserts are sentences distributed by the source code that perform an intensive “*Dynamic analysis*” (page 61), helping to detect errors at runtime. When the *assert* condition becomes **FALSE**, the program execution stops and a warning window is displayed (Figure 13.4).

- Use `cassert` to introduce a dynamic check in your code.
- Use `cassert_no_null` once you have to access the content of a pointer.

```
void layout_vmargen(Layout *layout, const uint32_t row, const real32_t
    ↪ margin)
{
    cassert_no_null(layout);
    cassert_msg(row < layout->num_rows, "'row' out of range");
    ...
}
```

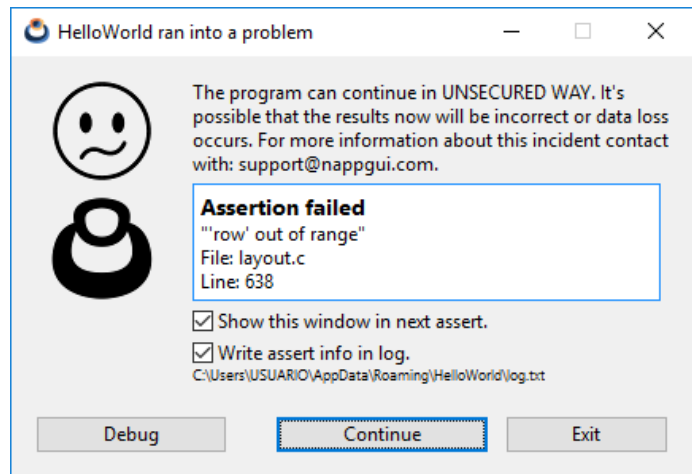

Figure 13.4: *assert* window displayed after a runtime error.

At this time we have three alternatives:

- **Debug:** Debug the program: Access the call stack, inspect variables, etc. More in “*Debugging the program*” (page 63).

- **Continue:** Continue with the execution, ignoring the *assert*.
- **Exit:** Exit the program.

To avoid showing this window in further *asserts*, deactivate the check 'Show this window in next assert'. Future incidents will be directed to a *log* file. You can also omit dumps in this log, deactivating 'Write assert info in log'.

asserts sentences provide very valuable information about program anomalies and should never be ignored.

In the previous example we have seen a “continuable” *assert*, that is, the execution of the program can continue if we press [Continue]. However, as we indicated, they should not be ignored indefinitely. On the other hand we have the **critical asserts** (Figure 13.5). Normally they are related to segment violation problems, where it will not be possible to continue running the program.

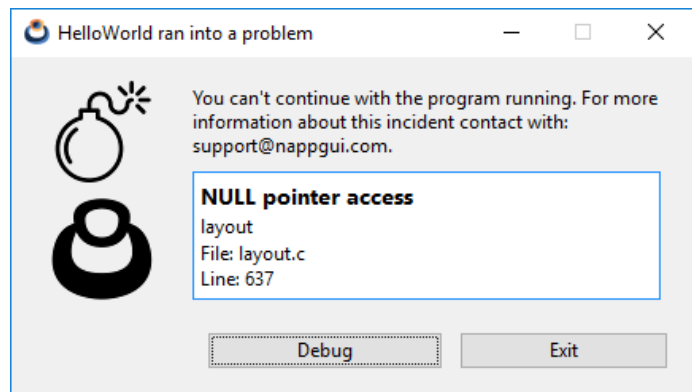

Figure 13.5: Critical *assert* caused by null pointer access.

13.3. Pointers

The *sewer* library provides macros and functions for “safe” pointers manipulation. By “safe” we mean the fact that the SDK will detect improper pointer access just before a *segment violation* occurs. Does it make sense to detect a segment violation if the program is going to crash anyway? Pre-detection plays a very important role when running automated tests. Before the inevitable process closing, it will leave a note in the execution *log.txt*, indicating the reason for the crash.

- Use `ptr_get` to get the content of a pointer.

```
// v2 = NULL
// Segmentation fault
V2Df v1 = *v2;
```

```
// "v2 is NULL in file::line"
// will be record in log.txt
// and then, Segmentation fault
V2Df v1 = ptr_get(v2, V2Df);
```

13.4. Unicode

Unicode is a standard in the computer industry, essentially a table, which assigns a unique number to each symbol of each language in the world (Figure 13.6). These values are usually called *codepoints* and are represented by typing **U+** followed by their number in hexadecimal.

- Use `unicode_convert` to convert a string from one encoding to another.
- Use `unicode_to_u32` to get the first codepoint of a string.

A	U+0041	Latin capital letter A
á	U+00E1	Latin small letter a with acute
Ⓐ	U+04A8	Cyrillic capital letter Abkhasian Ha
𪗇	U+9A17	Ideograph to swindle
π	U+03C0	Greek small letter Pi

Figure 13.6: Several Unicode *codepoints*.

Related to its structure, it has 17 planes of 65536 *codepoints* each (256 blocks of 256 elements) (Figure 13.7). This gives Unicode a theoretical limit of 1114112 characters, of which 136755 have already been occupied (version 10.0 of June 2017). For real-world applications, the most important one is Plane 0 called *Basic Multilingual Plane* (BMP), which includes the symbols of all the modern languages of the world. The upper planes contain historical characters and additional unconventional symbols.

The first computers used ASCII *American Standard Code for Information Interchange*, a 7-bit code that defines all the characters of the English language: 26 lowercase letters (without diacritics), 26 uppercase letters, 10 digits, 32 punctuation symbols, 33 codes control and a blank space, for a total of 128 positions. Taking the additional bit within a byte, we will have space for another 128 symbols, but still insufficient for all in the world. This results in numerous pages of extended ASCII codes, which is a big problem to share texts, since the same numeric code can represent different symbols according to the ASCII page used (Figure 13.8).

Already in the early 90s, with the advent of the Internet, this problem worsened, as the exchange of information between machines of different nature and country became

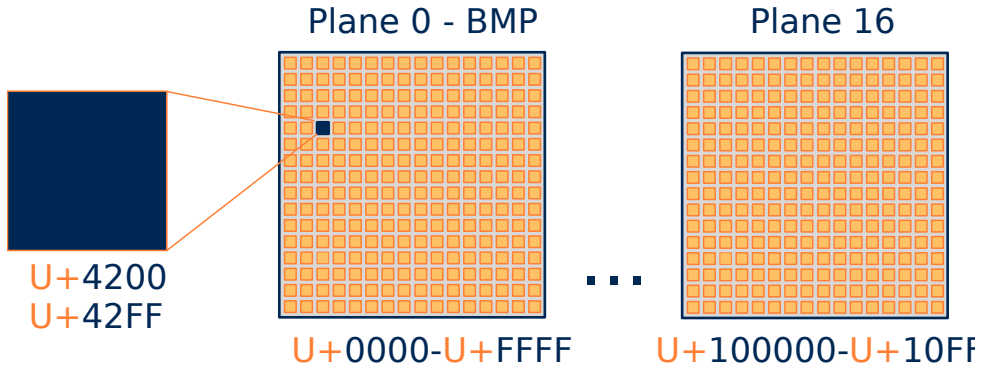

Figure 13.7: Unicode has 17 planes of 256x256 codepoints each.

Extended 1 0 0 0 0 0 0 0 US-ASCII

1252 WINDOWS LATIN 1 (ANSI)																1253 WINDOWS GREEK															
	20	30	40	50	60	70	80	90	A0	B0	C0	D0	E0	F0		20	30	40	50	60	70	80	90	A0	B0	C0	D0	E0	F0		
0	0	@	P	`	p											0	@	P	`	p											
1	!	1	A	Q	a	q										!	1	A	Q	a	q										
2	"	2	B	R	b	r										"	2	B	R	b	r										
3	#	3	C	S	c	s										#	3	C	S	c	s										
4	\$	4	D	T	d	t										\$	4	D	T	d	t										
5	%	5	E	U	e	u										%	5	E	U	e	u										
6	&	6	F	V	f	v										&	6	F	V	f	v										
7	'	7	G	W	g	w										'	7	G	W	g	w										
8	(8	H	X	h	x										(8	H	X	h	x										
9)	9	I	Y	i	y)	9	I	Y	i	y										
A	*	:	J	Z	j	z										*	:	J	Z	j	z										
B	+	;	K	[k	{										+	;	K	[k	{										
C	<	<	L	\	l											<	<	L	\	l											
D	=	=	M]	m	}										=	=	M]	m	}										
E	>	>	N	^	n	~										>	>	N	^	n	~										
F	/	/	?	O	_	o										/	/	?	O	_	o										

Figure 13.8: On each Extended ASCII page, the top 128 codes represent different characters.

something everyday. The Unicode Consortium (Figure 13.9) was constituted in California in January of 1991 and, in October of the same year, the first volume of the Unicode standard was published.



Figure 13.9: Full members of the Unicode Consortium.

13.4.1. UTF encodings

Each *codepoint* needs 21 bits to be represented (5 for the plane and 16 for the displacement). This match very badly with the basic types in computers (8, 16 or 32 bits). For this reason, three *Unicode Translation Format - UTF* encodings have been defined, depending on the type of data used in the representation (Figure 13.10).

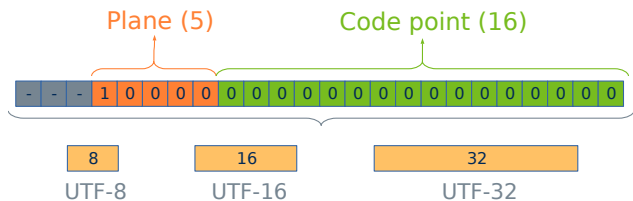

Figure 13.10: Encodings to store 21-bit *codepoints* by elements of 8, 16, or 32.

13.4.2. UTF-32

Without any problem, using 32 bits we can store any *codepoint*. We can also randomly access the elements of an array using an index, in the same way as the classic ASCII C (char) strings. The bad news is the memory requirements. A UTF32 string needs four times more space than an ASCII.

```

const char32_t code1[] = U"Hello";
const char32_t code2[] = U"áéíóú";
uint32_t s1 = sizeof(code1); /* s1 == 24 */
uint32_t s2 = sizeof(code2); /* s2 == 24 */
for (i = 0; i < 5; ++i)
{
    /* Accessing by index */
    if (code1[i] == 'H')
        return i;
}

```

13.4.3. UTF-16

UTF16 halves the space required by UTF32. It is possible to store a *codepoint* per element as long as we do not leave the 0 plane (BMP). For higher planes, two UTF16 elements (32bits) will be necessary. This mechanism, which encapsulates the higher planes within the BMP, is known as **surrogate pairs**.

```

const char16_t code1[] = u"Hello";
const char16_t code2[] = u"áéíóú";

```

```

uint32_t s1 = sizeof(code1); /* s1 == 12 */
uint32_t s2 = sizeof(code2); /* s2 == 12 */
for (i = 0; i < 5; ++i)
{
    /* DANGER! Only BMP */
    if (code1[i] == 'H')
        return i;
}

```

To iterate over a UTF16 string that contains characters from any plane, it must be used `unicode_next`.

13.4.4. UTF-8

UTF8 is a variable length code where each *codepoint* uses 1, 2, 3 or 4 bytes.

- 1 byte (**0-7F**): the 128 symbols of the original ASCII. This is a great advantage, since US-ASCII strings are valid UTF8 strings, without the need for conversion.
- 2 bytes (**80-7FF**): Diacritical and Romance language characters, Greek, Cyrillic, Coptic, Armenian, Hebrew, Arabic, Syriac and Thaana, among others. A total of 1920 *codepoints*.
- 3 bytes (**800-FFFF**): Rest of the plane 0 (BMP).
- 4 bytes (**10000-10FFFF**): Higher planes (1-16).

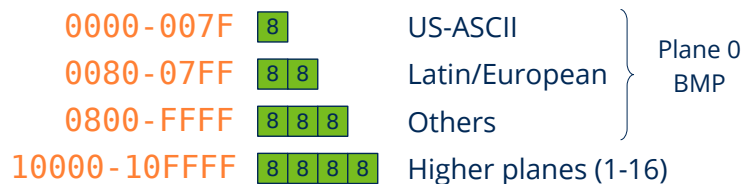

Figure 13.11: Each character in UTF8 uses 1, 2, 3 or 4 bytes.

More than 90% of websites use UTF8 (august of 2018¹), because it is the most optimal in terms of memory and network transmission speed. As a disadvantage, it has associated a small computational cost to encode/decode, since it is necessary to perform bit-level operations to obtain the *codepoints*. It is also not possible to randomly access a specific character by index, we have to process the entire string.

```

const char_t code1[] = "Hello";
const char_t code2[] = "áéíóú";
const char_t *iter = code1;
uint32_t s1 = sizeof(code1); /* s1 == 6 */
uint32_t s2 = sizeof(code2); /* s2 == 11 */

```

¹https://w3techs.com/technologies/overview/character_encoding/all

```

for (i = 0; i < 5; ++i)
{
    if (unicode_to_u32(iter, ekUTF8) == 'H')
        return i;
    iter = unicode_next(iter, ekUTF8);
}

```

13.4.5. Using UTF-8

UTF8 is the encoding required by all the NAppGUI SDK functions. The reasons why we have chosen UTF-8 over other encodings have been:

- It is the natural evolution of the US-ASCII.
- The applications will be directly compatible with the vast majority of Internet services (JSON/XML).
- In multi-lingual environments the texts will occupy less space. Statistically, the 128 ASCII characters are the most used on average and only need one byte in UTF8.
- As a disadvantage, in applications aimed exclusively at the Asian market (China, Japan, Korea - CJK), UTF8 is less efficient than UTF16.

Within NAppGUI applications they can coexist different representations (`char16_t`, `char32_t`, `wchar_t`). However, we **strongly recommend the use of UTF8** in favor of portability and to avoid constant conversions within the API. To convert any string to UTF8 the `unicode_convers` function is used.

```

wchar_t text[] = L"My label text.";
char_t ctext[128];
unicode_convers((const char_t*)text, ctext, ekUTF16, ekUTF8, 128);

```

NAppGUI does not offer support for converting pages from Extended ASCII to Unicode.

The `Stream` object provides automatic UTF conversions when reading or writing to I/O channels using the methods `stm_set_write_utf` and `stm_set_read_utf`. It is also possible to work with the `String` type (dynamic strings), which incorporates a multitude of functions optimized for the UTF8 treatment. We can include constant text strings directly in the source code (Figure 13.12), although the usual thing will be to write them in resource files (“*Resources*” (page 99)). Obviously, we must save both the source and resource files in UTF8. All current development environments support the option:

- By default, Visual Studio saves the source files in ASCII format (Windows 1252). To change to UTF8, go to **File->Save As->Save with encoding->Unicode (UTF8 Without Signature)- Codepage 65001**. There is no way to set this configuration for the entire project :-).

- In Xcode it is possible to establish a global configuration. Preferences->Text editing->Default Text Encoding->Unicode (UTF-8).
- In Eclipse it also allows a global configuration. Window->Preferences->General ->Workspace->Text file encoding.

```
static const char_t text[] = {
    "Hello World!",
    "「こんにちは世界」",
    "你好, 世界!",
    "Привет мир!",
    "Γειά σου Κόσμε!" };

/* API works with UTF8 */
label_text(label, text[2]);
button_text(button, text[3]);
```

Figure 13.12: UTF8 constants in a C source file.

13.5. Maths

BMath offers a compact interface on the elementary mathematical functions of the C standard library. It also defines some of the most used constants, such as the number Pi, conversions between degrees and radians or the root of 2.

- Use `bmath_cosf` to calculate the cosine of an angle (*wrapper* over `cosf()`).
- Use `bmath_sqrtf` to calculate the square root (*wrapper* over `sqrtf()`).

13.5.1. Random numbers

BMath includes a seed-based pseudo-random number generator. From the same seed, the sequence of numbers generated will always be the same. The sequences produced by two different seeds will be radically disparate. Hence they are called pseudo-random.

- Use `bmath_rand_seed` to set the random number seed.
- Use `bmath_randf` to get a random floating point number, within an interval.

In the case of multi-threaded applications, this sequence may vary depending on the order of execution of the threads, since these functions **are not re-entrant**. You must use an “environment” of random numbers for each thread in question, in case you need to always ensure the same sequence (deterministic algorithms).

- Use `bmath_rand_env` to create a random number safe environment.
- Use `bmath_rand_mtf` to get a random number from an environment.

13.6. Standard functions

`BLib` includes useful functions from the C standard library that don't fit in other modules like `BMath` or `BMem`. As in `<stdlib.h>` we find text conversion functions, algorithms or interaction with the environment.

- Use `blib_strcmp` to compare two text strings.
- Use `blib_qsort` to sort a vector of elements.
- Use `blib_bsearch` to perform a dichotomous search on an ordered vector.
- Use `blib_abort` to end program execution.

13.6.1. Date conversion

- Use `blib_strftime` to convert a date to text.

Specifier	Replaced By	Example
<code>%a</code>	Abbreviated weekday name	Sun
<code>%A</code>	Full weekday name	Sunday
<code>%b</code>	Abbreviated month name	Mar
<code>%B</code>	Full month name	March
<code>%c</code>	Date and time representation	Sun Aug 19 02:56:02 2012
<code>%d</code>	Day of the month (01-31)	19
<code>%H</code>	Hour in 24h format (00-23)	14
<code>%I</code>	Hour in 12h format (01-12)	05
<code>%j</code>	Day of the year (001-366)	231
<code>%m</code>	Month as a decimal number (01-12)	08
<code>%M</code>	Minute (00-59)	55
<code>%p</code>	AM or PM designation	PM
<code>%S</code>	Second (00-59)	02
<code>%U</code>	Week number with the first Sunday as the first day of week one (00-53)	33
<code>%w</code>	Weekday as a decimal number with Sunday as 0 (0-6)	4
<code>%W</code>	Week number with the first Monday as the first day of week one (00-53)	34

Specifier	Replaced By	Example
%x	Date representation	08/19/12
%X	Time representation	02:50:06
%y	Year, last two digits (00-99)	01
%Y	Year	2012
%Z	Timezone name or abbreviation	CDT
%%	A % sign	%

Table 13.1: Date format modifiers.

13.7. Standard I/O

All processes have input and output channels by default, without the need to create them explicitly. By channels we mean *streams* or data flows.

- Use `bstd_printf` to write text to standard output.
- Use `bstd_read` to read bytes from standard input.

Each running process has three standard communication channels:

- **stdin:** data input. The process will read data that comes from outside.
- **stdout:** data output. The process will write results on this channel.
- **stderr:** error output. The process will write on this channel information regarding errors.

It's like having three perpetually open files where the program can read and write without limits. When we execute a process from the Console or the Terminal, `stdin` automatically connects to the keyboard and `stdout/stderr` to the screen (Figure 13.13). However, these standard channels can be redirected to use files as input sources or output destinations:

```
dir > out.txt
ls > out.txt
sort < out.txt
```

In this code snippet, the result of the command `dir` (`ls` in Unix) has been redirected to the file `out.txt`, so we will not see anything on the screen. On the other hand, the command `sort` it does not wait for the user to enter through the keyboard. Simply taking the file `out.txt`, sorting its lines. Therefore, whenever we write applications on the command line, we should conveniently use these standard channels without making

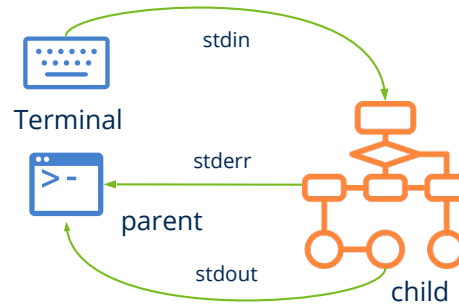

Figure 13.13: Executing a process from the Terminal.

presumptions from where the information processed by the application comes from or where it goes.

13.8. Memory

From the programmer perspective, access to memory is done through variables and manipulated through the language operators (+, -, *, =, ...) and always in the same way, regardless of how the variables were created or in what memory zone they are hosted. Within `bmem.h` we have several functions to make copies, assignments or checks of generic memory blocks. This module also defines functions for dynamic memory manipulation (*Heap*).

- Use `bmem_malloc` to reserve a dynamic memory block.
- Use `bmem_free` to free a block of dynamic memory.
- Use `bmem_copy` to copy the contents of two memory blocks, previously reserved.

13.8.1. Stack Segment

The memory of a compiled and running C program is divided into several segments. One of them is the *stack*, a space of variable but limited size, where local variables and function calls (*call stack*) are stored. It grows and shrinks as the process enters and leaves areas or functions (Figure 13.14). It is automatically managed by the compiler as a LIFO *Last-in First-out structure*, so it goes unnoticed most of the time, since it does not require extra attention from the programmer. We are aware of its existence when receiving the *Stack Overflow* error, usually caused by infinite recursion or the reservation of very large C vectors (Listing 13.1). The debugger allows us to inspect the state of the stack at execution time “*Debugging the program*” (page 63).

Listing 13.1: Two simple cases that cause the stack overflow.

```
int func(int n) { func(n); } // Stack Overflow

float v[2000000]; // Stack Overflow
```

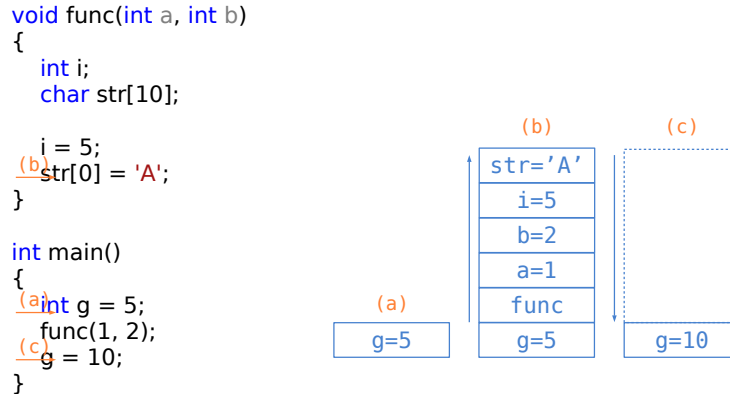

Figure 13.14: Stack state in different points of the program.

While the use of the *stack* is ideal due to its high performance, security and ease of use, sometimes falls short. On the one hand, it is necessary to foresee in the design time the amount of memory needed and define it statically (eg. `struct Product pr[100];`), something very inflexible when it comes to building real applications. On the other hand, variables are destroyed when closing a scope or leaving a function, which prevents sharing data globally.

13.8.2. Heap Segment

The *heap* is a memory zone that the process can request on demand, through calls to the system. It is complementary to the *stack* and is characterized by:

- It can be accessed globally, from any point of the program through a pointer.
- The amount of available memory is practically unlimited.
- It is less efficient than the *stack*.
- Requires management. Operating systems provide functions for requesting dynamic memory blocks (`HeapAlloc()`, `sbrk()`), being the responsibility of the process, or rather the programmer, to release these blocks when they are no longer needed.

As allocations and de-allocations can be made in any order, internal fragmentation occurs as the program progresses (Figure 13.15). Here would come into play the so-called **memory manager**, which are algorithms that allow optimizing the use of the heap by compacting it and reusing the released blocks. The standard C library provides the familiar functions `malloc()` / `free()`, which implement a generic memory manager through system calls.

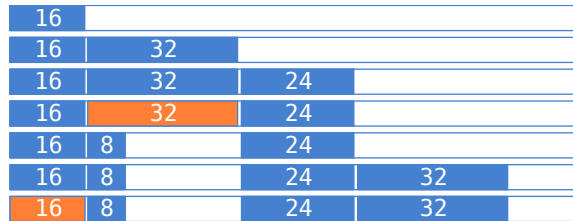

Figure 13.15: Fragmentation of the *heap* during the execution of the process.

NAppGUI implements its own dynamic memory manager/auditor “Heap - Memory manager” (page 196) very optimized to serve numerous requests of small size, which is what applications demand normally. `bmem_malloc/bmem_free` connect to the operating system through system calls and should not be used directly.

Osbs library

There is no neat distinction between operating system software and the software that runs on top of it.

Jim Allchin

14.1 Osbs	174
14.2 Processes	175
14.2.1 Launching processes	175
14.2.2 Multi-processing examples	176
14.3 Threads	178
14.3.1 Throwing threads	179
14.3.2 Shared variables	179
14.3.3 Multi-thread example	180
14.4 Mutual exclusion	183
14.4.1 Locks	183
14.5 Loading libraries	183
14.5.1 Library search paths	184
14.5.2 Search order in Windows	184
14.5.3 Search order on Linux/macOS	185
14.6 Files and directories	185
14.6.1 File System	185
14.6.2 Files and data streams	186
14.6.3 Filename and pathname	186
14.6.4 Home and AppData	187
14.7 Sockets	187
14.7.1 Client/Server example	188
14.8 Time	191

14.1. Osbs

osbs (*Operating System Basic Services*) is a portable wrapper that allows applications to communicate with the operating system core at the level of processes, memory, files and networks. This communication is carried out through a series of **system calls** (Figure 14.1) which vary according to the operating system for which we are programming. It is the non-graphic lowest level API to communicate with hardware devices and access the machine resources. Below are the device drivers managed directly by the kernel, to which applications have access denied.

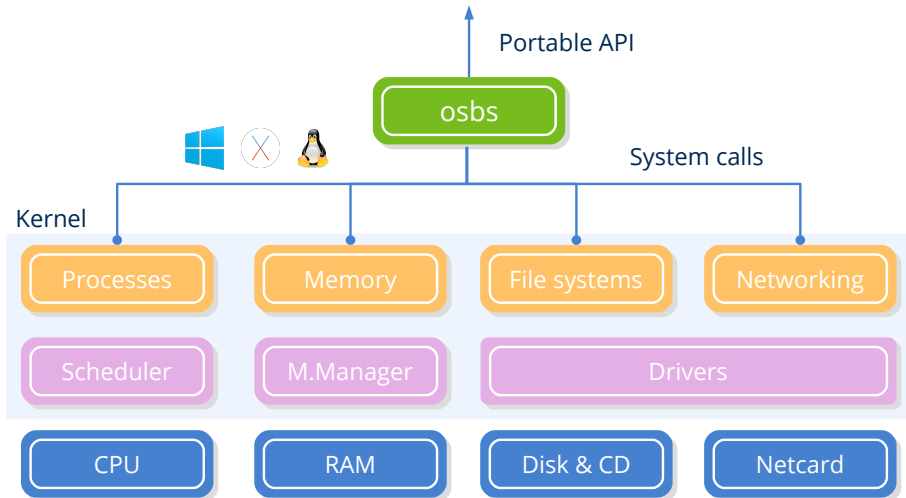

Figure 14.1: System calls are the gateway to the operating system kernel.

Darwin, the macOS kernel, and Linux are Unix-like systems, therefore, they share the same system calls (with subtle differences). But Windows presents a radically different architecture and function set. The NAppGUI **osbs** library is nothing more than a small wrapper that internally handles these differences and provides a common way to access the same resources on different platforms (Figure 14.2). It only depends on “*Sewer*” (page 156) and its functionalities have been divided into different modules:

- “*Processes*” (page 175), “*Threads*” (page 178), “*Mutual exclusion*” (page 183).
- “*Loading libraries*” (page 183).
- “*Files and directories*” (page 185).

- “Sockets” (page 187).
- “Time” (page 191).

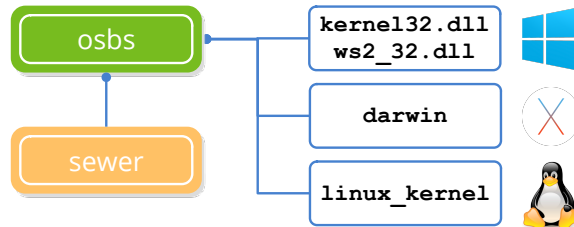

Figure 14.2: *osbs* dependencies. See “NAppGUI API” (page 151).

14.2. Processes

From the programmer perspective, multi-processing is the possibility of launching and interacting with other processes (children) from the main process (parent). The operating system can execute the child process in another CPU core (*true multitasking*) or in the same as the parent (*context switch*). This is a system decision in which the programmer can not influence and will depend on the processor type and its workload. The final effect will be that both processes (parent and child) run in parallel.

- Use `bproc_exec` to launch a new process from the application itself.
- Use `bproc_read` to read from the standard output of the process.
- Use `bproc_write` to write to the standard input of the process.

14.2.1. Launching processes

`bproc_exec` will launch a process from our own C program in a similar way as the Terminal does (Figure 14.3). In this case, the “Standard I/O” (page 168) `stdin`, `stdout` and `stderr` will be redirected to the `Proc` object through anonymous pipes. From here, we can use `bproc_write` to write on the son `stdin` channel and `bproc_read` to read from his `stdout`. The rules of reading/writing are those that govern the operating system *pipes* and that we can summarize in:

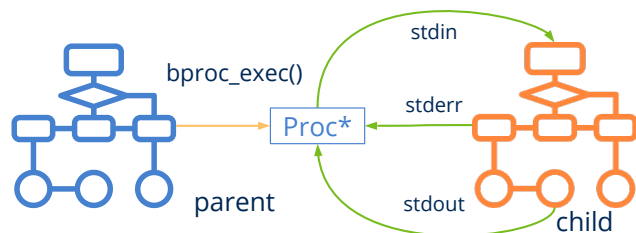

Figure 14.3: Launching a process from our own C code.

- If the parent calls `bproc_read` and the child has not written anything (empty buffer), the parent will be blocked (wait) until there is information in the child's output channel.
- If the child ends and parent is waiting to read, `bproc_read` will return `FALSE` and the parent will continue his execution.
- If the parent calls `bproc_write` and the writing buffer is full, the parent will block (wait) until the child reads from his `stdin` and free space in the channel.
- If the child ends and the father is blocked by writing, `bproc_write` will return `FALSE` and the parent will continue his execution.
- Some commands or processes (eg `sort`) will not start until reading the entire `stdin` contents. In these cases, the parent process must use `bproc_write_close` to indicate to the child that the writing on his `stdin` has finished.
- When the parent calls `bproc_close`, all the I/O channels will be closed and both processes will continue their execution independently. To finish the execution of the child process (*kill*) use `bproc_cancel`.
- `bproc_wait` will stop the parent process until the child completes. To avoid overloading the child output buffer `stdout`, close the channel through `bproc_read_close`.
- `bproc_finish` will check, in a non-blocking way, if the child has finished running.

14.2.2. Multi-processing examples

Let's look at some practical examples of IPC *Inter-Process Communication* using the standard I/O channels in linked parent-child processes. In (Listing 14.1) we will dump the child process `stdout` output in a file. In (Listing 14.2) we will redirect both channels, we will write in `stdin` and we will read from `stdout` using disk files. Finally, we will implement an asynchronous protocol where the parent and child exchange requests and responses. In (Listing 14.4) we show the code of the child process, in (Listing 14.3) the parent process and in (Listing 14.5) the result of the communication, written by the parent process.

Listing 14.1: Reading from a process `stdout` and saving it in a file.

```
byte_t buffer[512];
uint32_t rsize;
File *file = bfile_create("out.txt", NULL);
Proc *proc = bproc_exec("dir C:\Windows\System32", NULL);
while(bproc_read(proc, buffer, 512, &rsize, NULL) == TRUE)
    bfile_write(file, buffer, rsize, NULL, NULL);
bproc_close(&proc);
bfile_close(&file);
```

The shell commands are not portable in general. We use them only as an example.

Listing 14.2: Redirecting the stdin and stdout of a process.

```
byte_t buffer[512];
uint32_t rsize;
File *fsrc = bfile_open("members.txt", ekFILE_READ, NULL);
File *fdes = bfile_create("sorted_members.txt", NULL);
Proc *proc = bproc_exec("sort", NULL);

// Writes to stdin
while (bfile_read(fsrc, buffer, 512, &rsize, NULL) == TRUE)
    bproc_write(proc, buffer, rsize, NULL, NULL);

// Closes child stdin
bproc_write_close(proc);

// Reads child stdout
while (bproc_read(proc, buffer, 512, &rsize, NULL) == TRUE)
    bfile_write(fdes, buffer, rsize, NULL, NULL);

bfile_close(&fsrc);
bfile_close(&fdes);
bproc_close(&proc);
```

Listing 14.3: Asynchronous protocol (parent process).

```
Proc *proc;
uint32_t commands[] = { 326, 32, 778, 123, 889, 712, 1, 55, 75, 12 };
uint32_t exit_command = 0;
uint32_t i;

proc = bproc_exec("child", NULL);

for (i = 0; i < 10; ++i)
{
    uint32_t response;
    uint32_t time;
    // Send command to child
    bproc_write(proc, (byte_t*)&commands[i], sizeof(uint32_t), NULL);

    // Waits for child response
    bproc_read(proc, (byte_t*)&response, sizeof(uint32_t), NULL);
    bproc_read(proc, (byte_t*)&time, sizeof(uint32_t), NULL);
    bstd_printf("Child command %d in %d milliseconds.\n", response, time);
}

bproc_write(proc, (byte_t*)&exit_command, sizeof(uint32_t), NULL);
bproc_close(&proc);
```

Listing 14.4: Asynchronous protocol (child process).

```

for (;;)
{
    uint32_t command;
    // Reads from standard input a command from parent.
    if (bstd_read((byte_t*)&command, sizeof(command), NULL) == TRUE)
    {
        if (command != 0)
        {
            // Waits random time (simulates processing).
            uint32_t timer = bmath_randi(1000, 2000);
            bthread_sleep(timer);

            // Writes to standard output the response to parent.
            bstd_write((const byte_t*)&command, sizeof(command), NULL);
            bstd_write((const byte_t*)&timer, sizeof(timer), NULL);
        }
        else
        {
            // Command 0 = Exit
            break;
        }
    }
}

```

Listing 14.5: Parent process execution result.

```

Child command 326 in 1761 milliseconds.
Child command 32 in 1806 milliseconds.
Child command 778 in 1989 milliseconds.
Child command 123 in 1909 milliseconds.
Child command 889 in 1043 milliseconds.
Child command 712 in 1153 milliseconds.
Child command 1 in 1780 milliseconds.
Child command 55 in 1325 milliseconds.
Child command 75 in 1157 milliseconds.
Child command 12 in 1426 milliseconds.

```

14.3. Threads

The **threads** are different execution paths within the same process (Figure 14.4). They are also known as **light processes**, since they are more agile to create and manage than the processes themselves. They share code and memory space with the main program, so it is very easy to exchange information between them through memory variables. A thread starts its execution in a method known as *thread_main* and, at the moment it is launched, it runs in parallel with the main thread. Like the processes, they are objects controlled by the core of the system that will dictate, ultimately, whether the threads will be executed

in another CPU core (*true multitasking*) or will share it (*context switch*).

- Use `bthread_create` to create a new thread.
- Use `bthread_wait` to force the main thread to wait for the thread to execute.

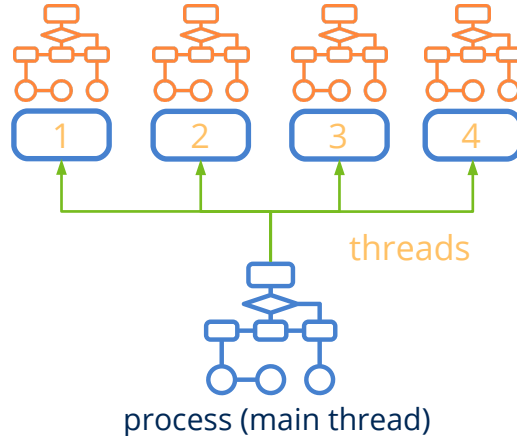

Figure 14.4: A process with multiple execution threads.

14.3.1. Throwing threads

Each call to `bthread_create` will create a new thread in parallel starting at the function passed as a parameter (*thread_main*). The “natural” way to end it is by returning from *thread_main*, although it is possible to abort it from the main thread.

Basic code to launch a parallel execution thread.

```
static uint32_t i_thread(ThData *data)
{
    // Do something
    ...
    // Thread execution ends
    return 0;
}

Thread *thread = bthread_create(i_thread, data, ThData);
// Main thread will continue here
// Second thread will run 'i_thread'
```

14.3.2. Shared variables

Each new thread has its own “*Stack Segment*” (page 169) therefore, all automatic variables, function calls and dynamic allocations will be private to said thread. But it can also receive global data from the process through the *thread_main* data parameter. We must be careful when accessing global data through multiple concurrent threads, since modifications made by other threads can alter the logical code execution, producing errors

that are very difficult to debug. The program (Listing 14.6) is correct for single-thread programs, but if the variable `vector` is accessed by two simultaneous threads, can lead to a *Segmentation Fault* error if thread-1 frees memory while thread-2 is executing the loop.

Listing 14.6: Dangerous access to shared variables.

```
if (shared->vector != NULL)
{
    shared->total = 0;
    for(i = 0; i < shared->n; i++)
        shared->total += shared->vector[i];
    bmem_free(shared->vector);
    shared->vector = NULL;
}
```

To avoid this problem, we will have to protect the access to shared variables through a `Mutex` (Listing 14.7). This “*Mutual exclusion*” (page 183) mechanism guarantees that only one thread can access the resource in a moment of time. A thread will be stopped if it intends to execute the code located between `bmutex_lock` and `bmutex_unlock` if another thread is within this *critical section*.

Listing 14.7: Secure access to shared variables.

```
bmutex_lock(shared->mutex);
if (shared->vector != NULL)
{
    shared->total = 0;
    for(i = 0; i < shared->n; i++)
        shared->total += shared->vector[i];
    bmem_free(shared->vector);
    shared->vector = NULL;
}
bmutex_unlock(shared->mutex);
```

14.3.3. Multi-thread example

The tricky part of multi-threaded programming is to decompose a solution into parts that can run in parallel and organize the data structures so that this can be carried out in the most balanced way possible. In (Listing 14.8) the program will run four times faster (x4) since a perfect division of the problem has been made (Figure 14.5). This is just a theoretical example and this result will be very difficult to achieve in real situations. We must also minimize the number of shared variables and the time of the critical sections, otherwise the possible inter-blocks will reduce the gain.

Listing 14.8: Multi-threaded processing of a very large vector.

```
typedef struct _app_t App;
typedef struct _thdata_t ThData;
```

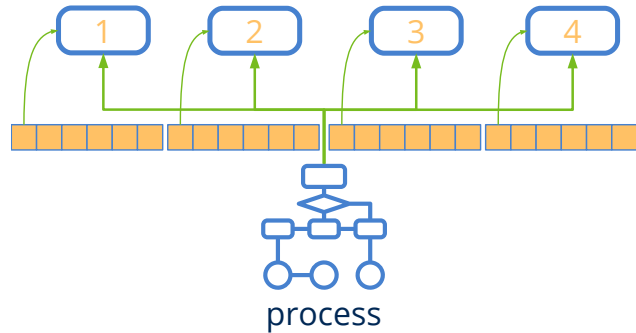

Figure 14.5: Collaboration of four threads in a vector calculation.

```

struct _app_t
{
    uint32_t total;
    uint32_t n;
    uint32_t *elems;
    Mutex *mutex;
};

struct _thdata_t
{
    uint32_t thread_id;
    uint32_t start;
    uint32_t end;
    uint64_t time;
    App *app;
};

static uint32_t i_thread(ThData *data)
{
    uint32_t i, total = 0;
    uint64_t t1 = btime_now();
    for (i = data->start; i < data->end; ++i)
    {
        // Simulates processing
        uint32_t time = bmath_randi(0, 100);
        bthread_sleep(time);
        total += data->app->elems[i];
    }

    // Mutual exclusion access to shared variable 'total'
    bmutex_lock(data->app->mutex);
    data->app->total += total;
    bmutex_unlock(data->app->mutex);
    data->time = (btime_now() - t1) / 1000;
    return data->thread_id;
}

```

```

// Threads creating function
uint32_t i, m;
uint64_t t;
App app;
ThData thdata[4];
Thread *thread[4];

// App data vector
i_init_data(&app);
app.mutex = bmutex_create();
m = app.n / 4;

// Thread data
for (i = 0; i < 4; ++i)
{
    thdata[i].thread_id = i;
    thdata[i].app = &app;
    thdata[i].start = i * m;
    thdata[i].end = (i + 1) * m;
}

// Launching threads
t = btime_now();
for (i = 0; i < 4; ++i)
    thread[i] = bthread_create(i_thead, &thdata[i], ThData);

// Wait for threads end
for (i = 0; i < 4; ++i)
{
    uint32_t thid = bthread_wait(thread[i]);
    bstd_printf("Thread %d finished in %d ms.\n", thid, thdata[thid].time);
    bthread_close(&thread[i]);
}

// Process total time
t = (btime_now() - t) / 1000;
bstd_printf("Processing result = %d in %d ms.\n", app.total, t);

bmutex_close(&app.mutex);

```

Listing 14.9: Resultado.

```

Thread 0 finished in 13339 ms.
Thread 1 finished in 12506 ms.
Thread 2 finished in 12521 ms.
Thread 3 finished in 12999 ms.
Processing result = 499500 in 13344 ms.

```

14.4. Mutual exclusion

In processes with multiple threads, mutual exclusion guarantees that only one of them can execute a **critical section** at a specific moment of time. The critical section is a block of code that normally protects a shared resource that does not support concurrent access.

- Use `bmutex_create` to create a lock.
- Use `bmutex_lock` to lock a critical section.
- Use `bmutex_unlock` to unlock a critical section.

14.4.1. Locks

Locks or `Mutex` are synchronization objects managed by the operating system that mark the beginning and end of a critical section (Figure 14.6). When a thread is going to access a certain share, you must call the method `bmutex_lock` to guarantee exclusive access. If another thread is using the resource (it has previously called `bmutex_lock`), the current thread will stop until the resource is released through `bmutex_unlock`. Blocking and unblocking threads is handled by the operating system itself. The programmer should only worry about identifying and protecting the critical sections. “*Multi-thread example*” (page 180).

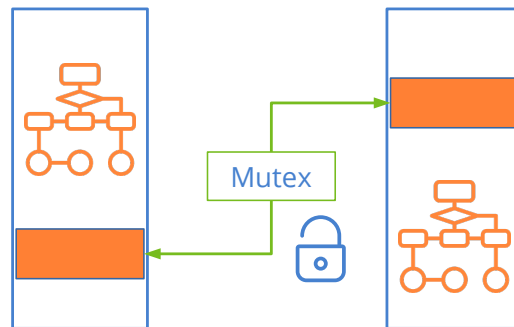

Figure 14.6: A mutex protecting the critical sections of two threads, which can not be executed concurrently. The rest of the code can run in parallel.

14.5. Loading libraries

The usual, in projects of relative size, is to divide the program code into libraries in order to be able to reuse them in different projects. The link of these libraries within the final executable can be done in three ways:

- **Compile time:** The library code is copied into the executable, forming an inseparable part of it (static libraries) (Figure 14.7) (a).
- **Load time:** The library code is distributed separately (dynamic libraries) and is loaded together with the main program, at the same time (Figure 14.7) (b).

- **Runtime:** Dynamic libraries that the program loads when it needs them (Figure 14.7) (c).

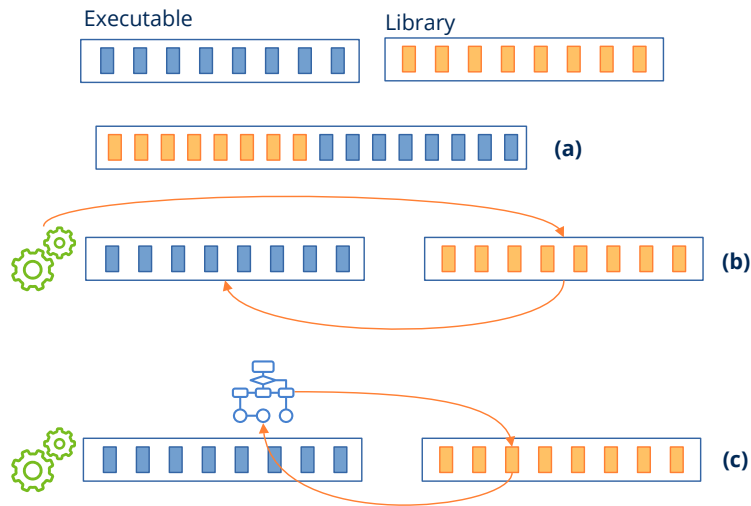

Figure 14.7: Library link and dynamic loading.

The linking process is relatively complicated and is handled automatically by the compiler and operating system's loader. The programmer should only intervene in the third case, since it is necessary to include code to load the libraries and access the appropriate methods or variables at all times.

- Use `dlib_open` to load a library at runtime.
- Use `dlib_proc` to get a pointer to a library function.
- Use `dlib_var` to get a pointer to a library variable.

14.5.1. Library search paths

A dynamic library is in a different file than the executables that can make use of it. Each operating system implements different search strategies that we must know to install and/or configure the programs correctly.

14.5.2. Search order in Windows

- Directory path of `dlib_open`.
- The same directory as the executable.
- The current directory `bfile_dir_work`.
- Directory `%SystemRoot%\System32`.

- Directory %SystemRoot%.
- The directories specified in the environment variable PATH.

14.5.3. Search order on Linux/macOS

- The directories specified in the environment variable LD_LIBRARY_PATH (Linux) or DYLD_LIBRARY_PATH (macOS).
- The directories specified in the executable rpath.
- System directories /lib, /usr/lib, etc.

14.6. Files and directories

14.6.1. File System

The file system (*filesystem*) is the hierarchical structure composed of directories and files that allows organizing the persistent data of the computer (Figure 14.8). It is something with which computer users are very familiar, especially after the emergence of graphic systems that introduced the analogy of desktop, folder and document. It starts in a directory called root (/ on Unix or C:\ on Windows) and, from here, all sub-directories and files hang down forming a tree that grows deep. At the programming level, the file system is managed through system calls that allow directories to be created, browse their content, open files, delete them, obtain attributes, etc.

- Use `bfile_create` to create a new file.
- Use `bfile_dir_create` to create a directory.
- Use `bfile_dir_open` to open a directory to explore its contents.
- Use `bfile_dir_get` to get information about a directory entry.

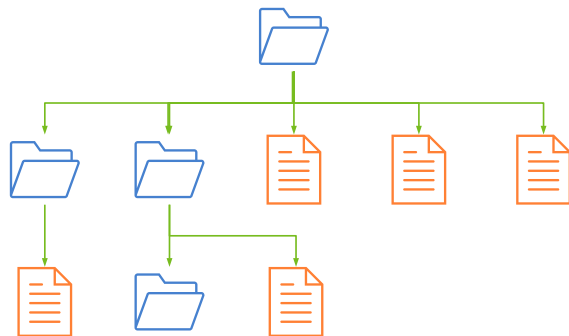

Figure 14.8: Typical structure of a file system.

14.6.2. Files and data streams

A process can read or write data to a file after opening an I/O (“Streams” (page 201)) which provides a stream of binary data to or from the process itself (Figure 14.9). There is a pointer that moves sequentially each time data is read or written. It is initially in byte 0, but we can modify it to access random positions in the file without reading the content (Figure 14.10). This can be very useful when working with large files whose data is indexed in some way.

- Use `bfile_open` to open an existing file.
- Use `bfile_read` to read binary data from a file.
- Use `bfile_write` to write binary data to a file.
- Use `bfile_seek` to modify the file pointer.

Figure 14.9: After opening a file, the process has an I/O channel to read or write data.

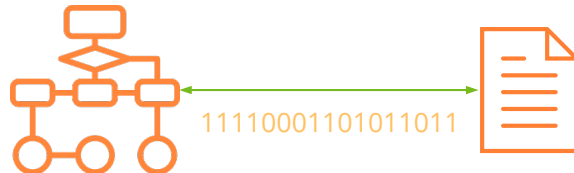
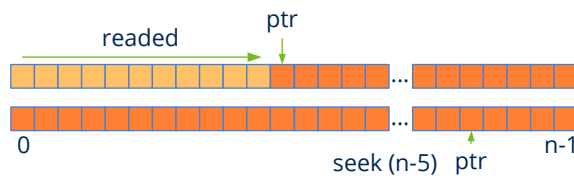

Figure 14.10: Sequential read or random access.



14.6.3. Filename and pathname

These two concepts are recurrent and widely used by API functions that manipulate files. When we navigate through the contents of a directory `bfile_dir_get`, we obtain a sequence of *filenames* that is the “flat” name of the element (file or subdirectory) without including its path within the file system (without characters `'/'` or `'\'`). On the other hand the *pathname* is a sequence of one or several *filenames* separated by `'/'`, `'\'`, which indicates the way forward to locate a certain element. This path can be **absolute** when it starts with the root directory (`C:\Users\john\docs\images\party.png`) or **relative** (`docs\images\party.png`) when it indicates the partial route from the process current *working directory*.

- Use `bfile_dir_work` to get the current working directory.
- Use `bfile_dir_set_work` to set the working directory.

14.6.4. Home and AppData

These are two typical directories used by applications to store files relative to a particular user. On the one hand, *home* indicates the personal directory of the user currently registered in the system, typically `C:\Users\john` (Windows), `/home/john` (Linux) or `/Users/john` (macOS). On the other hand *appdata* is a directory reserved for saving temporary or configuration data of applications. Typical locations can be `C:\Users\john\AppData\Roaming` (Windows), `/home/john/.config` (Linux) or `/User/john/Library` (macOS). The usual thing will be to create a sub-folder with the name of the application `/User/john/Library/TheApp`.

- Use `bfile_dir_home` to get the user home directory.
- Use `bfile_dir_data` to get the application data directory.
- Use `bfile_dir_exec` to get the current executable directory.

14.7. Sockets

We can define a **socket** as a communication channel between two processes that are running on different machines. They use as a base the family of TCP/IP protocols that govern Internet communication from the first prototypes of the big network back in 1969. For its part, the IP protocol (*Internet Protocol*) is responsible for sending small data packets between two remote computers through the network. As there are packets that can be lost or take different paths when crossing the Internet nodes, TCP (*Transmission Control Protocol*) will be in charge of sorting them sequentially and re-ordering those that have been lost. Another important aspect that TCP adds is the concept of a **port**, which allows the same machine to have multiple connections open at the same time. The conjunction of TCP/IP provides the process of a reliable bidirectional communication channel (*full-duplex*) with the remote process and is the basis of the client/server model (Figure 14.11).

- Use `bsocket_connect` in the client process to create a communication channel with a remote server.
- Use `bsocket_server` in the server process to listen for client requests.
- Use `bsocket_accept` to accept a client's request and start communication.
- Use `bsocket_read` to read data from a socket.
- Use `bsocket_write` to write data to a socket.

Sockets are the lowest-level communication primitive accessible by applications. They are extremely fast but, in general, their functions are blocking, that is, they will stop the process until the other party responds.

Figure 14.11: TCP/IP sockets allow two processes to be connected through the Internet.

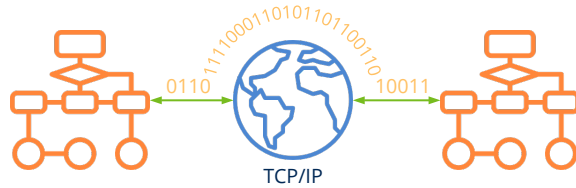

- `bsocket_connect` will stop the client process until the server responds or the `timeout` expires.
- `bsocket_accept` it will stop the server process until a request from a client arrives or the `timeout` is fulfilled.
- `bsocket_read` will stop the process until the other interlocutor writes data to the channel or the `timeout` is fulfilled.
- `bsocket_write` will stop the process until the other peer reads data from the channel and frees the intermediate buffer or the `timeout` is fulfilled.

Apart from these indications, working with *sockets* is very similar to working with files on disk. The TCP/IP implementation is complicated and is part of the operating system, so the establishment of the connection has been simplified through the system calls seen above. Since a socket only allows sending and receiving bytes, both partners need to define a **protocol** that indicates the order, sequence and type of data to be shared in such a way that communication is satisfactory and free of deadlocks. Some of the most used protocols on the Internet are: HTTP, SMTP, FTP, SSH, etc.

14.7.1. Client/Server example

As an example we are going to see how two processes exchange information through sockets. The protocol is extremely simple. After connection, the client (Listing 14.11) will send a series of numerical values to the server (Listing 14.10) and it will respond by resending the same value. When the client sends the value `UINT32_MAX` the communication will end.

Listing 14.10: Simple socket-based server.

```
uint32_t client_id = 0;
Socket *server_sock = bsocket_server(3444, 32, NULL);

if (server_sock == NULL)
    return;

for (;;)
{
    Socket *income_sock = NULL;
    uint32_t ip0, ip1;
    uint16_t p0, p1;
```

```

bstd_printf("Waiting for a new client\n");

income_sock = bsocket_accept(server_sock, 0, NULL);
if (income_sock == NULL)
    continue;

bstd_printf("Client %d arrives\n", client_id);
bsocket_local_ip(income_sock, &ip0, &p0);
bsocket_remote_ip(income_sock, &ip1, &p1);
bstd_printf("Local IP: %s:%d\n", bsocket_ip_str(ip0), p0);
bstd_printf("Remote IP: %s:%d\n", bsocket_ip_str(ip1), p1);

for (;;)
{
    byte_t data[4];
    uint32_t rsize;
    if (bsocket_read(income_sock, data, sizeof(data), &rsize, NULL) == TRUE
        ↪ )
    {
        uint32_t i;
        bsocket_ntoh4((byte_t*)&i, data);
        if (i != UINT32_MAX)
        {
            bstd_printf("Readed %d from client\n", i);
            bsocket_hton4(data, (byte_t*)&i);
            if (bsocket_write(income_sock, data, sizeof(data), NULL, NULL)
                ↪ == TRUE)
            {
                bstd_printf("Sending %d to client\n", i);
            }
            else
            {
                bstd_printf("Error writting to client\n");
                break;
            }
        }
        else
        {
            bstd_printf("Client %d say bye!\n", client_id);
            break;
        }
    }
    else
    {
        bstd_printf("Error reading from client\n");
        break;
    }
}

bstd_printf("\n\n");

```

```

    bsocket_close(&income_sock);
    client_id += 1;
}

bsocket_close(&server_sock);

```

Listing 14.11: Client process.

```

Socket *sock = NULL;
error_t error;
uint32_t i = 0;
byte_t data[4];

sock = bsocket_connect(bsocket_str_ip("192.168.1.21"), 3444, 5000, &error);

if (sock == NULL)
{
    bstd_printf("Connection error\n");
    return;
}

bsocket_read_timeout(sock, 2000);
bsocket_write_timeout(sock, 5000);

while (i < kPING_COUNTER)
{
    bsocket_hton4(data, (const byte_t*)&i);
    if (bsocket_write(sock, data, sizeof(data), NULL, NULL) == TRUE)
    {
        bstd_printf("Sending %d to server\n", i);
    }
    else
    {
        bstd_printf("Error writting in socket\n");
        break;
    }

    if (bsocket_read(sock, data, sizeof(data), NULL, NULL) == TRUE)
    {
        uint32_t j;
        bsocket_ntoh4((byte_t*)&j, data);
        bstd_printf("Readed %d from server\n", j);
        if (j != i)
        {
            bstd_printf("Error data corruption\n");
            break;
        }

        i += 1;
    }
    else

```

```

    {
        bstd_printf("Error reading in socket\n");
        break;
    }
}

if (i == kPING_COUNTER)
{
    i = UINT32_MAX;
    bsocket_hton4(data, (const byte_t*)&i);
    if (bsocket_write(sock, data, sizeof(data), NULL, NULL) == TRUE)
    {
        bstd_printf("Sending FINISH to server\n");
    }
    else
    {
        bstd_printf("Error writting in socket\n");
    }
}

bsocket_close(&sock);

```

14.8. Time

The operating system measures the passage of time using an internal clock, typically implemented by a counter of the *ticks* that have passed since an initial moment called *epoch*. In Unix-like systems this counter represents the number of seconds elapsed since January 1, 1970 UTC. However, in Windows it represents the number of 100 nanosecond intervals since January 1, 1601 coinciding with the beginning of the Gregorian calendar. In NAppGUI these values have been unified to work with *Unix Epoch* on all platforms.

- Use `btime_now` to get the number of micro-seconds elapsed since January 1, 1970 UTC.
- Use `btime_date` to get the system date.
- Use `btime_to_micro` and `btime_to_date` to convert dates to Unix Time and vice versa.

Figure 14.12: Unix Epoch Instant 0.



Unix Epoch:
00:00:00
January 1, 1970

The difference between two instants will give us the time elapsed during the execution of a task.

```
uint64_t ed, st = btime_now();

// Do something...
...

ed = btime_now();
bstd_printf("Total elapsed micro-seconds: %lu\n", ed - st);
```

14.9. Log

A *log* or diary is a record of anomalies that occur at runtime and that help to further debug the program or determine the cause of an error (Figure 14.13). This report is aimed more at programmers or software administrators and not at the end user, so it is advisable to include specific technical information on the cause of the problem. The messages addressed to the end user must be written in a more friendly tone, far from technicalities and sent to the standard output (`stdout` `stderr`) or to the window system, if we are facing a desktop application.

- Use `log_printf` to write a message to the execution log.

Figure 14.13: Messages related to internal anomalies of the program, can be sent to a *log*.

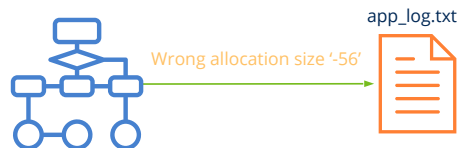

Core library

A strong core will improve your technique, strength, and stamina, and compliment everything you do.

Susan Trainor

15.1	Core	195
15.2	Heap - Memory manager	196
15.2.1	Multi-thread memory	197
15.2.2	How Heap Works	197
15.3	Buffers	200
15.4	Strings	200
15.5	Streams	201
15.5.1	Stream Types	201
15.5.2	File stream	202
15.5.3	Socket stream	202
15.5.4	Block stream	203
15.5.5	Memory stream	203
15.5.6	Standard stream	204
15.5.7	Null stream	204
15.5.8	Binary stream	205
15.5.9	Text stream	206
15.5.10	Tokens	207
15.5.11	Identifiers	208
15.5.12	Strings	209
15.5.13	Numbers	210
15.5.14	Symbols	210
15.5.15	Comments	211

15.5.16 Stream advantages	211
15.5.17 Unify serialization	211
15.5.18 More elegance	212
15.5.19 Higher productivity	213
15.5.20 Higher performance	213
15.5.21 Byte order	213
15.5.22 Stream state	214
15.6 Arrays	215
15.6.1 Registers or pointers	216
15.6.2 Type check	218
15.6.3 Constructors	219
15.6.4 Array loops	220
15.6.5 Copy objects	220
15.6.6 Serialization	221
15.6.7 Destructors	222
15.6.8 Sort and search	223
15.6.9 Arrays of basic types	225
15.7 Arrays (pointers)	225
15.8 Binary search trees	225
15.8.1 Iterators	227
15.8.2 Arrays vs Sets comparative	228
15.9 Binary search trees (pointers)	230
15.10 Regular expressions	230
15.10.1 Define patterns	230
15.10.2 Regular languages and automata	232
15.11 Data binding	233
15.11.1 Synchronization with graphical interfaces	234
15.11.2 Read and write JSON	235
15.11.3 Serialization with DBind	235
15.11.4 Default constructor	236
15.11.5 Numerical ranges	237
15.12 Events	237
15.13 Keyboard buffer	238
15.14 File operations	238
15.15 Resource packs	240
15.16 Dates	240
15.17 Clocks	241

15.1. Core

Just as a building needs a strong foundation, any application or library must be based on robust and efficient pillars. It is useless to invest hours and hours in a nice interface if the internal engine is broken. For this purpose, the *core* library has been developed (Figure 15.1). Provides structures, utilities and algorithms commonly used in programming, which will facilitate the program development guaranteeing maximum efficiency and portability. *Core* is the third level within the NAppGUI SDK and still has no knowledge about the operating system graphics capabilities, so it can be used to implement any kind of project.

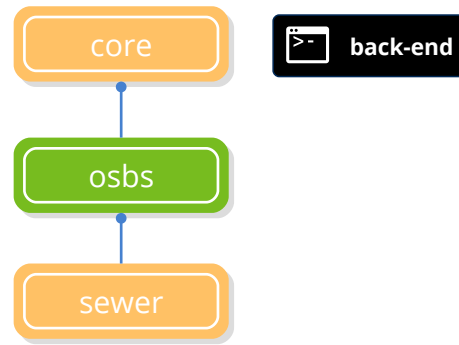

Figure 15.1: *core* dependencies. See “NAppGUI API” (page 151).

The services provided by *core* have been divided into several modules.

- “*Heap - Memory manager*” (page 196).
- “*Buffers*” (page 200).
- “*Strings*” (page 200).
- “*Streams*” (page 201).
- “*Arrays*” (page 215).
- “*Binary search trees*” (page 225).
- “*Regular expressions*” (page 230).
- “*Data binding*” (page 233).
- “*Events*” (page 237).
- “*File operations*” (page 238).
- “*Clocks*” (page 241).

15.2. Heap - Memory manager

Heap is a very efficient dynamic memory manager and auditor included in the *core* library and available for all projects based on NAppGUI (libraries and applications). It is common for applications to request a large number of small memory blocks to hold different objects (character strings, interface controls, structure instances, I/O buffer, etc). The strategy behind this manager is just to ask the operating system for memory pages of a certain size (64kb or more) using `bmem_malloc` and use them to solve several requests very efficiently.

- Use `heap_new` to dynamically create an object.
- Use `heap_malloc` to reserve a memory block.
- Use `heap_delete` to destroy an object.
- Use `heap_free` to free up a memory block.

```
Product *product = heap_new(Product);
byte_t *memblock = heap_malloc(1024, "MyOwnBlock");

// Do something
...

heap_delete(&product, Product);
heap_free(&memblock, "MyOwnBlock");
```

Using **Heap** instead of system calls will provide us with certain benefits:

- Performance: A call to `heap_malloc` is solved only by increasing the value of a counter. `heap_free` it only updates the header of the affected page.
- Locality: Two consecutive calls to `heap_malloc()` are located in contiguous physical memory positions. This reduces the number of cache failures because, according to the locality principle, there is a high probability that two objects that are created together will be used together.
- Memory leaks: *heap* points reservations and releases by object type. If necessary, will notify the programmer through “*Asserts*” (page 159) or “*Log*” (page 192) that there are objects not released. The great advantage of this auditor over other tools is that it is always being executed as part of the program. This exploits the temporal coherence, because if after a program change *leaks* are detected where there was not before, it is very likely that we can limit and detect the error, since it will be something we have just worked on.
- Statistics: We can obtain memory usage profiles (time/bytes). This can help us detect bottlenecks (especially at startup) or optimize page size.

15.2.1. Multi-thread memory

By default, *heap* is configured to work optimally in single-threaded applications. If we want several threads of the same process to reserve or release dynamic memory concurrently and safely, we must use:

- `heap_start_mt` to start multi-thread support.
- `heap_end_mt` to end multi-thread support.

The moment `heap_start_mt` is called, the synchronization mechanisms within the heap are activated to guarantee mutual exclusion to the memory manager until a call to `heap_end_mt` is received which will return to single-threaded operation mode. Successive calls to `heap_start_mt` will accumulate, so it will remain in multi-threaded mode until all open blocks are closed (Listing 15.1). It is the responsibility of the programmer to use this pair of functions at those points of the program that require it.

Any section that begins with `heap_start_mt` must be closed with `heap_end_mt`.

There is no problem in activating multi-threaded support in single-threaded sections, except for a slight performance penalty.

Listing 15.1: Multi-thread sections.

```
// Single-threaded block
...
...

heap_start_mt();
// Multi-threaded block
...
heap_start_mt();
...
heap_end_mt();
// Continue multi-threaded block
...
heap_end_mt();

// Single-threaded block
...
```

15.2.2. How Heap Works

When a program starts, *heap* creates a default memory page. The first bytes are reserved as a header, a small structure that controls the state of the page. Each request is assigned sequentially within the same page, increasing the value of a pointer (Figure 15.2). When

the page runs out of space, a new one is created `bmem_malloc`, which is linked to the previous one and labeled as the new **default page** (Figure 15.3). Each call to `heap_free` update the header with the number of blocks/bytes released (Figure 15.4). These blocks **are not reused**, otherwise the logic of `heap` would be complicated by slowing it down. The address of the header is stored at the end of each block, so do not have to iterate to locate it. When all the blocks on the page have been released, the entire page is destroyed by `bmem_free` and the pointers between neighboring pages restored (Figure 15.5).

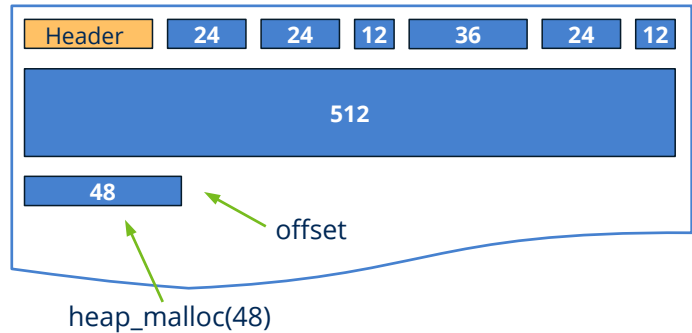

Figure 15.2: Reserve a new memory block with `heap_malloc()`.

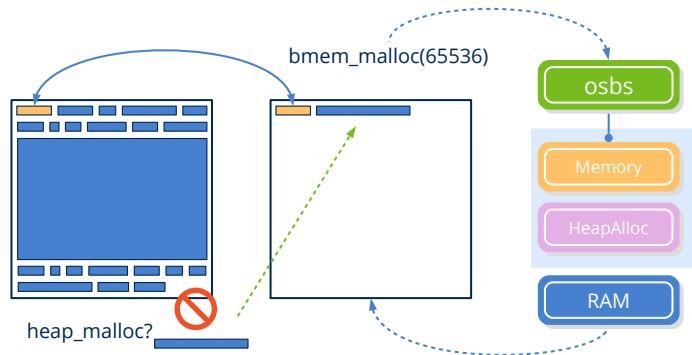

Figure 15.3: Request to the operating system of a new empty page.

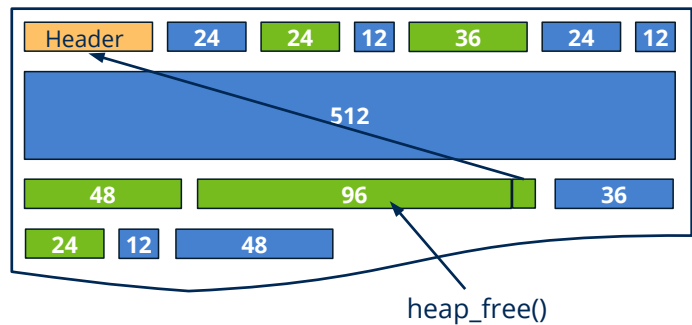

Figure 15.4: Releasing a block of memory (only updates the header).

Heap also counts the number of alloc/dealloc per object type using the parameter name of `heap_malloc`. At the end of the execution of the program, if the application lacks *memory leaks*, it will write in “Log” (page 192) a message like this:

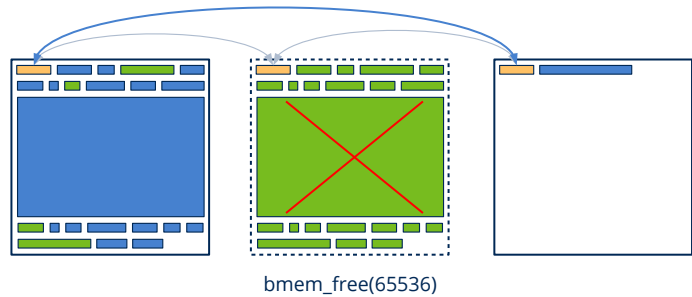

Figure 15.5: Destroying the entire page.

```
[12:58:08] [OK] Heap Memory Statistics
[12:58:08] =====
[12:58:08] Total a/dellocations: 1126, 1126
[12:58:08] Total bytes a/dellocated: 74611, 74611
[12:58:08] Max bytes allocated: 54939
[12:58:08] Effective reallocations: (0/34)
[12:58:08] Real allocations: 2 pages of 65536 bytes
[12:58:08] =====
```

But if after the execution, the application has memory to be released, the message will be different:

```
[13:00:35] [FAIL] Heap Object Leaks!!!
[13:00:35] =====
[13:00:35] 'App' a/deallocations: 1, 0 (1 leaks)
[13:00:35] 'String' a/deallocations: 414, 410 (4 leaks)
[13:00:35] =====
[13:00:35] [FAIL] Heap Global Memory Leaks!!!
[13:00:35] =====
[13:00:35] Total a/dellocations: 1161, 1156 (5 leaks)
[13:00:35] Total bytes a/dellocated: 75704, 75596 (108 bytes)
[13:00:35] Max bytes allocated: 54939
[13:00:35] =====
```

That warns that we have an object `App` and four `String` without releasing. If in the previous execution there were no *leaks*, it is very likely that we can narrow the error without too much difficulty.

The heap auditor does not intend to replace more advanced memory testing tools, it is only a first filter that constantly alerts us during the development and test phase. Although the overhead that occurs at runtime is minimal, the auditor is completely disabled in the Release configuration.

15.3. Buffers

Buffer objects are simply dynamically stored memory blocks and stored in the “*Heap Segment*” (page 170). They are useful for sharing generic data between different functions or threads. For the latter case, they must be protected by a `Mutex` if several threads can access it concurrently (they are not *thread-safe*). They are of fixed size. Once created, they can not be resized, although they can be rewritten as many times as necessary.

- Use `buffer_create` to create a dynamic memory block.
- Use `buffer_destroy` to free up a block of dynamic memory.
- Use `buffer_data` to get a pointer to the memory block.

15.4. Strings

`String` objects contain “*UTF-8*” (page 164) characters strings dynamically allocated. Although it is possible to insert static text strings directly into the source code or access them through the resource packages (`respack_text`), it is usually necessary to compose texts at runtime or dynamically store strings received by some input channel (keyboard, files, network, etc). The NAppGUI `strings.h` module offers a multitude of functions to work with UTF8 text strings, both static and dynamic.

- Use `str_c` to create a dynamic copy of a static C string.
- Use `str_printf` to compose a dynamic string using the same format as C `printf`.
- Use `tc` to get a `const char_t*` pointer to the content of a `String`.

```
String *str1 = str_c("This a static char array.");
String *str2 = str_printf("Code: %s, Price %8.2f.", tc(product->code),
    ↪ product->price);
const char_t *cstr1 = tc(str1);
const char_t *cstr2 = tc(str2);
cstr1 = "This a static char array."
cstr2 = "Code: 456-34GH-JKL, Price 439.67."
```

*Do not confuse `String` objects with C strings `const char_t *str` or `char_t str [128]`. The first ones contain a pointer to the dynamic memory area and an integer with the number of reserved bytes.*

In the case that it is necessary to create more extensive texts from loops, the most efficient way is to create a `Stream` and, later, obtain the associated `String`.

```
String *str = NULL;
Stream *stm = stm_memory(2048);
uint32_t n = arrpt_size(products, Product);
```

```

stm_printf(stm, "List of %d products\n", n);
arrpt_foreach(product, products, Product);
    stm_printf(stm, "Code: %s, Price %8.2f.\n", tc(product->code), product->
        ↪ price);
arrpt_end()
str = stm_str(stm);
stm_close(&stm);

// Do something with 'str'
...

str_destroy(&str);

```

15.5. Streams

A *stream* is a data flow that runs from a source to a destination. Think of a phone call. We have an origin (the person who speaks), a destination (the person who listens) and a channel (the line itself). In programming, the stream is the equivalent to the telephone line, it is the pipe that joins the application with a data source or destination (Figure 15.6) and through which binary information, bit sequences, run. As with any other communication channel, the information is volatile, available for a very limited time. Once it reaches the receiver, it disappears.

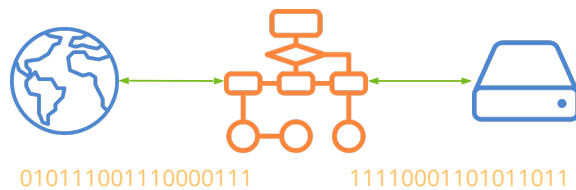

Figure 15.6: Streams connect the process with the machine and the world.

In essence, there are three elementary operations to perform when working with streams: Create the channel, read data and write data.

- Use `stm_memory` to create a read/write memory stream.
- Use `stm_read_r32` to read a `float` from the stream.
- Use `stm_write_r32` to write a `float` to the stream.
- Use `stm_close` to close the channel and free up resources (destructor).

15.5.1. Stream Types

Actually, it is more correct to talk about types of extremes (origin and destination) than of stream types. From the perspective of the programmer, a stream is an abstract type that presents the same functionality regardless of the ends it connects. Therefore, when talking about *stream types* we are referring to the type of constructor.

15.5.2. File stream

In *File streams* (Figure 15.7), the source is the process memory and the destination is a disk file. The opposite can also happen: that the source is the file and the destination the memory, it will depend on how we create the channel. It will not be possible to perform write operations on an open file for reading or vice versa (Listing 15.2). “*Files and directories*” (page 185).

Figure 15.7: *File streams* allow communication with the file system.

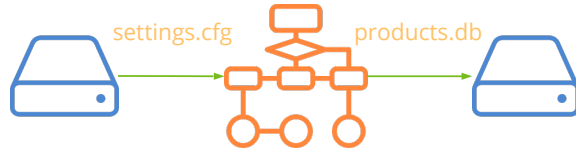

- Use `stm_from_file` to open a file and read from it.
- Use `stm_to_file` to create a file and write to it.
- Use `stm_append_file` to add content to an existing file.

Listing 15.2: Example of writing to a file.

```
Stream *stm = stm_to_file("C:\\Users\\user\\john\\out.txt", NULL);
if (stm != NULL)
{
    stm_writef(stm, "One ");
    stm_writef(stm, "Two ");
    stm_writef(stm, "Three");
    stm_writef(stm, ".");
    stm_close(&stm);
    // 'out.txt' is closed = "One Two Three."
}
```

15.5.3. Socket stream

A *socket* is a communication channel between two processes over the Internet (Figure 15.8). Unlike *file streams*, sockets allow bidirectional *full-duplex* communication, that is, both ends can send and receive information. The sequence of message exchange between partners is determined by the protocol (Listing 15.3), being HTTP, FTP, SMTP or LDAP some of the most used for Internet transmissions. See “*Sockets*” (page 187).

Figure 15.8: A *socket stream* opens a communication channel over the Internet.



- Use `stm_socket` to create a communication channel with a remote process.

Listing 15.3: Downloading a web page, using the HTTP protocol.

```

uint32_t ip = bsocket_url_ip("www.myserver.com", NULL);
Socket *socket = bsocket_connect(ip, 80, 0, NULL);
if (socket != NULL)
{
    Stream *stm = stm_socket(socket);
    stm_writeln(stm, "GET /mypage.html HTTP/1.1\r\n");
    stm_writeln(stm, "Host: www.myserver.com\r\n");
    stm_writeln(stm, "\r\n");
    stm_lines(line, stm)
        bstd_printf(line);
        bstd_printf("\n");
    stm_next(line, stm)

    // Socket will be closed too
    stm_close(&stm);
}

```

15.5.4. Block stream

Block streams are used to read formatted data from a generic memory block. (Figure 15.9). This memory area is considered read-only and will not be modified, so write operations will not be allowed in this type of stream. When the end of the block is reached, the `ekSTEND` state will be activated.

- Use `stm_from_block` to read data from a memory block.

Figure 15.9: With *block streams* we will read formatted data from memory areas.

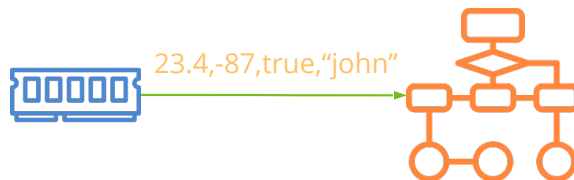

15.5.5. Memory stream

Memory streams are read/write channels that allow implementing the producer/consumer model (Figure 15.10). First, the information reaches the stream through write operations and is stored in an internal memory buffer. Subsequently, said information can be read by another function, thread or process. After each reading the information read will disappear from the channel. The concept is similar to that of IPC-pipes, except that there is no size limit for the buffer, but it will grow on demand. Read and write operations can be done simultaneously depending on the established protocol.

- Use `stm_memory` to create a stream in memory.
- Use `stm_buffer` to access the internal buffer.

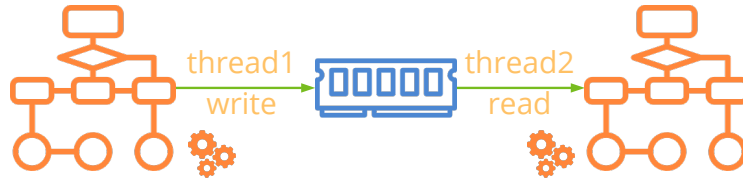

Figure 15.10: Producer/consumer model implemented with *memory streams*.

Although this type of stream supports read and write operations it is not considered full-duplex. The reading is done on previously written data, but cannot “answer” the interlocutor. It is not a “conversation”.

15.5.6. Standard stream

The “*Standard I/O*” (page 168) can be managed by *streams* using three predefined objects (Figure 15.11). These objects are created when the program starts and will be automatically released when finished.

- `kSTDIN`: To read from the standard input.
- `kSTDOUT`: To write in standard output.
- `kSTDERR`: To write in the error output.

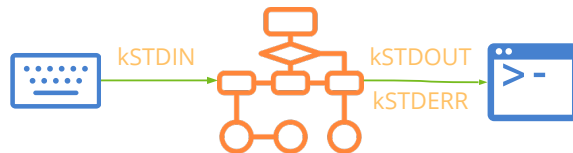

Figure 15.11: Access to standard I/O through streams.

```
real64_t value;
const char_t *line;
value = stm_read_r64(kSTDIN);
line = stm_read_line(kSTDIN);
stm_printf(kSTDOUT, "Value = %.4f", value);
```

15.5.7. Null stream

Sometimes it can be useful to have a “sink” that ignores all write operations (Figure 15.12). Think of debugging tasks where we want to activate or deactivate the output of information but deleting or commenting on the code is cumbersome. The idea is similar to the Unix `/dev/null`.

- Use `kDEVNULL` to write to a sink that will ignore all received data.

Figure 15.12: With *null streams* everything that is written will be ignored.



```
#if defined __ASSERTS__
Stream *stm = kSTDOUT;
#else
Stream *stm = kDEVNULL;
#endif

...
i_large_dump_func(obj1, stm);
...
// More debug functions
stm_printf(stm, "More debug data...\n");
...
i_other_dump_func(obj2, stm);
```

Cannot read from kDEVNULL.

15.5.8. Binary stream

Generic binary data always travels through a stream as bytes. How these data are interpreted depends on the interlocutors and their communication protocol. But by emphasizing “binary data” we mean that numeric values are written to the channel as they appear in the CPU registers using binary, two’s complement, or IEEE754 (Figure 15.13) code. In multi-byte types we must take into account the “*Byte order*” (page 213). In `stream.h` several functions are defined to read and write binary types.

- Use `stm_read_u32` to read a 32-bit unsigned integer.
- Use `stm_write_r64` to write a real 64bits (double).
- Use `stm_write_bool` to write a boolean.

Figure 15.13: Numbers in binary format.



15.5.9. Text stream

Text streams are a particular case where the binary information is assumed to represent Unicode character codes (*codepoints*) (Figure 15.14) (Listing 15.4). This means that the content of the stream will be readable directly by a human, but it will require a post-processing (*parsing*) in destination to interpret these texts and translate them into binary. You do not have to do anything special when creating a stream to indicate that it is of type text, you just have to use the appropriate functions.

- Use `stm_printf` to write text in a stream.
- Use `stm_read_char` to read a character from a stream.
- Use `stm_read_line` to read a text line from a stream.
- Use `stm_col` to get the column number of the last character read.
- Use `stm_row` to get the row number of the last character read.

Figure 15.14: In text streams the information can be read directly.



Listing 15.4: Reading a text file using streams.

```
Stream *stm = stm_from_file("/home/fran/Desktop/text.txt", NULL);
const char_t *line = stm_read_line(stm);
while(line != NULL)
{
    // Do something with 'line'
    textview_writeln(text, line);
    textview_writeln(text, "\n");

    // Read next line
    line = stm_read_line(stm);
}

stm_close(&stm);
```

`stm_read_line` and other reading functions will always return the text in UTF8. But if the data inside the stream were in another format, we must use `stm_set_read_utf`, in order to carry out the conversion correctly. See “*UTF encodings*” (page 163).

On the other hand, `stm_printf` also receives the text in UTF8, but the receiver may need it in another format. We will use `stm_set_write_utf` to set the output encoding. We will write in UTF8, but the channel will be sent in UTF16 or UTF32.

Streams do not have to be “pure” text or binary. They can combine both types of representations.

15.5.10. Tokens

When reading from text streams, an interpretation (*parsing*) of the content is necessary in order to transfer the data to memory variables (in binary). The first step is to break the text into symbols (or words) called *tokens*. Internally, the streams incorporate a simple **lexical analyzer** that recognizes the tokens of the C language, very common in countless grammars and file formats (Figure 15.15). It is implemented as a finite state machine and will greatly facilitate the processing of these text flows. In (Listing 15.5) we see the code necessary to read one by one all the tokens from a `.c` file. We have the result of processing the file (Listing 15.6) in (Listing 15.7).

- Use `stm_read_token` to read a token.
- Use `stm_token_lexeme` to obtain the string associated with the last token read.
- Use `stm_read_r64_tok` to read a `real64_t` from text.
- Use `stm_token_col` to get the column of the last token.
- Use `stm_token_row` to get the row of the last token.

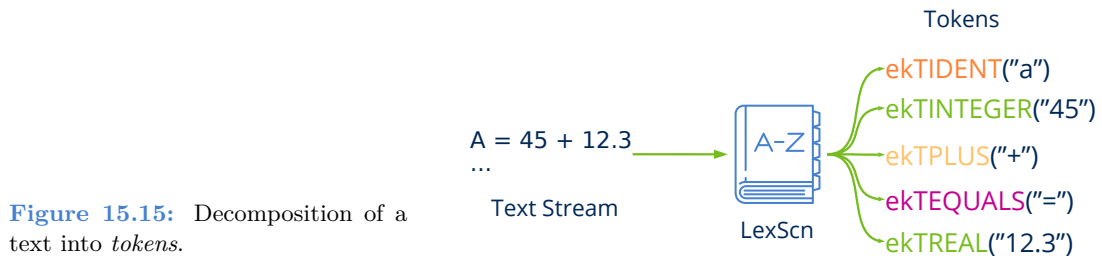

Listing 15.5: Reading *tokens* from a file in C.

```
Stream *stm = stm_from_file("source.c", NULL);
token_t token;

while ((token = stm_read_token(lex)) != ekTEOF)
{
    switch (token) {
        case ekTIDENT:
            // It's an IDENTIFIER
            ...

        case ekTREAL:
            // It's a REAL NUMBER
            ...
    }
}
```

Listing 15.6: File *source.c*.

```

void func(int a)
{
    int i;
    char *str = "Hello";

    i = 5 + 2.5;
}

```

Listing 15.7: Lexical analysis of *source.c*.

Token	Lexeme
-----	-----
ekTIDENT	"void"
ekTIDENT	"func"
ekTOPENPAR	"("
ekTIDENT	"int"
ekTIDENT	"a"
ekTCLOSPAR	")"
ekTOPENCURL	"{"
ekTIDENT	"int"
ekTIDENT	"i"
ekTSCOLON	","
ekTIDENT	"char"
ekTASTERK	"*"
ekTIDENT	"str"
ekTEQUALS	"="
ekTSTRING	"\"Hello\""
ekTSCOLON	","
ekTIDENT	"i"
ekTEQUALS	"="
ekTINTEGER	"5"
ekTPLUS	"+"
ekTREAL	"2.5"
ekTSCOLON	","

15.5.11. Identifiers

An identifier is an alphanumeric “word” that must begin with a letter or ‘_’ and contains numbers, letters, or ‘_’. It is used to name variables, functions, reserved words, etc. They do not allow spaces or symbols. (Listing 15.8) (Figure 15.16).

Listing 15.8: Correct and incorrect identifiers.

```

OK: while cos _reSult a56B _06_t aG h9 _12AcVb
NO: 045 ?er "_5G _tg(

```

Certain identifiers can be reserved to act as language **keywords**. For example `for`, `while` or `if` are C keywords and cannot be used for the naming of variables or functions.

Figure 15.16: Finite automata that recognizes an identifier.

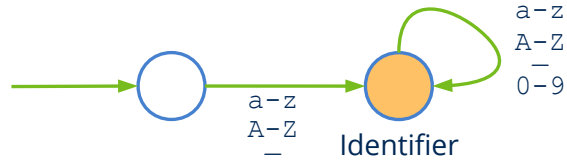

Being general purpose, our scanner does not recognize any type of reserved word, but must be expressly tagged after reading the token (Listing 15.9).

Listing 15.9: Recognizing the **while** keyword.

```
while ((token = stm_read_token(stm)) != ekTEOF)
{
    if (token == ekTIDENT)
    {
        const char_t *lex = stm_token_lexeme(stm, NULL);

        if (str_equ_c(lex, "while") == TRUE)
            token = ekTRESERVED;
    }
}
```

15.5.12. Strings

A text string is a series of Unicode characters enclosed in quotation marks (") (Figure 15.17). The parser recognizes C escape sequences to represent non-printable codes or unavailable characters on the keyboard (Listing 15.10).

- Use `stm_token_escapes` to make escape sequences effective when reading strings.

Listing 15.10: Escape sequences accepted in `ektSTRING`.

<code>\a</code>	07	Alert (Beep, Bell) (added in C89)
<code>\b</code>	08	Backspace
<code>\f</code>	0C	Formfeed Page Break
<code>\n</code>	0A	Newline (Line Feed)
<code>\r</code>	0D	Carriage Return
<code>\t</code>	09	Horizontal Tab
<code>\v</code>	0B	Vertical Tab
<code>\\</code>	5C	Backslash
<code>\'</code>	27	Single quotation mark
<code>\"</code>	22	Double quotation mark
<code>\?</code>	3F	Question mark (used to avoid trigraphs)
<code>\nnn</code>		Octal number
<code>\xhh</code>		Hexadecimal number
<code>\Uhhhhhhh</code>		Unicode code point
<code>\uhhhh</code>		Unicode code point

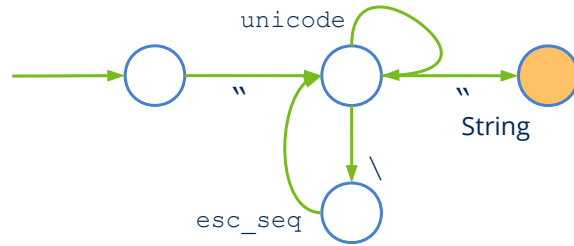

Figure 15.17: Finite automata that recognizes a text string.

15.5.13. Numbers

In the case of numerical *tokens* the thing is complicated a bit due to the different numerical bases and the exponential representation of real numbers (Figure 15.18). We briefly summarize it, although it is common to many programming languages (C included).

- If the number starts with 0 it will be considered octal (base 8), therefore, the following digits are limited to 0-7, eg: 043, 001, 0777.
- If the number starts with 0x will be considered hexadecimal (base 16) with digits 0-9 a-f A-F, eg: 0x4F, 0XAA5, 0x01EAC.
- At the moment a decimal point appears '.' will be considered real number. A point at starting is valid, eg: .56.
- An integer or real number allows exponential notation with the character 'e' ('E'), eg: 12.4e2, .56e3, 1e4.

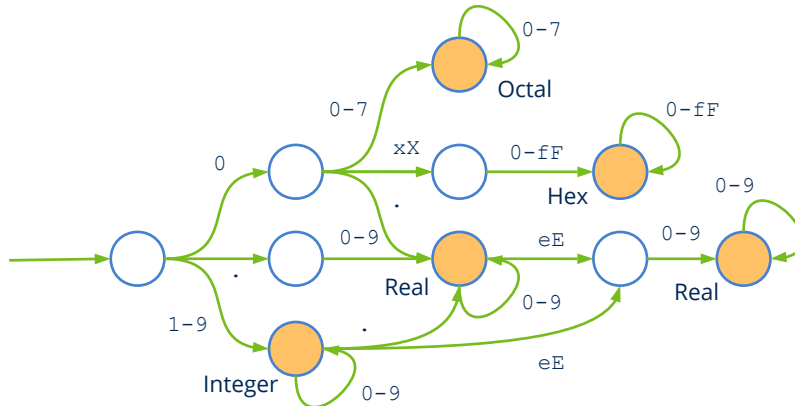

Figure 15.18: Finite automata that recognizes numbers.

15.5.14. Symbols

The symbols are single-character *tokens* that represent almost all US-ASCII punctuation marks and are often used as operators, separators or limiters within grammars. (Listing 15.11) (Figure 15.19).

Listing 15.11: Symbols recognized as *tokens* by `LexScn`.

```
< > , . ; : ( ) [ ] { } + - * = $ % # & ' " ^ ! ? | / \ @
```

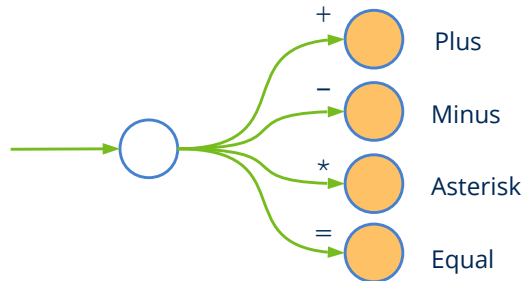
**Figure 15.19:** Finite automata that recognizes some symbols.

15.5.15. Comments

By default, C `/*Comment */` or C++ `//Comment` are ignored by `stm_read_token`.

- Use `stm_token_comments` so that it returns `ekTSLCOM` or `ekTMLCOM` if it finds any.
- Use `stm_token_spaces` to return `ekTSPACE` when it finds blank spaces.

15.5.16. Stream advantages

Although it is possible to read or write directly to the I/O channels (“*Memory*” (page 169), “*Files and directories*” (page 185), “*Sockets*” (page 187), “*Standard I/O*” (page 168)), do it through `Stream` objects has certain advantages. Therefore, we recommend using them instead of low-level APIs for the following reasons:

15.5.17. Unify serialization

Streams offer a uniform interface, regardless of the origin and destination of the data (Figure 15.20). For the object serialization, we just have to write a reader and a writer, without worrying if the object will be saved to disk, transmitted over the Internet or stored temporarily in memory (Listing 15.12).

Listing 15.12: (De)serialization of an object through streams.

```
typedef struct _product_t
{
    type_t type;
    String *code;
    String *description;
    Image *image64;
    real32_t price;
} Product;

void product_write(Stream *stm, Product *product)
```

```

{
    stm_write_enum(stm, product->type, type_t);
    str_write(stm, product->code);
    str_write(stm, product->description);
    image_write(stm, product->image64);
    stm_write_r32(stm, product->price);
}

void product_read(Stream *stm, Product *product)
{
    product->type = stm_read_enum(stm, type_t);
    product->code = str_read(stm);
    product->description = str_read(stm);
    product->image64 = image_read(stm);
    product->price = stm_read_r32(stm);
}

```

Figure 15.20: Through streams we manage all I/O channels with the same interface.

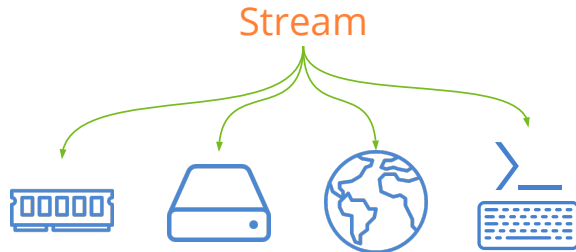

15.5.18. More elegance

The I/O channels only work with byte blocks. Streams implement high-level functions for texts and binary types. This will make our code much more readable. (Listing 15.13).

Listing 15.13: Writing an object to disk directly or through a stream.

```

void product_write(File *file, Product *product)
{
    uint32_t size = str_len(product->description);
    const char_t *data = tc(product->description);
    bfile_write(file, (byte_t*)&product->id, sizeof(uint32_t), NULL, NULL);
    bfile_write(file, (byte_t*)&product->price, sizeof(real64_t), NULL, NULL);
    bfile_write(file, (byte_t*)&size, sizeof(uint32_t), NULL, NULL);
    bfile_write(file, (byte_t*)data, size, NULL, NULL);
}

void product_write(Stream *stream, Product *product)
{
    stm_write_u32(stream, product->id);
    stm_write_r64(stream, product->price);
    str_write(stream, product->description);
}

```

15.5.19. Higher productivity

Related to the previous one, streams can “parse” text strings directly. You can get characters, words or lines without having to scan the entry character by character (Listing 15.14).

Listing 15.14: Read a line of text directly or through a stream.

```
String *getline(File *file)
{
    /* Potentially unsafe. */
    /* Risk of buffer overflow. */
    char_t buffer[MAXBUFF];
    uint32_t i = 0;
    char_t c;

    bfile_read(file, (byte_t*)&c, 1, NULL, NULL);
    while (c != '\n')
    {
        buffer[i] = c;
        i += 1;
        bfile_read(file, (byte_t*)&c, 1, NULL, NULL);
    }

    buffer[i] = '\0';
    return str_c(buffer);
}

String *getline(Stream *stream)
{
    /* Totally safe. */
    /* 'line' is managed by dynamic cache. */
    const char_t *line = stm_read_line(stream);
    return str_c(line);
}
```

15.5.20. Higher performance

File streams and *socket streams* implement an internal cache. This allows less access to the channel with a higher volume of data, which means faster processing speed. (Figure 15.21).

- Use `stm_flush` to clear the cache and dump the data in the channel.

15.5.21. Byte order

When reading or writing binary data from an I/O channel, special attention must be paid to the order of the bytes in 16, 32 or 64 bit data types, which is known as *endianness*. On *little endian* machines, as is the case with the Intel x86/x64 family processors, the

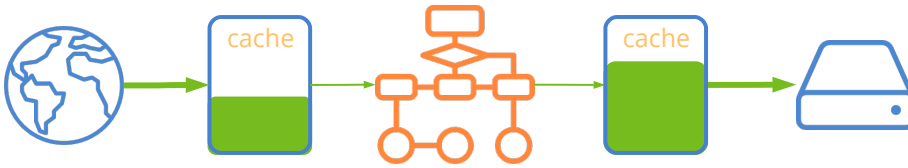

Figure 15.21: Streams implement cache memory, which increases performance.

lowest order byte will be located at the lowest memory address. In the case of the *big endian* (Motorola 68000, PowerPC) it happens on the contrary, it will go in the highest. For example, if we write a 32-bit integer in a file or *socket* from a *little endian* machine and read it from a *big endian*, the data will be corrupted by altering the internal order of bits (Figure 15.22). The `Stream` objects automatically adjust the *endianness* in each read/write operation. Default is set `ekLITEND`, except in *sockets* that will be `ekBIGEND` for being the accepted agreement for network communications. However, it can be changed if necessary.

- Use `stm_set_write_endian` to establish the *endianness* of the output channel. The data will pass from *endian CPU* to *Stream endian* before being written.
- Use `stm_set_read_endian` to establish the *endianness* of the input channel. The data will pass from *Stream endian* to *CPU endian* at the time of being read.



Figure 15.22: We must take into account *endianness* when sharing data between machines of different architecture.

Endianness does not influence “UTF-8” (page 164) text strings, but it does in the “UTF-16” (page 163) and “UTF-32” (page 163).

15.5.22. Stream state

A stream can be affected by two types of problems. On the one hand the **data corruption** that is evident when we read binary data from the stream. A clear example would be to read a Boolean by `stm_read_bool` and get a value of 129 when obviously this value should be 0 (`TRUE`) or 1 (`FALSE`). Typically, a stream becomes corrupted due to lack of coordination between writer and reader and is usually due to a programming error. This situation should be resolved by debugging and correcting the serialization of objects or reviewing the data protocol. On the other hand, there may be “physical” errors

in the channel (file deleted, loss of Internet connection, permissions, etc.). In both cases, the stream will be blocked and subsequent read or write operations that we carry out on it will be ignored. We can also ask the total number of bytes read and/or written in the channel, in case we need to know if there is information available for reading.

- Use `stm_state` to know the current status of the channel.
- Use `stm_file_err` to get extended error information on disk streams.
- Use `stm_sock_err` to get extended error information in *sockets*.
- Use `stm_corrupt` to mark a stream as `ekSTCORRUPT`. Sometimes it is the application itself that detects that the data is not correct (eg out of range).
- Use `stm_bytes_written` to get the total number of bytes written to the stream.
- Use `stm_bytes_readed` to get the total number of bytes read from the stream.

```
uint32_t nw = stm_bytes_written(stm);
uint32_t nr = stm_bytes_readed(stm);
if (nw - nr > 0)
{
    if (stm_state(stm) == ekSTOK)
    {
        uint32_t v1 = stm_read_u32(stm);
        real32_t v2 = stm_read_r32(stm);
        ...
    }
    else
    {
        // Error in stream
    }
}
else
{
    // No data in stream
}
```

15.6. Arrays

Being able to work with data collections is essential when designing our model. In addition to the basic types and the `struct`, `union` or `class`, the C language offers us the *array* construction, which allows to store several elements under the same variable name (Listing 15.15):

Listing 15.15: C Arrays.

```
typedef struct _product_t Product;
struct _product_t
```



```

{
    type_t type;
    String *code;
    String *description;
    Image *image64;
    real32_t price;
};

DeclSt(Product);
DeclPt(Product);

uint32_t integers[100];
real32_t reals[100];
Product products[100];

```

Or, dynamically (Listing 15.16):

Listing 15.16: Dynamic arrays.

```

uint32_t n = get_n();
uint32_t *integers = heap_new_n(n, uint32_t);
real32_t *reals = heap_new_n(n, real32_t);
Product *products = heap_new_n(n, Product);

```

The **C arrays** store elements in contiguous positions of memory and, although they are very quick to consult, they lack the functionality to insert, delete, search or sort. In many cases, the data is not available when the container is created, but they are entering or leaving dynamically during the program execution, so we cannot anticipate in advance a maximum number with which to make the memory reservation. The `Array` type implemented in `NAppGUI` is, in essence, a dynamic C array and a series of methods to manipulate it. By dynamic we understand that the structure adjusts its size to the actual amount of elements, keeping the main premise that **all remain in memory together**.

When an `Array` is created, memory is reserved for a few records (Figure 15.23). Later, we can add new elements at the end (typical) or insert them in any random position in case we already have data in the container. In the latter case, the rest of the elements will be shifted to the right. As soon as the number of reserved records is exceeded, the internal dynamic block will be doubled to accommodate the new positions. In the same way it is possible to eliminate any element of the collection, moving the rest to the left to maintain the spatial coherence of the structure. If the number of items decreases by half, the memory block will be reduced. In this way, during the life of the container, the memory will be adjusted by multiplying or dividing by 2 the number of reserved elements.

15.6.1. Registers or pointers

An object of type `Product`, our example structure, needs 20 bytes on 32-bit systems (Figure 15.24). The `code`, `description` and `image64` fields are pointers that point to

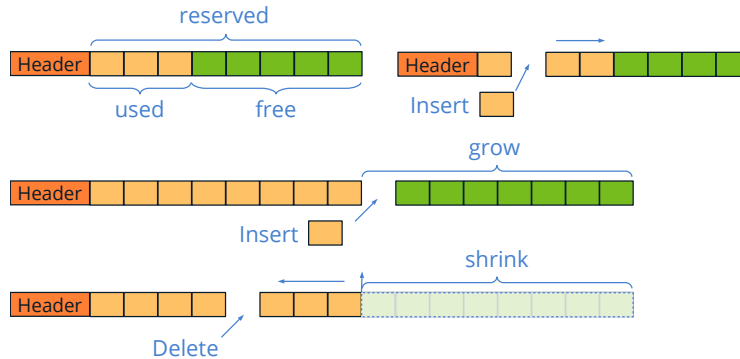

Figure 15.23: The Array adapt their internal memory to the number of elements.

other memory areas, where the `String` and `Image` type fields reside, dynamically reserved.

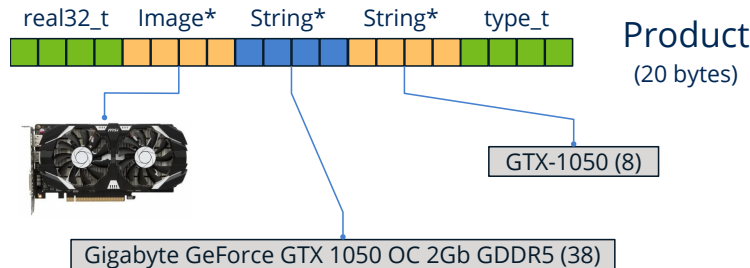

Figure 15.24: Product object.

Depending on what is stored inside the container, we can use two kinds of array (Listing 15.17). The array of records will keep the entire object (20 bytes) inside and the array of pointers only a reference to it (4 bytes), the actual object being located in another memory address (Figure 15.25). Although the internal structure management is the same, access to the elements differs slightly.

- Use `arrst_create` to create an array of records.
- Use `arrpt_create` to create an array of pointers.

Listing 15.17: Create an array.

```
ArrSt(Product) *arrst = arrst_create(Product);
ArrPt(Product) *arrpt = arrpt_create(Product);
```

Use `ArrSt` can slightly improve performance, thanks to spatial consistency, which reduces cache failures, and saving calls to the memory manager “*Arrays vs Sets comparative*” (page 228). But this will not always be possible, and we cannot use them in these cases:

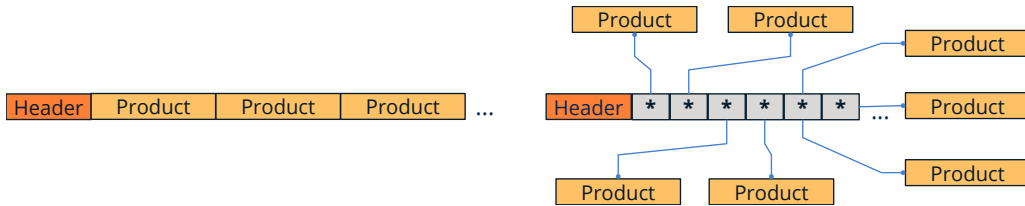

Figure 15.25: Arrays of registers and pointers.

- Opaque objects: If the type definition is not public, the container cannot calculate the space required for each element, so we can only work with pointers to them.
- Shared objects: If other structures of the model keep pointers to the elements of the container, we will have *Segmentation Fault* problems due to the change of memory addresses when relocating the internal container block (Figure 15.26).

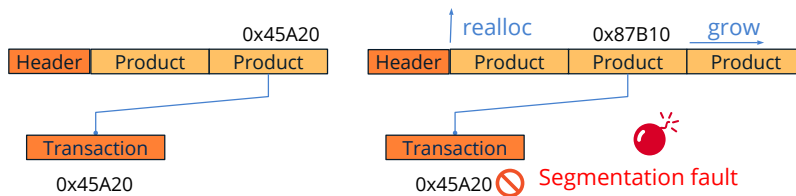

Figure 15.26: Register arrays are dangerous with external references.

15.6.2. Type check

You will have noticed in (Listing 15.15) that two statements appear just after the definition of the struct `Product`: `DeclSt` and `DeclPt`. These are two macros that enable compile-time type checking, defining a custom interface in the containers for this new type (Listing 15.6.2). All things considered, they mimic the C++ `template<>`. `DeclSt` enables record containers and `DeclPt` pointer ones.

```
Product *p1 = arrst_new(Product);
Product *p2 = arrst_get(arrst, 5, Product);
const Product *p3 = arrst_get_const(arrst, 5, Product);
```

Although it is not advisable, you can dispense with the use of these macros and use the “raw” interfaces of the containers, defined in `array.h` and `rbtree.h`. In this case your code will be much less readable and you will not have compiler support.

Headers `array.h` and `rbtree.h` are not documented.

15.6.3. Constructors

When memory is reserved for an object, either in the “*Stack Segment*” (page 169) as **automatic variables**

```
Product product;
```

at “*Heap Segment*” (page 170) through dynamic memory

```
Product *product = heap_new(Product);
```

or in a container

```
Product *product = arrst_new(array, Product);
```

its initial content is garbage, understood as undetermined bytes. Initializing an object is assigning valid and consistent values to each field of the object (Listing 15.18).

Listing 15.18: Initializing an object Product.

```
static void i_init(Product *product)
{
    product->type = ekCPU;
    product->code = str_c("");
    product->description = str_c("");
    product->image64 = image_copy(gui_image(NOIMAGE_PNG));
    product->price = 0.f;
}
```

For its part, a constructor is an initializer that previously reserves memory dynamically to store the object (Listing 15.19).

Listing 15.19: Constructor of object Product.

```
static Product *i_create(void)
{
    Product *product = heap_new(Product);
    i_init(product);
    return product;
}
```

When we use register arrays, we will only need to initialize the object, since the space to store it has been reserved by the container itself (Listing 15.20). However, in pointer arrays, the memory for the object must be explicitly reserved, since the container will only save a reference.

Listing 15.20: Insert correctly initialized objects.

```
// Add an item using an automatic variable (a copy is required)
Product product;
```

```

i_init(&product);
arrst_append(array, product, Product);

// Add an item directly (avoiding copying)
Product *product = arrst_new(array, Product);
i_init(product);

// Add a pointer to a newly created object on the heap
Product *product = i_create();
arrst_append(array, product, Product);

```

Use `arrst_new`, `arrst_insert_n` or `arrst_prepend_n` whenever possible to insert into record arrays, as they avoid having to copy the object.

15.6.4. Array loops

To iterate over all the elements of the array, we can choose between two types of syntax to implement the loop.

```

uint32_t i, n = arrst_size(arrst, Product);
for (i = 0; i < n; ++i)
{
    const Product *product = arrst_get(arrst, i, Product);

    // Do something
    ...
}

arrst_foreach(product, arrst, Product)
    // Do something
    ...
arrst_end()

// In reverse order
arrst_foreach_rev(product, arrst, Product)
    // Do something
    ...
arrst_end()

```

15.6.5. Copy objects

Similar to constructors, there are two methods for copying objects (Listing 15.21). In the first one, we generate dynamic memory for the object's fields, but not for the object itself, either because it is an automatic variable or is stored in an array of records. In the second case, we reserve dynamic memory for both the object and its elements.

Listing 15.21: Copying an object `Product`.

```

static void i_copy_data(Product *dest, const Product *src)
{
    dest->type = src->type;
    dest->code = str_copy(src->code);
    dest->description = str_copy(src->description);
    dest->image64 = image_copy(src->image64);
    dest->price = src->price;
}

static Product *i_copy(const Product *product)
{
    Product *new_product = heap_new(Product);
    i_copy_data(new_product, product);
    return new_product;
}

ArrSt(Product) *arrst = arrst_copy(arrst_src, i_copy_data, Product);
ArrPt(Product) *arrpt = arrpt_copy(arrpt_src, i_copy, Product);

```

15.6.6. Serialization

A special case of the constructor are the **readers** (de-serializers). When we create an array from the content of “Streams” (page 201) (Listing 15.22), we need a method capable of creating or initializing an element from the stream itself. Depending on the type of container it will be necessary to reserve memory for each item or not.

Listing 15.22: Reading an array from a stream.

```

static void i_read_data(Stream *stm, Product *product)
{
    product->type = stm_read_enum(stm, type_t);
    product->code = str_read(stm);
    product->description = str_read(stm);
    product->image64 = image_read(stm);
    product->price = stm_read_r32(stm);
}

static Product *i_read(Stream *stream)
{
    Product *product = heap_new(Product);
    i_read_data(stream, product);
    return product;
}

ArrSt(Product) *arrst = arrst_read(i_read_data, Product);
ArrPt(Product) *arrpt = arrpt_read(i_read, Product);

```

In the same way we can write (serialize) the contents of an array in a write stream (Listing 15.23). In this case, a single write function is sufficient for both types of containers,

since each one knows how to access its elements.

Listing 15.23: Writing an array in a stream.

```
static void i_write(Stream *stm, const Product *product)
{
    stm_write_enum(stm, product->type, type_t);
    str_write(stm, product->code);
    str_write(stm, product->description);
    image_write(stm, product->image64);
    stm_write_r32(stm, product->price);
}

arrst_write(stm, arrst, i_write, Product);
arrpt_write(stm, arrpt, i_write, Product);
```

15.6.7. Destructors

In programming many times we are confused by the verbs: *'delete'*, *'destroy'*, *'free'*, *'erase'*, *'remove'*, *'clear'* since they essentially mean the same thing but with subtle differences. In NAppGUI we will use one verb or another depending on concrete actions:

- **Free:** Only free dynamic memory allocated to an object (Listing 15.24). You need a double pointer, since the object will be invalidated (`=NULL`) after freeing it, avoiding references to free memory areas.

Listing 15.24: Freeing the memory of an object.

```
Product *product = heap_new(Product);
...
heap_free(&product, Product);
// product = NULL
```

- **Remove:** It destroys the fields of an object, but does not free the memory of the object itself. It is the opposite of the *initializer* (Listing 15.25).

Listing 15.25: Freeing memory from object fields.

```
static void i_remove(Product *product)
{
    str_destroy(&product->code);
    str_destroy(&product->description);
    image_destroy(&product->image64);
}

arrst_destroy(&arrst, i_remove, Product);
```

- **Destroy:** The combination of the previous two. Destroy the fields of the object and free its memory (Listing 15.26). It is the opposite of the constructor. Obviously, it requires a double pointer to invalidate the reference.

Listing 15.26: Free the object’s memory and all its contents.

```
static void i_destroy(Product **product)
{
    i_remove(*product);
    heap_free(product, Product);
}

arrpt_destroy(&arrpt, i_destroy, Product);
```

- **Delete:** Delete an element from an array or other type of container (Listing 15.27). It may have associated a destructor or remover, although it is not mandatory.

Listing 15.27: Delete an item from a container.

```
// Just delete.
arrst_delete(arrst, 4, NULL, Product);

// Delete and remove (arrst).
arrst_delete(arrst, 4, i_remove, Product);

// Delete and destroy (arrpt).
arrpt_delete(arrpt, 4, i_destroy, Product);
```

- **Clear:** Delete all the elements of a container, but do not destroy it, just leave it to zero (Listing 15.28). Like `arrst_delete`, optionally can free objects memory.

Listing 15.28: Clear a container, deleting all its items.

```
// Just delete all.
arrst_clear(arrst, NULL, Product);

// Delete and remove all (arrst).
arrst_clear(arrst, i_remove, Product);

// Delete and destroy all (arrpt).
arrpt_clear(arrpt, i_destroy, Product);
```

15.6.8. Sort and search

The usual way to use arrays will be to add elements at the end by `arrst_new` or `arrpt_append` then iterate over all. This “natural” order will be enough in most cases, but we may need to organize the elements following another criterion for:

- Present the information ordered by one or several fields of the structure.
- Optimize searches. To locate a certain element, there is no choice but to travel the entire array, with linear cost $O(n)$. But we can solve the search in logarithmic time $O(\log n)$ if the array is sorted, dramatically increasing performance especially in large sets (Figure 15.27).

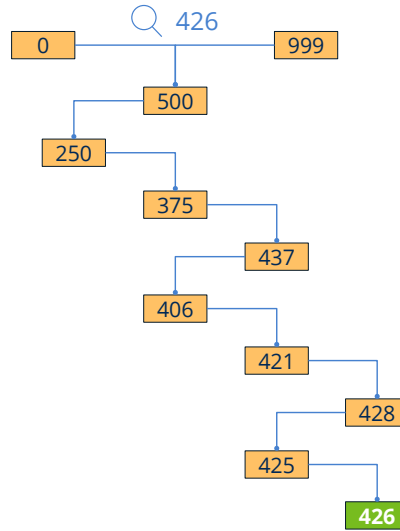

Figure 15.27: In a maximum of 10 steps we will find an element among a thousand (20 steps for a million).

- Use the function `arrst_sort`, to sort an array. We will have to pass a comparison function, which will determine the order relationship (Listing 15.29).

Listing 15.29: Sort arrays by product code.

```

static int i_compare(const Product *p1, const Product *p2)
{
    return str_scmp(p1->code, p2->code);
}

arrst_sort(arrst, i_compare, Product);
arrpt_sort(arrpt, i_compare, Product);

```

To search for an element within an array, we must also provide a function that compares the object with a key. This key contains the search criteria and is usually smaller than the element itself. Many times it is just a simple number or a text string (Listing 15.30).

- `arrst_search` Slow method. It will search for elements in a linear way, one by one $O(n)$.
- `arrst_bsearch` Fast method. It will search elements in logarithmic way, $O(\log n)$. The array must be sorted according to the same criteria as the search.

Listing 15.30: Search for an item by its code.

```

static int i_compare_key(const Product *p1, const char_t *key)
{
    return str_cmp(p1->code, key);
}

uint32_t pos;

```

```

Product *pr1, *pr2;
// Slow O(n)
pr1 = arrst_search(arrst, i_compare_key, "G3900", &pos, Product, char_t);

// Fast O(logn)
pr2 = arrst_bsearch(arrst, i_compare_key, "G3900", &pos, Product, char_t);

```

15.6.9. Arrays of basic types

The basic types are a particular case of single-field structure, so we will use it `ArrSt`. In the specific case of enum we must create an alias by `typedef`, as `ArrSt(type)` does not support the keyword `enum`, just as does not support `struct` keyword. In C++ this alias is not necessary. When destroying the array we will pass `NULL` to the destructor parameter, since the basic types do not generate dynamic memory.

```

typedef enum _type_t type_t;
ArrSt(uint32_t) *integers = arrst_create(uint32_t);
ArrSt(type_t) *types = arrst_create(type_t);
arrst_destroy(&integers, NULL, uint32_t);
arrst_destroy(&types, NULL, type_t);

```

15.7. Arrays (pointers)

15.8. Binary search trees

Like *arrays* **binary search trees (BST)**, also known as sets or maps, are containers that allow us to work with a collection of objects. The main difference with the first ones is that the elements are not stored linearly in contiguous positions of memory, but use a tree-shaped structure where each node has two descendants (Listing 15.31) (Figure 15.28).

Listing 15.31: Creation of arrays and sets.

```

typedef struct _product_t Product;
struct _product_t
{
    type_t type;
    String *code;
    String *description;
    Image *image64;
    real32_t price;
};

static int i_compare(const Product *p1, const Product *p2)
{
    return str_scmp(p1->code, p2->code);
}

```

```

ArrSt(Product) *arrst = arrst_create(Product);
ArrPt(Product) *arrpt = arrpt_create(Product);
SetSt(Product) *setst = setst_create(i_compare, Product);
SetPt(Product) *setpt = setpt_create(i_compare, Product);

```

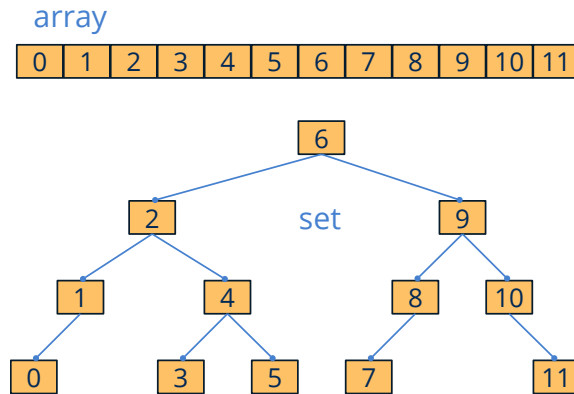

Figure 15.28: Array and set representation.

BSTs are structures optimized for cases where insertions, deletions and searches are very frequent. They are permanently sorted, hence it is possible to insert, delete or locate any element in logarithmic time $O(\log n)$, no need to use sort functions like `arrst_sort` (Figure 15.29). For maintenance to be carried out efficiently, the tree that supports the structure must meet a number of characteristics:

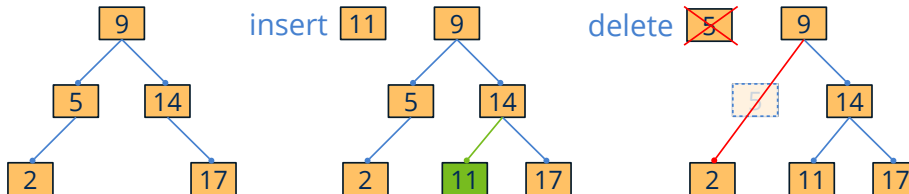

Figure 15.29: In search trees the insertion or deletion does not break the order of the set.

- **Binary** : Each node can only have 0, 1 or 2 children.
- **Sorted** : All descendants to the left of a node are of lesser value and those to the right of greater value. The order and search criteria are set in the constructor by a comparison function (`i_compare` in the previous example) and cannot be changed during the lifetime of the container. The new elements will be inserted in their correct position according to this order. It does not support duplicate elements or in arbitrary positions.
- **Balanced**: A tree can fulfill the two previous properties, but have degenerated to a list where searches can no longer be resolved in logarithmic time (Figure 15.30).

Internally, the NAppGUI `Set` containers are implemented with the so called *red-black trees*, where a maximum height of $2 \lceil \log(n+1) \rceil$ is guaranteed. This is achieved by restructuring the tree after each insertion or deletion, so adding a new element (or removing it) is resolved in a maximum of $O(\log n)$. This is much faster than in arrays, where have to move all the elements to insert a record in a specific position, with an associated cost of $O(n)$.

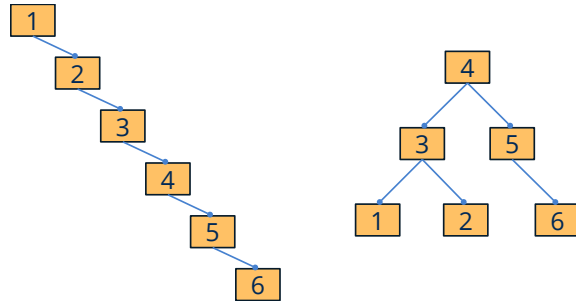

Figure 15.30: Degenerated and balanced search tree.

As we saw in “*Registers or pointers*” (page 216), we have two modalities when creating sets (Figure 15.31). The register-based version is more efficient than the pointer-based version, although less flexible.

- Use `setst_create` to create a set of registers.
- Use `setpt_create` to create a set of pointers.

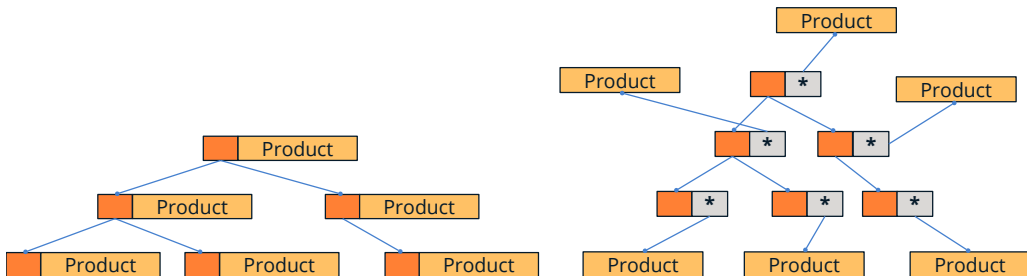

Figure 15.31: Sets of registers and pointers.

15.8.1. Iterators

We cannot access the elements of a set using a random index, as was the case with arrays. The nodes are dispersed in different memory areas, which prevents calculating the position of a particular element from a base address. An iterator is nothing more than a pointer within the set that acts as a marker for the currently selected element (Figure 15.32). From a specific position, we can move to the previous or subsequent element, but never make arbitrary jumps. We can control the position of the iterator with different functions (Listing 15.32):

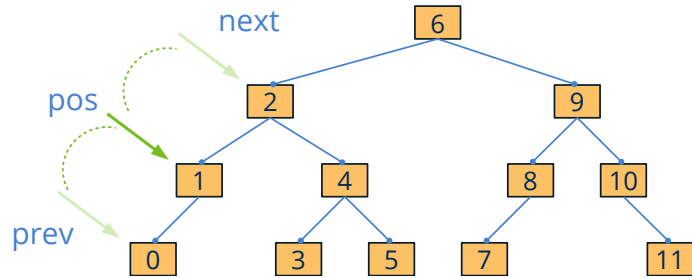

Figure 15.32: The iterators allow us to move through the structure.

- Use `setst_get` to search for an item. The iterator will be fixed on it.
- Use `setst_next` to move the iterator to the next item.
- Use `setst_prev` to move the iterator to the previous item.
- Use `setst_first` to move the iterator to the first element of the set.
- Use `setst_last` to move the iterator to the last element of the set.

Listing 15.32: Iterating over the elements of a *set*.

```

const Product *product = setst_first(setst, Product);
while (product != NULL)
{
    // Do something
    ...

    product = setst_next(setst, Product);
}

setst_foreach(product, setst, Product)
    // Do something
    ...
setst_fornext(product, setst, Product)

// In reverse order
setst_forback(product, setst, Product)
    // Do something
    ...
setst_forprev(product, setst, Product)

```

15.8.2. Arrays vs Sets comparative

We have performed a test to see the behavior of these two types of structures in real situations, apart from mere theory (Table 15.1). The structure used has been `Product` described in (Listing 15.31). We will compare six types of containers `ArrSt(Product)` and `ArrPt(Product)` (unsorted), `ArrSt(Product)` and `ArrPt(Product)` (sorted), `SetSt(Product)` and `SetPt(Product)`.

- The items will be sorted by `code` field using the method `i_compare` described in (Listing 15.31).
- The elements have been created previously and reside in memory. Times only reflect the management performed by the containers.
- Field `code` take values from "0" until "n-1", where `n=100,000` is the number of elements. The elements have been previously messed up using the function `bmem_shuffle_n`.
- The tests have been performed on a **Raspberry Pi 3 Model B** with NAppGUI compiled in Release version (*"Configurations"* (page 141)). We have chosen this platform because of its clear technical inferiority with respect to others. In this way the asymptotic difference is more evident.

Operation	ArrSt	ArrPt	ArrSt-Sort	ArrPt-Sort	SetSt	SetPt
Add(100k)	0.006	0.004	27.600	2.896	0.159	0.274
Loop(100k)	0.000	0.000	0.000	0.000	0.022	0.025
Search(100k)	84.139	588.080	0.101	0.218	0.121	0.232
Sort(100k)	0.085	0.205	-	-	-	-
Delete(100k)	0.004	0.003	31.198	3.064	0.171	0.253

Table 15.1: Results of the comparison (in seconds).

In view of these data, we can reach the following conclusions:

- Linear searches $O(n)$ are tremendously slow.
- Keeping an array sorted after each insertion or deletion is expensive. It is more efficient to add all the elements and then order, although this will not always be possible. If the elements enter or leave arbitrarily but the set must always be ordered, it is better to use Sets.
- Register-based containers are more efficient in queries, but less when inserting or deleting. However, this test does not include the time to create or release dynamic memory, something inherent in pointer containers.
- Iterating in arrays is almost free, but iterating in sets has a small cost due to the logic of jumping between nodes.
- We cannot say that one container is better than another in general. It will depend on each specific case.
- For small groups (less than 1000 elements) the differences are practically imperceptible.

- For extremely small groups (up to 100 items) always use arrays. The asymptotic Sets improvement is marred by the much more efficient implementation of the Arrays.

15.9. Binary search trees (pointers)

15.10. Regular expressions

Regular expressions define a text pattern that can be used to find or compare strings.

- Use `regex_create` to create a regular expression.
- Use `regex_match` to check if a string matches the pattern.

Listing 15.33: Using regular expressions.

```
Regex *regex = regex_create("*.txt");

const char_t *str[] = {
    "file01.txt",
    "image01.png",
    "sun01.jpg",
    "films.txt",
    "document.pdf"};

uint32_t i, n = sizeof(str) / sizeof(char_t*);

for (i = 0; i < n; ++i)
{
    if (regex_match(regex, str[i]) == TRUE)
        bstd_printf("YES: %s\n", str[i]);
    else
        bstd_printf("NO: %s\n", str[i]);
}

regex_destroy(&regex);
```

Result of (Listing 15.33).

```
YES: file01.txt
NO: image01.png
NO: sun01.jpg
YES: films.txt
NO: document.pdf
```

15.10.1. Define patterns

We can build a regular expression from a text string, following these simple rules:

- A string pattern corresponds only to that same string.

```
"hello" --> {"hello"}
```

- A period '.' is equivalent to “any character”.

```
"h.llo" --> {"hello", "htllo", "hälllo", "h5llo", ...}
```

- A dash 'A-Z' sets a range of characters, using the ASCII/Unicode code from both ends.

```
"A-Zello" --> {"Aello", "Bello", "Cello", ..., "Zello"}
```

```
'A-Z': (65-90) (ABCDEFGHIJKLMNOPQRSTUVWXYZ)
```

```
'0-9': (48-57) (0123456789)
```

```
'á-ú': (225-250) (áâãäåæçèéêëìíîïðñòóôõ÷øùú)
```

Like `String` objects, patterns are expressed in “UTF-8” (page 164), therefore the entire Unicode set can be used to create regular expressions.

- The brackets '[áéíóú]' allow you to switch between several characters.

```
"h[áéíóú]llo" --> {"hálllo", "hélllo", "hílllo", "hólllo", "húlllo"}
```

- The asterisk '*' allows the last character to appear zero or more times.

```
"he*llo" --> {"hllo", "hello", "heello", "heeello", "heeeello", ...}
```

```
"h.*llo" --> {"hllo", "hello", "hallo", "hillo", "hasello", ...}
```

```
"hA-Z*llo" --> {"hllo", "hAllo", "hABllo", "hVFFRREASllo" }
```

```
        --> {"hAQWEDllo", hAAABBERSllo", ...}
```

```
"FILE_0-9*.PNG" --> {"FILE_.PNG", "FILE_0.PNG", "FILE_01.PNG" }
```

```
        --> {"FILE_456.PNG", "FILE_112230.PNG", ...}
```

- The parentheses '(he*llo)' allow grouping a regular expression, so that it behaves as a single character.

```
"[(hello)(bye)]" --> {"hello", "bye" }
```

```
"[(red)(blue)(1*)]" --> {"red", "blue", "", "1", "11", "111", ... }
```

```
"(hello)*" --> {"", "hello", "hellohello", "hellohellohello", ... }
```

```
"(he*llo)ZZ" --> {"hlloZZ", "helloZZ", "heelloZZ", "heeeelloZZ", ... }
```

- For '.', '-', '[]', '*', '()' to be interpreted as characters, use the *backslash* '\\'.

```
"\\(he\\*\\-llo\\)" --> {"(he*-llo)"}
```

Remember that for expressions inserted as constants in C code, the backslash character is represented by a double slash "\\ (he\\ (\\ (-llo\\ ())".*

15.10.2. Regular languages and automata

Regular languages are those that are defined recursively using three basic operations on the set of characters (or symbols) available. They can be described using the regular expressions discussed above.

- Each character 'a' is a regular language 'A'.
- The union of two regular languages, is a regular language $A \cup B$.
- The concatenation of two regular languages, is a regular language $A \cdot B$.
- The closure of a regular language is a regular language A^* . This is where recursion comes in.

In this context the symbols are all Unicode characters. But you can define languages based on other alphabets, including the binary $\{0, 1\}$.

To recognize whether or not a string belongs to a certain regular language, it is necessary to build a **Finite Automata** based on the rules reflected in (Figure 15.33).

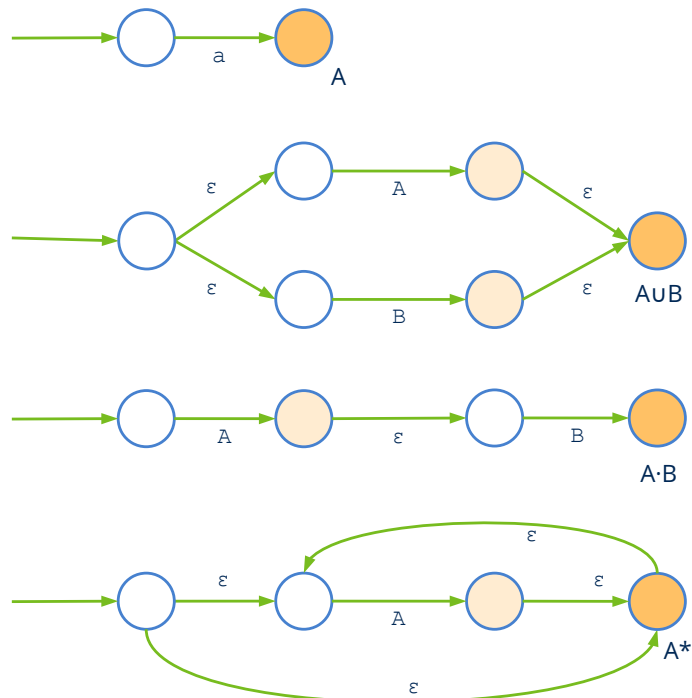

Figure 15.33: Construction of finite automata to filter regular expressions.

15.11. Data binding

We understand by *Data Binding* the possibility of automatically synchronizing the structures of the program with different input/output sources. We start from the simple model (Listing 15.34) that we present in “*Arrays*” (page 215) composed of a struct and an enum.

Listing 15.34: Simple data model based on struct.

```
typedef struct _product_t Product;

typedef enum _type_t
{
    ekCPU,
    ekGPU,
    ekHDD,
    ekSCD
} type_t;

struct _product_t
{
    type_t type;
    String *code;
    String *description;
    Image *image64;
    real32_t price;
};
```

The first thing we have to do is register this model in **dbind**, a kind of general “database” within our application (Listing 15.35). It is only necessary to carry out this process once when starting the program. In this way, internal tables will be created with the description of each structure of the data model (Figure 15.34), leaving the program ready to automate certain tasks when working with objects of said classes.

- Use `dbind` to register the fields of a structure.
- Use `dbind_enum` to register the different values of enum types.

Listing 15.35: Registering the data model of (Listing 15.34).

```
dbind_enum(type_t, ekCPU, "");
dbind_enum(type_t, ekGPU, "");
dbind_enum(type_t, ekHDD, "");
dbind_enum(type_t, ekSCD, "");
dbind(Product, type_t, type);
dbind(Product, String*, code);
dbind(Product, String*, description);
dbind(Product, Image*, image64);
dbind(Product, real32_t, price);
```

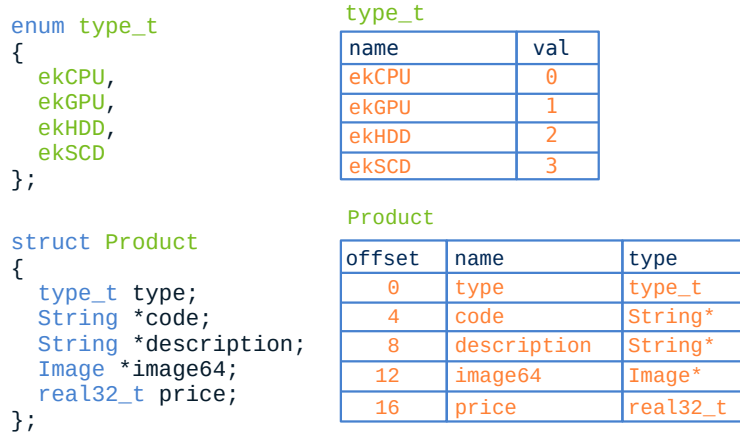

Figure 15.34: Internal tables created by *dbind* when registering the data model.

15.11.1. Synchronization with graphical interfaces

One of the most widespread uses of data binding is the possibility of synchronizing the graphical interface with the objects that make up the data model. This paradigm is known as MVVM (*Model-View-ViewModel*) (Figure 15.35) and we will delve deeper into it “*GUI Data binding*” (page 377).

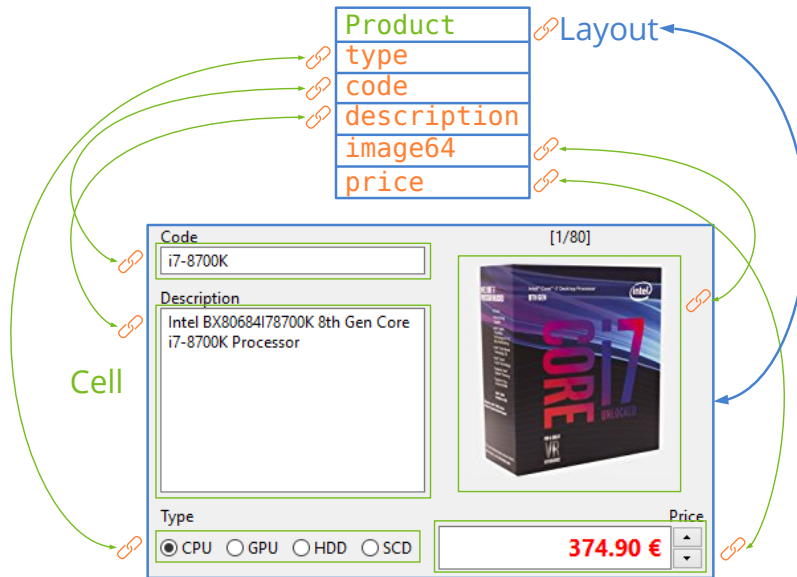

Figure 15.35: Automatic synchronization of data and interface.

15.11.2. Read and write JSON

The parsing of JSON scripts can also be automated thanks to *dbind* (Figure 15.36). In “JSON” (page 403) you will have detailed information on how to do it.

```
{
  "code":0,
  "size":80,
  "data":[
    {"id":0,
     "code":"i7-8700K",
     "description":"Intel BX80684I78700K 8th Gen Core i7-8700K Processor",
     "type":0,
     "price":374.8899999999999863575794734060764312744140625,
     "image":"cpu_00.jpg",
     "image64":"\79j\4AAQSkZJRgABAQ....
    },
    ...
  ]
}
```

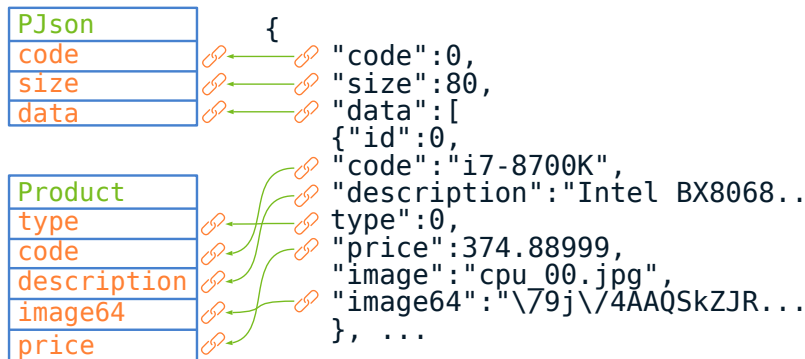

Figure 15.36: Data Binding in the analysis of JSON scripts.

15.11.3. Serialization with DBind

As we saw in “*Serialization*” (page 221) and “*Unify serialization*” (page 211) we need to define object reading and writing functions to send or receive them through streams. Fortunately, *dbind* knows the detailed composition of each registered object, so it’s possible access the I/O without having to explicitly program these functions (Listing 15.36) (Figure 15.37).

Listing 15.36: Objects serialization with *dbind*.

```
ArrPt(Product) *products = dbind_read(stream, ArrPt(Product));
...
dbind_write(stream, products, ArrPt(Product));
```

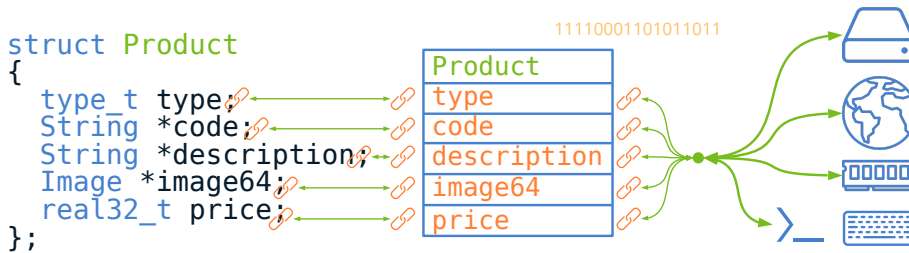

Figure 15.37: Object reading/writing via *dbind*.

15.11.4. Default constructor

Thanks to *dbind* we can also create objects initialized with default values without creating specific constructors (Listing 15.37). They can also be destroyed guaranteeing the correct recursive release of the memory of all their fields.

- Use `dbind_create` to create an object “Constructors” (page 219).
- Use `dbind_init` to initialize an object.
- Use `dbind_destroy` to destroy an object “Destructors” (page 222).

Listing 15.37: Construction and destruction without additional methods.

```

ArrSt(Product) *array = dbind_create(ArrSt(Product));
Product *pr1 = dbind_create(Product);
Product *pr2 = arrst_new(array, Product);
dbind_init(pr2, Product);

// Use objects
...

dbind_destroy(&pr1, Product);
dbind_destroy(&array, ArrSt(Product));

```

The default values when initializing object fields are 0 for numbers, `FALSE` for booleans, `""` for Strings and empty containers in the case of arrays or sets. If the object contains nested sub-objects, they will also be created/initialized recursively. These default values can be changed if necessary (Listing 15.38).

- Use `dbind_default` to set the default value.

Listing 15.38: Changing the default values.

```

dbind_default(Product, type_t, type, ekHDD);
dbind_default(Product, String*, code, "Empty-code");
dbind_default(Product, real32_t, price, 5.f);
dbind_default(Product, Image*, image64, gui_image(NOIMAGE_PNG));

```

15.11.5. Numerical ranges

It is possible to configure the numeric fields `uint32_t`, `int8_t`, `real64_t`, etc to limit the accepted values (Listing 15.39). `dbind` will be responsible for validating the data every time it reads values from any data source (GUI, JSON, Streams, etc).

- Use `dbind_range` to set a maximum and minimum numerical values.
- Use `dbind_precision` to set numerical precision. For example 0.01 in monetary values.
- Use `dbind_increment` to set the value of discrete increments.
- Use `dbind_suffix` to set a suffix that will be added when converting numbers to text.

Listing 15.39: Value range and accuracy of price value.

```
dbind_default(Product, real32_t, price, 10f);
dbind_range(Product, real32_t, price, .50f, 10000f);
dbind_precision(Product, real32_t, price, .01f);
dbind_increment(Product, real32_t, price, 5.f);
dbind_suffix(Product, real32_t, price, "€");
```

15.12. Events

An event is an action that occurs during the program execution, usually asynchronously or unpredictably and on which a given object must be notified. In applications with a graphical interface, many events are constantly occurring when the user interacts with the different controls. However, they can also occur in console applications, for example, when finish the writing of a file to disk or when downloading a page from Internet. In a system of events two actors intervene: The sender, which has evidence when the action occurs and the receiver who is notified that such action has occurred. To connect both ends we must perform these simple steps (Listing 15.40) (Figure 15.38):

- Create a `listener` indicating the receiving object and the *callback* function to which the sender should call.
- Said *listener* is assigned to the sender by the appropriate method. For example, the `Button` type provide the method `button_OnClick` to notify of a click.
- When the event occurs, the sender calls the *callback* function, indicating the receiving object (parameter of `listener`) and detailed information about the event collected in the object `Event`.

Listing 15.40: *Callback* function and button click event.

```
static void OnClick(AppCtrl *ctrl, Event *event)
```

```

{
    // TODO: Response to click
}

...

void CreateButton(AppCtrl *ctrl)
{
    Button *button = button_push();
    button_text(button, "Ok");
    button_OnClick(button, listener(ctrl, OnClick, AppCtrl));
}

```

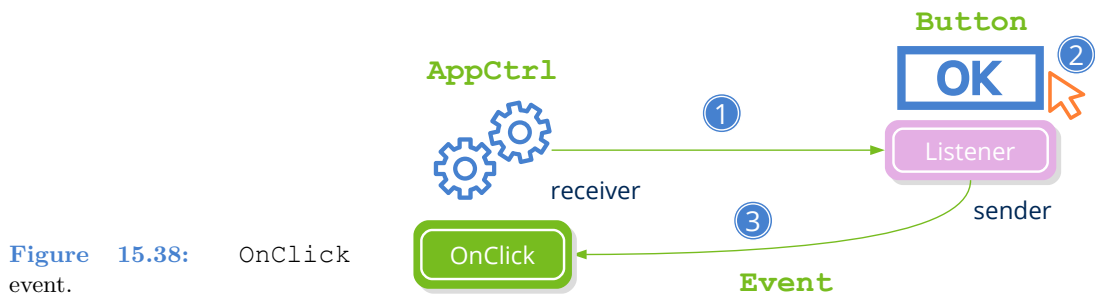

Figure 15.38: OnClick event.

Events are used in bulk in GUI applications, but can also be useful in command line applications. See for example `hfile_dir_loop` in “File operations” (page 238).

15.13. Keyboard buffer

The operating system generates events related to the pressing or releasing keys `view_OnDown` `view_OnUp`. Sometimes we need to know the state of a key without having to be aware of the events they generate. `KeyBuf` offers a very simple query mechanism using only the value of the `vkey_t` key.

- Use `keybuf_create` to create the buffer.
- Use `view_keybuf` to assign the buffer to any generic view, which will be in charge of capturing events and updating it. The status may be consulted from any program function at any time.

15.14. File operations

Although in “Files and directories” (page 185) we already saw how to access the file system at a low level, sometimes certain high-level operations are necessary on the data on disk. The mere act of completely deleting a directory has many individual low-level

operations associated with it. The *Core* library, through `<hfile.h>` provides certain utilities that can simplify our lives at certain times.

- Use `hfile_dir_create` to create a directory, also creating its predecessors if they don't exist.
- Use `hfile_dir_destroy` to recursively delete a directory and all its contents.
- Use `hfile_dir_sync` to synchronize the contents of two directories. Something similar to Unix `rsync`.
- Use `hfile_dir_loop` to go deep through a directory (Listing 15.41).
- Use `hfile_buffer` to load the contents of a file into memory.

Listing 15.41: Using `hfile_dir_loop` to loop through a three-level directory.

```
typedef struct _query_t Query;

static void i_OnEntry(Query *query, Event *e)
{
    const EvFileDir *p = event_params(e, EvFileDir);

    // First level (year)
    if (p->depth == 0)
    {
        // The entry is a directory
        if (event_type(e) == ekENTRY)
        {
            bool_t *enter = event_result(e, bool_t);
            int16_t year = str_to_i16(p->filename, 10, NULL);

            // The loop enter in this subdir (depth 1)
            if (i_process_year(query, year) == TRUE)
                *enter = TRUE;
            else
                *enter = FALSE;
        }
    }
    // Second level (month)
    else if (p->depth == 1)
    {
        // The entry is a directory
        if (event_type(e) == ekENTRY)
        {
            bool_t *enter = event_result(e, bool_t);
            uint8_t month = str_to_u8(p->filename, 10, NULL);

            // The loop enter in this subdir (depth 2)
            if (i_process_month(query, month) == TRUE)
                *enter = TRUE;
            else
                *enter = FALSE;
        }
    }
}
```



```

        *enter = FALSE;
    }
}
// Third level (files)
else if (p->depth == 2)
{
    // The entry is a file
    if (event_type(e) == ekEFILE)
        i_process_file(query, p->pathname);
}
}
/*-----*/

Query query = i_init_query(&query);

hfile_dir_loop("main_path", listener(&query, i_OnEntry, Query), TRUE, FALSE,
    ↪ NULL);

```

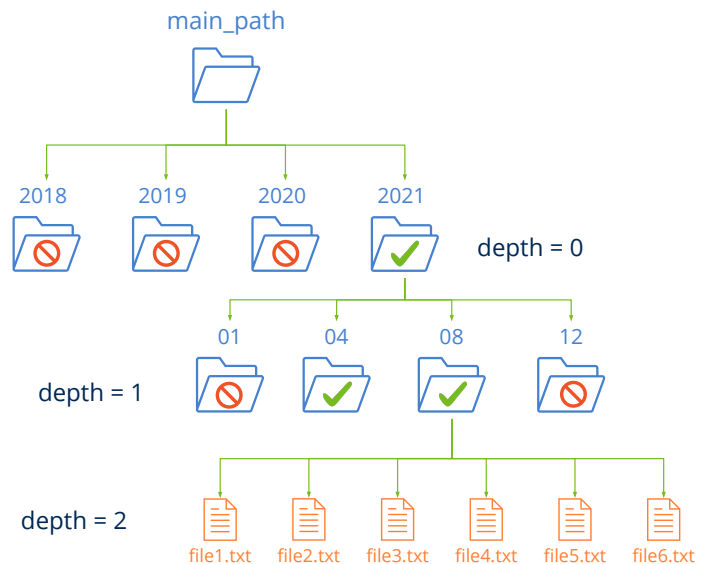

Figure 15.39: Representation of directory of (Listing 15.41).

15.15. Resource packs

15.16. Dates

A series of functions are included within *core* to work with dates.

- Use `date_system` to get the system date.
- Use `date_add_seconds` to increment a given date.

- Use `date_cmp` to compare two dates.

15.17. Clocks

Simple objects that allow us, in a comfortable way, to measure the time span between two instants. They are also useful for launching events at regular time intervals (Listing 15.42).

Listing 15.42: 25fps animation.

```
Clock *clock = clock_create(.04);
for (;;)
{
    ...
    if (clock_frame(clock) == TRUE)
        listener_event(transition, ekGUI_EVENT_ANIMATION, NULL, params, NULL,
            ↪ void, EvTransition, void);
    ...
}
clock_destroy(&clock);
```

Geom2D library

16.1 Geom2D	243
16.2 2D Vectors	245
16.2.1 CW and CCW angles	246
16.2.2 Vector projection	246
16.3 2D Size	248
16.4 2D Rectangles	248
16.5 2D Transformations	249
16.5.1 Elementary transformations	249
16.5.2 Composition of transformations	250
16.5.3 Decomposition and inverse	253
16.6 2D Segments	254
16.7 2D Circles	255
16.8 2D Boxes	255
16.9 2D Oriented Boxes	255
16.10 2D Triangles	257
16.11 2D Polygons	258
16.11.1 Polygon center	259
16.11.2 Polygon decomposition	260
16.12 2D Collisions	261

16.1. Geom2D

We are facing a geometric calculation library in two dimensions. Geom2D allows working with primitives in the real plane: Points, vectors, transformations, curves and surfaces.

It offers only mathematical functionality, that is, it does not define any type of representation or drawing operation. It only depends on “*Core*” (page 195) library (Figure 16.1), so it can be used in both desktop applications and command line utilities. All types and functions are defined in simple (`float`) and `double` precision, in addition to being able to make use of C++ “*Math templates*” (page 53).

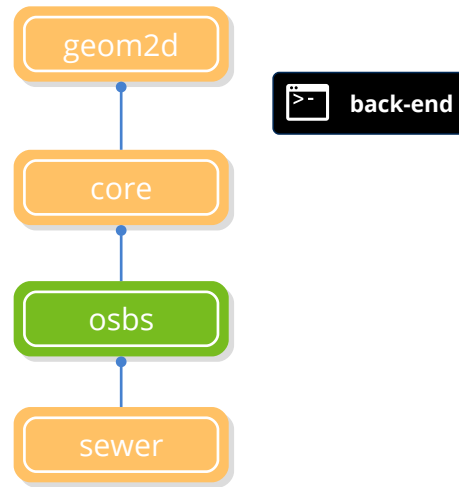

Figure 16.1: Dependencies of *geom2d*. See “*NAppGUI API*” (page 151).

All geometric elements are based on (x, y) coordinates in the plane. *Geom2D* does not assume how these coordinates will be interpreted. That will depend on the reference system defined by the application. The most used are the Cartesian and the screen (Figure 16.2), although others systems could be used where appropriate (Figure 16.3).

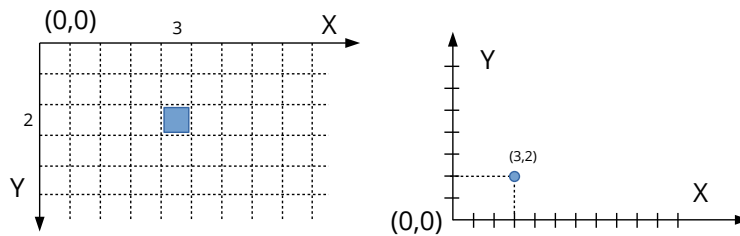

Figure 16.2: Interpretation of the coordinate $(3,2)$ on monitors (left) and on the Cartesian plane (right).

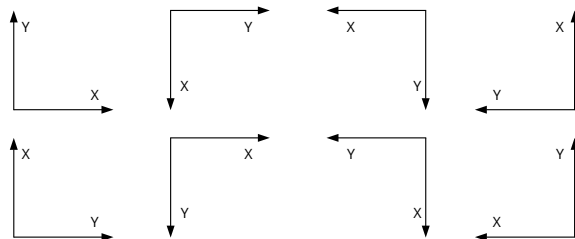

Figure 16.3: Different 2D coordinate systems.

16.2. 2D Vectors

Vector (`v2Df`, `v2Dd`) is the most elementary geometric element. It represents a point, a direction or displacement by its two components \mathbf{x} and \mathbf{y} (Figure 16.4).

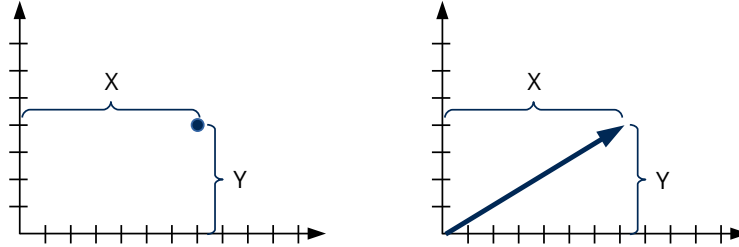

Figure 16.4: A 2D vector represents a position or a displacement in the plane.

The Vectorial Algebra defines a series of basic operations: Addition, negation, multiplication by a scalar, module and normalization (Formula 16.1). The visual representation of these operations is in (Figure 16.5).

$$\begin{aligned}
 \vec{v} &= \vec{a} + \vec{b} \\
 &= (a.x + b.x, a.y + b.y) \\
 \vec{v} &= p2 - p1 \\
 &= (p2.x - p1.x, p2.y - p1.y) \\
 -\vec{a} &= (-a.x, -a.y) \\
 \vec{v} &= s \cdot \vec{a} \\
 &= (s \cdot a.x, s \cdot a.y) \\
 |\vec{a}| &= \sqrt{a.x^2 + a.y^2} \\
 \hat{a} &= \left(\frac{a.x}{|\vec{a}|}, \frac{a.y}{|\vec{a}|} \right)
 \end{aligned}$$

Formula 16.1: Elementary vector algebra.

- Use `v2d_addf` to add two vectors.
- Use `v2d_subf` to subtract two vectors.
- Use `v2d_mulf` to multiply by a scalar.
- Use `v2d_lengthf` to calculate the modulus of a vector.
- Use `v2d_normf` to normalize a vector.

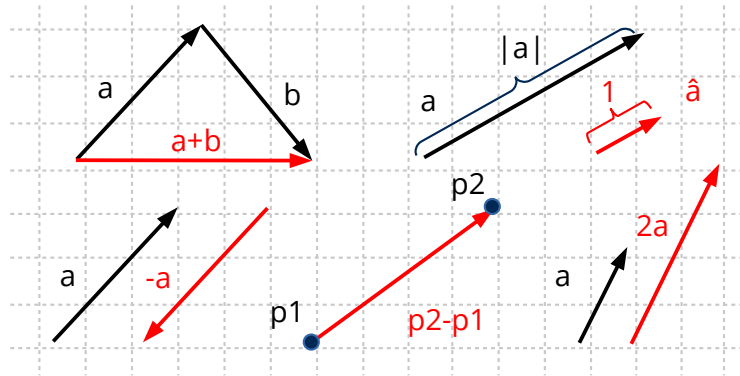

Figure 16.5: Geometric interpretation of basic operations with vectors.

16.2.1. CW and CCW angles

The angle of rotation of a vector will always be expressed in **radians** and the **positive direction** corresponds to the rotation from the **X axis to the Y axis**. Normally the counterclockwise direction is associated as positive and the clockwise direction negative. This is true in Cartesian coordinates but not in other types of reference systems, such as images or monitors (Figure 16.6). We must bear this in mind to avoid confusion, something that happens relatively frequently. The same criterion is applied when calculating the perpendicular vector, differentiating between positive and negative.

- Use `v2d_anglef` to get the angle between two vectors.
- Use `v2d_rotatef` to apply a rotation to a vector.
- Use `v2d_perp_posf` to calculate the positive perpendicular vector.

*To avoid confusion, remember that the positive direction is the one that rotates from the X axis to the Y axis. It will be **counterclockwise direction** in Cartesian coordinates and **clockwise direction** in screen coordinates.*

16.2.2. Vector projection

Another operation used quite frequently in geometry is the projection of points onto a vector. Intuitively, we can see it as the point on the vector closest to the original point and that it will always be on the perpendicular line. We will calculate it with the dot product (Formula 16.2) and its value (scalar) will be the distance from the origin to the projection in the direction of the vector (Figure 16.7).

- Use `v2d_dotf` to calculate the dot product of two vectors.

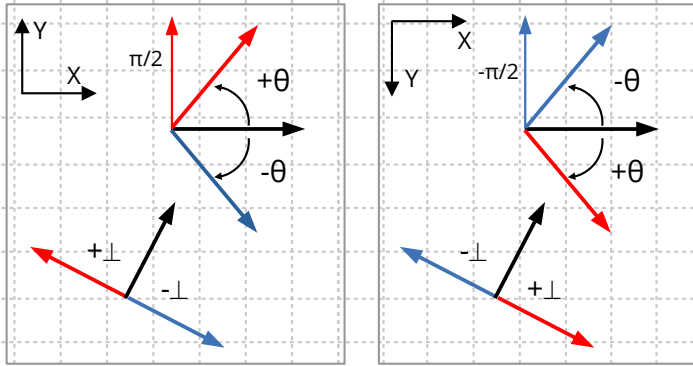

Figure 16.6: Rotation of a vector in Cartesian and screen systems.

$$\begin{aligned} \text{proj}_{\vec{v}}(p) &= \frac{v.x \cdot p.x + v.y \cdot p.y}{|\vec{v}|} \\ \text{proj}_{4,3}(1, 2) &= \frac{4 \cdot 1 + 3 \cdot 2}{5} = 2 \\ \text{proj}_{4,3}(2, -2) &= 0.4 \\ \text{proj}_{4,3}(5, 1) &= 4.6 \\ \text{proj}_{4,3}(-3, 1) &= -1.8 \end{aligned}$$

Formula 16.2: Projection of several points in a vector.

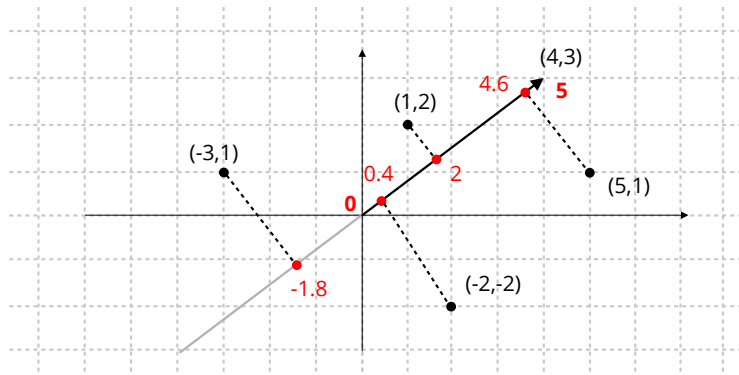

Figure 16.7: Geometric interpretation of projections.

If we are interested in the relative position between different projections, we can avoid dividing by the vector's modulus, which is more computationally efficient by not calculating square roots.

16.3. 2D Size

The `S2Df`, `S2Dd` structure stores information about a measure or size in two dimensions using its fields `width` and `height`.

- Use `s2df` to compose a measure through its elementary fields.

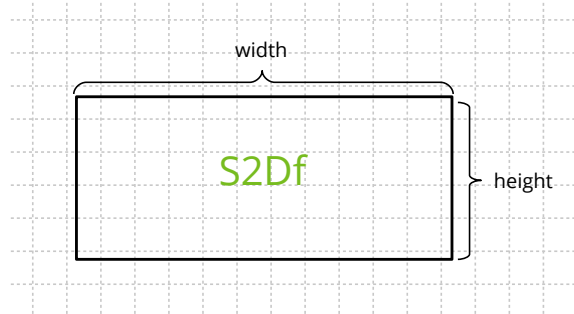

Figure 16.8: Size2D.

16.4. 2D Rectangles

A rectangle (or *frame*) (`R2Df`, `R2Dd`) (Figure 16.9) is used to locate elements in user interfaces or other 2D systems through a point of origin `V2Df` and a size `S2Df`. They can also be used in clipping operations, when optimizing drawing tasks.

- Use `r2d_collidef` to determine if two rectangles collide.
- Use `r2d_clipf` to determine if a rectangle is visible within an area.
- Use `r2d_joinf` to join the two rectangles.

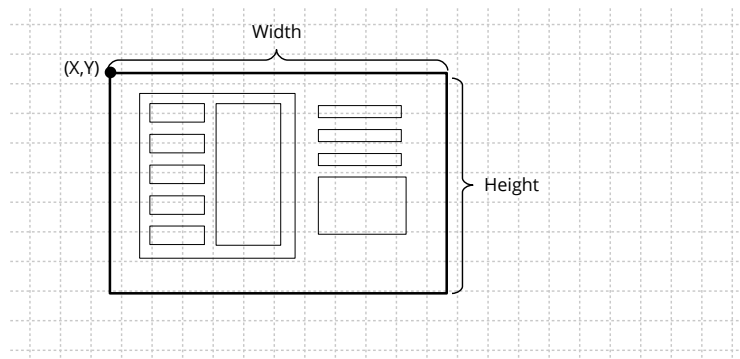

Figure 16.9: Positioning GUI elements using rectangles.

16.5. 2D Transformations

Affine transformations are a type of mathematical operation that allows coordinate changes between different reference systems. For example in (Figure 16.10) **(a)** we construct a polygon expressing the coordinates of its vertices in a Cartesian system: $[(4,1), (2,5), (-3,5), (-4,2), (0, -3)]$. Now let's imagine that we want to draw several instances of our model on a plane, each with a different position, orientation and size (Figure 16.10) **(b)**. We would need to calculate the coordinates of the points of the polygon in the new locations, in order to correctly draw the lines that delimit them.

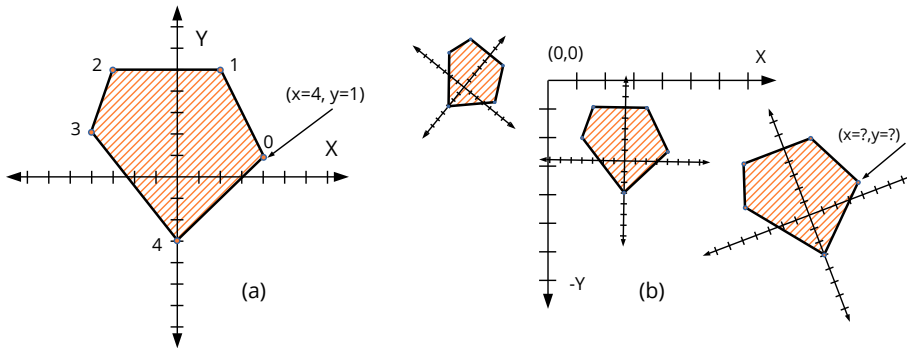

Figure 16.10: Geometric model (a) Expressed in a Cartesian system. (b) After applying transformations.

Vector Algebra gives us a powerful tool with which the relationship between two systems can be expressed using six real numbers (Figure 16.11). The first four values correspond to a 2×2 matrix with the coordinates of the vectors $X=[1,0]$ and $Y=[0,1]$ in the new reference system. This matrix integrates a possible rotation and scaling of the axes. The last two values indicate a displacement in the origin of coordinates. In (Formula 16.3) we have the mathematical development to transform the point $[4.1]$ to a new base rotated 25° with respect to the origin and displaced 11 units on the X axis and -5 on the Y axis. Applying the same operation to all points, we would transform the object.

16.5.1. Elementary transformations

In principle, any combination of values $[i.x, i.y, j.x, j.y, p.x, p.y]$ would provide a valid transformation, although if we do not choose them with certain criteria we will obtain aberrations that are not very useful in practice. The most used transformations in graphic and engineering applications are (Figure 16.12) (Figure 16.13) (Formula 16.4):

- Translation **(a)**: Moves the origin of the object to another point.
- Rotation **(b)**: Rotates the object on the origin of its local system.
- Scaling **(c)**: Change the size. If $sx < 1$, reduce. $sx > 1$, increase. $sx = 1$, does not

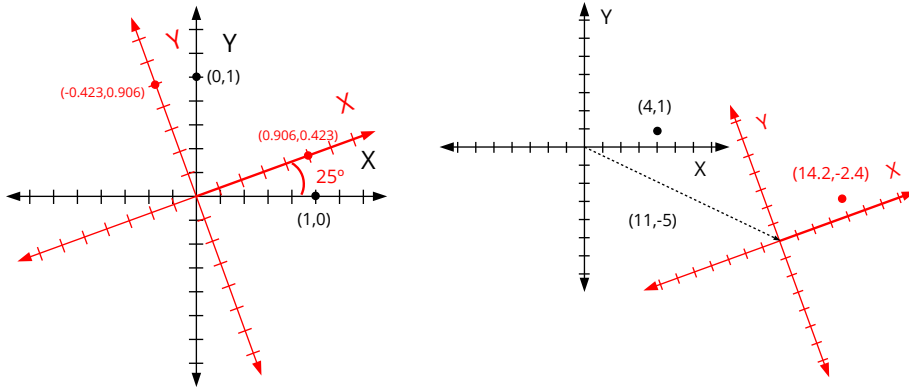

Figure 16.11: Change of base. Relationship of a point in two different reference systems.

$$\begin{aligned}
 \begin{bmatrix} x' \\ y' \end{bmatrix} &= \begin{bmatrix} i.x & j.x \\ i.y & j.y \end{bmatrix} \begin{bmatrix} x \\ y \end{bmatrix} + \begin{bmatrix} p.x \\ p.y \end{bmatrix} \\
 &= \begin{bmatrix} 0.906 & -0.423 \\ 0.423 & 0.906 \end{bmatrix} \begin{bmatrix} 4 \\ 1 \end{bmatrix} + \begin{bmatrix} 11 \\ -5 \end{bmatrix} \\
 &= \begin{bmatrix} 3.2 \\ 2.6 \end{bmatrix} + \begin{bmatrix} 11 \\ -5 \end{bmatrix} \\
 &= \begin{bmatrix} 14.2 \\ -2.4 \end{bmatrix}
 \end{aligned}$$

Formula 16.3: Point [4,1] transformation.

vary. In non-uniform scales, s_x and s_y have different values, which will produce a distortion in the aspect ratio.

- Identity (**d**): It is the null transformation. When applied, the vectors remain unchanged.

16.5.2. Composition of transformations

It is possible to compose or accumulate transformations by matrix multiplication (Formula 16.5). The usual thing in 2d models will be to obtain the final location of an object from the elementary transformations translation, rotation and scaling. The accumulation is also useful for positioning elements in hierarchical structures, where the location of each object depends directly on that of its upper node (parent).

- Use `t2d_movef` to add a displacement to an existing transformation.

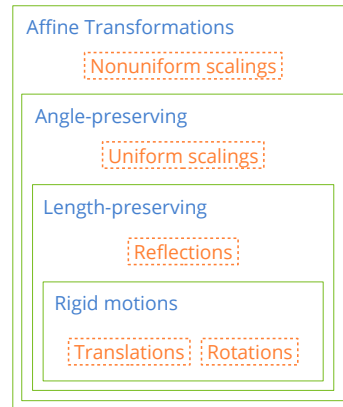

Figure 16.12: Classification of affine transformations.

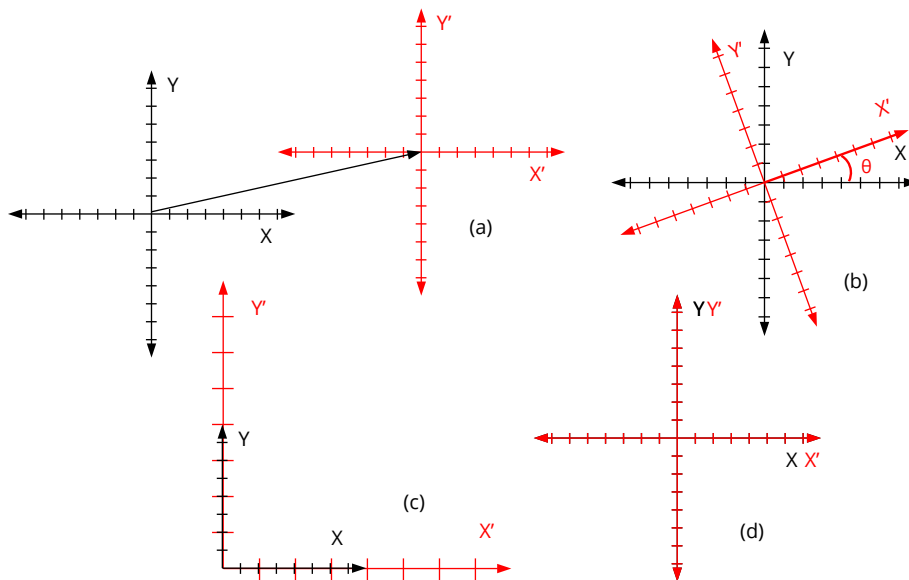

Figure 16.13: Geometric representation of elementary transformations. (a) Translation, (b) Rotation, (c) Scaling, (d) Identity.

- Use `t2d_rotatef` to add a rotation.
- Use `t2d_scalef` to add a scaling.
- Use `t2d_multf` to add a transformation.
- Use `t2d_vmultf` to apply a transformation to a vector.
- Use `t2d_vmultnf` to apply a transformation to several vectors.
- Use `KT2D_IDENTf` to reference the identity transformation.

Matrix multiplication is not commutative, but the order in which the operations are

$$\begin{aligned} \begin{bmatrix} x' \\ y' \end{bmatrix} &= \begin{bmatrix} 1 & 0 \\ 0 & 1 \end{bmatrix} \begin{bmatrix} x \\ y \end{bmatrix} + \begin{bmatrix} p.x \\ p.y \end{bmatrix} \\ \begin{bmatrix} x' \\ y' \end{bmatrix} &= \begin{bmatrix} \cos\theta & -\sin\theta \\ \sin\theta & \cos\theta \end{bmatrix} \begin{bmatrix} x \\ y \end{bmatrix} + \begin{bmatrix} 0 \\ 0 \end{bmatrix} \\ \begin{bmatrix} x' \\ y' \end{bmatrix} &= \begin{bmatrix} sx & 0 \\ 0 & sy \end{bmatrix} \begin{bmatrix} x \\ y \end{bmatrix} + \begin{bmatrix} 0 \\ 0 \end{bmatrix} \\ \begin{bmatrix} x' \\ y' \end{bmatrix} &= \begin{bmatrix} 1 & 0 \\ 0 & 1 \end{bmatrix} \begin{bmatrix} x \\ y \end{bmatrix} + \begin{bmatrix} 0 \\ 0 \end{bmatrix} \end{aligned}$$

Formula 16.4: Translation, Rotation, Scaling and Identity.

$$\begin{aligned} \begin{bmatrix} x' \\ y' \end{bmatrix} &= \begin{bmatrix} i_d.x & j_d.x \\ i_d.y & j_d.y \end{bmatrix} \begin{bmatrix} x \\ y \end{bmatrix} + \begin{bmatrix} p_d.x \\ p_d.y \end{bmatrix} \\ i_d.x &= i_1.x \cdot i_2.x + j_1.x \cdot i_2.y \\ i_d.y &= i_1.y \cdot i_2.x + j_1.y \cdot i_2.y \\ j_d.x &= i_1.x \cdot j_2.x + j_1.x \cdot j_2.y \\ j_d.y &= i_1.y \cdot j_2.x + j_1.y \cdot j_2.y \\ p_d.x &= i_1.x \cdot p_2.x + j_1.x \cdot p_2.y + p_1.x \\ p_d.y &= i_1.y \cdot p_2.x + j_1.y \cdot p_2.y + p_1.y \end{aligned}$$

Formula 16.5: Composition of two arbitrary transformations.

applied will affect the final result. For example in (Figure 16.14) **(a)**, the origin has been moved and then applied a rotation. In (Figure 16.14) **(b)** it has been done on the contrary, first rotate and then move.

Listing 16.1: Acumulación de transformaciones.

```
// (a) First move, then rotate
T2Df t2d;
t2d_movef(&t2d, kT2D_IDENTf, 11, 0);
t2d_rotatef(&t2d, &t2d, kBMath_Pi / 4);

// (b) First rotate, then move
T2Df t2d;
t2d_rotatef(&t2d, kT2D_IDENTf, kBMath_Pi / 4);
t2d_movef(&t2d, &t2d, 11, 0);
```

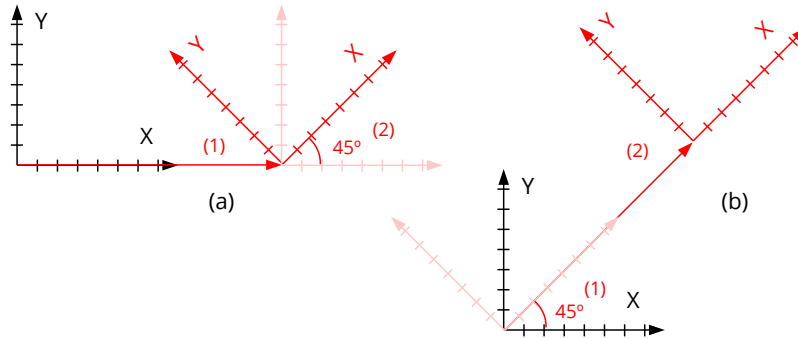

Figure 16.14: Effect of the order of application of transformations.

16.5.3. Decomposition and inverse

Any chain of translations, rotations, and scales defines an affine reference frame that can be expressed in terms of a single translation, rotation, and scale (Figure 16.15). We can “undo” this transformation and return to the origin through the inverse transformation (Listing 16.2).

- Use `t2d_decomposef` to get the components of a transformation.
- Use `t2d_inversef` to get the inverse transformation.

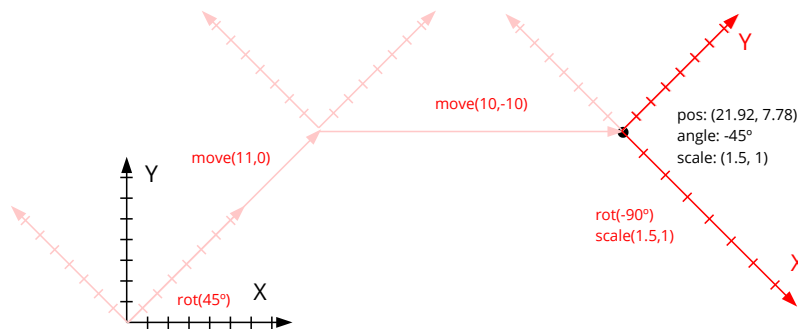

Figure 16.15: Transformation chain and final system.

Listing 16.2: Components of a reference and inverse system.

```
T2Df t2d, inv, inv2;
V2Df pos, sc;
real32_t a;

// Transform sequence
t2d_rotatef(&t2d, kT2D_IDENTf, kBMath_Pi / 4);
t2d_movef(&t2d, &t2d, 11, 0);
t2d_movef(&t2d, &t2d, 10, -10);
t2d_rotatef(&t2d, &t2d, - kBMath_Pi / 2);
```

```

t2d_scalef(&t2d, &t2d, 1.5f, 1);

// Transform components
t2d_decomposef(&t2d, &pos, &a, &sc);

// Transform inverse
t2d_inversef(&inv, &t2d);

// Inverse from components
t2d_scalef(&inv2, kT2D_IDENTf, 1/sc.x, 1/sc.y);
t2d_rotatef(&inv2, &inv2, -a);
t2d_movef(&inv2, &inv2, -pos.x, -pos.y);

// inv == inv2 ('inv' more numerical accurate)

```

16.6. 2D Segments

Segments are fragments of a line between two points **p0** and **p1** (Figure 16.16). They are the simplest geometric primitives, after vectors. We define the **t** parameter as the normalized position within the segment. Values between 0 and 1 will correspond to internal points of the segment, with the limits $t=0$ (**p0**) and $t=1$ (**p1**). Out of this range we will have the points outside the segment, but within the line that contains it. For example $t=2$ would be the point after **p1** located at a distance equal to the length of the segment.

- Use `seg2d_lengthf` to get the length of the segment.
- Use `seg2d_close_paramf` to get the value of the parameter closest to a certain point.
- Use `seg2d_evalf` to get the point from the parameter.
- Use `seg2d_sqdistf` to get the distance (squared) between two segments.

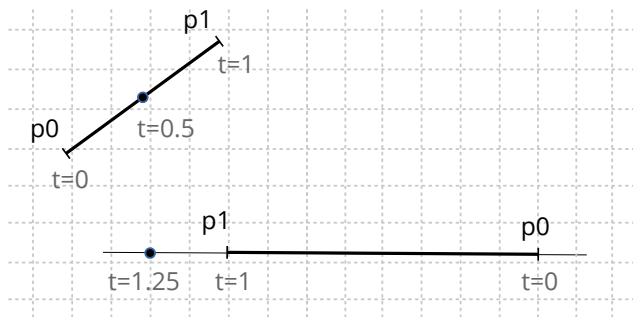

Figure 16.16: Segments in the plane.

16.7. 2D Circles

Circles allow us to group a set of points within the same container volume. Collision detection will be performed optimally since it is the geometric test that requires the fewest operations. Given a set of points, we can calculate the container circle in various ways (Figure 16.17) depending on the precision and speed needed.

- Use `cir2d_from_boxf` to get the circle from a 2D box.
- Use `cir2d_minimumf` to obtain the circle of minimum radius from a set of points.
- Use `cir2d_from_pointsf` to obtain the circle from the the set average. More balanced option in terms of precision/performance.

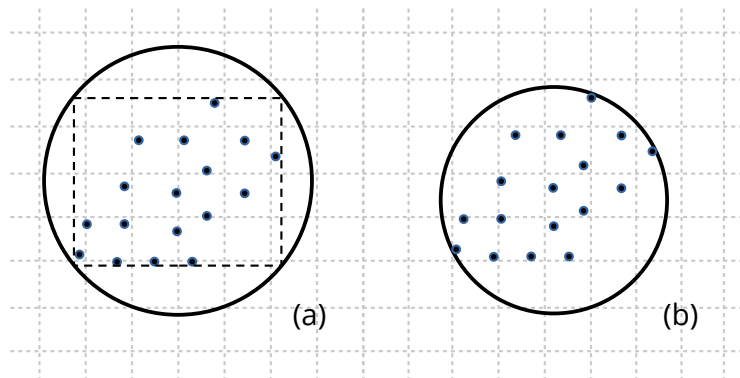

Figure 16.17: Container circle: From BBox (a). Minimum radius (b).

16.8. 2D Boxes

2D containers or (*Bounding boxes*) delimit the area of the plane occupied by different geometric elements (Figure 16.18). They are useful in the collision detection or *clipping operations*, which prevent non-visible figures from being drawn, improving overall performance.

- Use `box2d_from_pointsf` to create a 2D box from a set of points.
- Use `box2d_addnf` to change dimensions based on new points.
- Use `box2d_segmentsf` to get the four segments that delimit the box.

16.9. 2D Oriented Boxes

Oriented Bounding Boxes are 2D boxes that can rotate about their center (Figure 16.19), so they will no longer be aligned with axes. Here the collision detection is somewhat

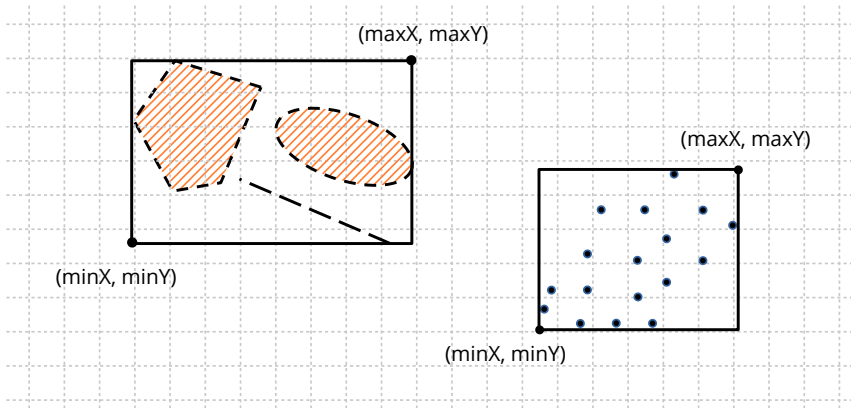

Figure 16.18: 2D boxes as a container for other objects.

complicated compared to 2D Axis-Aligned boxes, in exchange for providing a better fit against elongated objects that can rotate in the plane.

- Use `obb2d_from_pointsf` to create an oriented box from a set of points.
- Use `obb2d_from_linef` to create an oriented box from a segment.
- Use `obb2d_transformf` to apply a 2D transformation to the box.
- Use `obb2d_boxf` to get the aligned box containing the oriented box.

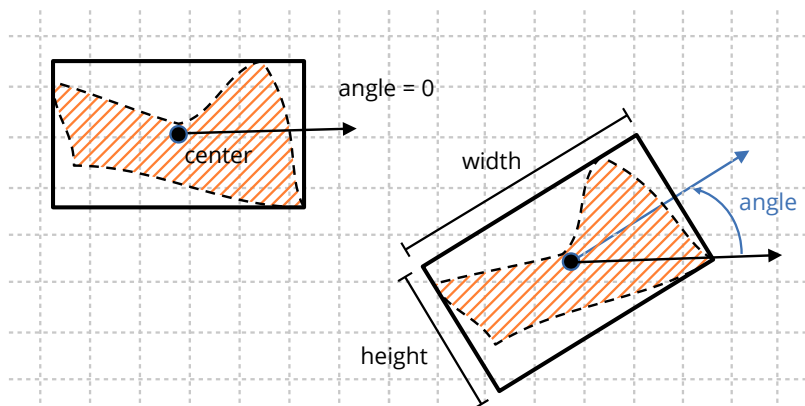

Figure 16.19: 2D oriented boxes.

We can obtain relevant parameters of an arbitrary set of points from the covariance matrix (Formula 16.6), which is geometrically represented by an ellipse rotated in the plane and centered on the mean of the distribution (Figure 16.20). This analysis allows `obb2d_from_pointsf` to calculate the 2D box associated with the distribution in a quite acceptable way, without becoming the optimal solution that is much more expensive in

computational terms.

$$\begin{aligned}\Sigma &= \begin{bmatrix} \sigma_{xx} & \sigma_{xy} \\ \sigma_{yx} & \sigma_{yy} \end{bmatrix} \\ \sigma_{xx} &= \frac{1}{N} \left[\sum_{i=1}^N x_i^2 \right] - \mu_x^2 \\ \sigma_{yy} &= \frac{1}{N} \left[\sum_{i=1}^N y_i^2 \right] - \mu_y^2 \\ \sigma_{xy} &= \frac{1}{N} \left[\sum_{i=1}^N x_i y_i \right] - \mu_x \mu_y \\ \sigma_{yx} &= \sigma_{xy} \\ \mu_x &= \frac{1}{N} \sum_{i=1}^N x_i \\ \mu_y &= \frac{1}{N} \sum_{i=1}^N y_i\end{aligned}$$

Formula 16.6: Calculation of the covariance matrix.

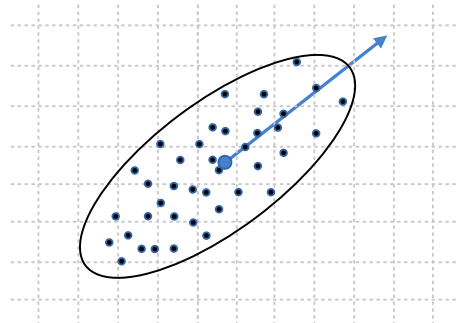

Figure 16.20: The covariance matrix represents an ellipse rotated in the plane.

Use oriented boxes (`OBB2Df`) for “elongated” point distributions. In rounded or square cases the aligned box (`Box2Df`) can provide a volume with a smaller area.

16.10. 2D Triangles

Triangles are widely used in computational geometry, especially when performing certain calculations on polygons or surfaces. They are also the basis of most graphical APIs, so on many occasions we will need to approximate objects using triangles. The **centroid**

is the equilibrium point found at the intersection of the medians (Figure 16.21).

- Use `tri2df` to compose a triangle.
- Use `tri2d_transformf` to apply a transformation.
- Use `tri2d_centroidf` to get the center of mass.
- Use `tri2d_areaf` to calculate the area.

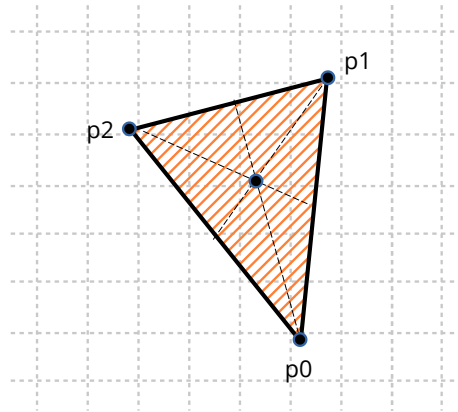

Figure 16.21: 2D triangles.

16.11. 2D Polygons

Polygons are widely versatile figures, since they allow us to define arbitrary regions delimited by rectilinear segments. Geom2D supports so-called **simple polygons**, which are those whose sides cannot intersect each other.

- Use `pol2d_createf` to create a polygon from the path formed by its vertices.
- Use `pol2d_ccwf` to get the direction of path rotation. See “*CW and CCW angles*” (page 246).
- Use `pol2d_transformf` to apply a transformation to the polygon.
- Use `pol2d_areaf` to get the area.
- Use `pol2d_boxf` to get the polygon boundaries.

We can classify the polygons into three large groups (Figure 16.22):

- **Convex:** The most “desired” from the point of view of calculation simplicity. They are those where any segment that joins two interior points, is totally within the polygon.
- **Concave:** Or not convex. The opposite of the above. It is one that has an interior angle of more than 180 degrees.

- **Weakly:** It is one that presents holes through “cut” segments where two vertices are duplicated to allow access and return of each hole. It is an easy way to empty the interior of regions without requiring multiple cycles. The calculation of areas and collisions will take into account these cavities.

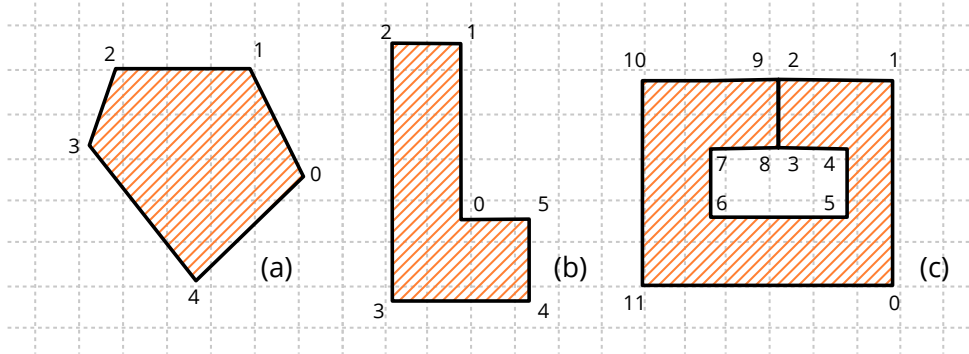

Figure 16.22: 2D polygons. (a) Convex, (b) Concave, (c) Weak. All of them defined counter-clockwise.

16.11.1. Polygon center

It is difficult to define a central point in a figure as irregular as a polygon can be. Normally we will interpret as such the centroid or **center of mass** but, in non-convex cases, this point can be located outside the polygon. In labeling tasks, it is necessary to have a representative point that is within the figure. We consider the **visual center** to be that point within the polygon located at a maximum distance from any edge (Figure 16.23). In convex polygons it will coincide with the centroid.

- Use `pol2d_centroidf` to get the centroid of the polygon.
- Use `pol2d_visual_centerf` to get the visual center of the polygon. It implements an adaptation of the **polylabel** algorithm of the MapBox¹ project.

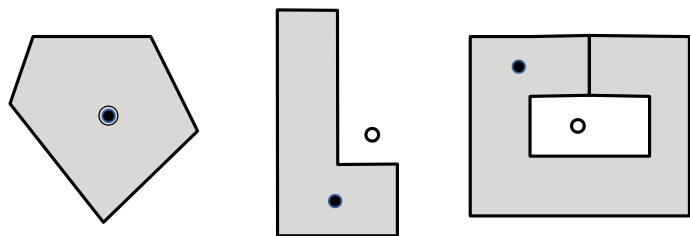

Figure 16.23: “Central” point of a polygon. Line: Centroid, Fill: Visual or Label Center.

¹<https://github.com/mapbox/polylabel>

16.11.2. Polygon decomposition

Certain calculations or rendering tasks can be considerably optimized if we reduce the complexity of the geometry to be treated. Decomposing a polygon is nothing more than obtaining a list of simpler polygons whose union is equivalent to the original figure (Figure 16.24). As an inverse operation, we would have the calculation of the **convex hull**, which is obtaining the convex polygon that encloses a set of arbitrary points (Figure 16.25).

- Use `pol2d_trianglesf` to get a list of the triangles that make up the polygon.
- Use `pol2d_convex_partitionf` to get a list of convex polygons equivalent to the polygon.
- Use `pol2d_convex_hullf` to create a convex polygon that “wraps” a set of points.

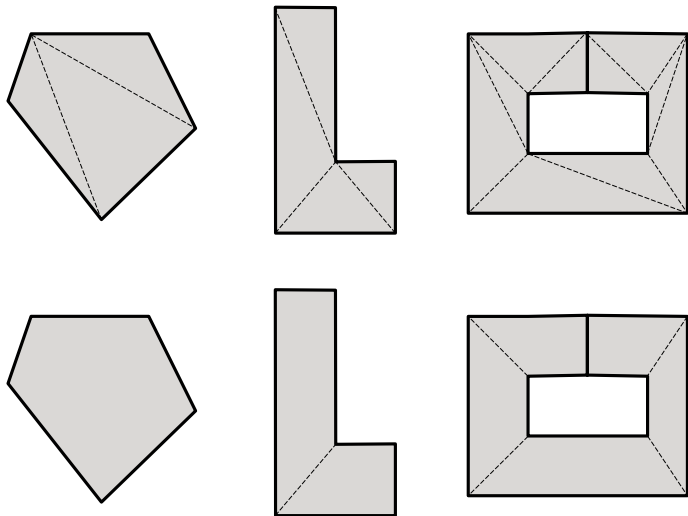

Figure 16.24: Decomposition of a polygon by triangulation or convex components.

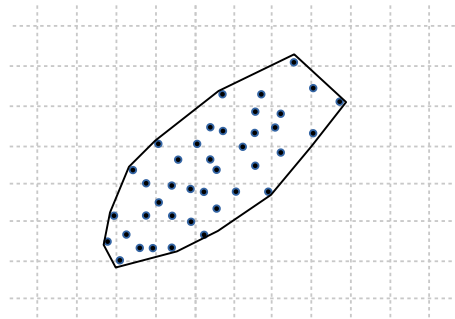

Figure 16.25: Convex hull of a set of points.

16.12. 2D Collisions

Collision detection is responsible for studying and developing algorithms that check if two geometric objects intersect at some point. As the general case would be quite complex to implement and inefficient to evaluate, a series of **collision volumes** (Figure 16.26) are defined that will enclose the original sets and where the tests can be significantly simplified. The use of these most elementary forms is usually known as *broad phase collision detection* (Figure 16.27), since it seeks to detect “non-collision” as quickly as possible. In “*Hello 2D Collisions!*” (page 677) you have an example application.

- Use `col2d_poly_obbf` to detect the collision between an oriented box and a polygon.
- Use `col2d_tri_trif` to detect the collision between two triangles.
- Use `col2d_circle_segmentf` to detect the collision between a circle and a segment.

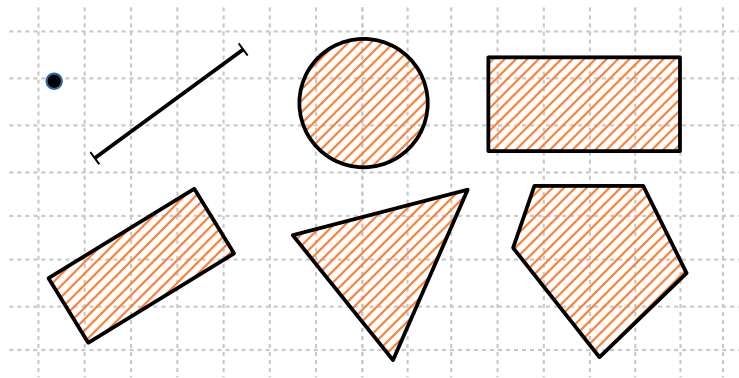

Figure 16.26: 2D Collision Volumes: Point, Segment, Circle, Box, Oriented Box, Triangle, and Polygon.

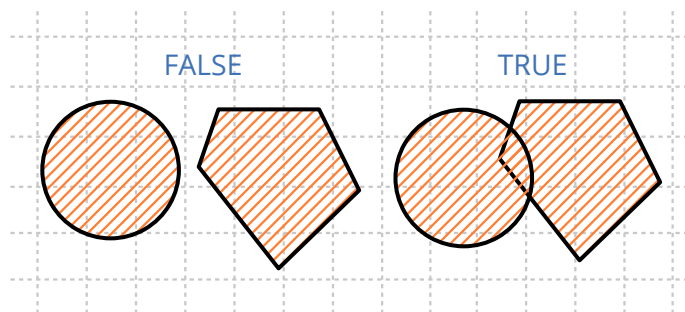

Figure 16.27: Broad phase collision detection.

Col2D provides functions to check each pair of previously presented collision volumes. Most of these methods use the **Separation Axis Theorem** (Figure 16.28). This theorem indicates, in essence, that if it is possible to find a line where the projections of the vertices do not intersect, then the figures do not intersect. In the specific case of convex polygons, it is only necessary to evaluate ***n* lines**, where *n* is the number of sides of the polygon.

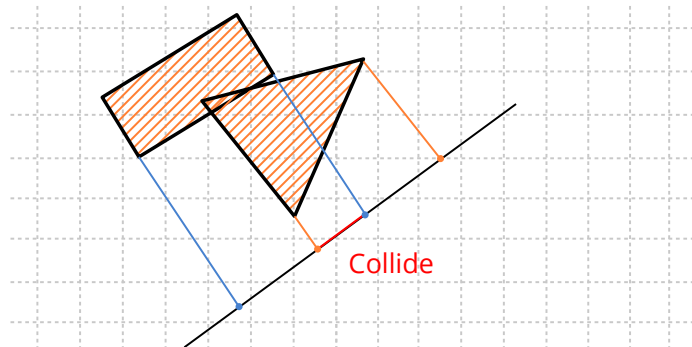

Figure 16.28: Separation axis theorem detecting a collision.

Draw2D library

17.1 Draw2D	264
17.2 2D Contexts	265
17.2.1 Reference systems	267
17.2.2 Cartesian systems	270
17.2.3 Antialiasing	271
17.2.4 Retina displays	272
17.3 Drawing primitives	273
17.3.1 Line drawing	273
17.3.2 Figures and borders	274
17.3.3 Gradients	275
17.3.4 Gradient transformation	277
17.3.5 Gradients in lines	278
17.3.6 Gradient Limits	279
17.3.7 Drawing text	279
17.3.8 Drawing images	282
17.3.9 Default parameters	283
17.4 Geom2D Entities Drawing	284
17.5 Colors	285
17.5.1 HSV space	286
17.6 Palettes	287
17.6.1 Predefined palette	288
17.7 Pixel Buffer	288
17.7.1 Pixel formats	289
17.7.2 Procedural images	290
17.7.3 Copy and conversion	291
17.8 Images	291
17.8.1 Load and view images	292

17.8.2	Generate images	293
17.8.3	Pixel access	293
17.8.4	Save images: Codecs	294
17.9	Fonts	296
17.9.1	Create fonts	296
17.9.2	System font	298
17.9.3	Monospace font	298
17.9.4	Font style	299
17.9.5	Size and metrics	300
17.9.6	Size in points	300
17.9.7	Bitmap and Outline fonts	301
17.9.8	Unicode and glyphs	302

17.1. Draw2D

The *Draw2D* library integrates all the functionality necessary to create two dimensions vector graphics. It depends directly on *Geom2D* (Figure 17.1) and, as we will see later, drawing does not imply having a graphical user interface in the program. It is possible to generate images using an internal memory buffer, without displaying the result in a window.

- “*2D Contexts*” (page 265).
- “*Drawing primitives*” (page 273).
- “*Colors*” (page 285) and “*Palettes*” (page 287).
- “*Pixel Buffer*” (page 288) and “*Images*” (page 291).
- “*Fonts*” (page 296).

This library connects directly to the native technologies of each operating system: **GDI+** on Windows systems, **Quartz2D** on macOS and **Cairo** on Linux. In essence, *draw2d* offers a common and light interface so that the code is portable, delegating the final work in each of them. With this we guarantee three things:

- Efficiency: These APIs have been tested for years and are maintained by system manufacturers.
- Presence: They are integrated as standard in all computers, so it is not necessary to install additional software.

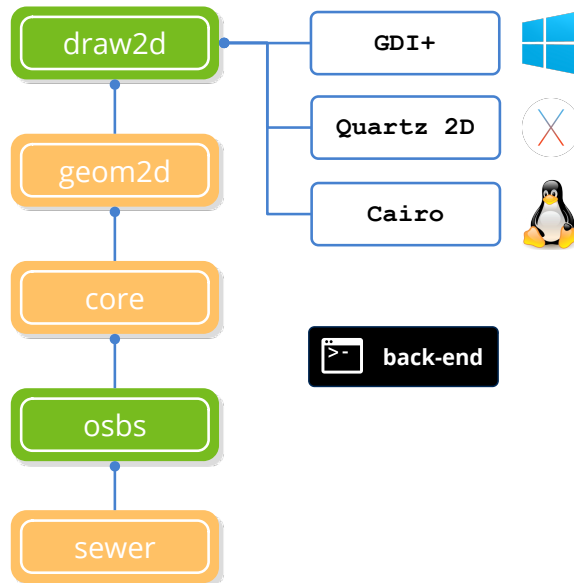

Figure 17.1: Dependencies of *draw2d*. See “NAppGUI API” (page 151).

- Performance: The programs are smaller since they do not require linking with special routines for handling graphics, typography or images.

17.2. 2D Contexts

Vector graphics are composed of basic primitives such as lines, circles, text, etc, using the painter’s algorithm (Figure 17.2): Incoming operations overlap existing ones. The result is stored in an intermediate buffer known as *canvas* or *surface*. This drawing surface is part of an object called **context** that also maintains certain parameters related to the appearance of primitives: Colors, line attributes, reference system, gradients, etc..

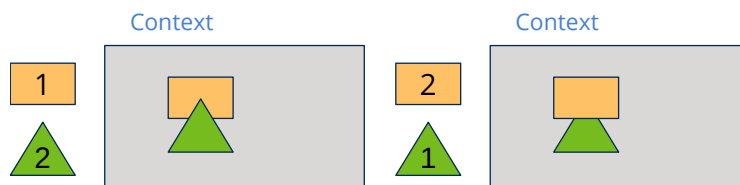

Figure 17.2: Painter’s algorithm. New objects will overlap existing ones.

One of the advantages of working with parametric shapes is that image scaling can be done without loss of quality (Figure 17.3). This is because the conversion to pixels, a process called rasterization (Figure 17.4), is done in real time and constantly adjusts to the change of vectors. In bitmap images, an increase in size has associated a loss of quality.

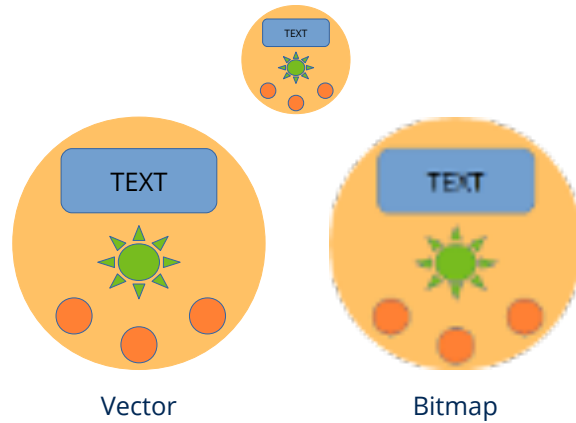

Figure 17.3: Vector scaling and bitmap scaling.

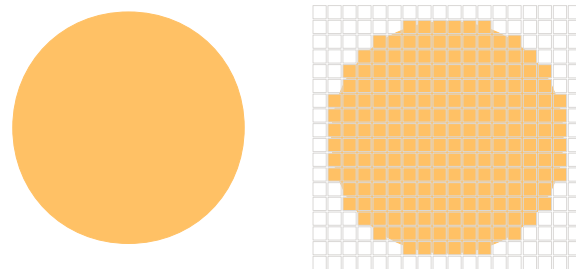

Figure 17.4: Rasterization of a circle.

Draw2D allows working with two types of 2D contexts (Figure 17.5).

- Window context. The destination will be an area within a user interface window managed by a `View` control. This control maintains its own drawing context and sends it “ready to use” through the `EvDraw` event (Listing 17.1).

Listing 17.1: Drawing in a window.

```
static void i_OnDraw(App *app, Event *e)
{
    const EvDraw *p = event_params(e, EvDraw);

    draw_clear(p->ctx, color_rgb(200, 200, 200));
    draw_fill_color(p->ctx, color_rgb(0, 128, 0));
    draw_rect(p->ctx, ekFILL, 100, 100, 200, 100);
    draw_fill_color(p->ctx, color_rgb(0, 0, 255));
    draw_circle(p->ctx, ekFILL, 450, 150, 75);
}

View *view = view_create();
view_size(view, s2df(600, 400));
view_OnDraw(view, listener(app, i_OnDraw, App));
```

- Image context. Here the drawing commands will be directly dumped into memory to subsequently obtain an image with the final result (Listing 17.2).

Listing 17.2: Draw on an image.

```

static i_draw(void)
{
    Image *image = NULL;
    DCtx *ctx = dctx_bitmap(600, 400, ekRGBA32);

    draw_clear(ctx, color_rgb(200, 200, 200));
    draw_fill_color(ctx, color_rgb(0, 128, 0));
    draw_rect(ctx, ekFILL, 100, 100, 200, 100);
    draw_fill_color(ctx, color_rgb(0, 0, 255));
    draw_circle(ctx, ekFILL, 450, 150, 75);

    image = dctx_image(&ctx);
    image_to_file(image, "drawing.png", NULL);
    image_destroy(&image);
}

```

Figure 17.5: Window and image contexts.

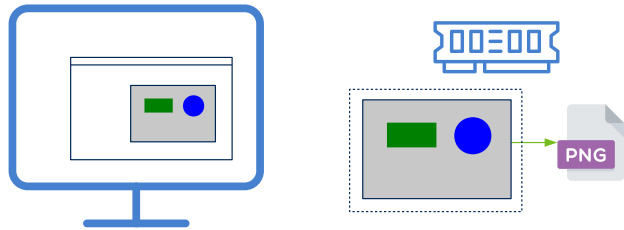

As we can see, the drawing itself is done in the same way, the only thing that changes is how we obtained the context (`DCtx`). This allows us to write generic graphic routines without worrying about the destination of the final result. In the example *DrawImg*¹ you have a practical step-by-step development of the use of contexts. The images that accompany the rest of the chapter have been obtained from this application.

Because it is not necessary to have a window to draw, Draw2d can be used in console applications to compose or edit images in an automated way.

17.2.1. Reference systems

The drawing origin of coordinates is located in the upper left corner (Figure 17.6). The positive **X** move to the left and the positive **Y** down. Units are measured in pixels (or points in “*Retina displays*” (page 272)). For example, the command:

```
draw_circle(ctx, ekSKFILL, 300, 200, 100);
```

¹<https://nappgui.com/en/howto/drawing.html>

will draw a circle of 100 pixel radius whose center is 300 pixels to the left and 200 pixels down from the origin. This initial system is called **identity** since it has not yet been manipulated, as we will see below.

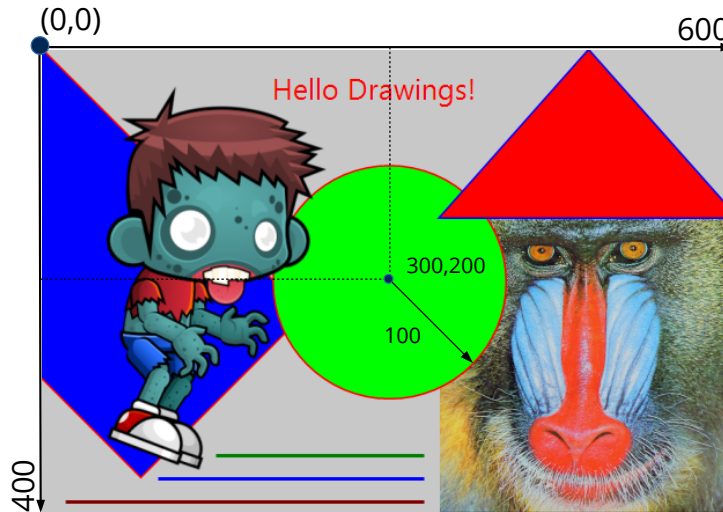

Figure 17.6: Identity reference system in 2D contexts.

Although the initial scale is in pixels, we must banish the idea that we are directly manipulating pixels when drawing. Drawing contexts use floating point coordinates. For example, drawing a line between the points $(0.23, 1.432)$ and $(-45.29, 12.6756)$ is perfectly valid. Transformations and antialiasing may slightly alter the position or thickness of certain lines. Nor should we expect “identical” pixel-level results when migrating applications to different platforms, since each system uses its own rasterization algorithms. We must think that we are drawing on the real plane. To directly manipulate the pixels of an image, see `image_pixels` and `image_from_pixels`.

This initial reference system can be manipulated by “2D Transformations” (page 249). The most common transformations in graphics are: Translations (Figure 17.7), Rotations (Figure 17.8) and Scaling (Figure 17.9).

- `draw_matrixf` will change the context reference system.

Listing 17.3: Coordinate origin translation 100 units in both directions.

```
T2Df t2d;
t2d_movef(&t2d, kT2D_IDENTf, 100, 100);
draw_matrixf(ctx, &t2d);
i_draw(...);
```

Listing 17.4: Coordinate origin rotation 15 degrees.

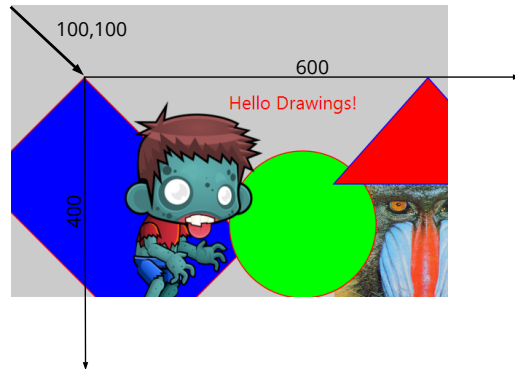

Figure 17.7: Translation (Listing 17.3).

```
T2Df t2d;
t2d_rotatef(&t2d, kT2D_IDENTf, 15 * kBMATH_DEG2RADf);
draw_matrixf(ctx, &t2d);
i_draw(...);
```

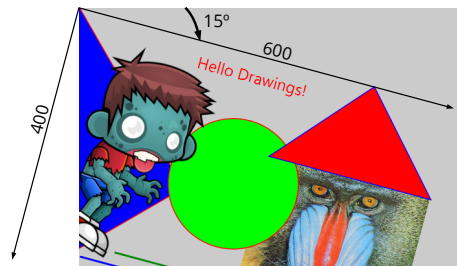

Figure 17.8: Rotation (Listing 17.4).

Listing 17.5: Scaling, size halving.

```
T2Df t2d;
t2d_scalef(&t2d, kT2D_IDENTf, .5f, .5f);
draw_matrixf(ctx, &t2d);
i_draw(...);
```

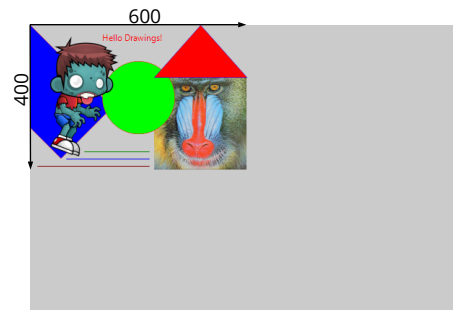

Figure 17.9: Scaling (Listing 17.5).

The transformations can be accumulated, but we must bear in mind that they are not commutative operations, but that the order in which they are applied will influence the

final result. For example in (Figure 17.10) we observe that the drawing has moved (100, 50) pixels, instead of (200, 100), because the translation is affected by previous scaling. More details at “*Composition of transformations*” (page 250).

Listing 17.6: Composition of transformations.

```
T2Df t2d;
t2d_scalef(&t2d, kT2D_IDENTf, .5f, .5f);
t2d_movef(&t2d, &t2d, 200, 100);
t2d_rotatef(&t2d, &t2d, 15 * kBMAH_DEG2RADf);
draw_matrixf(ctx, &t2d);
i_draw(...);
```

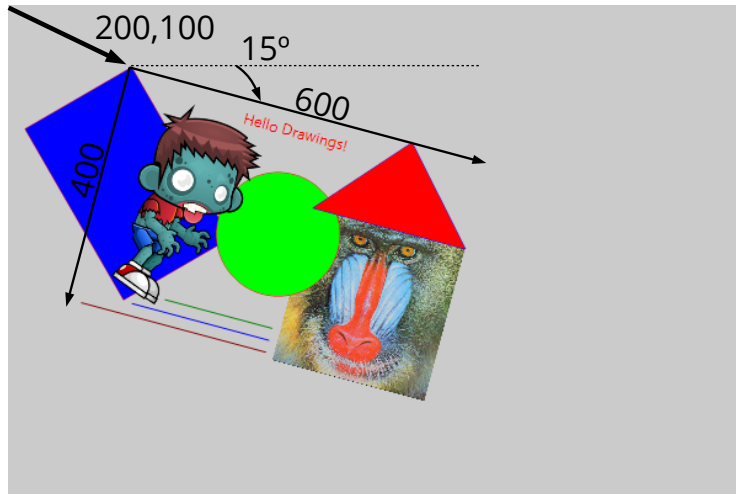
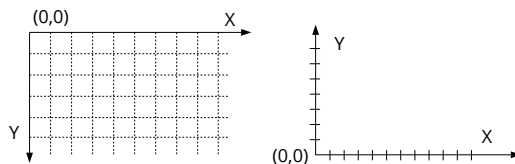

Figure 17.10: Composition of transformations (Listing 17.6).

17.2.2. Cartesian systems

There is a dichotomy when drawing in 2D: On the one hand, traditionally desktop systems and digital images place the origin of coordinates in the upper left corner with the Y axis growing down (Figure 17.11). On the other hand, the Cartesian systems used in geometry place it in the lower left corner, with Y growing up. This creates a dilemma about whether one system is better than another.

Figure 17.11: 2D system on monitors (left) and Cartesian (right).



The answer is clearly no. Even in the same drawing, we may need to combine both depending on the element we are treating. For texts and images, the screen system is more

intuitive since it reproduces the paper or canvas of the physical world. For mathematical functions, bar graphs, plans and other aspects related to the technical world, the Cartesian is much more comfortable and natural.

- `draw_matrix_cartesianf` set the context reference system in Cartesian coordinates. In (Figure 17.12) we have used a 6x4 unit Cartesian system mapped onto a 600x400 pixel window.

Listing 17.7: Drawing in Cartesian coordinates.

```
T2Df t2d;
draw_line_color(ctx, color_rgb(255, 0, 0));
draw_line_width(ctx, .03);
draw_fill_color(ctx, color_rgb(0, 0, 255));
t2d_scalef(&t2d, kt2D_IDENTf, 100, 100);
draw_matrix_cartesianf(ctx, &t2d);
draw_rect(ctx, ekSKFILL, 1.5f, .1f, 1, 2);
draw_line_color(ctx, color_rgb(0, 128, 0));
draw_line(ctx, 0, 0, 1.5f, 2.1f);
```

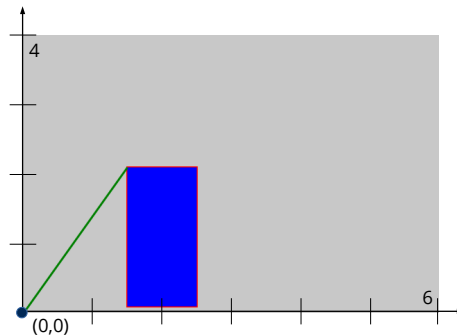

Figure 17.12: Cartesian coordinates (Listing 17.7).

17.2.3. Antialiasing

Given the discrete nature of monitors and digital images, a staggered effect (sawtooth) is produced by transforming vector primitives to pixels (Figure 17.13). This effect becomes less noticeable as the resolution of the image increases, but still the “pixelated” remains patent. The **antialiasing**, is a technique that reduces this step effect by slightly varying the colors of the pixels in the environment near the lines and contours (Figure 17.14). With this, the human eye can be deceived by blurring the edges and generating images of greater visual quality. In return we have the cost in the performance of applying it, although for years that the calculations related to antialiasing are made directly in hardware (Figure 17.15), so the impact will be minimal.

- `draw_antialias` allows to activate or deactivate the antialiasing calculations.

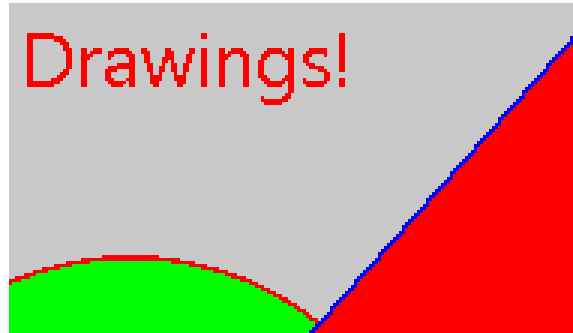

Figure 17.13: Antialiasing off.



Figure 17.14: Antialiasing on.

Figure 17.15: Orchid Fahrenheit 1280 (1992). One of the first cards that incorporated 2d graphic acceleration.



17.2.4. Retina displays

At the end of 2014 Apple introduced its new iMac with high resolution *Retina Display* (5120x2880). Normally, these monitors work in **scaled** mode (2560x1440) allowing double density pixels (Figure 17.16). Apple differentiates between **points** on the screen, which are what really manipulates the application and physical pixels. Therefore, our 600x400 window will really have 1200x800 pixels on Retina computers, although the application will still “see” only 600x400 points. The operating system converts transparently. In fact, we don’t have to do anything to adapt our code, since it will work in the same way on both normal iMac and those equipped with Retina monitors.

This double density will be used by the rasterizer to generate higher quality images by having more pixels in the same screen area. In (Figure 17.17) and (Figure 17.18) we see the extra quality that these models provide.

Figure 17.16: Double density pixels on *Retina Display* (right).

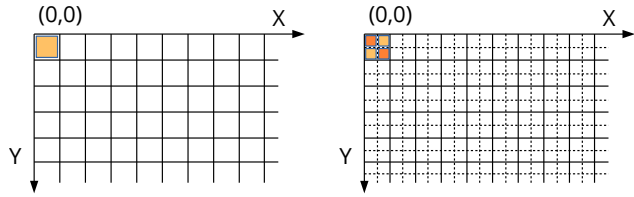

Figure 17.17: Normal screen (with antialiasing).



Figure 17.18: *Retina Display* (with antialiasing).



17.3. Drawing primitives

When drawing in 2D contexts we have a series of elementary shapes such as lines, figures, text and images. In *DrawHello*² you have the source code of the application that will accompany us throughout this section.

17.3.1. Line drawing

The most elementary operation is to draw a line between two points. In 2d contexts the lines are solid objects and not a mere row of pixels. Let's think we are using thick tip pens, where the theoretical line will always remain in the center of the stroke (Figure 17.19). We can change the shape of the endings (linecap), the joints (linejoin) and establish a pattern for dashed lines.

²<https://nappgui.com/en/howto/drawhello.html>

- `draw_line` will draw a line.
- `draw_polyline` will draw several connected lines.
- `draw_arc` will draw an arc.
- `draw_bezier` will draw a Bézier curve of degree 3 (cubic).
- `draw_line_color` will set the line color.
- `draw_line_width` set the line width.
- `draw_line_cap` set the style of the ends.
- `draw_line_join` set the style of the unions.
- `draw_line_dash` set a dot pattern for dashed lines.

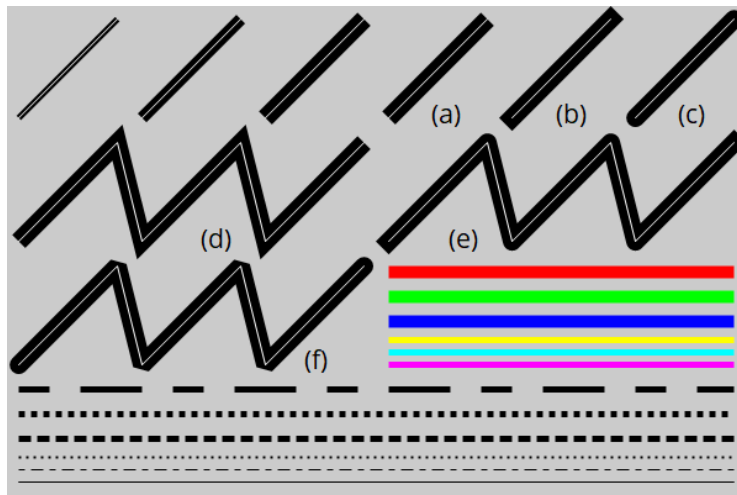

Figure 17.19: Different line styles. (a) `ekLCFLAT`. (b) `ekLCSQUARE`. (c) `ekLCROUND`. (d) `ekLJMITER`. (e) `ekLJROUND`. (f) `ekLJBEVEL`. The pattern: `[5, 5, 10, 5]`, `[1, 1]`, `[2, 1]`, `[1, 2]`, `[5, 5, 10, 5]`, `NULL`.

17.3.2. Figures and borders

To draw figures or closed areas we have several commands. As we see in (Figure 17.20) we can draw the outline of the figure, its interior or both. For the contour, the established line style will be taken into account as we have seen in the previous section.

- `draw_rect` for rectangles.
- `draw_rndrect` for rectangles with rounded edges.
- `draw_circle` for circles.

- `draw_ellipse` for ellipses.
- `draw_polygon` for polygons.
- `draw_fill_color` set the area fill color.

Listing 17.8: Drawing of figures (outlines and/or fills).

```
draw_fill_color(ctx, kCOLOR_BLUE);
draw_line_color(ctx, kCOLOR_BLACK);
draw_rect(ctx, ekSTROKE, 10, 10, 110, 75);
draw_rndrect(ctx, ekFILL, 140, 10, 110, 75, 20);
draw_circle(ctx, ekSKFILL, 312, 50, 40);
draw_ellipse(ctx, ekFILLSK, 430, 50, 55, 37);
```

As we saw in “2D Contexts” (page 265), the order in which the operations are performed matters. It is not the same to fill and then draw the outline as vice versa. The center of the stroke will coincide with the theoretical contour of the figure.

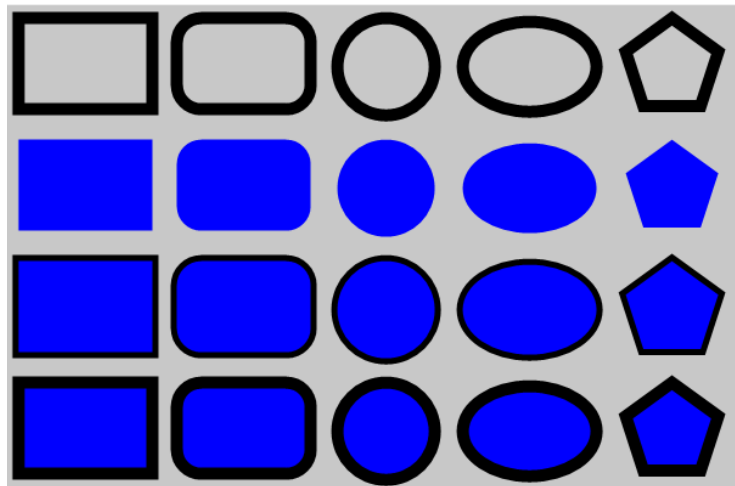

Figure 17.20: Stroke only `ekSTROKE`. Fill only `ekFILL`. First stroke, then fill `ekSKFILL`. First fill, then stroke `ekFILLSK`.

17.3.3. Gradients

Gradients allow regions to be filled using a gradient instead of a solid color (Figure 17.21). Several base colors and their relative position along a vector are defined (Listing 17.9). The positions $[0, 1]$ correspond to the extremes and the values within this range to the possible intermediate stops. Each line perpendicular to the vector defines a uniform color that will extend indefinitely until reaching the limits of the figure to be filled.

- Use `draw_fill_linear` to activate the fill with gradients.
- Use `draw_fill_color` to return to solid color fill.

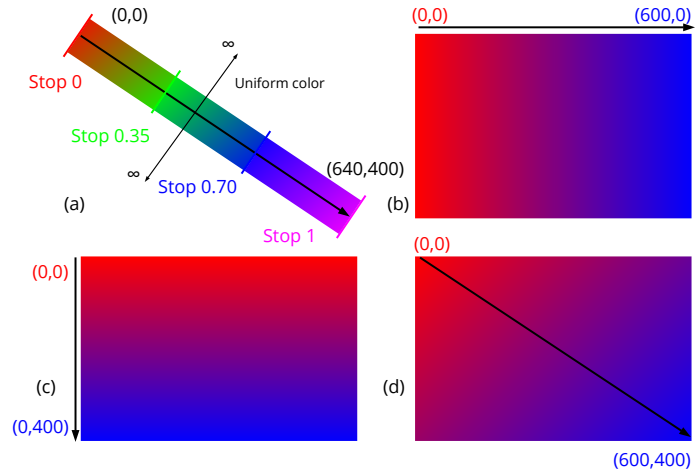

Figure 17.21: Linear gradients. The color is interpolated along a vector.

Listing 17.9: Definition of (Figure 17.21) gradients.

```
// (a) Gradient
color_t color[4];
real32_t stop[4] = {0, .35f, .7f, 1};
color[0] = color_rgb(255, 0, 0);
color[1] = color_rgb(0, 255, 0);
color[2] = color_rgb(0, 0, 255);
color[3] = color_rgb(255, 0, 255);
draw_fill_linear(ctx, color, stop, 4, 0, 0, 600, 400);

// (b) Gradient
color_t color[2];
real32_t stop[2] = {0, 1};
color[0] = color_rgb(255, 0, 0);
color[1] = color_rgb(0, 0, 255);
draw_fill_linear(ctx, color, stop, 2, 0, 0, 600, 0);

// (c) Gradient
color_t color[2];
real32_t stop[2] = {0, 1};
color[0] = color_rgb(255, 0, 0);
color[1] = color_rgb(0, 0, 255);
draw_fill_linear(ctx, color, stop, 2, 0, 0, 0, 400);

// (d) Gradient
color_t color[2];
real32_t stop[2] = {0, 1};
color[0] = color_rgb(255, 0, 0);
color[1] = color_rgb(0, 0, 255);
draw_fill_linear(ctx, color, stop, 2, 0, 0, 600, 400);
```

17.3.4. Gradient transformation

Since the gradient is defined by a vector, it is possible to set a transformation that changes the way it is applied. This matrix is totally independent from the one applied to drawing primitives `draw_matrixf`, as we saw in “*Reference systems*” (page 267).

- Use `draw_fill_matrix` to set the gradient transformation. With this we can get several effects:
- **Global gradient:** The gradient will be applied globally to the background, and the figures will be cutouts of the same pattern (Figure 17.22). To do this we will set the identity matrix as a gradient transformation (Listing 17.10). It is defined by default.

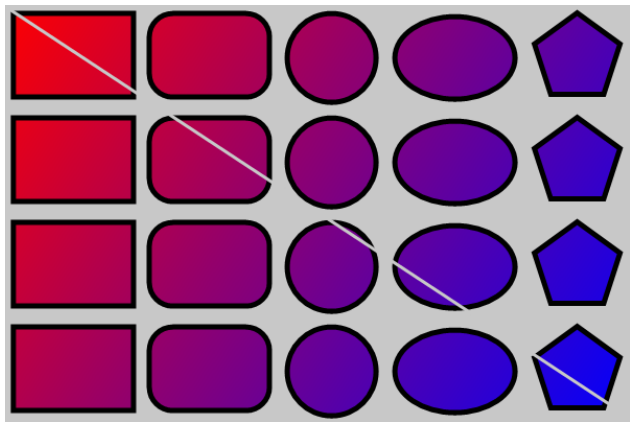

Figure 17.22: Global gradient. The continuity between figures is not lost.

Listing 17.10: Gradient matrix for the whole drawing.

```
draw_fill_linear(ctx, c, stop, 2, 0, 0, 600, 400);
draw_fill_matrix(ctx, kT2D_IDENTf);
i_draw_shapes(ctx);
```

- **Local gradient:** The vector is transferred to the origin of the figure or to a point in its near surroundings (Figure 17.23). With this, we will be able to apply the gradient locally and that only affects a specific figure. In (Listing 17.11) we have slightly varied the transformation to fix the origin in a corner and not in the center of the ellipse. This may vary depending on the desired effect.

Listing 17.11: Gradient matrix for a figure.

```
T2Df t2d;
t2d_movef(&t2d, kT2D_IDENTf, 250, 280);
t2d_rotatef(&t2d, &t2d, - kBMATH_PIf / 10);
draw_matrixf(ctx, &t2d); // Geometry matrix
draw_fill_linear(ctx, c, stop, 2, 0, 0, 200, 100);
t2d_movef(&t2d, &t2d, -100, -50);
draw_fill_matrix(ctx, &t2d); // Gradient matrix
draw_ellipse(ctx, eSKFILL, 0, 0, 100, 50);
```

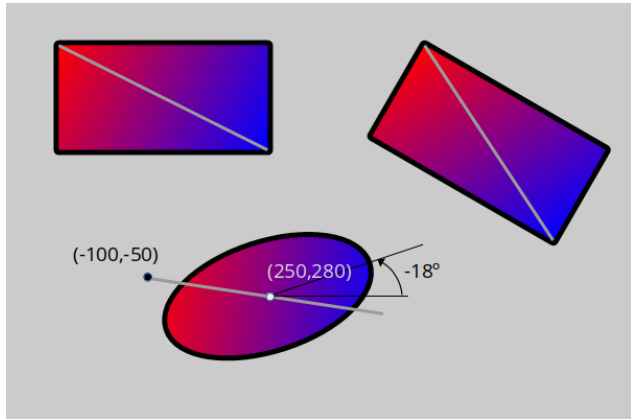

Figure 17.23: Local gradient. The origin is placed in the figure.

17.3.5. Gradients in lines

In addition to region fill, gradients can also be applied to lines and contours (Figure 17.24) (Listing 17.12).

- Use `draw_line_fill` to draw the lines with the current fill pattern.
- Use `draw_line_color` to return to solid color.

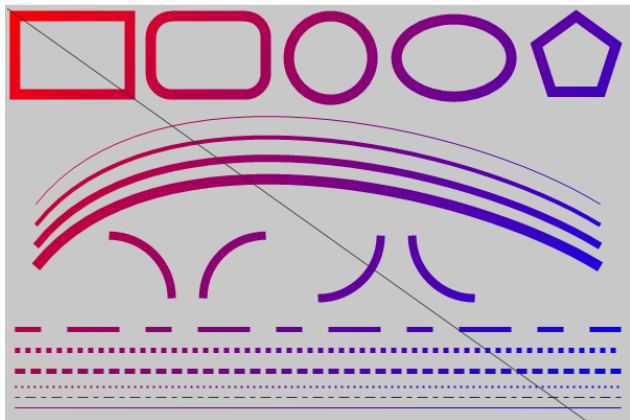

Figure 17.24: Drawing lines using gradients.

Listing 17.12: Gradients in lines.

```
draw_fill_linear(ctx, c, stop, 2, 0, 0, 600, 400);
draw_fill_matrix(ctx, kT2D_IDENTf);
draw_line_fill(ctx);
draw_bezier(ctx, 30, 200, 140, 60, 440, 120, 570, 200);
```

17.3.6. Gradient Limits

As we have said, the color fill will spread evenly and indefinitely along all the lines perpendicular to the vector, but... What happens outside its limits? In (Listing 17.13) (Figure 17.25) the gradient has been defined in $x=[200, 400]$, this measure being lower than the figure to be filled:

- Use `draw_fill_wrap` to define the behavior of the gradient out of bounds.
- `ekFCLAMP` the end value is used as a constant in the outer area.
- `ekFTILE` the color pattern is repeated.
- `ekFFLIP` the pattern is repeated, but reversing the order which prevents the loss of continuity in color.

Listing 17.13: Uniform color outside the limits of the gradient (Figure 17.25) (a).

```
draw_fill_linear(ctx, c, stop, 2, 200, 0, 400, 0);
draw_fill_wrap(ctx, ekFCLAMP);
draw_rect(ctx, ekFILLSK, 50, 25, 500, 100);
```

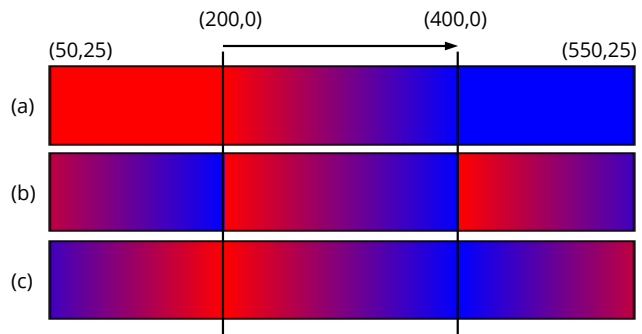

Figure 17.25: Limit Behavior:
(a) `ekFCLAMP`, (b) `ekFTILE`, (c)
`ekFFLIP`.

17.3.7. Drawing text

Text rendering is the most important part of the user interface. In the old days, small *bitmaps* were used with the image of each character, but in the early 90's vector fonts based on Bezier curves came into play. The large number of fonts, the immense set of “Unicode” (page 161) characters and the possibility of scaling, rotating, or layout the text in paragraphs was a great technical challenge in those years. Fortunately, all this casuistry is largely solved by the native APIs of each operating system, which allows us to provide a simplified interface to add text to our drawings..

- Use `draw_text` to draw texts in 2D contexts.
- Use `draw_text_color` to set the color of the text.
- Use `draw_font` to set the font.

- Use `draw_text_width` to set the maximum width of a block of text.
- Use `draw_text_trim` to indicate how the text will be cut.
- Use `draw_text_align` to set the alignment of a text block.
- Use `draw_text_halign` to set the internal alignment of the text.
- Use `draw_text_extents` to get the size of a block of text.

To draw single-line texts, we just have to call the function, passing a UTF8 string (Listing 17.14) (Figure 17.26). Previously, we can assign the font, color and alignment.

Listing 17.14: Dibujo de una línea de texto.

```
Font *font = font_system(20, 0);
draw_font(ctx, font);
draw_text_color(ctx, kCOLOR_BLUE);
draw_text_align(ctx, ekLEFT, ekTOP);
draw_text(ctx, "Text □□Κείμενο ", 25, 25);
```

Figure 17.26: Single-line texts, with alignment and transformations.



If the string to be displayed has new lines (character `'\n'`) they will be taken into account and the text will be shown in several lines (Listing 17.15) (Figure 17.27). We can also obtain the measure in pixels of a block, useful to integrate the text with other primitives.

Listing 17.15: Dibujo de textos con saltos de línea.

```
const char_t *text = "Text new line\n□□□□n\Γροαμμήν κειμένον";
real32_t w, h;
draw_text(ctx, text, 25, 25);
draw_text_extents(ctx, text, -1, &w, &h);
```

If the text does not contain new lines, it will be drawn continuously expanding horizontally. This may not be the most appropriate in long paragraphs, so we can set a maximum width, forcing its drawing in several lines (Listing 17.16) (Figure 17.28).



Figure 17.27: Texts with a '\n' character.

Listing 17.16: Maximum width and internal alignment in text blocks.

```
const char_t *text = "Lorem ipsum dolor sit amet...consequat";
draw_text_width(ctx, 200);
draw_text_halign(ctx, ekLEFT);
draw_text(ctx, text, 25, 25);
draw_text_extents(ctx, text, 200, &w, &h);
```

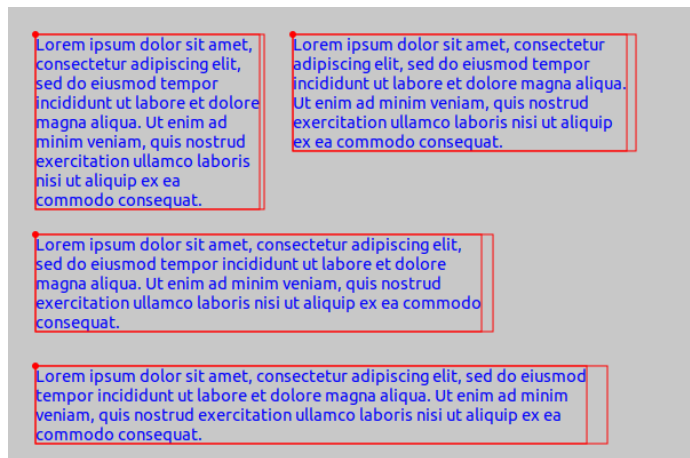

Figure 17.28: Text paragraphs with width limit. The maximum and real width obtained with `draw_text_extents` are shown.

Finally, we can use `draw_text_path` to treat the text like any other geometric region, highlighting the border or filling with gradients. In this case `draw_text_color` will have no effect and the values of `draw_fill_color`, `draw_fill_linear` and `draw_line_color` will be used (Listing 17.17) (Figure 17.29).

Listing 17.17: Text with dotted stroke and gradient fill.

```
color_t c[2];
real32_t stop[2] = {0, 1};
real32_t dash[2] = {1, 1};
c[0] = kCOLOR_BLUE;
```

```

c[1] = kCOLOR_RED;
draw_line_dash(ctx, dash, 2);
draw_line_color(ctx, kCOLOR_GREEN);
draw_text_extents(ctx, "Gradient dashed text", -1, &w, &h);
draw_fill_linear(ctx, c, stop, 2, 25, 0, 25 + w, 0);
draw_text_path(ctx, ekFILLSK, "Gradient dashed text", 25, 250);

```

Fill and Stoke text
Gradient fill text
Dashed stroke text
Gradient dashed text
Thin stroke text

Figure 17.29: Combining fill and stroke.

draw_text is much faster than draw_text_path, so we must limit the use of the latter to what is strictly necessary.

17.3.8. Drawing images

Images generated procedurally or read from disk can be used as a drawing primitive more (Listing 17.18) (Figure 17.30). As with text or other figures, the transformation of the context will affect the geometry of the image.

- Use `draw_image` to draw an image.
- Use `draw_image_frame` to draw a sequence of an animation.
- Use `draw_image_align` to set the alignment of the image with respect to the insertion point.

Listing 17.18: Translated and rotated image drawing.

```

const Image *image = image_from_resource(pack, IMAGE_JPG);
T2Df t2d;
t2d_movef(&t2d, kT2D_IDENTf, 300, 200);
t2d_rotatef(&t2d, &t2d, kBMATH_PIf / 8);
draw_image_align(ctx, ekCENTER, ekCENTER);
draw_matrixf(ctx, &t2d);
draw_image(ctx, image, 0, 0);

```



Figure 17.30: Drawing images with alignment.

17.3.9. Default parameters

Each context maintains certain state parameters. At the beginning of the drawing, either by the method `OnDraw` or after creating the context with `dctx_bitmap` the default values are those shown in (Table 17.1):

Parameter	Value	Change with
Matrix	Identity (0,0) Sup-Left corner, pixels.	<code>draw_matrixf</code>
Antialiasing	<code>TRUE</code>	<code>draw_antialias</code>
LineColor	<code>kCOLOR_BLACK</code>	<code>draw_line_color</code>
LineWidth	1	<code>draw_line_width</code>
Linecap	<code>ekLCFLAT</code>	<code>draw_line_cap</code>
Linejoin	<code>ekLJMITER</code>	<code>draw_line_join</code>
LineDash	Sólido	<code>draw_line_dash</code>
TextColor	<code>kCOLOR_BLACK</code>	<code>draw_text_color</code>
FillColor	<code>kCOLOR_BLACK</code>	<code>draw_fill_color</code>
FillMatrix	Identity (0,0) Sup-Left corner, pixels.	<code>draw_fill_matrix</code>
Font	System default, regular size.	<code>draw_font</code>
Text max width	-1	<code>draw_text_width</code>

Parameter	Value	Change with
Text vertical align	<code>ekLEFT</code>	<code>draw_text_align</code>
Text horizontal align	<code>ekTOP</code>	<code>draw_text_align</code>
Text internal align	<code>ekLEFT</code>	<code>draw_text_halign</code>
Image vertical align	<code>ekLEFT</code>	<code>draw_image_align</code>
Image horizontal align	<code>ekTOP</code>	<code>draw_image_align</code>

Table 17.1: Default values in 2D contexts.

17.4. Geom2D Entities Drawing

In the previous section we have seen the basic primitives for drawing in 2D. However, *Draw2D* has specialized functions for “*Geom2D*” (page 243) objects. These new functions would be totally dispensable, since you could get the same result using `draw_rect`, `draw_polygon`, etc. They are included as a mere shortcut, in addition to offering a version of them based on “*Math templates*” (page 53), very useful when developing generic algorithms in C++. The line and fill properties will be those that are in effect at any given time within the context, due to: `draw_line_color`, `draw_line_width`, `draw_fill_color`, etc..

- Use `draw_v2df` to draw a point.
- Use `draw_seg2df` to draw a segment.
- Use `draw_cir2df` to draw a circle.
- Use `draw_box2df` to draw an aligned box.
- Use `draw_obb2df` to draw an oriented box.
- Use `draw_tri2df` to draw a triangle.
- Use `draw_pol2df` to draw a polygon.

You can find a complete example of the use of 2D entities in *Col2DHello*³ (Figure 17.31). In addition to drawing, this application shows other concepts related to graphics and geometric calculation such as:

- Create 2D objects on demand.
- *Click+Drag* interactivity.
- Collision detection.

³<https://nappgui.com/en/howto/col2dhello.html>

- Calculation of areas.
- Triangulation of polygons and decomposition into convex components.
- Calculation of the optimal circle that surrounds a set of points.
- Calculation of the oriented box (OBB2Df) that best represents a set of points.
- Calculation of the Convex Hull.

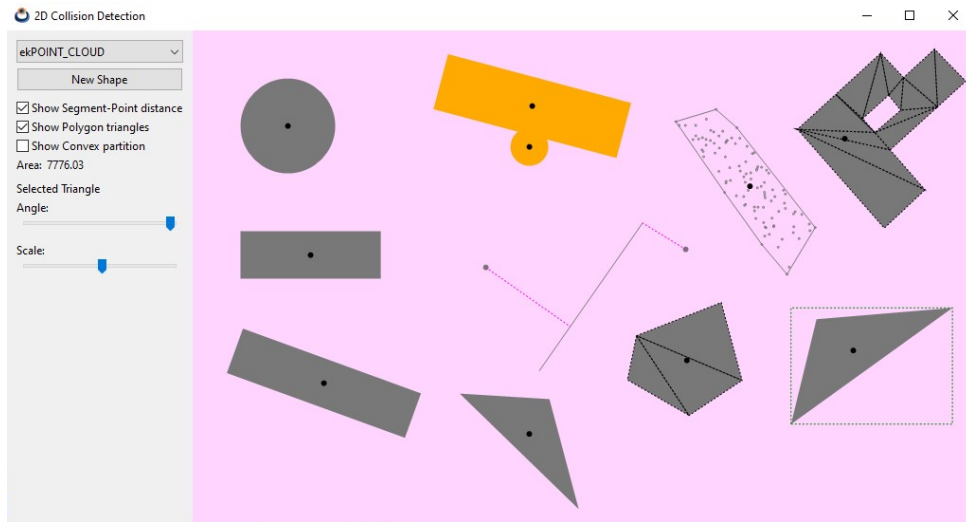

Figure 17.31: *Col2dHello* application, which illustrates how to work with 2D geometry.

17.5. Colors

The colors in Draw2D are encoded using a 32-bit integer with the four RGBA channels in Little-Endian: Red in byte 0, green in 1, blue in 2 and alpha (or transparency) in 3 (Figure 17.32). The alias `color_t` is used as an equivalent to `uint32_t`. In the particular case that byte 3 is equal to 0 (fully transparent), the first three bytes will not contain RGB information, but an index with a special color.

- Use `color_rgba` to create a color using its RGBA components.
- Use `color_get_rgba` to get the RGBA components.
- Use `color_html` to translate an string into HTML format ("`#RRGGBB`").
- Use `kCOLOR_BLACK` and others to access predefined basic colors.

Figure 17.32: 32-bit RGBA value representation.

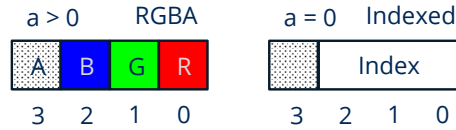

17.5.1. HSV space

RGB representation is based on the addition of the three primary light colors. It is the most widespread within the generation of computer images, especially when calculating shading and reflections. It is also used in TV, monitors or projectors where each pixel is obtained by combining the light of three emitters. However, it is very unintuitive for human color editing. For example, given a color in RGB, it is very difficult to increase the brightness or vary the tone (between red and orange, for example) by manipulating the triplet (r, g, b). The HSV space (*Hue*, *Saturation*, *Value*) also called HSB (*Brightness*) solves this problem, since the effect of altering this group of values will be highly predictable (Figure 17.33).

- Use `color_hsb` to create an RGB color from its components **H**, **S**, **B**.
- Use `color_to_hsb` to get the **H**, **S**, **B** components.

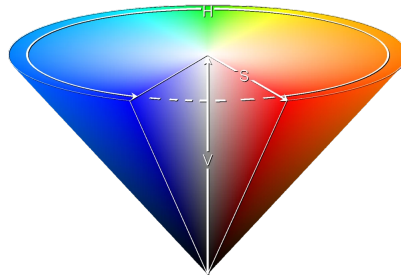

Figure 17.33: HSV space represented by an inverted cone. As V decreases, so will the number of colors available.

- **Hue:** Continuous cyclical value between 0 and 1. Where 0=Red, 1/3=Green, 2/3=Blue, 1=Red (Table 17.2).
- **Saturation:** It is equivalent to adding white paint to the base tone. When $s=1$ no white is added (maximum saturation, pure color). But if $s=0$ we will have a pure white, regardless of the tone.
- **Brightness:** It is equivalent to adding black paint to the HS combination. If $B=1$ no black is added (maximum brightness). If $B=0$ we will have a pure black, regardless of the hue and saturation.

RGB			HSV
(0,0,0)	■	<code>kCOLOR_BLACK</code>	(?,?,0)





RGB			HSV
(1,1,1)		kCOLOR_WHITE	(?,0,1)
(1,0,0)		kCOLOR_RED	(0,1,1)
(1,1,0)		kCOLOR_YELLOW	(1/6,1,1)
(0,1,0)		kCOLOR_GREEN	(1/3,1,1)
(0,1,1)		kCOLOR_CYAN	(1/2,1,1)
(0,0,1)		kCOLOR_BLUE	(2/3,1,1)
(1,0,1)		kCOLOR_MAGENTA	(5/6,1,1)

Table 17.2: Equivalence RGB/HSV.

Unlike RGB, HSVs are not totally independent. As we reduce the brightness, the number of colors of the same tone will decrease until we reach $B=0$ where we will have pure black regardless of H and S . On the other hand, if $s=0$ H will be overridden and we will have the different shades of gray as B changes from 0 (black) to 1 (white).

17.6. Palettes

A palette is nothing more than an indexed list of colors (Figure 17.34), usually related to “*Pixel Buffer*” (page 288). Its main utility is to save space in the images representation, since each pixel is encoded by an index of 1, 2, 4 or 8 bits instead of the real color where 24 or 32 bits are necessary. For this reason, it is usual to have palettes of 2, 4, 16 or 256 colors.

- Use `palette_create` to create a palette.
- Use `palette_colors` to access the elements.

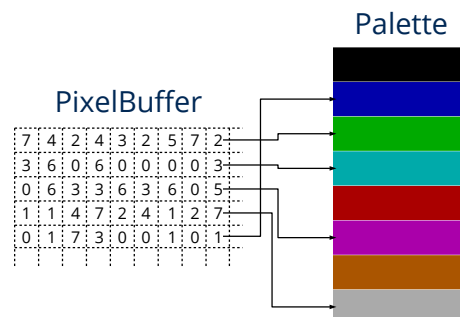

Figure 17.34: Palette associated with an indexed pixel buffer.

17.6.1. Predefined palette

We have several predefined palettes both in color (Figure 17.35) and in grays (Figure 17.36). The RGB8 palette has been created by combining 8 tones of red (3bits), 8 tones of green (3bits) and 4 tones of blue (2bits). This is so because the human eye distinguishes much less the variation of blue than the other two colors.

- Use `palette_ega4` to create a predefined palette of 16 colors.
- Use `palette_rgb8` to create a 256 color palette.
- Use `palette_gray4` and similars to create a palette in grays.
- Use `palette_binary` for a two-color palette.

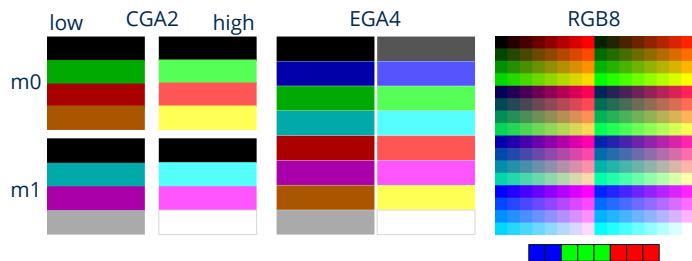

Figure 17.35: Predefined color palettes.

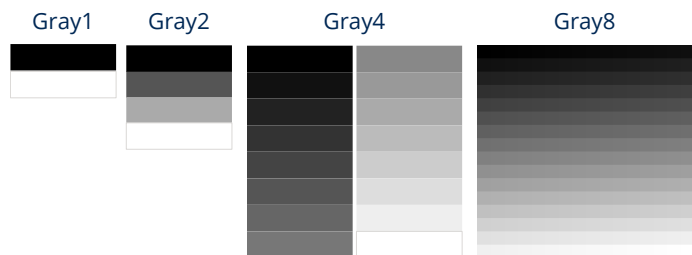

Figure 17.36: Predefined gray palettes.

17.7. Pixel Buffer

A **pixel buffer** (`Pixbuf`) is a memory area that represents a grid of color dots or pixels. They allow direct access to information but are not optimized for drawing on the screen, so we must create an `Image` object to view them. They are very efficient for procedural generation or the application of filters, since reading or writing a value does not require more than accessing its position within the buffer.

- Use `pixbuf_create` to create a new pixel buffer.
- Use `image_pixels` to get the pixels of an image.
- Use `pixbuf_width` to get the width of the grid.

- Use `pixbuf_height` to get the height of the grid.

All operations on pixel buffers are performed on the CPU. They are efficient to the extent that we directly access memory, but they cannot be compared with alternatives that use the GPU for digital image processing.

17.7.1. Pixel formats

The format refers to how the value of each pixel is encoded within the buffer (Table 17.3) (Figure 17.37).

- Use `pixbuf_format` to get the pixel format.
- Use `pixbuf_format_bpp` to get the number of bits wanted for each pixel.

Value	Description
<code>ekRGB24</code>	<i>True color</i> +16 million simultaneous, 24 bits per pixel.
<code>ekRGBA32</code>	<i>True color</i> with alpha channel (transparencies), 32 bits per pixel.
<code>ekGRAY8</code>	256 shades of gray, 8 bits per pixel.
<code>ekINDEX1</code>	Indexed, 1 bit per pixel.
<code>ekINDEX2</code>	Indexed, 2 bits per pixel.
<code>ekINDEX4</code>	Indexed, 4 bits per pixel.
<code>ekINDEX8</code>	Indexed, 8 bits per pixel.

Table 17.3: Pixel formats.

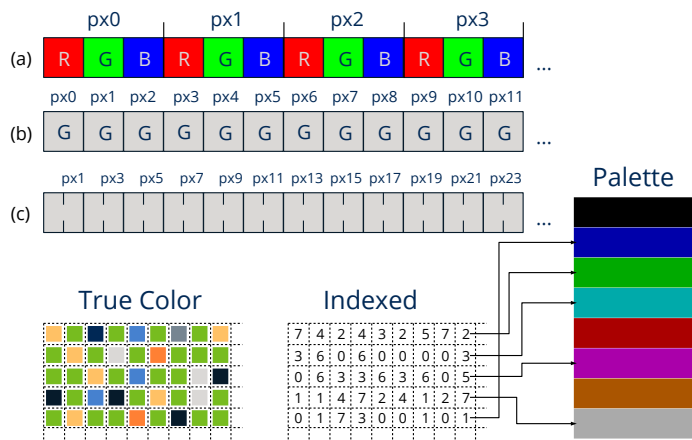

Figure 17.37: (a) True color, (b) shades of gray, (c) indexed.

17.7.2. Procedural images

One way to “fill” buffers is through algorithms that calculate the value of each pixel. A clear example is found in the representation of fractal sets (Figure 17.38), an area of mathematics dedicated to the study of certain dynamic systems. In *“Fractals”* (page 447) you have the complete application.

- Use `pixbuf_data` to get a pointer to the contents of the buffer.
- Use `pixbuf_set` to write the value of a pixel.
- Use `pixbuf_get` to read the value of a pixel.

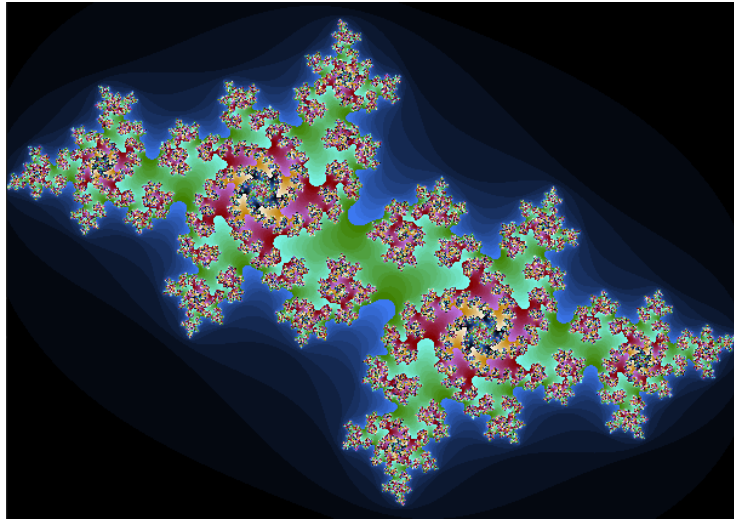

Figure 17.38: Julia set. Pixel-pixel generated image using fractal algorithms.

While `pixbuf_set` and `pixbuf_get` allow safe pixel manipulation, it may sometimes be necessary to get a little extra in terms of performance. In (Listing 17.19) we have some macros for direct access to the memory area returned by `pixbuf_data`. Use them with great care and knowing what you are doing, since they do not have error control methods, so segmentation failures are likely if they are not used correctly.

Listing 17.19: Quick macros for manipulating a buffer type `ekINDEX1` (1 bit per pixel).

```
#define pixbuf_get1(data, x, y, w)\
    (uint32_t)((data[((y)*(w)+(x))/8] >> (byte_t)(((y)*(w)+(x))%8)) & 1)

#define pixbuf_set1(data, x, y, w, v)\
{\
    byte_t *__ob = data + (((y)*(w)+(x))/8);\
    byte_t __op = (byte_t)(((y)*(w)+(x))%8);\
    *__ob &= ~(1 << __op);\
    *__ob |= ((v) << __op);\
}
```

17.7.3. Copy and conversion

During the digital processing of an image, we may have to chain several operations, so it will be useful to be able to make copies of the buffers or format conversions.

- Use `pixbuf_copy` to make a copy.
- Use `pixbuf_convert` to convert to another format (Table 17.4).

Source	Destiny	Observations
RGB24	RGB32	Alpha channel is added with the value 255
RGB32	RGB24	Alpha channel is removed with possible loss of information.
RGB(A)	Gray	RGB channels are weighted at a ratio of 77/255, 148/255, 30/255. Alpha channel is lost.
Gray	RGB(A)	RGB channels (gray, gray, gray) are duplicated. Alpha channel to 255.
RGB(A)	Indexed	The smallest distance between each pixel and the palette is calculated. Possible loss of information.
Indexed	RGB(A)	The palette will be used to obtain each RGBA value.
Indexed	Indexed	If the destination has a lower number of bits, $out = in \% bpp$ will be applied with possible loss of information.
Gray	Indexed	The Gray8 format will be considered indexed for all purposes.
Indexed	Gray	The Gray8 format will be considered indexed for all purposes.

Table 17.4: Conversion between formats.

17.8. Images

There is a close relationship between pixel buffers and images. Although the firsts contain “raw” color information, the latter are objects directly linked to the graphical API of each system, which allows them to be drawn in 2d contexts or viewed in a window (Figure 17.39).

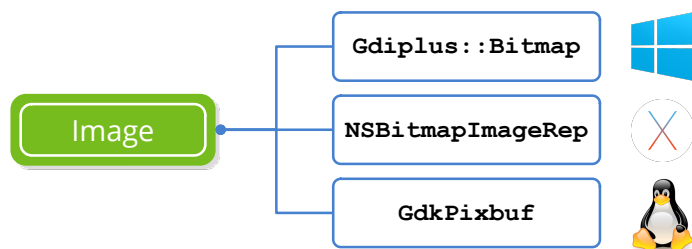

Figure 17.39: Image objects have a direct link to graphics APIs, while Pixbuf do not.

The structure of a digital image, also called *bitmap* or *raster graphics*, is the same as that of a buffer pixel. We have a discrete grid of color dots characterized by its resolution (width, height) and depth, which is the amount of bits needed to encode each pixel (Figure 17.40). *bitmap* images work best for taking snapshots of the real world, where it is practically impossible to describe the scene using geometric primitives, as we saw in “*Drawing primitives*” (page 273). On the other hand, as it is composed of discrete points, it does not behave well in the face of changes in size where it will suffer a loss of quality.



Figure 17.40: On the left an image of 64x64 pixels and 16 colors. Right 256x256 pixels and 16 million colors.

17.8.1. Load and view images

In most cases, the only thing we will need to know about images will be how to read them from disk or other data source and then display them on the screen as part of the user interface (Listing 17.20) (Figure 17.41). We consider that the images are stored in one of the standard formats: JPG, PNG, BMP or GIF.

Listing 17.20: Loading and viewing images.

```
Image *img = image_from_file("lenna.jpg", NULL);
Image *icon = image_from_resource(pack, ekCANCEL);
...
imageview_image(view, img);
button_image(button, icon);
```

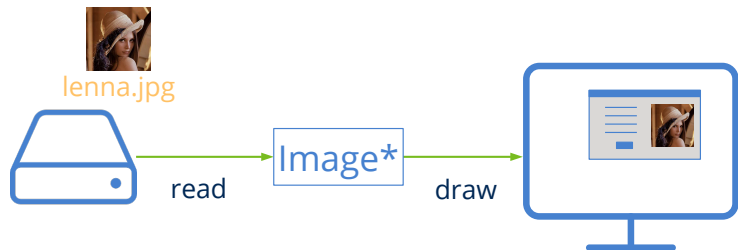

Figure 17.41: Integration of images in the user interface.

- Use `image_from_file` to load an image from disk.
- Use `image_from_data` to create an image from a memory buffer.

- Use `image_from_resource` to get a picture of a resource package.
- Use `image_read` to create an image from “Streams” (page 201).
- In the demo *UrlImg*⁴ you have an example of how to download them from a Web server.

Once the image object is loaded in memory, we have several ways to view it:

- Use `draw_image` to draw an image in a 2d context.
- Use `imageview_image` to assign an image to a view.
- Use `button_image` to assign an image to a button.
- Use `popup_add_elem` to assign a text and icon to a drop-down list.

17.8.2. Generate images

As we saw in “2D Contexts” (page 265), if necessary we can create our own images from drawing commands to later display them in the interface (Figure 17.42) or save them to disk.

- Use `dctx_image` to create an image from a 2d context.

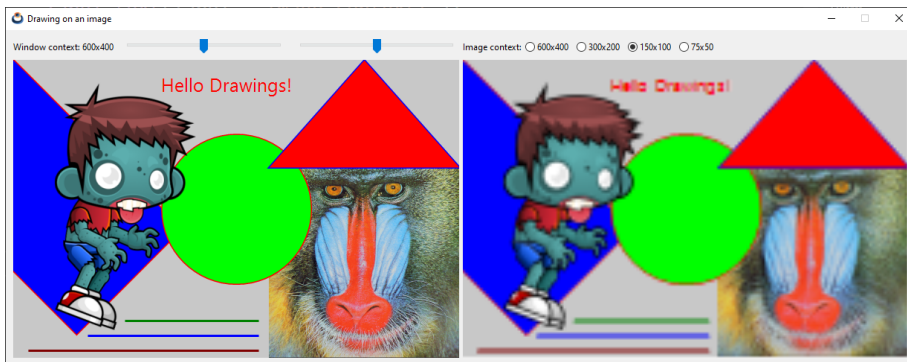

Figure 17.42: Image generated by drawing commands.

17.8.3. Pixel access

Images are **immutable objects** optimized for recurring on-screen drawing, so certain licenses are allowed, both in the internal organization of color information and in the management of possible copies. For this reason it is not possible to directly manipulate the pixels, but we must access them using a “*Pixel Buffer*” (page 288).

- Use `image_from_pixels` to create an image from the color information.

⁴<https://nappgui.com/en/howto/urlimg.html>

- Use `image_from_pixbuf` to create an image from a pixel buffer.
- Use `image_pixels` to get a buffer with the pixels of the image.
- Use `image_width` to get the width.
- Use `image_height` to get the height.
- Use `image_format` to get the pixel format.

Apple technical documentation: “Treat `NSImage` and its image representations as immutable objects. The goal of `NSImage` is to provide an efficient way to display images on the target canvas. Avoid manipulating the data of an image representation directly, especially if there are alternatives to manipulating the data, such as compositing the image and some other content into a new image object.”

The **pixel buffers** allow us to optimally manipulate the content of the image. To view the result or store it in any of the supported formats, we must create a new image (Figure 17.43).

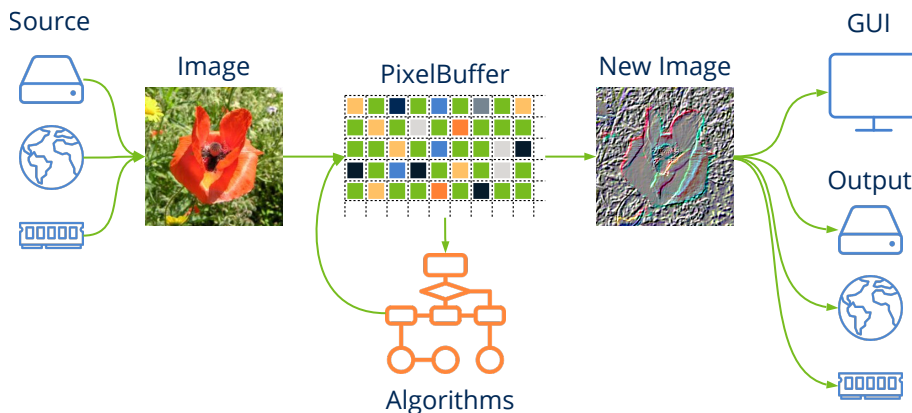

Figure 17.43: Image editing process.

17.8.4. Save images: Codecs

One of the biggest problems of digital images is the large amount of memory they need. An image of only 1024x768 pixels and 32 bits of color needs 3 megabytes of memory. It may not seem like much, but at the end of the 80s this was a great handicap since memory was very expensive and transmissions were very slow. This is why several coding (compression) systems were devised that reduced the amount of memory needed and that were consolidated with the rise of the Internet (Figure 17.44).

- Use `image_get_codec` to get the *codec* associated with the image.

- Use `image_codec` to change the *codec* associated with the image.
- Use `image_to_file` to save it to disk.
- Use `image_write` to write it in a `Stream`.

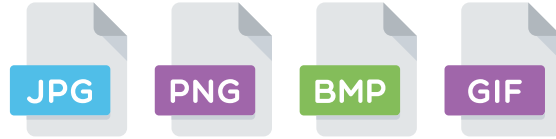

Figure 17.44: Image formats supported by NAppGUI.

Draw2D does not natively support other formats than those mentioned. If necessary, you will have to find a way to create a `Pixbuf` from the specific data of your format, in order to integrate these images into the user interface.

- **JPEG:** *Joint Photographic Experts Group* is a format with a very good compression rate based on the Fourier Transform. Ideal for capturing real-world snapshots, although it will detract some quality from the original capture (lossy compression).
- **PNG:** *Portable Network Graphics* emerged in response to legal problems with the GIF format. Supports lossless LZ77/Deflate compression and indexed pixel formats. Ideal for computer generated diagrams, graphics or images.
- **GIF:** *Graphics Interchange Format* uses the proprietary compression algorithm LZW, although the patent expired in 2003. It has survived PNG because it can include animations in a single file, something that neither of the two previous formats supports.
- **BMP:** *BitMaP*. Windows native format widely surpassed by the other three. Although it supports a special type of compression called *Run-Length encoding*, the truth is that most files are saved uncompressed. BMP files take up much more space, for this reason very little is used on the Internet and almost nothing on non-Windows machines. It is supported by almost all programs and systems because it is very simple and fast to interpret.

To be able to display on the screen, the image must be decompressed (de-encoded), a process that is performed automatically when reading the image. When saving it to disk or sending it over the network, the opposite process is performed, compressed or encoded using the algorithm associated with it (Table 17.5), but it can be changed.

Constructor	Codec
<code>image_from_file</code>	The original codec.
<code>image_from_data</code>	The original codec.

Constructor	Codec
<code>image_from_resource</code>	The original codec.
<code>image_from_pixels</code>	Transparencies? Yes:ekPNG No:ekJPG.
<code>dctx_image</code>	ekPNG.

Table 17.5: Default image codecs.

Generally, GDI+, NSImage or GdkPixbuf support for codec settings is quite limited. For example, it is not possible to generate indexed PNG files, which is very useful when reducing the size of images for the web. If the application requires more control over the export, we will have no choice but to use libpng, libjpeg or any other third-party solution.

17.9. Fonts

Fonts are graphic objects (files) that contain the characters and symbols that we see on a monitor. We remember that a “Unicode” (page 161) string only stores the code of the characters (*codepoints*) without any information about how they will be drawn. The graphic associated with a character is known as a **glyph** and, in a font file, there are as many glyphs as *codepoints* can represent the typography. The pairing between *codepoints* and their corresponding glyphs is carried out by the graphics subsystem of the operating system (Listing 17.21) (Figure 17.45).

Listing 17.21: Drawing of a text string.

```
Font *font = font_create("Comic Sans MS" 28, 0);
draw_font(ctx, font);
draw_text(ctx, "Hello World", 200, 250);
font_destroy(&font);
```

17.9.1. Create fonts

When displaying texts in graphical interfaces it is necessary to establish a typography, otherwise the system would not know how to render it. There will always be a font defined by default, but we can change it when customizing the appearance of our texts.

- Use `font_create` to create a new font.
- Use `font_family` to get the font typeface.
- Use `draw_font` to set the font in 2D contexts.
- Use `label_font` to change the font associated with a `Label` control.

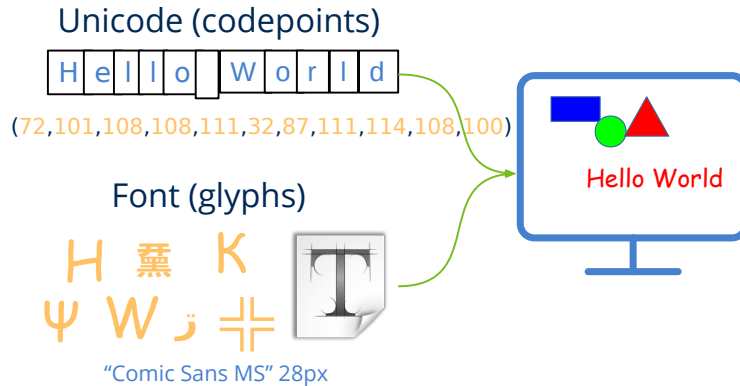

Figure 17.45: Text representation: *codepoints* + glyphs.

The most representative characteristic of a font's design is the family to which it belongs (*font family* or *typeface*) (Figure 17.46). Each computer has a series of families installed that do not have to coincide with those incorporated in another machine. This is an important fact to take into account since, for the sake of portability, we should not assume that a certain font family will be present on all the machines that run the program. Sentences of the type:

```
Font *font = font_create("Comic Sans MS", 28, 0);
```

will not be completely portable, since we are not sure that the *Comic Sans MS* font is installed on all computers.

- Use `font_installed_families` to get the list of all families installed on the machine.

Figure 17.46: Different font families.

17.9.2. System font

- Use `font_system` to create a font with the default family.
- Use `font_regular_size` to get the font size of the interface.

There is always a default font associated with the window environment and that, in a certain way, gives it part of its personality. Using this font guarantees the correct integration of our program in all the systems where it is executed, making our code totally portable (Figure 17.47). Controls such as `Button` or `Label` have the system font associated with a regular size by default. The best known are:

- **Segoe UI:** Windows Vista, 7, 8, 10, 11.
- **Tahoma:** Windows XP.
- **San Francisco:** Mac OSX El Capitan and later.
- **Helvetica Neue:** Mac OSX Yosemite.
- **Lucida Grande:** Mac OSX Mavericks, Mountain Lion, Lion, Snow Leopard.
- **Ubuntu:** Linux Ubuntu.
- **Piboto:** Linux Raspbian.
- **Cantarell:** Kali Linux.

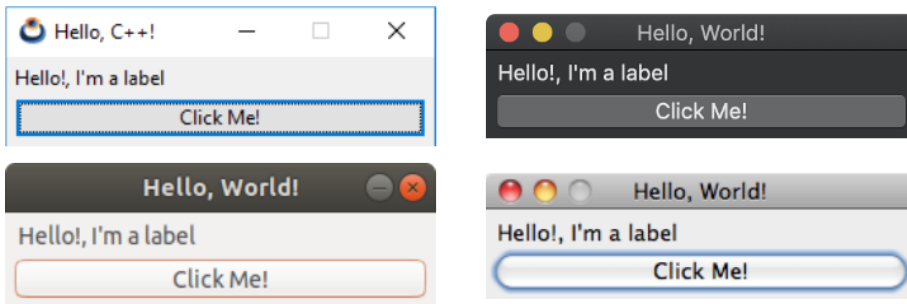

Figure 17.47: Using system font.

17.9.3. Monospace font

In addition to the system font we have another **monospaced** font available by default (Figure 17.48). These fonts imitate old typewriters, where all the characters occupy the same space. They are usually used for technical documents or source code files.

- Use `font_monospace` to create a generic monospace font.
- Use `font_is_monospace` to check if a font is monospace.

- Use `font_installed_monospace` to get all installed monospace fonts.

Figure 17.48: Proportional (variable width) and monospaced (fixed width) font.

The image shows two lines of text. The first line is 'Proportional' in a serif font where the width of each letter varies (e.g., 'P' is wider than 'l'). The second line is 'Monospace' in a monospace font where every letter has the same width, regardless of its shape.

Generally, desktop systems do not offer a monospace font by default. NAppGUI will select the most appropriate one in each case by searching among the installed fonts:

- Windows: **Consolas, Courier New.**
- macOS: **SF Mono, Menlo, Monaco, Andale Mono, Courier New.**
- Linux: **Ubuntu Mono, DejaVu Sans Mono, Courier New.**

Starting with macOS Catalina, a monospace system font is offered.

17.9.4. Font style

- Use `font_style` to get the style.

In addition to the family, we will have certain properties (style) that will also influence its appearance. They are grouped in the `style` parameter of the constructor, combining the values of `fstyle_t` (Figure 17.49).

- `ekFBOLD`. Bold.
- `ekFITALIC`. Italic.
- `ekFUNDERLINE`. Underlined.
- `ekFSTRIKEOUT`. Strikethrough.

The image shows a rectangular box with a blue border containing five lines of text. The first line is 'Hello Normal!' in a standard serif font. The second line is 'Hello Bold!' in a bold serif font. The third line is 'Hello Italic!' in an italicized serif font. The fourth line is 'Hello Underline!' in a serif font with a solid underline. The fifth line is 'Hello Strikeout!' in a serif font with a horizontal line through the middle of the letters.

Figure 17.49: Text style with the same family.

17.9.5. Size and metrics

- Use `font_size` to get the font size.
- Use `font_height` to get the line size.
- Use `font_ascent` to obtain the measurement above the baseline.
- Use `font_descent` to get the measurement below the baseline.
- Use `font_leading` to get the line margin.
- Use `font_extents` to get the size of a text.

Although the font size (**size**) is the only metric that we can configure when creating a font, there are different associated measurements that can be useful when working with vector graphics (Figure 17.50). The most used will be the line height (**height**), in general, somewhat larger than the font size since it includes a small vertical margin (**leading**).



Figure 17.50: Text metrics with a given font.

17.9.6. Size in points

By default, the font size is expressed in pixels, but it can be changed by adding `ekFPOINTS` to the `style` parameter. This unit is related to printed sources on paper. Here the concept of DPI (*dots per inch*) appears, which indicates the number of isolated ink droplets that a printing device can emit per metric inch. In typography the criterion of 72 DPI is established, therefore, the size of a point is approximately 0.35mm. This way it is easy to calculate the font size from the points: 12pt=4.2mm, 36pt=12.7mm or 72pt=25.4mm (1 inch). This is the unit used in **word processors**, which already work based on a print page size. The problem arises when we want to represent fonts expressed in points on a screen, since there is no exact correspondence between pixels and millimeters. The final pixel size depends on the resolution and the physical size of the monitor. A conversion agreement is required between pixels and inches, which gives rise to the term PPI (*pixels per inch*). Traditionally, Windows systems are set at 96 PPI while on Apple iMacs it is 72 PPI. This causes fonts expressed in points to be 33% larger in Windows

(Figure 17.51). Furthermore, in the Microsoft system it is possible to configure the PPI by the user, which adds more uncertainty about the final size of the texts on the screen.

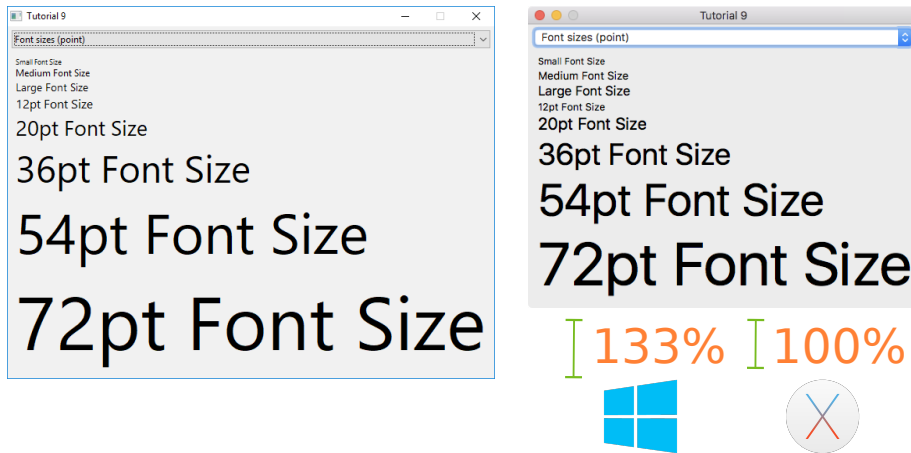

Figure 17.51: The **ekFPOINTS** unit is not recommended for screens.

17.9.7. Bitmap and Outline fonts

In early computers, fonts were created as raster graphics *Bitmap Fonts* (Figure 17.52). Each character fit into a cell of fixed size where those pixels that composed it were marked. The biggest problem is that they don't scale well. As we make the text on the screen larger, the jagged effect of the pixels becomes evident.



Figure 17.52: Bitmap fonts.

In 1982 Adobe launched the PostScript format that included what were known as *Outline Fonts* (Figure 17.53). This format contains a geometric description of each symbol based on lines and Bezier curves. In this way, the pixelated effect of the bitmap is avoided, since when the character is scaled, the pixels that make it up are re-computed in a process known as **rasterization**. At the end of the 80's Apple launched the *TrueType* format and sold a license to Microsoft that incorporated it in Windows 3.1, opening the door to the mass market for vector fonts. Nowadays all systems work with scalable fonts, with

TrueType and *OpenType* being the clearest representatives.

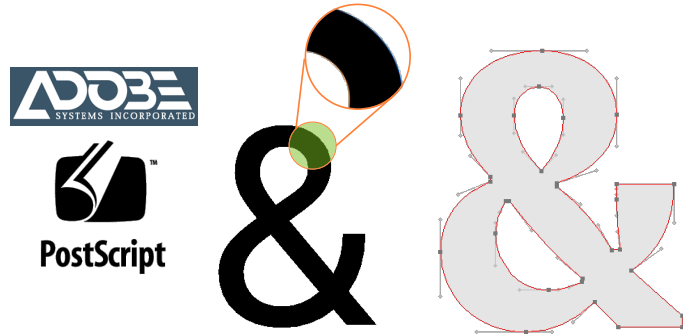

Figure 17.53: Outline fonts, on which the *TrueType* and *OpenType* formats are based.

17.9.8. Unicode and glyphs

Unicode is a very extensive table. In version 11 (June 2018) there are 137,374 *codepoints* registered and this number grows with each new revision of the standard. If the application requires special symbols (above *BMP-Basic Multilingual Plane*) we must make sure that the selected fonts contain glyphs for them. To see the relationship between codepoints and glyphs we can use the BabelMap (Figure 17.54) application, and within it the Font Analysis option. Starting from a Unicode block, it will show those installed fonts that include glyphs for that range. In macOS we have a similar application called *Character Viewer* and in Ubuntu another called *Character Map*.

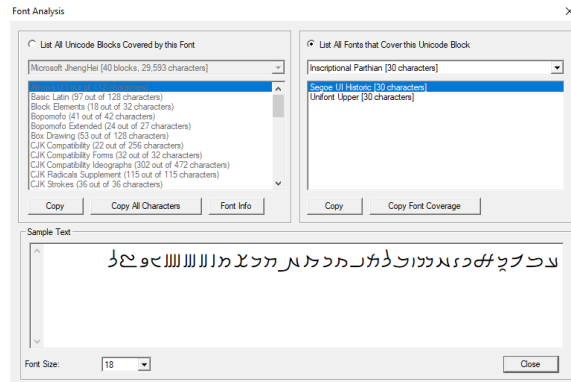

Figure 17.54: BabelMap Font Analysis provides us with information about the glyphs included in each font.

Gui library

18.1	Gui	305
18.1.1	Declarative composition	306
18.1.2	Anatomy of a window.	307
18.1.3	GUI Events	308
18.2	GuiControl	311
18.3	Label	312
18.3.1	Multiline label	313
18.3.2	Label in forms	314
18.3.3	Dynamic labels	314
18.4	Button	316
18.4.1	RadioGroup	317
18.4.2	Button shortcuts	318
18.5	PopUp	319
18.6	Edit	319
18.6.1	Validate texts	319
18.6.2	Filter texts	320
18.6.3	Text selection	322
18.6.4	Clipboard operations	323
18.7	Combo	323
18.8	ListBox	324
18.9	UpDown	324
18.10	Slider	326
18.11	Progress	326
18.12	View	327
18.12.1	Draw in views	328
18.12.2	Scrolling views	328

18.12.3 Drawing overlays	330
18.12.4 Using the mouse	331
18.12.5 Using the keyboard	332
18.13 TextView	332
18.13.1 Character format	333
18.13.2 Paragraph format	334
18.13.3 Document format	335
18.13.4 Apply attributes	335
18.13.5 Text wrapping	335
18.14 WebView	335
18.14.1 WebView dependencies	336
18.14.2 WebView on Windows	337
18.14.3 WebView on macOS	337
18.14.4 WebView on Linux	337
18.14.5 Disable WebView	338
18.15 ImageView	338
18.16 TableView	339
18.16.1 Data connection	339
18.16.2 Data cache	342
18.16.3 Multiple selection	344
18.16.4 Table navigation	344
18.16.5 Configure columns	345
18.16.6 Notifications in tables	345
18.16.7 Table appearance	346
18.17 SplitView	347
18.17.1 Add controls	348
18.17.2 Split modes	349
18.18 Layout	350
18.18.1 Natural sizing	351
18.18.2 Margins and format	352
18.18.3 Alignment	353
18.18.4 Sub-layouts	354
18.18.5 Cell expansion	355
18.18.6 Dynamic interfaces	356
18.18.7 Replacing panels	357
18.18.8 Dynamic layouts	357
18.18.9 Tabstops	359
18.19 Cell	361

18.20 Panel	361
18.20.1 Multi-layout panel	362
18.20.2 Understanding panel sizing	363
18.21 Window	367
18.21.1 Window size	369
18.21.2 Closing the window	369
18.21.3 Modal windows	370
18.21.4 Overlay windows	372
18.21.5 Keyboard focus	373
18.21.6 Focus change	374
18.21.7 Focus protocol	374
18.21.8 Tablist without cycles	375
18.21.9 Default button	375
18.21.10 Keyboard shortcuts	375
18.22 GUI Data binding	377
18.22.1 Basic type binding	377
18.22.2 Limits and ranges	380
18.22.3 Nested structures	381
18.22.4 Notifications and calculated fields	385
18.23 Menu	387
18.24 MenuItem	389
18.25 Common dialogs	389

18.1. Gui

The *Gui* library allows you to create graphical user interfaces in a simple and intuitive way. Only available for desktop applications for obvious reasons (Figure 18.1), unlike the rest of libraries that can also be used in command line applications.

Like “*Draw2D*” (page 264) and “*Osbs*” (page 174) *Gui* relies on the APIs of each operating system. In addition to the advantages already mentioned in these two cases, native access to interface elements will cause our programs to be fully integrated in the desktop and according to the visual theme present in each machine (Figure 18.2).

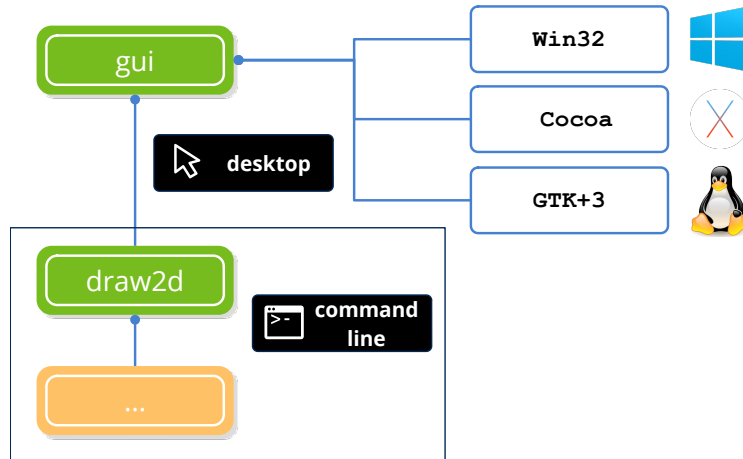

Figure 18.1: Dependencies of *Gui*. See “*NAppGUI API*” (page 151).

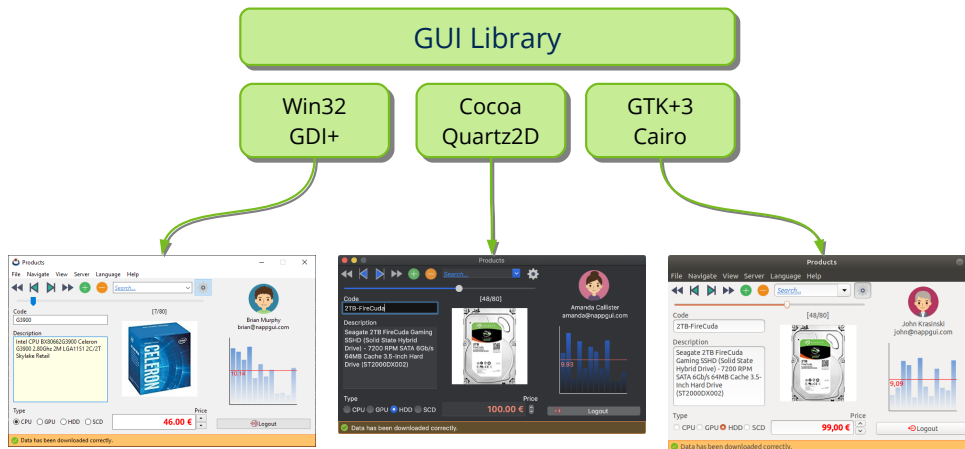

Figure 18.2: The interfaces created with *Gui* will adapt to the style of each window environment.

18.1.1. Declarative composition

The *Gui* library moves away from the concept of treating windows (or dialog boxes) as an external resource of the program. On the contrary, these are created directly from the source code avoiding layout by visual editors (Figure 18.3). We must bear in mind that window managers use different fonts and templates, so specifying specific positions and sizes for the elements will not be portable between platforms (Figure 18.4). On the contrary, in *Gui* the controls are located in a virtual grid called `Layout`, which will calculate its location and final size at runtime and depending on the platform (Figure 18.5).

In addition, another relevant fact is that interfaces are living objects subject to constant

Figure 18.3: Resource editors are not good allies to create complex dynamic interfaces. Even less if we want to carry them between platforms.

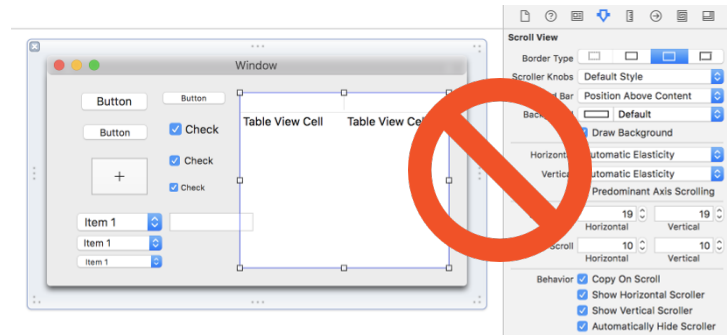

Figure 18.4: Using fixed dimensions for controls will not adapt well when migrating the program.

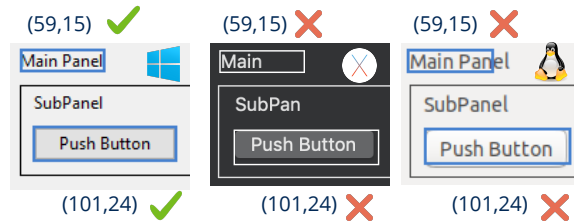
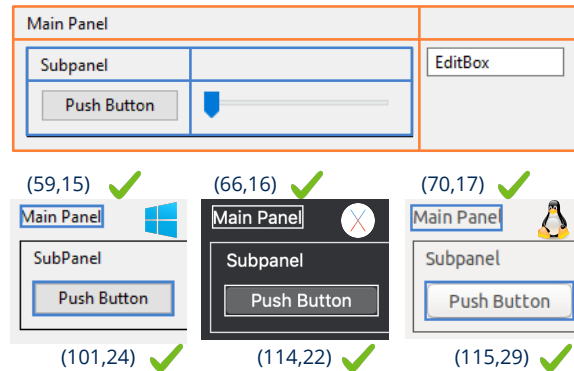

Figure 18.5: The Layout calculates the position and size of the components at runtime.



changes. A clear example is the translations, which alter the location of the elements due to the new dimension of the text (Figure 18.6). *Gui* will adapt to these events automatically, recalculating positions to maintain a consistent layout.

18.1.2. Anatomy of a window.

In (Figure 18.7) we have the main parts of a window. **Controls** are the final elements with which the user interacts to enter data or launch actions. The **views** are rectangular regions of relatively large size where information is represented by text and graphics, being able to respond to keyboard or mouse events. Finally, all these elements will be grouped into **panels** and will be layout by **layouts**.

- “*GuiControl*” (page 311). Different types of controls and views.

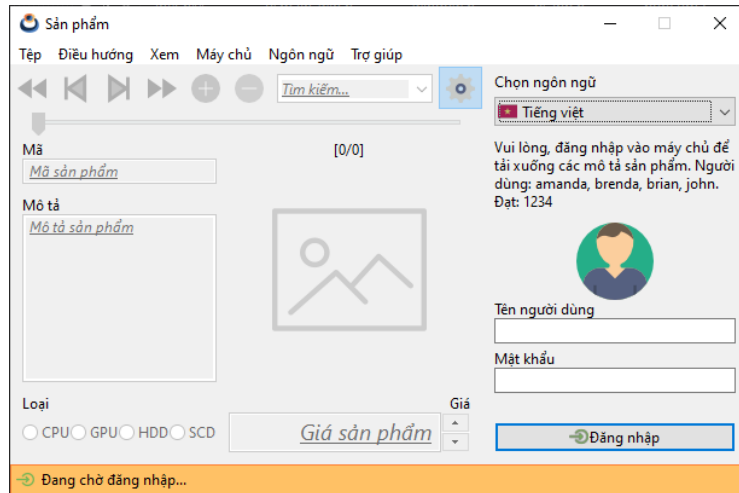

Figure 18.6: The windows automatically adapt to runtime changes.

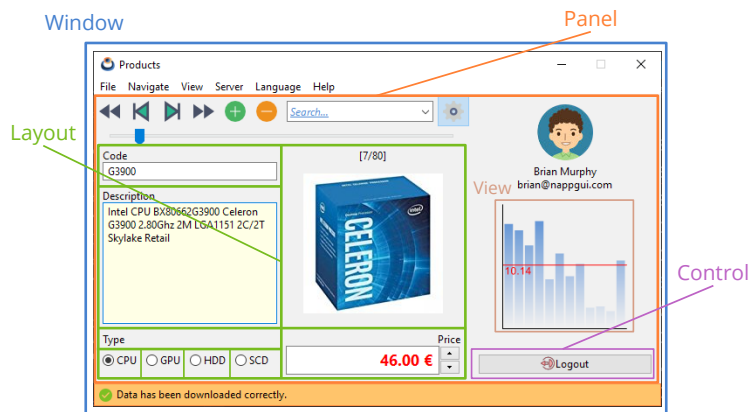

Figure 18.7: Notable parts in an interface window.

- “*Layout*” (page 350). Virtual and invisible grid where the controls will be located.
- “*Window*” (page 367). Main window with title bar and frame.
- “*Menu*” (page 387). Drop-down list with options.
- “*MenuItem*” (page 389). Each of the menu items.

18.1.3. GUI Events

Desktop applications are event driven, which means that they are continually waiting for the user to perform some action on the interface: Press a button, drag a *slider*, write a text, etc. When this occurs, the window manager detects the event and notifies the

application (Figure 18.8), which must provide an **event handler** with the code to execute. For example in (Listing 18.1) we define a handler to respond to the press of a button. Obviously, if there is no associated handler, the application will ignore the event.

- Use `event_params` to obtain the parameters associated with the event. Each type of event has its own parameters. See (Table 18.1).
- Use `event_result` to write the response to the event. Very few events require sending a response.

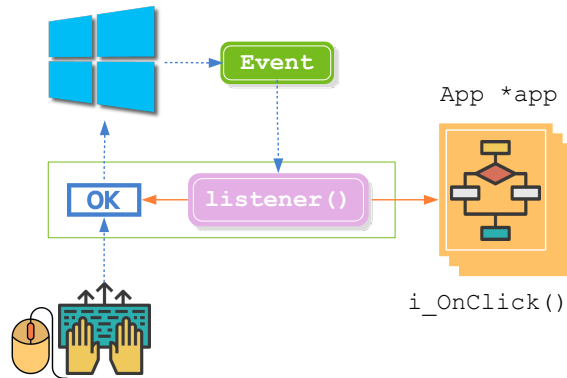

Figure 18.8: Notification of an event through the handler.

Listing 18.1: Assign a handler for the push of a button.

```
static void i_OnClick(App *app, Event *e)
{
    const EvButton *p = event_params(e, EvButton);
    if (p->state == ekGUI_ON)
        create_new_file(app);
}

Button *button = button_check();
button_OnClick(button, listener(app, i_OnClick, App));
```

Sometimes it may be necessary to fire an event while the application is in “standby mode”, without processing any other pending events. This occurs when we want to launch a secondary or modal window as a consequence of another event, for example, the pressing of a button. It is advisable, to avoid blocking or unwanted artifacts, to let the first event conclude and schedule the response for a later time, where the application has no pending tasks.

- Use `gui_OnIdle` to raise an event when there are no other pending tasks.

Listing 18.2: Launching a modal window after clicking a button.

```
static void i_OnIdle(App *app, Event *e)
{
    window_modal(app->modal_window, app->main_window);
}
```

```

}

static void i_OnClick(App *app, Event *e)
{
    // The modal window will be launched after
    // the OnClick event is totally processed.
    gui_OnIdle(listener(app, i_OnIdle, App));
}

```

Event	Handler	Parameters	Response
Click in label	label_OnClick	EvText	-
Click on button	button_OnClick	EvButton	-
Selection in PopUp	popup_OnSelect	EvButton	-
A mouse button was pressed	listbox_OnDown	EvMouse	bool_t
Selection in ListBox	listbox_OnSelect	EvButton	-
Keystroke or paste	edit_OnFilter	EvText	EvTextFilter
End of edit in Edit	edit_OnChange	EvText	bool_t
Edit has received or lost keyboard focus	edit_OnFocus	bool_t	-
Key press on Combo	combo_OnFilter	EvText	EvTextFilter
End of editing in Combo	combo_OnChange	EvText	bool_t
Slider movement	slider_OnMoved	EvSlider	-
Click on UpDown	updown_OnClick	EvButton	-
Draw the contents of a view	view_OnDraw	EvDraw	-
Draw the overlay of a view	view_OnOverlay	EvDraw	-
The size of a view has changed	view_OnSize	EvSize	-
The mouse enters the area of a view	view_OnEnter	EvMouse	-
The mouse leaves the area of a view	view_OnExit	-	-
The mouse moves over a view	view_OnMove	EvMouse	-
A mouse button was pressed	view_OnDown	EvMouse	-
A mouse button has been released	view_OnUp	EvMouse	-
Click on a view	view_OnClick	EvMouse	-

Event	Handler	Parameters	Response
Dragging on a view	<code>view_OnDrag</code>	<code>EvMouse</code>	-
Mouse wheel on a view	<code>view_OnWheel</code>	<code>EvWheel</code>	-
Press key on a view	<code>view_OnKeyDown</code>	<code>EvKey</code>	-
Release key on a view	<code>view_OnKeyUp</code>	<code>EvKey</code>	-
View has received or lost keyboard focus	<code>view_OnFocus</code>	<code>bool_t</code>	-
View resing keyboard focus	<code>view_OnResignFocus</code>	-	<code>bool_t</code>
View accepts keyboard focus	<code>view_OnAcceptFocus</code>	-	<code>bool_t</code>
The scroll bars are being manipulated.	<code>view_OnScroll</code>	<code>EvScroll</code>	<code>real32_t</code>
Keystroke or paste	<code>textview_OnFilter</code>	<code>EvText</code>	<code>EvTextFilter</code>
TextView has received or lost keyboard focus	<code>textview_OnFocus</code>	<code>bool_t</code>	-
WebView has received or lost keyboard focus	<code>webview_OnFocus</code>	<code>bool_t</code>	-
Close a window	<code>window_OnClose</code>	<code>EvWinClose</code>	<code>bool_t</code>
Window moving around the desk	<code>window_OnMoved</code>	<code>EvPos</code>	-
Window is re-dimensioning	<code>window_OnResize</code>	<code>EvSize</code>	-
Click on an item menu	<code>menuitem_OnClick</code>	<code>EvMenu</code>	-
Color change	<code>comwin_color</code>	<code>color_t</code>	-
Inactivity	<code>gui_OnIdle</code>	-	-

Table 18.1: List of all interface events.

18.2. GuiControl

`GuiControl` is the virtual base class where common functionality is defined for all the controls and views that we use to create the user interfaces (Figure 18.9).

- Use `guicontrol_button` and others to do dynamic casting between types.
- Use `guicontrol` to convert derived types.
- “Label” (page 312). Small blocks of descriptive text.

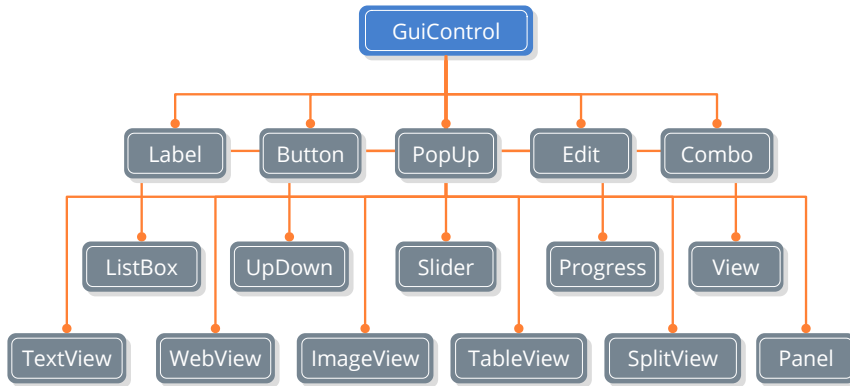

Figure 18.9: Controls and views.

- “*Button*” (page 316). Push buttons, check boxes or radio.
- “*PopUp*” (page 319). Button with drop-down list.
- “*Edit*” (page 319). Text edit box.
- “*Combo*” (page 323). Edit box with drop-down list.
- “*ListBox*” (page 324). List box.
- “*UpDown*” (page 324). Increment and decrement buttons.
- “*Slider*” (page 326). Sliding bar.
- “*Progress*” (page 326). Progress bar.
- “*View*” (page 327). Generic view where you can freely draw.
- “*TextView*” (page 332). View to show and edit texts in multiple formats.
- “*WebView*” (page 335). View to display Web content.
- “*ImageView*” (page 338). View to display images.
- “*TableView*” (page 339). Table view to display information in rows and columns.
- “*SplitView*” (page 347). View divided into two resizable parts.
- “*Panel*” (page 361). Sub-window within the main one with its own controls.

18.3. Label

Label controls are used to insert small blocks of text into windows and forms. They are of uniform format, that is, the font and color attributes will be applied to the entire text. In most cases the content will be limited to a single line, although it is possible to

show blocks that extend in several lines. The control size will be adjusted to the text it contains (Figure 18.10). In “*Hello Label!*” (page 526) you have an example of use.

- Use `label_create` to create a text control.
- Use `label_text` to set the text.
- Use `label_font` to set the font.

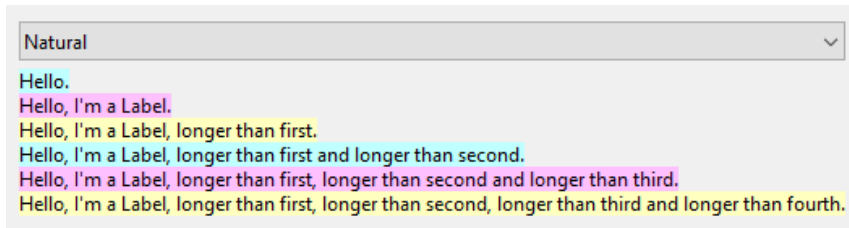

Figure 18.10: Label controls.

18.3.1. Multiline label

- Use `label_multiline` to create a multi-line control.

In the case that the column of `Layout` has a width smaller than the text, some dots (ellipsis) will be displayed at the clipping point (Figure 18.11), except in multi-line labels, which will expand vertically to accommodate all text (Figure 18.12).

Figure 18.11: Text adjustment by reducing the width of the control.

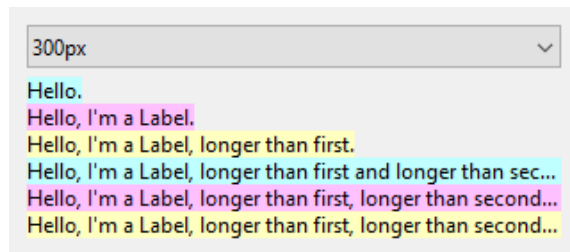
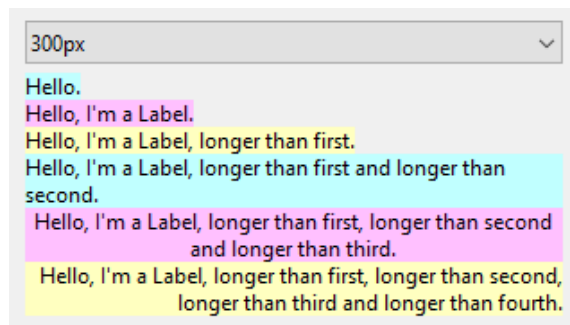

Figure 18.12: Multi-line labels will expand vertically to accommodate all text.



18.3.2. Label in forms

In (Figure 18.13) we have an example of the use of *Label* in forms. If necessary, we can make the texts sensitive to the mouse by varying their style and colors (Figure 18.14).

- Use `label_style_over` to change the font style.
- Use `label_color_over` to change text color.
- Use `label_bgcolor_over` to change background color.
- Use `label_OnClick` to respond to a click on the text.

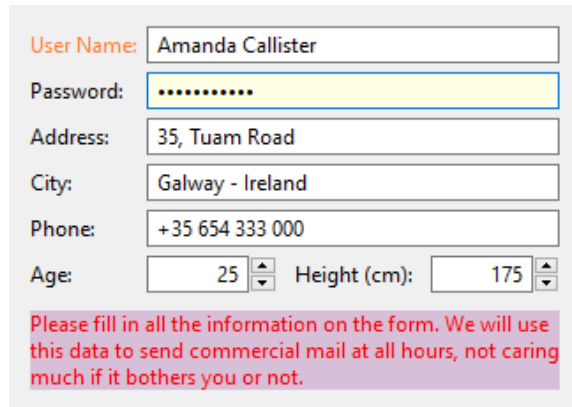

User Name: Amanda Callister

Password:

Address: 35, Tuam Road

City: Galway - Ireland

Phone: +35 654 333 000

Age: 25 Height (cm): 175

Please fill in all the information on the form. We will use this data to send commercial mail at all hours, not caring much if it bothers you or not.

Figure 18.13: Using simple and multiline *Label* in forms.

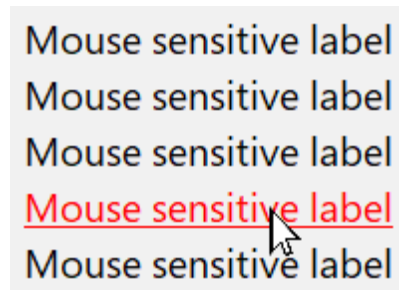

Figure 18.14: *Label* controls sensitive to the mouse.

18.3.3. Dynamic labels

- Use `label_size_text` to set the text to which the control will be sized.
- Use `label_align` to set the internal alignment of the text.

The usual thing will be that the text of a *Label* control is constant, but sometimes we will need to change it to, for example, display status information. In the case of changing the text once the window has been sized, it is possible that the control does not have enough space to accommodate the new text, cutting off and introducing ellipses (Figure 18.15).

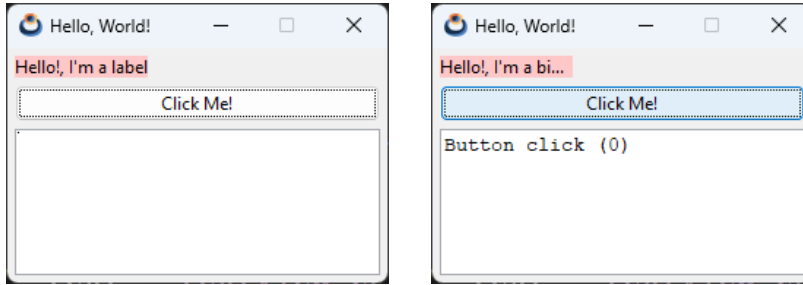

Figure 18.15: Label control does not have enough space to accommodate the new text.

To avoid this, we can set an alt text large enough for all possible values. The label control will use this text to calculate its size (Figure 18.16).

```
label_size_text(label, "Hello, I'm a bigger label");
```

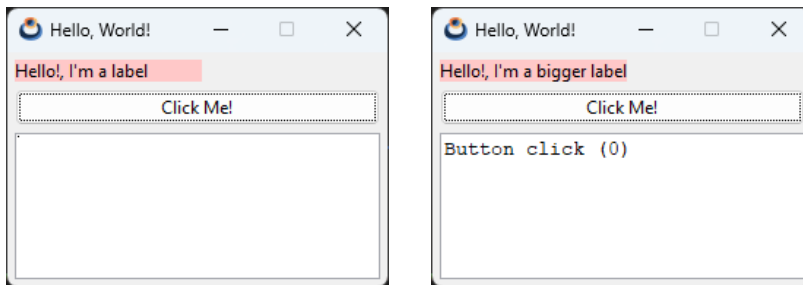

Figure 18.16: Label control properly sized.

Another way to solve this problem is to expand the cell where the Label is housed, with the `ekJUSTIFY` option, occupying the entire width of the layout column (Figure 18.17).

```
// (0, 0) is the cell coords
layout_label(layout, label, 0, 0);
layout_halign(layout, 0, 0, ekJUSTIFY);
```

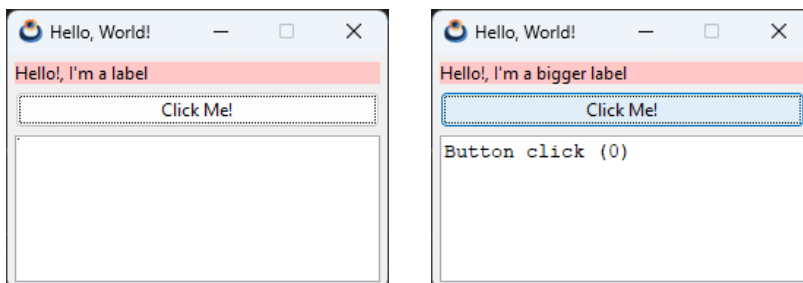

Figure 18.17: Label control expanded to the full width of the column.

In the event that the control is wider than the text itself, we can control the internal alignment with `label_align`.

18.4. Button

The buttons are another classic element in graphic interfaces, where we distinguish four types: the push button, checkbox, radiobutton and flat button typical of toolbars (Figure 18.18) . In “*Hello Button!*” (page 530) you have an example of use.

- Use `button_push` to create a push button.
- Use `button_check` to create a check box.
- Use `button_check3` to create a box with three states.
- Use `button_radio` to create a radio button.
- Use `button_flat` to create a flat button.
- Use `button_flatgle` to create a flat button with status.
- Use `button_text` to assign text.
- Use `button_OnClick` to respond to clic.

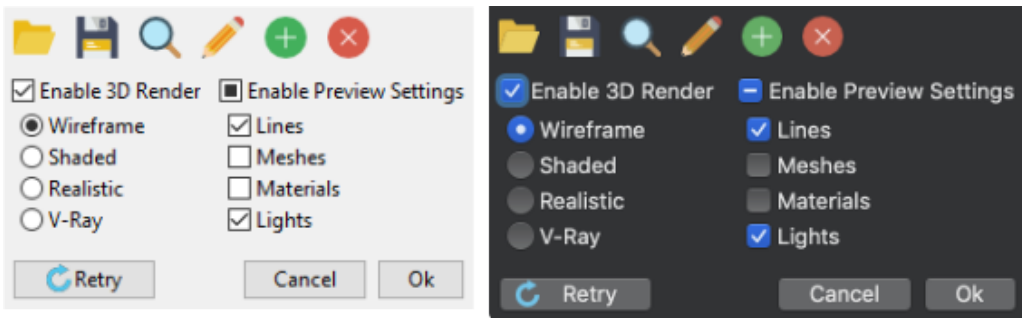

Figure 18.18: Buttons on different platforms.

In addition to capturing the event and notifying the application, the *checkbox* and *flatgle* maintain a state (pressed/check or released/uncheck).

- Use `button_stateto` to set the button status.
- Use `button_get_state` to get the status of the button.

18.4.1. RadioGroup

Special mention is required of the radio buttons, which only make sense when they appear in a group, since they are used to select a single option within a set. Groups are formed at the `Layout` level, that is, all `radiobuttons` of the same layout will be considered from the same group, where only one of them can be selected. If we need several sub-groups, we must create several sub-layout, as shown (Figure 18.19) (Listing 18.3). When capturing the event, the field `indexfrom EvButton` will indicate the index of the button that has been pressed.

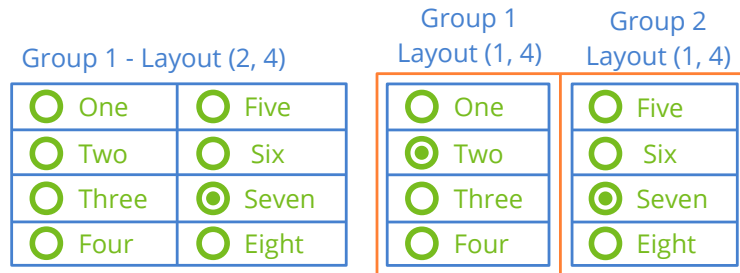

Figure 18.19: Radio groups linked to different layouts.

Listing 18.3: Radio button groups.

```

Button *button1 = button_radio();
Button *button2 = button_radio();
Button *button3 = button_radio();
Button *button4 = button_radio();
Button *button5 = button_radio();
Button *button6 = button_radio();
Button *button7 = button_radio();
Button *button8 = button_radio();
button_text(button1, "One");
button_text(button2, "Two");
button_text(button3, "Three");
button_text(button4, "Four");
button_text(button5, "Five");
button_text(button6, "Six");
button_text(button7, "Seven");
button_text(button8, "Eight");

// One group - One layout
Layout *layout = layout_create(2, 4);
layout_button(layout, button1, 0, 0);
layout_button(layout, button2, 0, 1);
layout_button(layout, button3, 0, 2);
layout_button(layout, button4, 0, 3);
layout_button(layout, button5, 1, 0);
layout_button(layout, button6, 1, 1);
layout_button(layout, button7, 1, 2);

```

```

layout_button(layout, button8, 1, 3);

// Two groups - Two sub-layouts
Layout *layout1 = layout_create(2, 1);
Layout *layout2 = layout_create(1, 4);
Layout *layout3 = layout_create(1, 4);
layout_button(layout2, button1, 0, 0);
layout_button(layout2, button2, 0, 1);
layout_button(layout2, button3, 0, 2);
layout_button(layout2, button4, 0, 3);
layout_button(layout3, button5, 0, 0);
layout_button(layout3, button6, 0, 1);
layout_button(layout3, button7, 0, 2);
layout_button(layout3, button8, 0, 3);
layout_layout(layout, layout1, 0, 0);
layout_layout(layout, layout2, 1, 0);

```

18.4.2. Button shortcuts

It is possible to define a keyboard shortcut equivalent to click the button with the mouse. To do this, when assigning the button text, we will prepend an ampersand ('&') to the character we want to use as a shortcut (Figure 18.20). This character will be underlined and the button will be activated when you press ALT+Char (+Char on macOS). To display the '&' character, instead of using it as a mark, use '&&'.

ALT+D (+D) button shortcut.

```
button_text(button, "Enable 3&D Render");
```

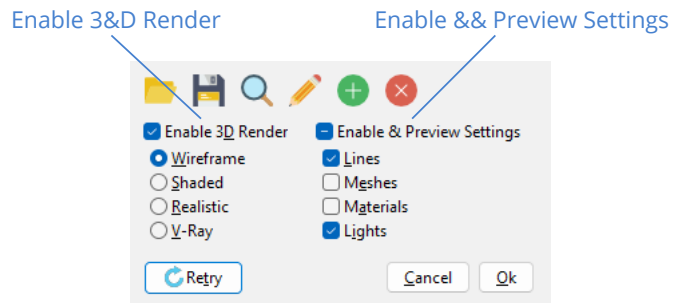

Figure 18.20: Button shortcuts.

In “*Default button*” (page 375) you have more information about the special shortcut related to the [RETURN] key.

In Linux/GTK, the underlining of the shortcuts occurs when you press ALT, unlike Windows/macOS, which are always visible.

18.5. PopUp

PopUps are buttons that have a drop-down menu associated with them (Figure 18.21). Apparently they look like *pushbuttons* that when pressed show a list of options. In “*Hello PopUp and Combo!*” (page 533) you have an example of use.

- Use `popup_create` to create a popup.
- Use `popup_add_elem` to add an item to the list.
- Use `popup_OnSelect` to respond to the selection.



Figure 18.21: PopUps on Windows, macOS and Linux.

18.6. Edit

EditBox are small text boxes with editing capabilities. Like the `Label` they are of uniform format: The typeface and colors will affect the entire text (Figure 18.22). They are usually used to edit fields in forms, normally restricted to a single line, although they can also be extended to several of them. To edit texts with multiple attributes use `TextView`. In “*Hello Edit and UpDown!*” (page 535) you have an example of use.

- Use `edit_create` to create an edit box.
- Use `edit_multiline` to create a multi-line editing box.
- Use `edit_passmode` to hide the text of the control.
- Use `edit_phtext` to set a *placeholder*.

18.6.1. Validate texts

- Use `edit_OnChange` to validate the text.

Depending on the value we are editing, it may be necessary to validate the entered text. Just before losing keyboard focus, the control will receive an `OnChange` event, for which we can provide a specialized handler (Listing 18.6.1) (Figure 18.23). If the text is

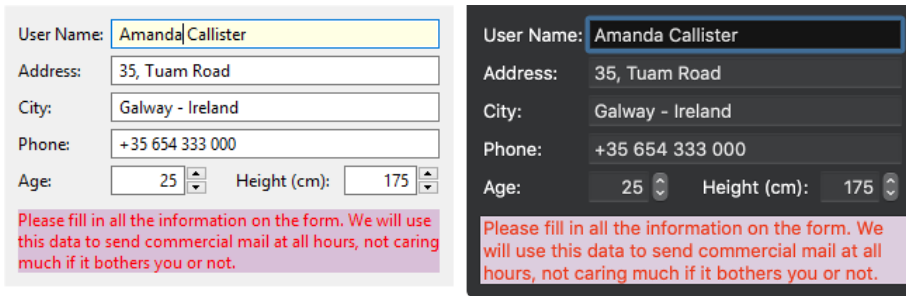

Figure 18.22: Edition boxes on different platforms.

not valid, said handler must return `FALSE`, thus preventing the focus from changing to the next control, remaining in the editbox and forcing the user to correct it.

```
static void i_OnChange(App *app, Event *e)
{
    const EvText *p = event_params(e, EvText);
    if (is_valid_text(data, p->text) == FALSE)
    {
        // Force the focus remain in editbox
        bool_t *r = event_result(e, bool_t);
        *r = FALSE;
    }
}
...
edit_OnChange(edit, listener(NULL, i_OnChange, void));
```

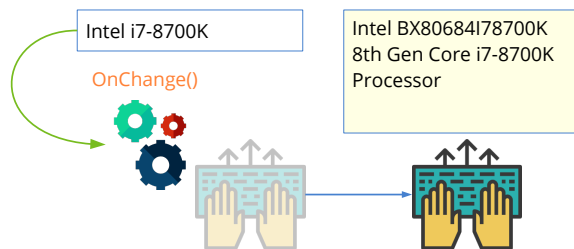

Figure 18.23: The `OnChange` event is called just before the control loses focus.

For example, in “*Hello Edit and UpDown!*” (page 535) activating the *Field validations* check will show a modal window within the `OnChange` event allowing you to validate or reject the text (Figure 18.24).

It will not be possible to move keyboard focus to another control while the text is invalid.

18.6.2. Filter texts

- Use `edit_OnFilter` to detect and correct each user keystroke.

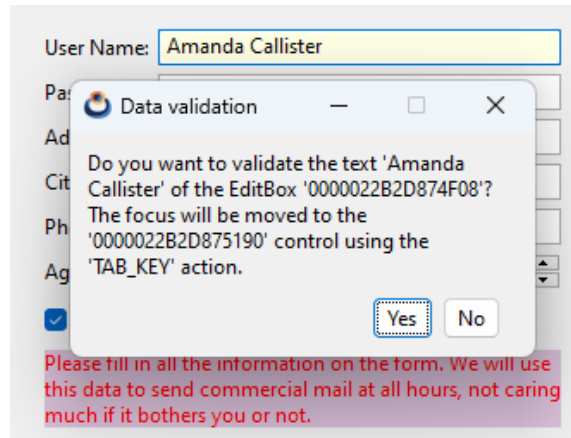

Figure 18.24: Validation of text fields using modal windows.

In case we want to implement more elaborate filters, which correct the text while it is written, we will use the `edit_OnFilter` event (Figure 18.25). We have an example in “*Hello TextSel and Clipboard!*” (page 543). We will receive, through the `EvText` structure, a copy of the current text (`EvText::text`), the position of the cursor (`EvText::cpos`) and the number of characters added or removed (`EvText::len`). From here, if the text must be modified, we must obtain the result structure `EvTextFilter`, setting its `apply` field to `TRUE`. In `EvTextFilter::text` we must copy the new text and, in `EvTextFilter::cpos`, the new position of the cursor. For example, in (Listing 18.4) only the inserted characters are converted to uppercase, leaving the rest of the text intact.

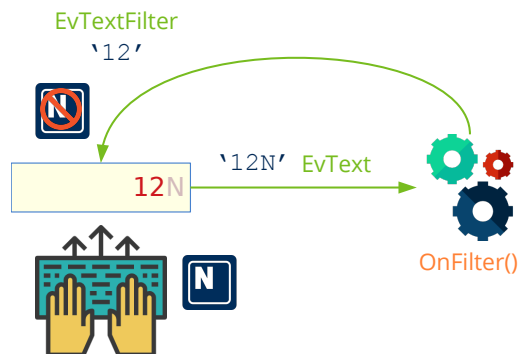

Figure 18.25: The `OnFilter` event is called after each key or paste.

Listing 18.4: Filter that transforms the inserted characters into uppercase letters.

```
static void i_OnFilter(SelData *data, Event *e)
{
    const EvText *p = event_params(e, EvText);
    cassert_no_null(data);

    /*
     * Convert the inserted text in caps.
     * p->text the control current text (const).
    */
}
```

```

* r->text the new filtered text.
* p->cpos current caret position.
* r->apply = TRUE means the editbox text has to be updated.
* p->len number of chars inserted at left of caret (to caps).
* We are working with UTF8-Strings. Sequential access.
*/
if (button_get_state(data->caps) == ekGUI_ON && p->len > 0)
{
    EvTextFilter *r = event_result(e, EvTextFilter);
    const char_t *src = p->text;
    char_t *dest = r->text;
    uint32_t cp = unicode_to_u32(src, ekUTF8);
    uint32_t pos = 0;
    while (cp != 0)
    {
        uint32_t offset = 0;
        if (pos >= p->cpos - p->len && pos < p->cpos)
        {
            if (cp >= 'a' && cp <= 'z')
                cp -= 32;
        }
        offset = unicode_to_char(cp, dest, ekUTF8);
        dest += offset;
        src = unicode_next(src, ekUTF8);
        cp = unicode_to_u32(src, ekUTF8);
        pos += 1;
    }

    *dest = 0;
    r->cpos = p->cpos;
    r->apply = TRUE;
}

textview_printf(data->info_text, "Edit: Pos %d Len %d\n", p->cpos, p->len);
textview_scroll_caret(data->info_text);
}
...
edit_OnFilter(edit, listener(NULL, i_OnFilter, void));

```

18.6.3. Text selection

- Use `edit_select` to select text.
- Use `edit_autoselect` to automatically select all text whenever the control receives keyboard focus.

It is possible through code to change the text selection (Figure 18.26) and the position of the cursor (caret), using this logic.

- If `start == -1` and `end == 0`, all text is deselected, leaving the caret in its current

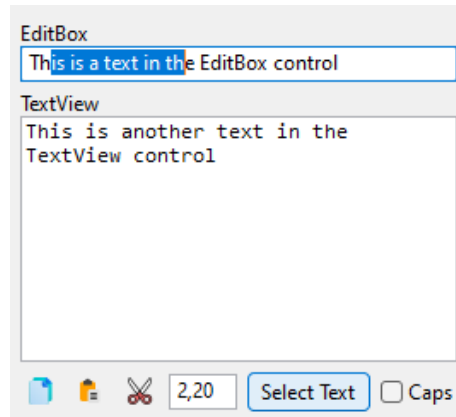

Figure 18.26: Text selection (2, 20).

position.

- If `start == -1` and `end == -1`, all text is deselected, moving the caret to the end of the text.
- If `start == 0` and `end == -1` all the text is selected, moving the caret to the end of the text.
- If `start > 0` and `end == -1` is selected until the end, moving the caret to the end of the text.
- If `start == end` the caret is moved to the position, deselecting all text.

18.6.4. Clipboard operations

As they are native components, the `Edit` controls support typical clipboard operations: Copy, Paste, Cut, etc., as well as their keyboard shortcuts. However, it can be useful to access these operations from the program code, allowing, for example, the text selected in the control to be copied to the clipboard.

- Use `edit_copy` to copy the selected text to the clipboard.
- Use `edit_cut` to cut the selected text, copying it to the clipboard.
- Use `edit_paste` to paste the clipboard text at the caret position.

18.7. Combo

ComboBox are text editing boxes with drop-down list (Figure 18.27). Therefore, they will work in the same way as `Edit` controls on which methods for the management of the list are added. In *“Hello PopUp and Combo!”* (page 533) you have an example of use.

- Use `combo_create` to create a combo.

- Use `combo_text` to set edit text.
- Use `combo_color` to set the text color.
- Use `combo_bgcolor` to set the background color.
- Use `combo_add_elem` to add an item to the list.

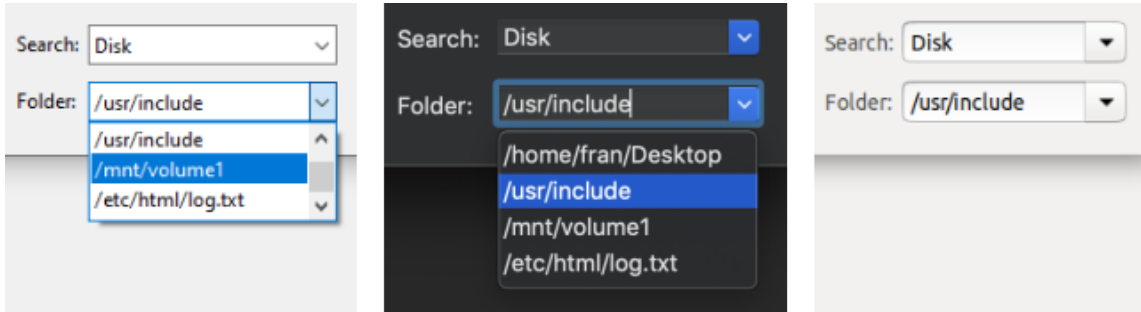

Figure 18.27: Combos on Windows, macOS and Linux.

18.8. ListBox

The **ListBox** are controls that display a series of elements as a list (Figure 18.28), (Figure 18.29), (Figure 18.30). Depending on how it is configured, we can select one or more elements or view *checkboxes* to check them. The control enables scroll bars when necessary and allows keyboard navigation. In “*Hello ListBox!*” (page 556) you have an example of use.

- Use `listbox_create` to create a list control.
- Use `listbox_add_elem` to add an element.
- Use `listbox_multisel` to enable the multiple selection.
- Use `listbox_checkbox` to enable the checkboxes.
- Use `listbox_OnSelect` to respond to the selection.

18.9. UpDown

UpDown are two-part horizontally divided button controls (Figure 18.31). Each part has a small arrow printed and is normally used to make discrete increases in numerical values associated with controls `Edit`.

- Use `updown_create` to create an updown button.
- Use `updown_OnClick` to respond to keystrokes.

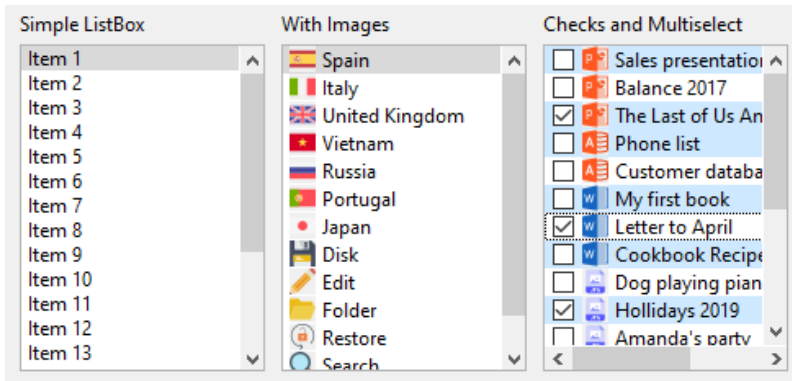

Figure 18.28: ListBox controls in Windows.

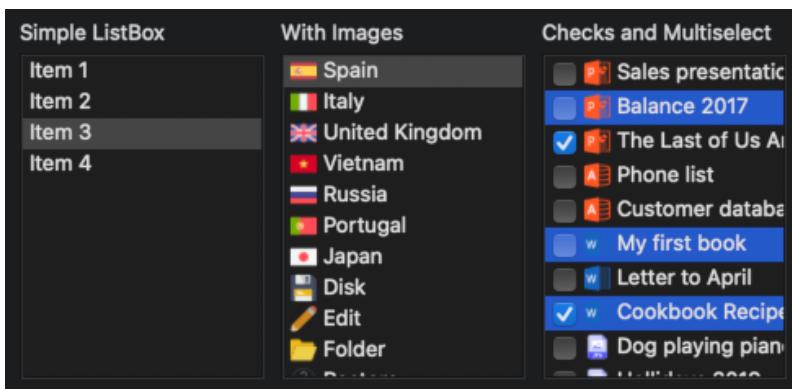

Figure 18.29: ListBox controls in macOS.

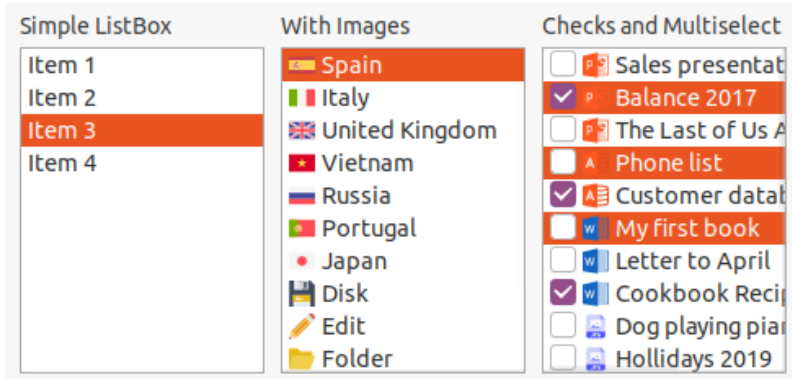

Figure 18.30: ListBox controls in Linux.

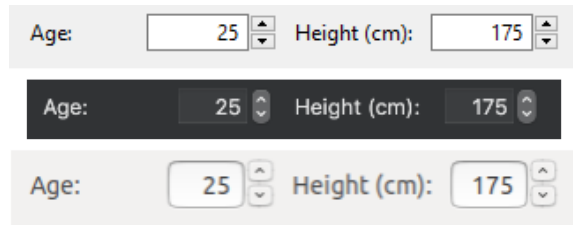

Figure 18.31: UpDown on Windows, macOS and Linux.

18.10. Slider

Sliders are normally used to edit continuous and bounded numerical values (Figure 18.32). As the control moves, *OnMoved* events occur that return a value between 0 and 1. In “*Hello Slider and Progress!*” (page 559) you have an example of use.

- Use `slider_create` to create a horizontal slider.
- Use `slider_vertical` to create a vertical slider.
- Use `slider_OnMoved` to respond to scrolling.

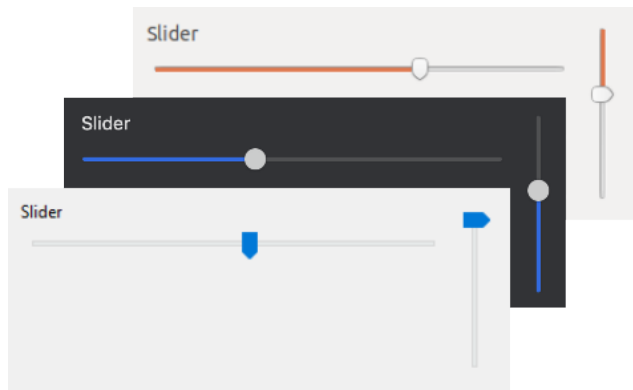

Figure 18.32: Sliders on Windows, macOS and Linux.

18.11. Progress

Progress bars are passive controls that show the remaining time to complete a certain task (Figure 18.33). As time passes we must update the control. The undefined state will show an animation without indicating status, which will be useful when we cannot determine the required time.

- Use `progress_create` to create a progress bar.
- Use `progress_undefined` to set the bar as undefined.
- Use `progress_value` to update the progress of the task.

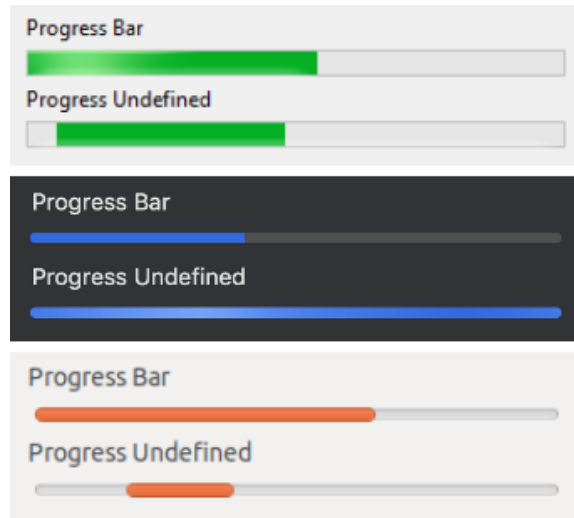

Figure 18.33: ProgressBar on Windows, macOS and Linux.

18.12. View

The **View** controls or custom views (Figure 18.34) are blank areas within the window that allow us to implement our own components. We will have total freedom to draw and capture the mouse or keyboard events that allow us to interact with it.

- Use `view_create` to create a view.
- Use `view_data` to set a data object.
- Use `view_get_data` to get this object.
- Use `view_size` to set the default size. See “*Natural sizing*” (page 351).

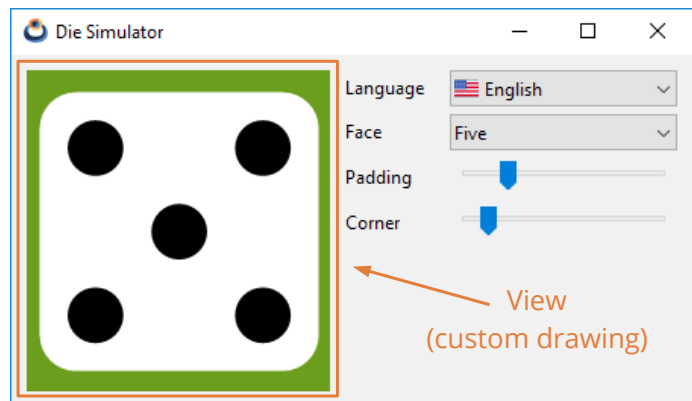

Figure 18.34: Custom view control.

18.12.1. Draw in views

The contents of the drawing area will need to be refreshed on certain occasions. Either because the operating system must update a previously overlapping part, or because the drawing itself has changed (animations, user actions, etc.). When the time comes, the window manager will launch an `OnDraw` event that the application must capture to implement the drawing commands that allow the content to be recreated.

- Use `view_OnDraw` to set the drawing handler.
- Use `view_update` to force an area update.

The `OnDraw` event handler will receive a drawing context, on which the different “*Drawing primitives*” (page 273) (Listing 18.5) can be applied.

Listing 18.5: Basic drawing in custom views.

```
static void i_OnDraw(App *app, Event *e)
{
    const EvDraw *p = event_params(e, EvDraw);
    draw_clear(p->ctx, kCOLOR_RED);
    draw_line_width(p->ctx, 10.f);
    draw_line_color(p->ctx, kCOLOR_GREEN);
    draw_rect(p->ctx, ekSTROKE, 0, 0, p->width, p->height);
}
...
view_OnDraw(view, listener(app, i_OnDraw, App));
```

In “*Die*” (page 423) you have a simple example application that implements drawing custom views. It represents the figure of a die, allowing us to edit certain parameters of the drawing. This interaction will launch a series of events that will require the redrawing of our figure. The entire cycle can be summarized in these steps (Figure 18.35):

- Some event occurs that requires updating the content of the view.
- The application calls the `view_update` method to notify that the view must be updated.
- At the appropriate moment, the system will send an `OnDraw` event with a `Dctx` context ready to draw.

The operating system can launch `OnDraw` events at any time without previously calling `view_update`.

18.12.2. Scrolling views

It is possible that the “scene” to be rendered is much larger than the control itself, so it will show only a small fragment of it (Figure 18.36). In these cases we will say that the

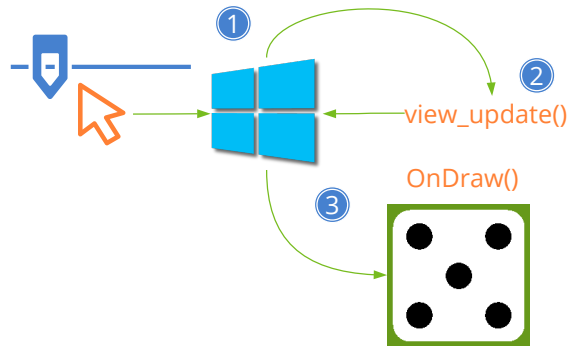

Figure 18.35: Refresh cycle of a custom view.

view is a *viewport* of the scene. We can manage it in two ways:

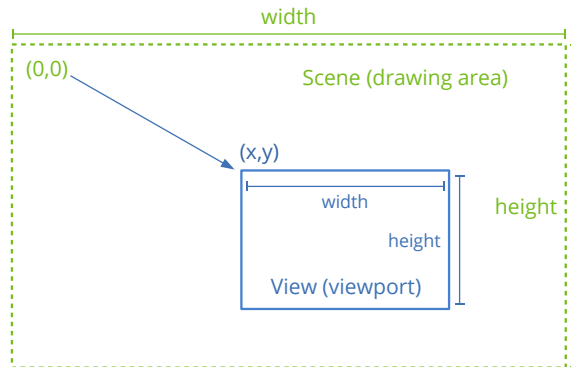

Figure 18.36: Scene and view (viewport).

- Use `draw_matrixf` at the beginning of `OnDraw` to indicate the transformation that integrates the displacement, zoom and possible rotation of the viewport with respect to the scene. All of this must be managed by the application and we do not have to do anything special, except call `view_update` every time it is necessary to refresh.
- Use scroll bars that allow the user to move freely through the content. In this case, managing the view is a bit more complicated. This is what we must take into account:
 - Use `view_scroll` or `view_custom` to create the view.
 - Use `view_content_size` to indicate the measurements of the scene, so that the bars are sized correctly.
 - Use `view_scroll_x`, `view_scroll_y` if we want to move the scroll bars from the code.
 - Use `view_viewport` to get the position and dimensions of the visible area.
 - Use `view_OnScroll` to detect when the user manipulates the scroll bars.

Something important to keep in mind is to avoid drawing non-visible elements, especially in very large scenes or with a multitude of objects. The operating system will send

successive `OnDraw()` events as the user manipulates the scrollbars, indicating the *viewport* parameters in the `EvDraw` structure. In “*DrawBig*” (page 731) you have an example application that shows how to correctly manage this type of cases.

It is possible that the dimensions of the viewport received in `OnDraw` are somewhat larger than the size of the control. This is because certain window managers force you to draw in certain non-visible areas close to the edges, in order to avoid flickering when scrolling very quickly.

18.12.3. Drawing overlays

- Use `view_OnOverlay` to draw overlays.

An overlay is a graphic layer that is drawn on top of the main content dumped by the `OnDraw` event. It uses the coordinate system of the `View` control where the coordinate (0,0) corresponds to the top-left border (Figure 18.37) (Listing 18.6). Therefore, the overlays remain fixed, regardless of the movement of the scroll bars. They are useful for drawing markers or information that we do not want to be displaced. They can also be used in views without scroll bars.



Figure 18.37: Overlay drawing. Animation at <https://nappgui.com/img/gui/overlay.gif>.

Listing 18.6: Code to generate the overlay.

```
static void i_OnOverlay(App *app, Event *e)
{
    const EvDraw *p = event_params(e, EvDraw);
    cassert_no_null(app);
    if (app->overlay == TRUE)
    {
        draw_fill_color(p->ctx, kCOLOR_BLACK);
        draw_text_color(p->ctx, kCOLOR_WHITE);
        draw_rect(p->ctx, ekFILL, 5, 5, 80, 20);
        draw_text(p->ctx, "OVERLAY", 5, 5);
    }
}
...

```

```
view_Overlay(view, listener(app, i_Overlay, App));
```

18.12.4. Using the mouse

In order to interact with the control, it is necessary to define handlers for the different mouse events (Listing 18.7), (Figure 18.38). The operating system will notify the user's actions so that the application can launch the relevant actions. It is not necessary to use all of them, only the essential ones in each case.

Listing 18.7: Response to mouse events.

```
static void i_OnMove(App *app, Event *e)
{
    const EvMouse *p = event_params(e, Event);
    do_something_onmouse_moved(app, p->x, p->y);
}
...
view_OnMove(view, listener(app, i_OnMove, App));
```

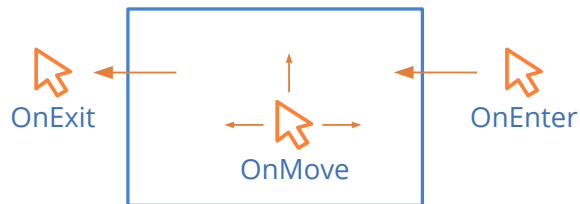

Figure 18.38: View position events.

- Use `view_OnEnter` to know when the cursor enters the view.
- Use `view_OnExit` to know when the cursor leaves the view.
- Use `view_OnMove` to know when the cursor is moving through the view.
- Use `view_OnDown` to know when a button is pressed within the view.
- Use `view_OnUp` to know when a button is released inside the view.
- Use `view_OnClick` to identify a click (Fast Up + Down).
- Use `view_OnDrag` to move the cursor with a pressed button.
- Use `view_OnWheel` to use the mouse wheel.

If the view uses scroll bars, the cursor (x,y) position passed to `EvMouse` in each event, refers to the global coordinates of the scene, taking into account the displacement. In views without scroll bars, they are the control local coordinates. The local coordinates of the viewport are in (lx,ly) .

18.12.5. Using the keyboard

When a view receives “*Keyboard focus*” (page 373), all keystrokes will be directed to it, so we must implement the appropriate handlers.

- Use `view_OnKeyDown` to detect when a key is pressed.
- Uses `view_OnKeyUp` to detect when a key is released.
- Use `view_OnFocus` to notify the application whenever the view receives (or loses) keyboard focus. In (Figure 18.39), the view changes the color of the active cell when it has focus.
- Use `view_OnResignFocus` to prevent the view from losing keyboard focus.
- Use `view_OnAcceptFocus` to prevent the view from getting keyboard focus.

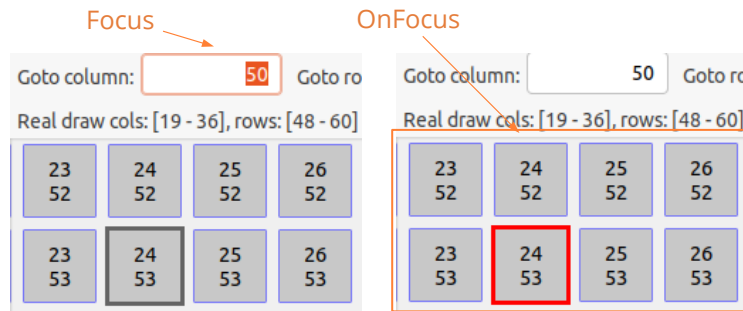

Figure 18.39: View without keyboard focus (left) and with it (right).

If a view does not need to use the keyboard, make sure it cannot receive focus when you press [TAB] “Tabstops” (page 359). It also implements `view_OnAcceptFocus` to prevent it from getting focus when you click on it.

In the `KeyDown` and `KeyUp` events a `vkey_t` will be received with the value of the pressed key. In (Figure 18.40) and (Figure 18.41) the correspondence of these codes is shown. In “*Synchronous applications*” (page 397) we may need to know if a key is pressed or not during the update cycle (synchronous) where we do not have access to the `OnKeyDown` and `OnKeyUp` events (asynchronous). This can be done by assigning the view a keyboard buffer using `view_keybuf`, which will capture the events associated with each key and allow us to consult its status at any time in a comfortable way.

18.13. TextView

TextView are views designed to work with rich text blocks (Figure 18.42), where fonts, sizes and colors can be combined. We can consider them as the basis of a text editor. In

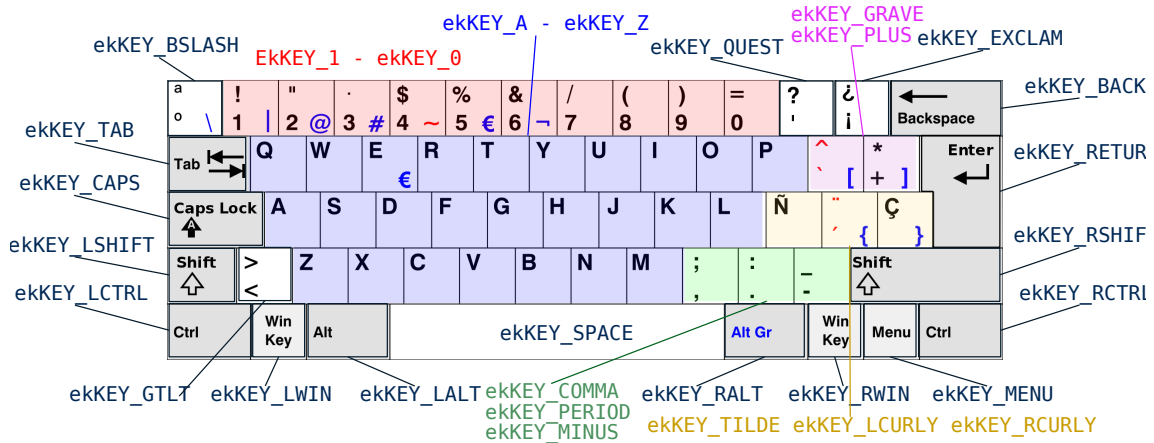

Figure 18.40: Keyboard codes.

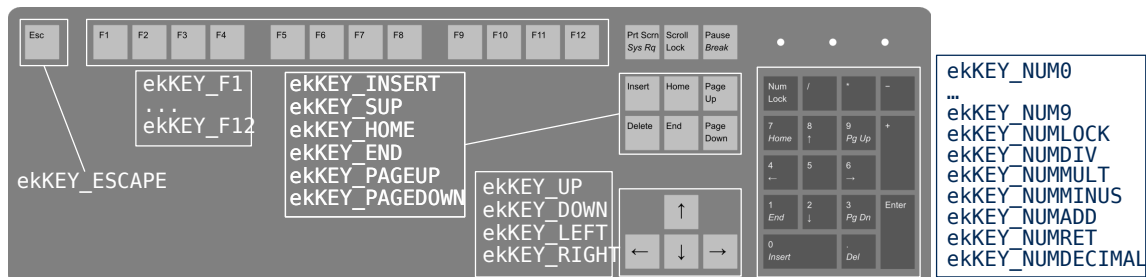

Figure 18.41: Keyboard Extended Codes.

“Hello TextView!” (page 560) you have an example of use.

- Use `textView_create` to create a text view.
- Use `textView_writef` to insert text.
- Use `textView_printf` to insert text in the format of `printf`.
- Use `textView_select` to position the caret.
- Use `textView_clear` to erase all text.

18.13.1. Character format

One of the advantages of rich text over plain text is the ability to combine different character formats within the same paragraph (Figure 18.43). Changes will be applied to new text added to the control.

Use `textView_family` to set the font.

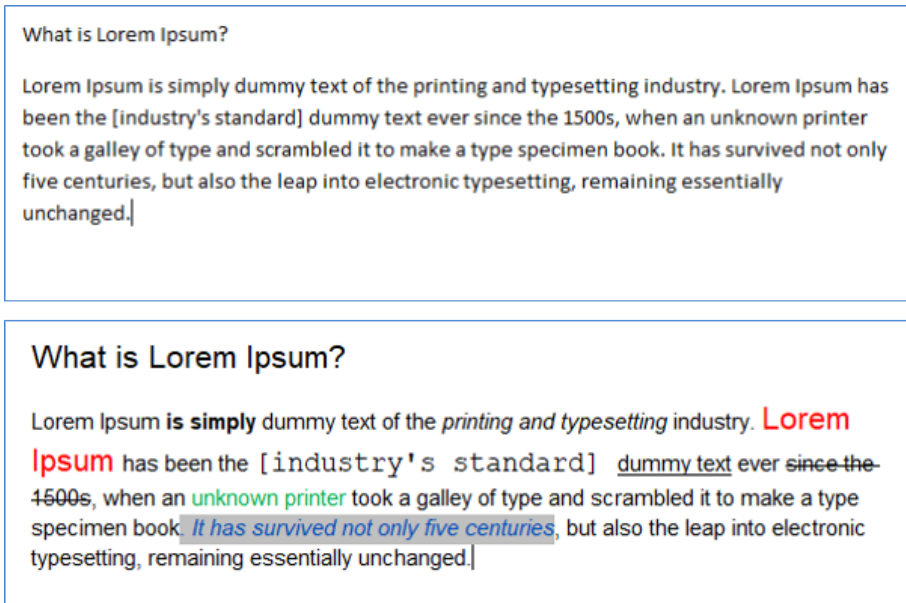

Figure 18.42: Plain text and rich text.

Use `textview_fsize` to set the character size.

Use `textview_fstyle` to set the style.

Use `textview_color` to set the text color.

Use `textview_bgcolor` to set the background color of the text.

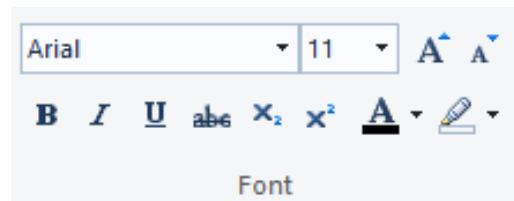

Figure 18.43: Typical Character Format Controls.

18.13.2. Paragraph format

You can also set attributes per paragraph (Figure 18.44). The new line character '`\n`' is considered the closing or end of the paragraph.

Use `textview_halign` to set to paragraph alignment.

Use `textview_lspacing` to set line spacing (line spacing).

Use `textview_bfspace` to indicate the vertical space before the paragraph.

Use `textview_afspace` to indicate the vertical space after the paragraph.



Figure 18.44: Typical controls for paragraph formatting.

18.13.3. Document format

Finally we have several attributes that affect the entire document or control.

Use `textview_units` to set the text units.

Use `textview_pgcolor` to set the background color of the control (page).

18.13.4. Apply attributes

The text attributes seen in the previous sections will be applied to new text added to the control using the `textview_writeln` or `textview_printf` functions. However, we can apply them to text already existing in the control. In “*Hello TextEditor!*” (page 549) you have an example of use.

- Use `textview_apply_all` to apply the attributes to all the text in the control.
- Use `textview_apply_sel` to apply the attributes to the selected text.

18.13.5. Text wrapping

- Use `textview_wrap` to turn text wrapping on/off.

By default, the control automatically adjusts the width of the text, cutting lines when necessary. This can be avoided by passing `wrap=FALSE`, where each line will occupy its natural width and a horizontal scroll bar will appear to scroll the text (Figure 18.45).

18.14. WebView

A **WebView** control will allow us to embed Web content in our application. It will behave in the same way as other view controls such as `View` or `TextView` in terms of layout or resizing, displaying a fully functional browser in its client area (Figure 18.46). In “*Hello WebView!*” (page 641) you have an example application.

- Use `webview_create` to create a webview.

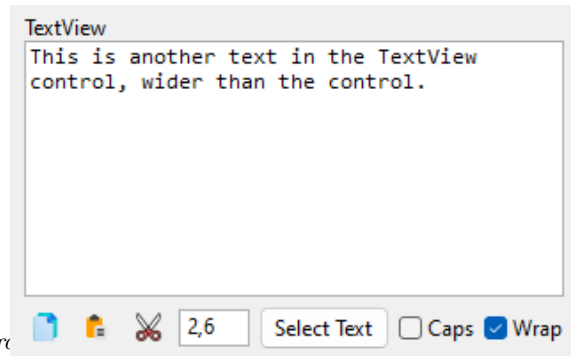

Figure 18.45: Text wrapping. Animation in https://nappgui.com/img/gui/textview_wr

- Use `webview_navigate` to display the content of a URL.
- Use `webview_back` to go to the previous page.
- Use `webview_forward` to go to the next page.



Figure 18.46: Application that integrates a WebView.

18.14.1. WebView dependencies

WebView depends on native technologies in each operating system: **Edge:WebView2** on Windows, **WebKit2** on GTK/Linux and **WKWebView** on macOS (Figure 18.47). The NAppGUI build system will be in charge of managing the dependencies for us automatically. However, you must take these points into account before using this control in your applications successfully.

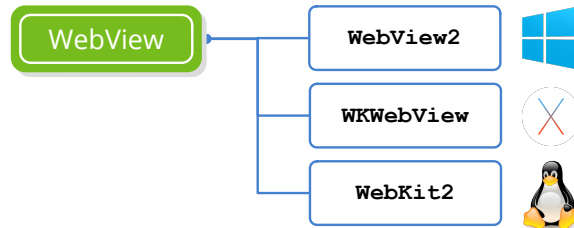

Figure 18.47: Native WebView dependencies.

18.14.2. WebView on Windows

- In the `prj/depend/web/win` folder are the **WebView2** headers and static libraries.
- They have been obtained from this NuGet package¹.
- There are problems when compiling in Debug mode from VS2017 and VS2015. However, in Release mode, applications work without problem using these versions of Visual Studio. More information here².
- Visual Studio 2013 and earlier do not support compilation of **WebView2**.
- MinGW does not support the compilation of **WebView2**.
- It is recommended to use VS2019 or VS2022 to generate applications with **WebView2**.
- **WebView2** only works on Windows 10 and Windows 11.

18.14.3. WebView on macOS

You don't have to do anything special to compile the WebView on macOS. CMake will automatically link to `WebKit.framework`. At the moment, this support is available for macOS **10.10 Yosemite** and later, as `WKWebView` is not present in previous distributions.

18.14.4. WebView on Linux

We will need to install the WebKit2 development libraries on our system so that CMake can enable Web support in NAppGUI.

Installing WebKit2 on Ubuntu.

```

sudo apt-get install libwebkit2gtk-4.1-dev // Ubuntu 24
sudo apt-get install libwebkit2gtk-4.1-dev // Ubuntu 22
sudo apt-get install libwebkit2gtk-4.0-dev // Ubuntu 20
sudo apt-get install libwebkit2gtk-4.0-dev // Ubuntu 18
sudo apt-get install libwebkit2gtk-4.0-dev // Ubuntu 16
sudo apt-get install libwebkit2gtk-3.0-dev // Ubuntu 14
  
```

¹<https://www.nuget.org/packages/Microsoft.Web.WebView2>

²<https://github.com/MicrosoftEdge/WebView2Feedback/issues/2614>

WebKit2 support is not available on Ubuntu 12 and earlier.

18.14.5. Disable WebView

If the NAppGUI CMake script does not detect the native libraries required by the `WebView` control on your system, it will disable it. You can also do this explicitly using this CMake parameter.

```
cmake -DNAPPGUI_WEB=NO -S . -B build
```

By disabling Web support, applications that make use of the `WebView` control will compile and be able to run. The difference is that they will not display Web content in the control, just an empty area (Figure 18.48).

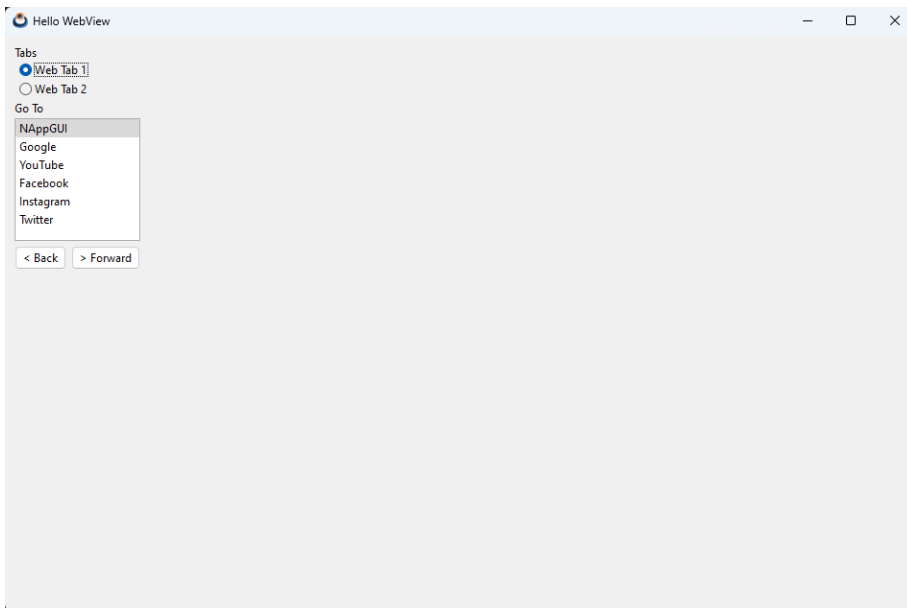

Figure 18.48: Application with Web support disabled.

Disabling Web support will not generate compilation or link errors in applications that use the `WebView`.

18.15. ImageView

ImageView are specialized views in visualizing images and **GIF** animations.

- Use `imageview_create` to create an image control.

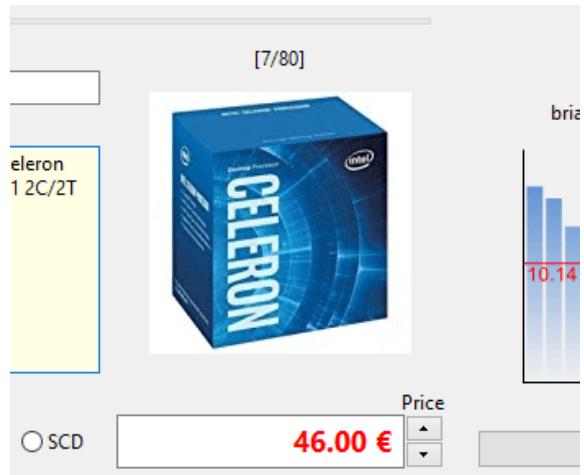

Figure 18.49: ImageView in a panel.

- Use `imageView_image` to set the image that the control will display.
- Use `imageView_scale` to set the image adjustment mode.

18.16. TableView

TableViews are data views that display tabulated information arranged in rows and columns (Figure 18.50), (Figure 18.51), (Figure 18.52). The control enables scroll bars and allows keyboard navigation. In “*Hello TableView!*” (page 563) you have an example of use.

- Use `tableview_create` to create a table view.
- Use `tableview_new_column_text` to add a column.
- Use `tableview_size` to set the default size.

18.16.1. Data connection

Let’s think that a table can contain thousands of records and these can change at any time from different data sources (disk, network, DBMS, etc). For this reason, the TableView **will not maintain any internal cache**. It has been designed with the aim of making a quick visualization of the data, but without going into their management. Ultimately, it is the application that must provide this information in a fluid manner.

- Use `tableview_OnData` to bind the table to the data source.
- Use `tableview_update` to force an update of the table data.

When a table needs to draw its contents, in response to an `OnDraw` event, it will first ask the application for the total number of records via a `ekGUI_EVENT_TBL_NROWS` noti-

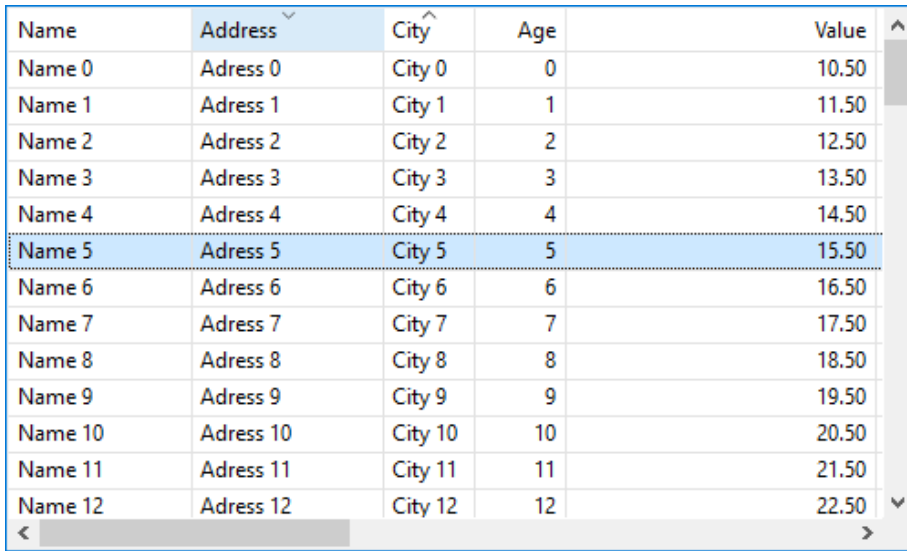

Name	Address	City	Age	Value
Name 0	Adress 0	City 0	0	10.50
Name 1	Adress 1	City 1	1	11.50
Name 2	Adress 2	City 2	2	12.50
Name 3	Adress 3	City 3	3	13.50
Name 4	Adress 4	City 4	4	14.50
Name 5	Adress 5	City 5	5	15.50
Name 6	Adress 6	City 6	6	16.50
Name 7	Adress 7	City 7	7	17.50
Name 8	Adress 8	City 8	8	18.50
Name 9	Adress 9	City 9	9	19.50
Name 10	Adress 10	City 10	10	20.50
Name 11	Adress 11	City 11	11	21.50
Name 12	Adress 12	City 12	12	22.50

Figure 18.50: TableView control in Windows.

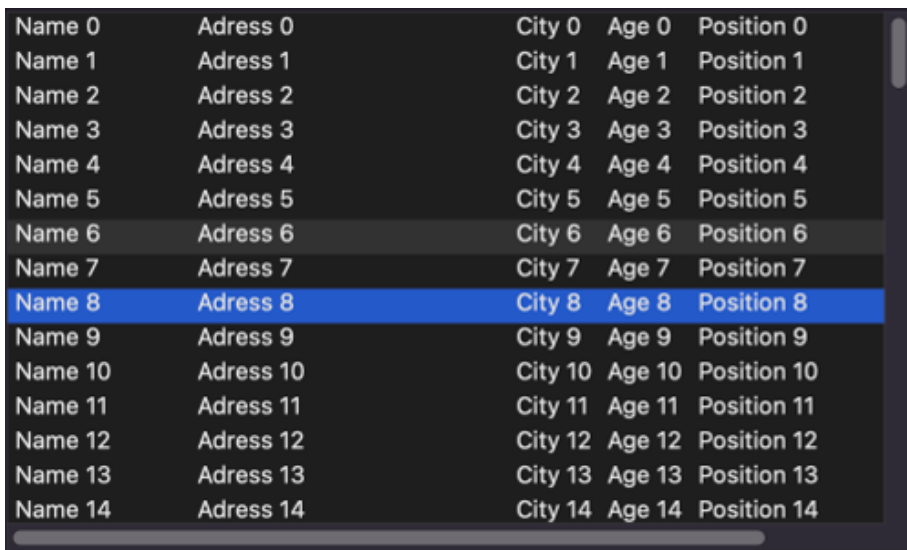

Name 0	Adress 0	City 0	Age 0	Position 0
Name 1	Adress 1	City 1	Age 1	Position 1
Name 2	Adress 2	City 2	Age 2	Position 2
Name 3	Adress 3	City 3	Age 3	Position 3
Name 4	Adress 4	City 4	Age 4	Position 4
Name 5	Adress 5	City 5	Age 5	Position 5
Name 6	Adress 6	City 6	Age 6	Position 6
Name 7	Adress 7	City 7	Age 7	Position 7
Name 8	Adress 8	City 8	Age 8	Position 8
Name 9	Adress 9	City 9	Age 9	Position 9
Name 10	Adress 10	City 10	Age 10	Position 10
Name 11	Adress 11	City 11	Age 11	Position 11
Name 12	Adress 12	City 12	Age 12	Position 12
Name 13	Adress 13	City 13	Age 13	Position 13
Name 14	Adress 14	City 14	Age 14	Position 14

Figure 18.51: TableView control in macOS.

fication. With this it can calculate the size of the document and configure the scroll bars (Figure 18.53). Subsequently, it will launch successive `ekGUI_EVENT_TBL_CELL` events, where it will ask the application for the content of each cell (Figure 18.54). All these requests will be made through the *callback* function set in `tableview_OnData` (Listing 18.8).

TableView will only ask for the content of the visible part at any time.

Name	Address	City	Age	Value
Name 0	Adress 0	City 0	0	10.50
Name 1	Adress 1	City 1	1	11.50
Name 2	Adress 2	City 2	2	12.50
Name 3	Adress 3	City 3	3	13.50
Name 4	Adress 4	City 4	4	14.50
Name 5	Adress 5	City 5	5	15.50
Name 6	Adress 6	City 6	6	16.50
Name 7	Adress 7	City 7	7	17.50
Name 8	Adress 8	City 8	8	18.50
Name 9	Adress 9	City 9	9	19.50
Name 10	Adress 10	Cit...	10	20.50
Name 11	Adress 11	Cit...	11	21.50

Figure 18.52: TableView control in Linux.

Figure 18.53: Ask for the number of rows in the data set.

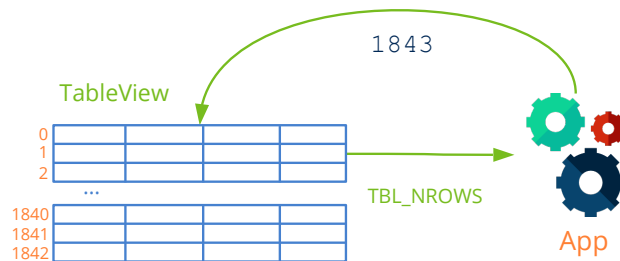
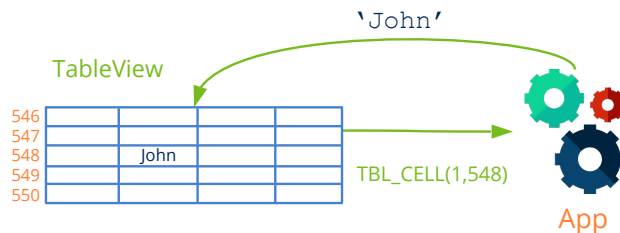

Figure 18.54: Request for the data of a cell.



Listing 18.8: Data connection example.

```

static void i_OnTableData(App *app, Event *e)
{
    uint32_t etype = event_type(e);
    unref(app);

    switch(etype) {
    case ekGUI_EVENT_TBL_NROWS:
    {

```

```

uint32_t *n = event_result(e, uint32_t);
*n = app_num_rows(app);
break;
}

case ekGUI_EVENT_TBL_CELL:
{
    const EvTbPos *pos = event_params(e, EvTbPos);
    EvTbCell *cell = event_result(e, EvTbCell);

    switch(pos->col) {
    case 0:
        cell->text = app_text_column0(app, pos->row);
        break;

    case 1:
        cell->text = app_text_column1(app, pos->row);
        break;

    case 2:
        cell->text = app_text_column2(app, pos->row);
        break;
    }

    break;
}
}

TableView *table = tableview_create();
tableview_OnData(table, listener(app, i_OnTableData, App));
tableview_update(table);

```

18.16.2. Data cache

As we have already commented, at each instant the table will only show a small portion of the data set. In order to supply this data in the fastest possible way, the application can keep a cache with those that will be displayed next. To do this, before starting to draw the view, the table will send an `ekGUI_EVENT_TBL_BEGIN` type event where it will indicate the range of rows and columns that need updating (Figure 18.55). This event will precede any `ekGUI_EVENT_TBL_CELL` seen in the previous section. In the same way, once all the visible cells have been updated, the `ekGUI_EVENT_TBL_END` event will be sent, where the application will be able to free the resources in the cache (Listing 18.9).

Listing 18.9: Example of using data cache.

```

static void i_OnTableData(App *app, Event *e)
{

```

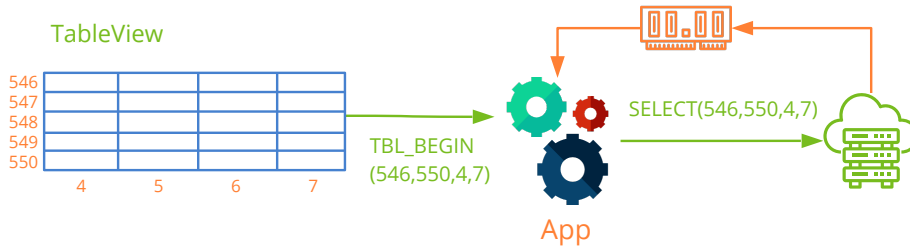

Figure 18.55: Use of data cache.

```

uint32_t etype = event_type(e);
unref(app);

switch(etype) {
case ekGUI_EVENT_TBL_NROWS:
{
    uint32_t *n = event_result(e, uint32_t);
    *n = app_num_rows(app);
    break;
}

case ekGUI_EVENT_TBL_BEGIN:
{
    const EvTbRect *rect = event_params(e, EvTbRect);
    app->cache = app_fill_cache(app, rect->strow, rect->edrow, rect->stcol,
        ↪ rect->edcol);
    break;
}

case ekGUI_EVENT_TBL_CELL:
{
    const EvTbPos *pos = event_params(e, EvTbPos);
    EvTbCell *cell = event_result(e, EvTbCell);
    cell->text = app_get_cache(app->cache, pos->row, pos->col);
    break;
}

case ekGUI_EVENT_TBL_END:
    app_delete_cache(app->cache);
    break;
}

TableView *table = tableview_create();
tableview_OnData(table, listener(app, i_OnTableData, App));
tableview_update(table);

```

18.16.3. Multiple selection

When we navigate through a `TableView` we can activate the multiple selection, which will allow us to mark more than one row of the table (Figure 18.56).

- Use `tableView_multisel` to turn multiselect on or off.
- Use `tableView_selected` to get the selected rows.
- Use `tableView_select` to select a set of rows.
- Use `tableView_deselect` to deselect.
- Use `tableView_deselect_all` to uncheck all rows.
- Use `tableView_OnSelect` to receive an event when the selection changes.

Name	Address	City	Age	Value
Name 0	Adress 0	City 0	0	10.50
Name 1	Adress 1	City 1	1	11.50
Name 2	Adress 2	City 2	2	12.50
Name 3	Adress 3	City 3	3	13.50
Name 4	Adress 4	City 4	4	14.50
Name 5	Adress 5	City 5	5	15.50
Name 6	Adress 6	City 6	6	16.50
Name 7	Adress 7	City 7	7	17.50
Name 8	Adress 8	City 8	8	18.50
Name 9	Adress 9	City 9	9	19.50
Name 10	Adress 10	City 10	10	20.50
Name 11	Adress 11	City 11	11	21.50
Name 12	Adress 12	City 12	12	22.50

Figure 18.56: TableView with multiple selection.

18.16.4. Table navigation

Navigating a `TableView` works the same as other similar controls, such as the file explorer. We can use the keyboard when the table has focus. It will also respond to mouse events to select rows and move scroll bars.

- Use `tableView_focus_row` to move keyboard focus to a row.
- Use `tableView_get_focus_row` to get the row that has keyboard focus.
- Use `tableView_hkey_scroll` to set horizontal scrolling.
- `[UP]`/`[DOWN]` to move row by row.

- [LEFT]/[RIGHT] to scroll horizontally.
- [PAGEUP]/[PAGEDOWN] advance or reverse a page.
- [HOME] goes to the beginning of the table.
- [END] goes to the end of the table.
- [CTRL]+click multiple selection with the mouse.
- [SHIFT]+[UP]/[DOWN] multiple selection with the keyboard.

In multiple selection, an **automatic de-selection of the rows** will occur whenever we click releasing [CTRL] or press any navigation key releasing [SHIFT]. If we want to navigate without losing the previous selection, we must activate the `preserve` flag in `tableview_multisel`.

18.16.5. Configure columns

We have different options to configure the interaction with the different columns of the table:

- Use `tableview_header_title` to set the title of a column. Multiple lines are accepted including '\n' characters (Figure 18.58).
- Use `tableview_header_align` to set the alignment of a column header.
- Use `tableview_header_resizable` to allow or disallow column resizing.
- Use `tableview_column_width` to set the width of a column.
- Use `tableview_column_limits` to set limits on the width.
- Use `tableview_column_resizable` to allow the column to be stretched or collapsed.
- Use `tableview_column_freeze` to freeze columns (Figure 18.57).

18.16.6. Notifications in tables

We have different events to capture actions that the user could perform on the (Listing 18.10) table.

- Use `tableview_header_clickable` to allow clicking on the header.
- Use `tableview_OnRowClick` to notify the click on a row.
- Use `tableview_OnHeaderClick` to notify the click on the header.

Name	Address	1	Extra Data 2
Name 0	Adress 0	1 0	Extra Data 2 0
Name 1	Adress 1	1 1	Extra Data 2 1
Name 2	Adress 2	1 2	Extra Data 2 2
Name 3	Adress 3	1 3	Extra Data 2 3
Name 4	Adress 4	1 4	Extra Data 2 4
Name 5	Adress 5	1 5	Extra Data 2 5
Name 6	Adress 6	1 6	Extra Data 2 6
Name 7	Adress 7	1 7	Extra Data 2 7
Name 8	Adress 8	1 8	Extra Data 2 8
Name 9	Adress 9	1 9	Extra Data 2 9
Name 10	Adress 10	1 10	Extra Data 2 10
Name 11	Adress 11	1 11	Extra Data 2 11
Name 12	Adress 12	1 12	Extra Data 2 12

Figure 18.57: Columns 0 and 1 frozen. Animation in https://nappgui.com/img/gui/tableview_freeze.gif.

Figure 18.58: Header with multiple lines.

Name	Address	Extra Data 2	Extra Data 3
Name 0	Adress 0	Extra Data 2 0	Extra Data 3
Name 1	Adress 1	Extra Data 2 1	Extra Data
Name 2	Adress 2	Extra Data 2 2	Extra Data
Name 3	Adress 3	Extra Data 2 3	Extra Data
Name 4	Adress 4	Extra Data 2 4	Extra Data

```

static void i_OnRowClick(App *app, Event *e)
{
    const EvTbRow *p = event_params(e, EvRow);
    on_row_click(app, p->row, p->sel);
}

static void i_OnHeaderClick(App *app, Event *e)
{
    const EvButton *p = event_params(e, EvButton);
    on_header_click(app, p->index);
}

tableview_OnRowClick(table, listener(app, i_OnRowClick, App));
tableview_OnHeaderClick(table, listener(app, i_OnHeaderClick, App));

```

18.16.7. Table appearance

There are different options to change the appearance of the table.

- Use `tableview_font` to change the font.
- Use `tableview_header_visible` to show or hide the header.

- Use `tableView_scroll_visible` to show or hide the scroll bars.
- Use `tableView_grid` to show or hide the inner lines (Figure 18.59), (Figure 18.60).
- Use `tableView_header_height` to force the header height.
- Use `tableView_row_height` to force the row height.

Name	Address	City	Age	Value
Name 0	Address 0	City 0	0	10.50
Name 1	Address 1	City 1	1	11.50
Name 2	Address 2	City 2	2	12.50
Name 3	Address 3	City 3	3	13.50
Name 4	Address 4	City 4	4	14.50
Name 5	Address 5	City 5	5	15.50
Name 6	Address 6	City 6	6	16.50
Name 7	Address 7	City 7	7	17.50
Name 8	Address 8	City 8	8	18.50
Name 9	Address 9	City 9	9	19.50
Name 10	Address 10	City 10	10	20.50
Name 11	Address 11	City 11	11	21.50
Name 12	Address 12	City 12	12	22.50
Name 13	Address 13	City 13	13	23.50

Figure 18.59: UITableView with no interior lines.

Name	Address	City	Age	Value
Name 0	Address 0	City 0	0	10.50
Name 1	Address 1	City 1	1	11.50
Name 2	Address 2	City 2	2	12.50
Name 3	Address 3	City 3	3	13.50
Name 4	Address 4	City 4	4	14.50
Name 5	Address 5	City 5	5	15.50
Name 6	Address 6	City 6	6	16.50
Name 7	Address 7	City 7	7	17.50
Name 8	Address 8	City 8	8	18.50
Name 9	Address 9	City 9	9	19.50
Name 10	Address 10	City 10	10	20.50
Name 11	Address 11	City 11	11	21.50
Name 12	Address 12	City 12	12	22.50
Name 13	Address 13	City 13	13	23.50

Figure 18.60: UITableView with interior lines.

18.17. SplitView

The **SplitView** are views divided into two parts, where in each of them we place another view or a panel. The dividing line is scrollable, which allows resizing both halves,

dividing the total size of the control between the children (Figure 18.61), (Figure 18.62), (Figure 18.63). In “*Hello SplitView!*” (page 570) you have an example of use.

- Use `splitview_horizontal` to create a split view.
- Use `splitview_size` to set the initial size.

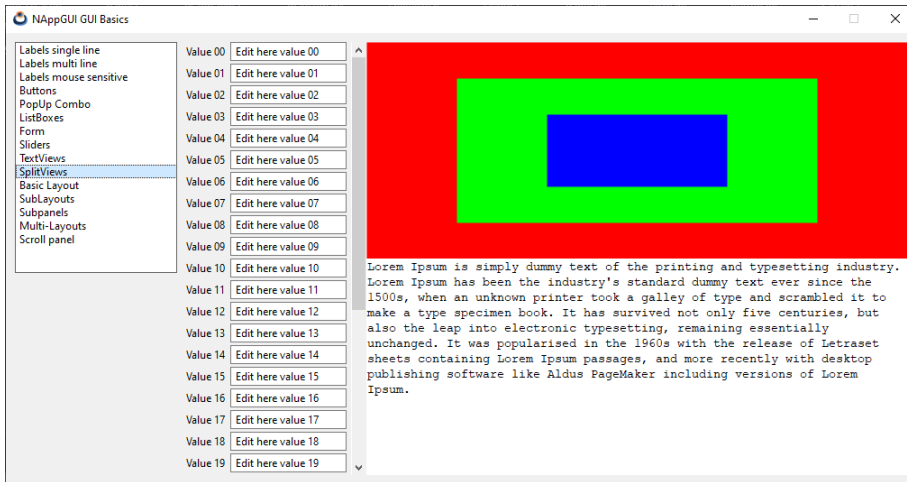

Figure 18.61: SplitView in Windows.



Figure 18.62: SplitView in macOS.

18.17.1. Add controls

There are several functions for adding “child” controls to the splitview. The first call to any of them will place the view or panel on the left or top side. The second call will be

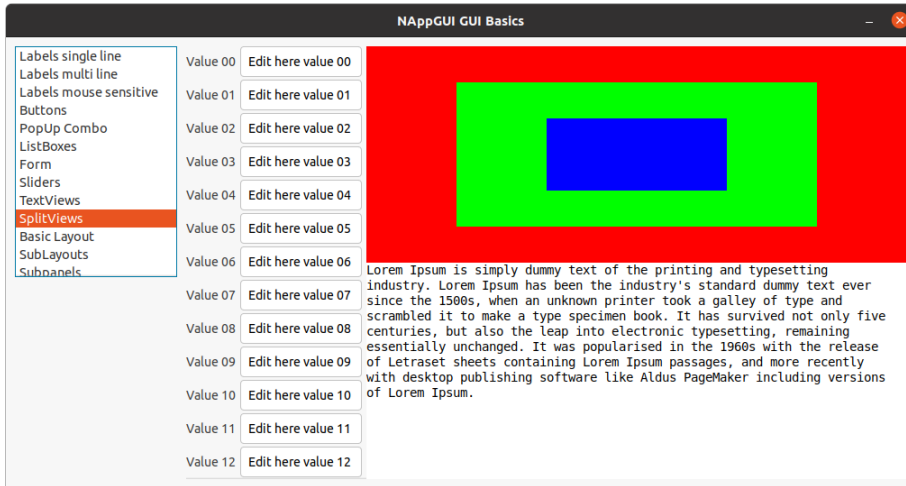

Figure 18.63: SplitView in Linux.

on the right or lower side. Successive calls will generate an error.

- Use `splitview_view` to add a custom view.
- Use `splitview_panel` to add a panel.

18.17.2. Split modes

We have two modes of behavior of the dividing bar and both are activated from this function:

- Use `splitview_pos` to set the mode of the splitter.
- Proportional mode: The position of the divider will always remain constant with respect to the size of the splitview. That is, a value of 0.3 means that the left view will always occupy 1/3 of the total size and the right view 2/3. To do this, indicate a value between 0 and 1 in the `pos` parameter.
- Fixed mode: Resizing the splitview will always leave one of the parts with a constant size. If `pos > 1` the left/top child will keep the indicated number of pixels. On the contrary, if `pos < 0` the same will happen with the right/bottom view.

The ratio or value will change if the user drags the dividing line, but the operating mode will not.

18.18. Layout

A **Layout** is a virtual and transparent grid always linked with a `Panel` which serves to locate the different interface elements (Figure 18.64). Its inner cells have the ability to be automatically sized according to their content, which results in great portability because it is not necessary to indicate specific coordinates or sizes for the controls. To illustrate the concept, we will slightly simplify the code of “*Hello Edit and UpDown!*” (page 535) (Listing 18.11), whose result we can see in (Figure 18.65).

- Use `layout_create` to create a new layout.
- Use `layout_label` and similars to place controls in the different cells.

Layout (2, 4)

Label (0, 0)	<input type="checkbox"/> CheckBox (1, 0)
(0, 1)	<input type="radio"/> RadioButton1 (1, 1)
(0, 2)	<input checked="" type="radio"/> RadioButton2 (1, 2)
Button	<input type="range"/> (1, 3)

Figure 18.64: A layout is used to locate controls in the panel area.

Listing 18.11: Layout with two columns and five rows.

```
Layout *layout = layout_create(2, 5);
Label *label1 = label_create();
Label *label2 = label_create();
Label *label3 = label_create();
Label *label4 = label_create();
Label *label5 = label_create();
Edit *edit1 = edit_create();
Edit *edit2 = edit_create();
Edit *edit3 = edit_create();
Edit *edit4 = edit_create();
Edit *edit5 = edit_create();
label_text(label1, "User Name:");
label_text(label2, "Password:");
label_text(label3, "Address:");
label_text(label4, "City:");
label_text(label5, "Phone:");
edit_text(edit1, "Amanda Callister");
edit_text(edit2, "aQwe56nhjJk");
edit_text(edit3, "35, Tuam Road");
edit_text(edit4, "Galway - Ireland");
edit_text(edit5, "+35 654 333 000");
edit_passmode(edit2, TRUE);
layout_label(layout, label1, 0, 0);
layout_label(layout, label2, 0, 1);
layout_label(layout, label3, 0, 2);
layout_label(layout, label4, 0, 3);
```

```

layout_label(layout, label5, 0, 4);
layout_edit(layout, edit1, 1, 0);
layout_edit(layout, edit2, 1, 1);
layout_edit(layout, edit3, 1, 2);
layout_edit(layout, edit4, 1, 3);
layout_edit(layout, edit5, 1, 4);

```

User Name:	Amanda Callister
Password:	*****
Address:	35, Tuam Road
City:	Galway - Ireland
Phone:	+35 654 333 000

Figure 18.65: Result of (Listing 18.11).

18.18.1. Natural sizing

The result of (Figure 18.65), although it is not very aesthetic, it is what we call **natural sizing** which is the default layout applied depending on the content of the cells. In (Table 18.2) we have the default measurements of each control. The column width is fixed to that of the widest element and the height of the rows is calculated in the same way. The final size of the layout will be the sum of the measures of both columns and rows.

Control	Width	Height
Label	Adjusted to the text.	Adjusted to the text considering '\n'.
Button (push)	Adjusted to text + margin.	According to the theme of the OS.
Button (check/radio)	Adjusted to text + icon.	Adjusted to the icon.
Button (flat)	Adjusted to the icon + margin.	Adjusted to the icon + margin.
PopUp	Adjusted to the longest text.	According to the theme of the OS.
Edit	100 Units (px).	Adjusted to text + margin.
Combo	100 Units (px).	According to the theme of the OS.
ListBox	128 px or <code>listbox_size</code> .	128 px or <code>listbox_size</code> .
UpDown	According to the theme of the OS.	According to the theme of the OS.
Slider (horizontal)	100 Units (px).	According to the theme of the OS.
Slider (vertical)	According to the theme of the OS.	100 Units (px).
Progress	100 Units (px).	According to the theme of the OS.

Control	Width	Height
<code>View</code>	128 px or <code>view_size</code> .	128 px or <code>view_size</code> .
<code>TextView</code>	256 px or <code>textview_size</code> .	144 px or <code>textview_size</code> .
<code>WebView</code>	256 px or <code>webview_size</code> .	144 px or <code>webview_size</code> .
<code>ImageView</code>	64 px or <code>imageview_size</code> .	64 px or <code>imageview_size</code> .
<code>TableView</code>	256 px or <code>tableview_size</code> .	128 px or <code>tableview_size</code> .
<code>SplitView</code>	128 px or <code>splitview_size</code> .	128 px or <code>splitview_size</code> .
<code>Panel</code>	Natural size.	Natural size.
<code>Panel</code> (with scroll)	256 px or <code>panel_size</code> .	256 px or <code>panel_size</code> .

Table 18.2: Natural dimensioning of controls.

The margins and constants applied to the controls are those necessary to comply with the **human guidelines** of each window manager. This means that a `PushButton` with the text "Hello" will not have the same dimensions in WindowsXP as in macOS Mavericks or Ubuntu 16.

Empty cells will be 0-sized and will not affect the composition.

18.18.2. Margins and format

The natural sizing we have just seen adjusts the panel to the minimum size necessary to correctly house all the controls, but it is not always aesthetic. We can shape it by adding margins or forcing a given size for rows and columns (Listing 18.12) (Figure 18.66).

- Use `layout_hsize` to force the width of a column.
- Use `layout_vsize` to force the height of a row.
- Use `layout_hmargin` to establish an inter-column margin.
- Use `layout_vmargin` to establish an inter-row margin.
- Use `layout_margin` to set a margin at the edge of the layout.

Listing 18.12: Applying format to (Listing 18.11).

```
layout_hsize(layout, 1, 235);
layout_hmargin(layout, 0, 5);
layout_vmargin(layout, 0, 5);
layout_vmargin(layout, 1, 5);
layout_vmargin(layout, 2, 5);
layout_vmargin(layout, 3, 5);
layout_margin(layout, 10);
```

Figure 18.66: Result of (Listing 18.12).

User Name:	Amanda Callister
Password:	*****
Address:	35, Tuam Road
City:	Galway - Ireland
Phone:	+35 654 333 000

18.18.3. Alignment

It is usual for the width of a control to be less than the width of the column that contains it, either because a fixed width has been forced or because there are wider elements in the same column. In these cases, we can indicate the horizontal or vertical alignment of the control with respect to the cell (Figure 18.67). In (Table 18.3) you have the default alignments.

- Use `layout_halign` to change the horizontal alignment of a cell.
- Use `layout_valign` to change the vertical alignment of a cell.

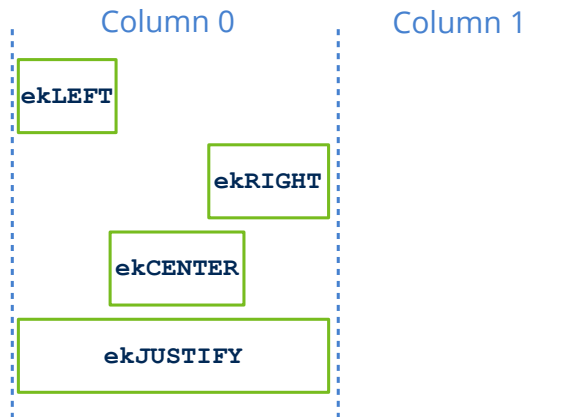

Figure 18.67: Horizontal alignment.

Control	Horizontal	Vertical
Label	ekLEFT	ekCENTER
Button (push)	ekJUSTIFY	ekCENTER
Button (others)	ekLEFT	ekCENTER
PopUp	ekJUSTIFY	ekCENTER
Edit	ekJUSTIFY	ekTOP

Control	Horizontal	Vertical
Edit (multiline)	ekJUSTIFY	ekJUSTIFY
Combo	ekJUSTIFY	ekCENTER
ListBox	ekJUSTIFY	ekJUSTIFY
UpDown	ekJUSTIFY	ekJUSTIFY
Slider (horizontal)	ekJUSTIFY	ekCENTER
Slider (vertical)	ekCENTER	ekJUSTIFY
Progress	ekJUSTIFY	ekCENTER
View	ekJUSTIFY	ekJUSTIFY
TextView	ekJUSTIFY	ekJUSTIFY
ImageView	ekJUSTIFY	ekJUSTIFY
TableView	ekJUSTIFY	ekJUSTIFY
SplitView	ekJUSTIFY	ekJUSTIFY
Layout (sublayout)	ekJUSTIFY	ekJUSTIFY
Panel	ekJUSTIFY	ekJUSTIFY

Table 18.3: Default alignment of controls.

18.18.4. Sub-layouts

Consider now the panel of (Figure 18.68). It is not difficult to realize that this arrangement does not fit in any way in a rectangular grid, so it is time to use **sublayouts**. In addition to individual controls, a cell also supports another layout, so we can divide the original panel into as many parts as necessary until the desired layout is achieved. The main layout will size each sublayout recursively and integrate it into the final composition. In “*Hello Sublayout!*” (page 595) you have the code that generates this example.

- Use `layout_layout` to assign a complete layout to a cell in another layout.

In this case we have applied the philosophy of divide and conquer, to ensure that each part fits into an individual grid (Figure 18.69). Each sublayout has been coded in an independent function to give greater consistency to the code, applying margins and format individually within each of them (Listing 18.13).

Listing 18.13: Sublayout integration (partial).

```
static Layout *i_main_layout(void)
{
    Layout *layout1 = layout_create(1, 2);
```

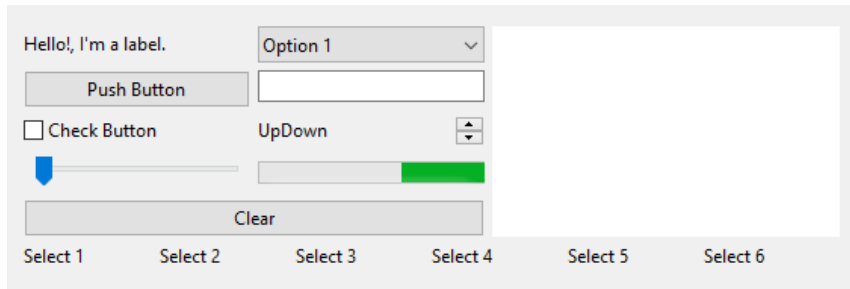

Figure 18.68: Complex panel composition.

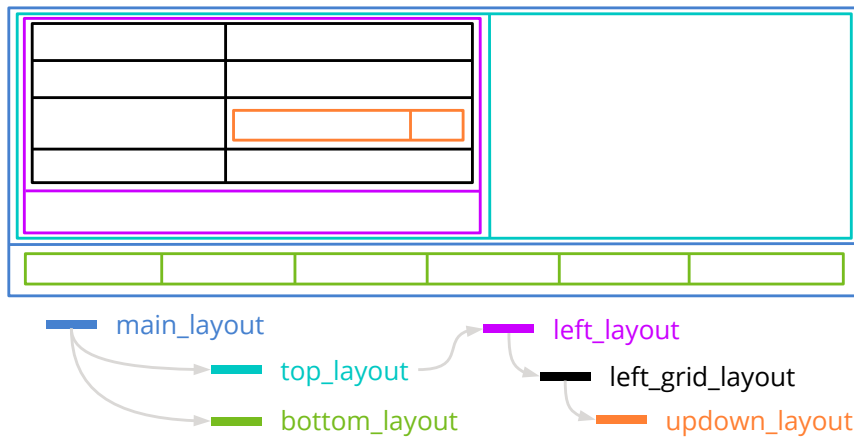

Figure 18.69: Sublayouts needed to compose the (Figure 18.68) panel.

```

Layout *layout2 = i_top_layout();
Layout *layout3 = i_bottom_layout();
layout_layout(layout1, layout2, 0, 0);
layout_layout(layout1, layout3, 0, 1);
layout_margin(layout1, 5);
layout_vmargin(layout1, 0, 5);
return layout1;
}

```

18.18.5. Cell expansion

On certain occasions, the size of a layout is forced by external conditions. This happens when we have a sublayout in a cell with `ekJUSTIFY` alignment (internal expansion) or when the user changes the size of a resizable window (external expansion). This will produce an “pixel excess” between the natural sizing and the actual cell size (Figure 18.70). This situation is resolved by distributing the pixel surplus equally among all the sublayout columns, which in turn, will be recursively expanding until they reach an empty cell or an individual control. We can change this equitable distribution through these functions:

- Use `layout_hexpand` to expand a single cell and leave the rest with its default size.
- Use `layout_hexpand2` to expand two cells indicating the growth rate of each.
- Use `layout_hexpand3` to expand three cells.

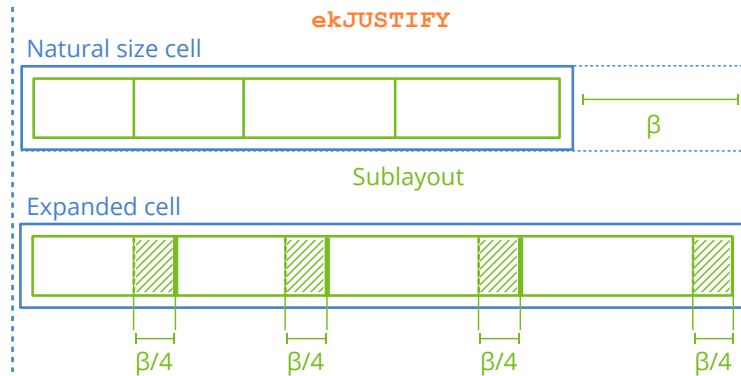

Figure 18.70: When the size of the sublayout is given by external conditions, the excess of pixels is equally distributed between the columns (horizontal expansion) and rows (vertical expansion).

The vertical expansion works exactly the same, distributing the excess space between the rows of the layout.

18.18.6. Dynamic interfaces

In most cases, especially in simple applications, the user interface will remain unchanged throughout the execution, regardless of possible re-sizing. That is, a layout is generated, the necessary controls are placed in it and linked to the main window through a panel. In more complex applications, part of the interface may need to change at run time, ensuring that these changes maintain the consistency of the initial design in terms of sizes, margins, and placement of elements. NAppGUI provides three mechanisms for implementing changes at runtime.

- “Multi-layout panel” (page 474).
- “Replacing panels” (page 357).
- “Dynamic layouts” (page 357).

It is important to remember that, after each change, we must update the window so that the composer recomputes and updates the view. This is done using the functions: `layout_update`, `panel_update` or `window_update`. The three calls are equivalent.

18.18.7. Replacing panels

- Use `layout_panel_replace` to change a panel at runtime.

This functionality allows us to replace an existing, and possibly visible, panel with another generated at runtime. The change will be associated with a re-composition of the window that will be carried out automatically and transparently for the programmer. This is precisely what the “*Hello GUI!*” (page 526) application does as we select elements from the side `ListBox` (Listing 18.14) (Figure 18.71).

Listing 18.14: Creating and changing a panel at runtime.

```
static void i_set_panel(App *app, const uint32_t index)
{
    Panel *panel = NULL;
    switch (index) {
        /* ... */
        case 5:
            panel = listboxes();
            break;
        case 6:
            panel = form_basic();
            break;
        /* ... */
    }

    layout_panel_replace(app->layout, panel, 1, 0);
}
```

It is only possible to replace one panel with another. It is not possible to do this with other types of controls.

The existing panel and its internal elements will be completely destroyed, making it impossible to recover them again.

18.18.8. Dynamic layouts

- Use `layout_ncols` to get the number of columns in a layout.
- Use `layout_nrows` to get the number of rows in a layout.
- Use `layout_insert_col` to insert a new column into a layout.
- Use `layout_insert_row` to insert a new row into a layout.
- Use `layout_remove_col` to remove a column from a layout.
- Use `layout_remove_row` to remove a row from a layout.

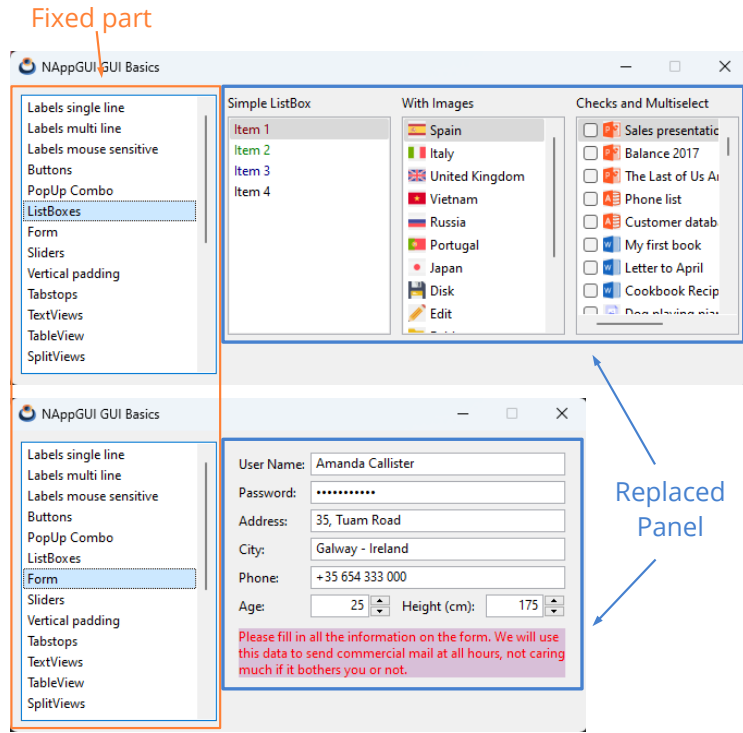

Figure 18.71: Effect of replacing a panel.

By **dynamic layout** we understand the possibility of adding or deleting rows and columns to an existing layout linked to a panel. As with panel replace, modifying a layout involves re-computing the interface and updating the window content. In *“Hello Dynamic Layout!”* (page 603) you have an example of use. Inserting a row or column will create a series of empty cells of zero size, which will have no visual impact on the window (nothing will apparently change). It will be when adding controls or sublayouts to said cells that the change is perceived in the window. On the other hand, deleting a row or column will imply the destruction of all the content of the cells, both controls and sublayouts, making it impossible to recover them again.

It is not possible to delete all rows or all columns. At least 1x1 cells are required.

When deleting a row or column, all the elements in the cells will be destroyed and cannot be recovered.

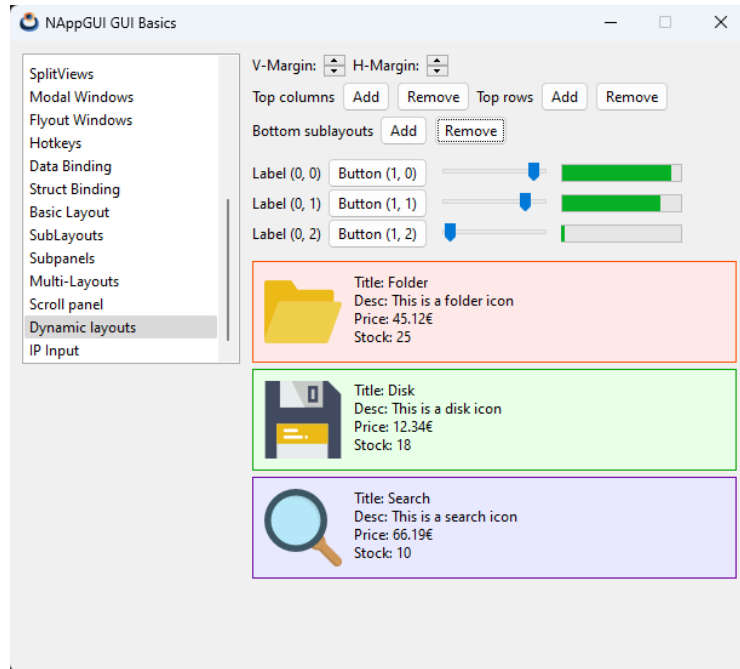

Figure 18.72: Add/delete rows/columns in a layout. Animation at https://nappgui.com/img/gui/dynamic_layout.gif.

18.18.9. Tabstops

Normally we will use the [TAB] key and the [SHIFT]+[TAB] combination to navigate through the different controls of a window or form. Terms like **taborder** or **tabstop** refer to both the navigation order and the membership (or not) of an element in said list. While it is possible to arrange the elements of a *tab-list* randomly, layouts provide a coherent natural order based on the placement of controls. By default, each layout creates a *tab-list* going through all its cells by rows (Figure 18.73), but we can change it:

- Use `layout_taborder` to arrange the *tab-list* by rows or columns.
- Use `layout_tabstop` to add or remove controls from the *tab-list*.

Not every cell in a layout has to be a *tabstop*, since it doesn't make sense for static controls like `Label` to receive keyboard focus. In (Table 18.4) you have which controls are included in that list. With `layout_tabstop` you can add or remove controls from the *tab-list*.

Control	Included
<code>Label</code>	NO



Figure 18.73: Taborder by rows in layouts and sublayouts. Animation in <https://nappgui.com/img/gui/tabstops.gif>.

Control	Included
Button	YES
PopUp	YES
Edit	YES
Combo	YES
ListBox	YES
UpDown	NO
Slider	YES
Progress	NO
View	NO
TextView	NO
WebView	NO
ImageView	NO
TableView	YES
SplitView	YES (children)
Layout (sublayout)	YES
Panel	YES (children)

Table 18.4: Controls included in the *tab-list*.

When the taborder enters a sublayout, it will follow the local order of the latter. When exiting the sublayout it will continue with the main order.

18.19. Cell

Cells are the inner elements of a “*Layout*” (page 350) and will house a control or a sublayout (Figure 18.74).

- Use `layout_cell` to get the cell.
- Use `cell_control` to get the control inside.
- Use `cell_layout` to get the inner sublayout.
- Use `cell_enabled` to enable or disable the controls.
- Use `cell_visible` to show and hide the content.
- Use `cell_padding` to set the (Figure 18.75) padding.

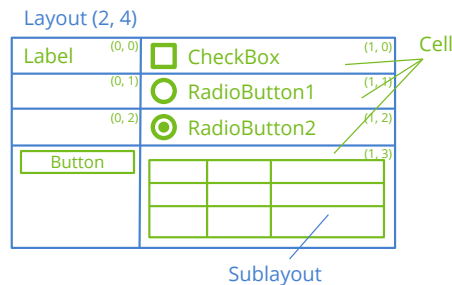

Figure 18.74: Cells inside a Layout

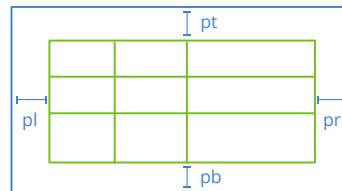

Figure 18.75: Interior padding of a cell.

18.20. Panel

A **Panel** is a control within a window that groups other controls. It defines its own reference system, that is, if we move a panel all its descendants will move in unison since their locations will be relative to its origin. It will support other (sub)-panels as descendants, which allows to form a **Window Hierarchy** (Figure 18.76). For portability, this **Gui** library does not support specific coordinates and sizes for elements linked to a panel, but the association is carried out by a `Layout` object which is responsible for calculating at runtime the final locations of controls based on the platform and window manager. In “*Hello Subpanel!*” (page 598) you have an elementary example of using panels.

- Use `panel_create` to create a new panel.

- Use `panel_scroll` to create a panel with scroll bars.
- Use `panel_custom` to create a new fully configurable panel.
- Use `panel_layout` to add child controls to the panel.
- Use `panel_size` to set the default size of the visible area.

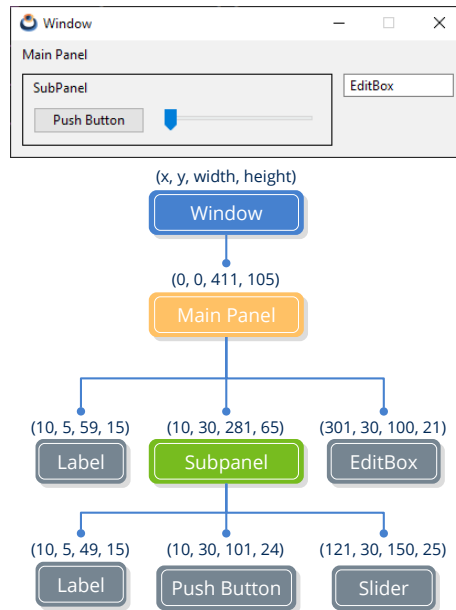

Figure 18.76: Window hierarchy.

18.20.1. Multi-layout panel

Each panel supports several layouts and allows you to switch between them at runtime (Figure 18.77). This allows to create dynamic responsive interfaces with very little effort, since the panel itself is responsible for linking and sizing the controls according to the active layout in each case. In “*Hello Multi-layout!*” (page 599) you have an example.

- Use `panel_visible_layout` to change the layout.

Because the layouts are logical structures outside the window hierarchy, they can share controls as they are linked to the same panel (Figure 18.78). What is not allowed is to use the same objects in different panels, due to the hierarchy concept.

Unlike panels, layouts do not create any native control (GtkWidget, HWND, NSView, etc.).

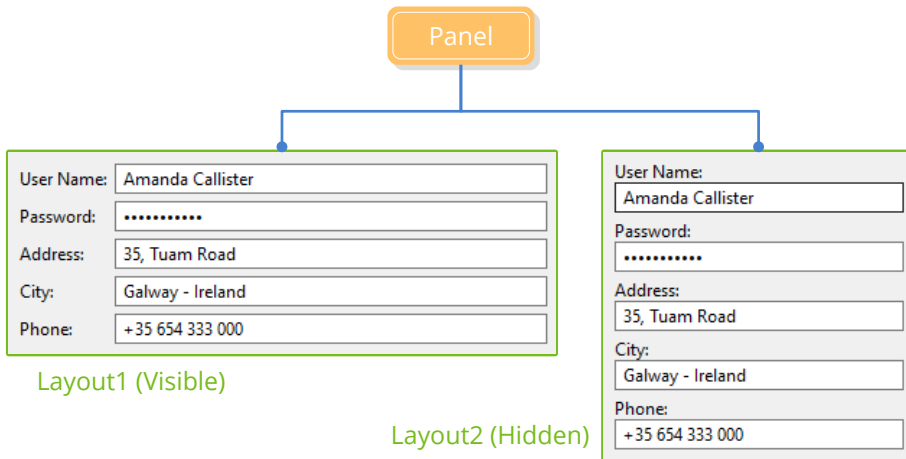

Figure 18.77: Panel with two different organizations for the same controls.

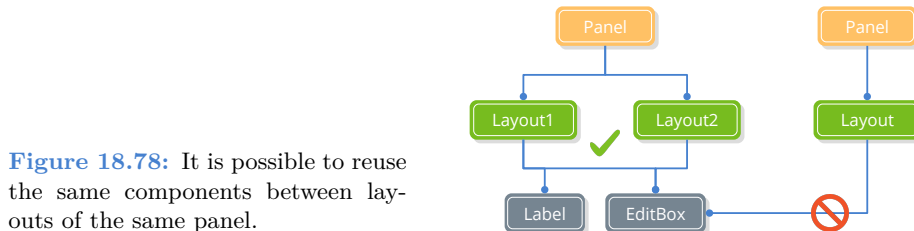

Figure 18.78: It is possible to reuse the same components between layouts of the same panel.

18.20.2. Understanding panel sizing

We are going to show, by means of an example, the logic behind the composition and dimensioning of panels. We start with (Listing 18.15) where we create a relatively large panel in height.

Listing 18.15: Composition of a panel with multiple edit rows.

```
static Window *i_window(void)
{
    uint32_t i, n = 20;
    Window *window_create(ekWINDOW_STDRES);
    Panel *panel = panel_create();
    Layout *layout = layout_create(2, n);

    for (i = 0; i < n; ++i)
    {
        char_t text[64];
        Label *label = label_create();
        Edit *edit = edit_create();
        bstd_sprintf(text, sizeof(text), "Value %02d", i);
        label_text(label, text);
        bstd_sprintf(text, sizeof(text), "Edit here value %02d", i);
```

```

    edit_text(edit, text);
    layout_label(layout, label, 0, i);
    layout_edit(layout, edit, 1, i);
}

for (i = 0; i < n - 1; ++i)
    layout_vmargin(layout, i, 3);

layout_hmargin(layout, 0, 5);
layout_margin4(layout, 10, 10, 10, 10);
panel_layout(panel, layout);
window_panel(window, panel);
return window;
}

```

- Lines 3-6 create the window, panel, and layout.
- Loop 8-19 adds various labels and edit boxes to the layout.
- Loop 21-22 establishes a small gap between rows.
- Lines 24-25 establish a column spacing and border margin.
- Lines 26-27 link the layout to the panel and the layout to the window.

The result of this code is the “*Natural sizing*” (page 351) of the panel (Figure 18.79), which defaults to a width of 100 pixels for the editing controls. Labels fit to the text they contain. Separations and margins have also been applied.

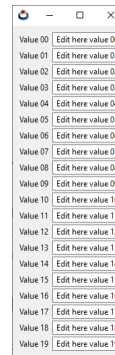

Figure 18.79: Natural sizing of the panel defined in (Listing 18.15).

In this case it is possible to resize the window, since we have used the `ekWINDOW_STDRES` flag when creating it (Figure 18.80).

This behavior may not be the most appropriate for the case at hand. By default, the layout performs the “*Cell expansion*” (page 355) proportionally. But what we really want is to “stretch” the editing controls so that the rows keep their default height (Listing 18.16).

Listing 18.16: Change in horizontal and vertical expansion.

Figure 18.80: Behavior of the panel when the window grows.



```
Layout *layout = layout_create(2, n + 1);
...
layout_hexpand(layout, 1);
layout_vexpand(layout, n);
```

The previous lines cause the horizontal expansion to fall exclusively on column 1 (that of the EditBoxes). On the other hand, an extra empty row has been created, pouring all the vertical expansion into it (Figure 18.81).

Figure 18.81: Desired behavior, when the window expands.

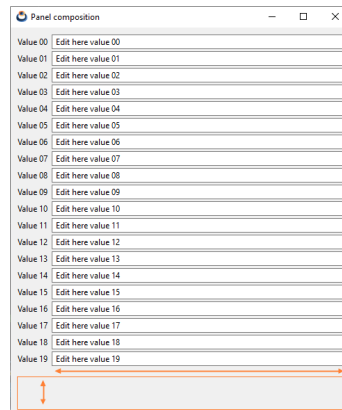

Although the panel now behaves correctly when the window grows, we have difficulties when we want to “shrink” it below a certain limit (Figure 18.82). This is because natural dimensioning imposes a minimum size, since there comes a time when it is impossible to reduce the controls associated with the layout.

This can be a problem as we may have panels large enough that they even exceed the size of the monitor and cannot be fully displayed. To solve this, we can set a default size

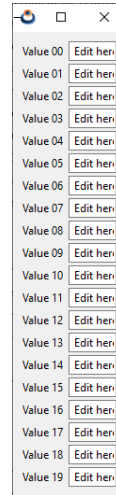

Figure 18.82: Minimum panel size.

for the entire panel (Listing 18.17), which will be the one displayed when the window starts (Figure 18.83).

Listing 18.17: Panel default size.

```
...
panel_size(panel, s2df(400, 300));
...
```

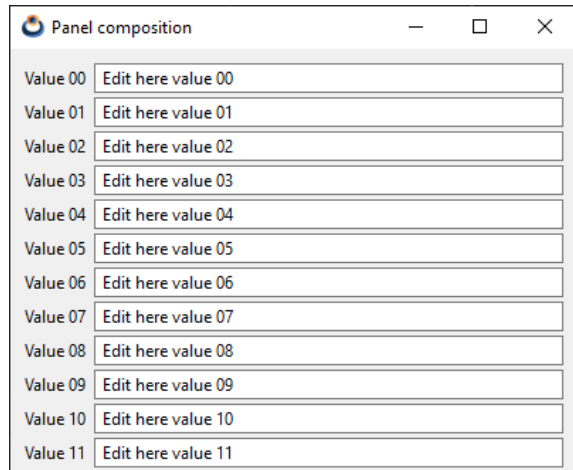

Figure 18.83: Natural sizing, forced to 400x300.

This command decouples, in a way, the size of the panel from the size of its content. In this way, the Layout is free to reduce the size of the view, regardless of whether or not it can display the entire content (Figure 18.84).

And finally, if we want, we can create the panel with scroll bars (Listing 18.18) and scroll through the non-visible content (Figure 18.85).

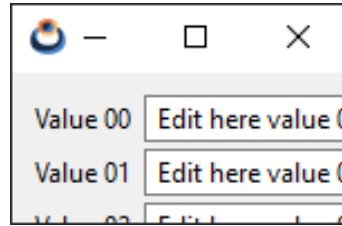

Figure 18.84: Panel boundary reduction.

Listing 18.18: Panel with scroll bars.

```
...
Panel *panel = panel_scroll(TRUE, TRUE);
...
```

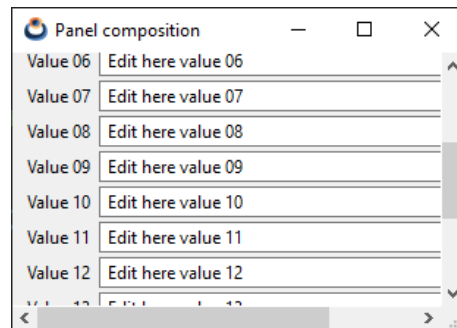

Figure 18.85: Panel with scroll bars.

And, of course, everything said will work the same on any platform (Figure 18.86).

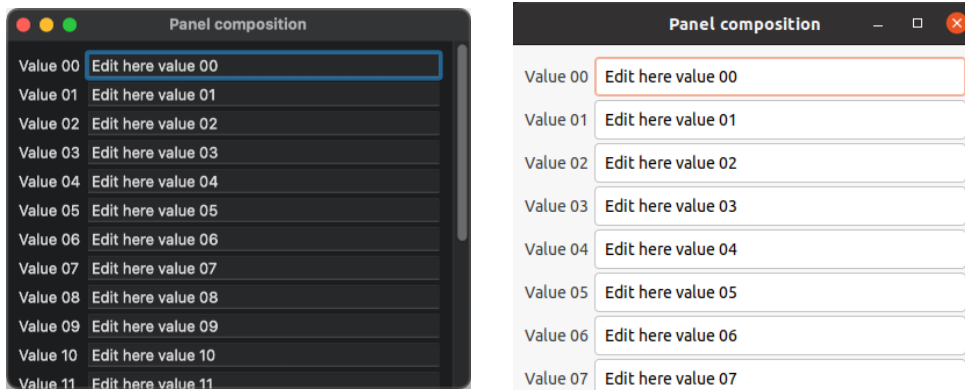

Figure 18.86: Our panel running on macOS and Linux.

18.21. Window

Window objects are the highest-level containers within the user interface (Figure 18.87). They are made up of the title bar, where the close, maximize and minimize buttons are

located, the interior area and the frame. If the window supports resizing, said frame can be dragged with the mouse to change its size. The interior or client area (Figure 18.88) is where the controls that make up the interface itself reside and is configured through a main panel. In “Hello World!” (page 23) you have a simple example of composition and sample of a window.

- Use `window_create` to create a window.
- Use `window_panel` to assign the main panel.
- Use `window_show` to show a window.
- Use the `ekWINDOW_TITLE` flag to include the title bar.
- Use `window_title` to assign a title.

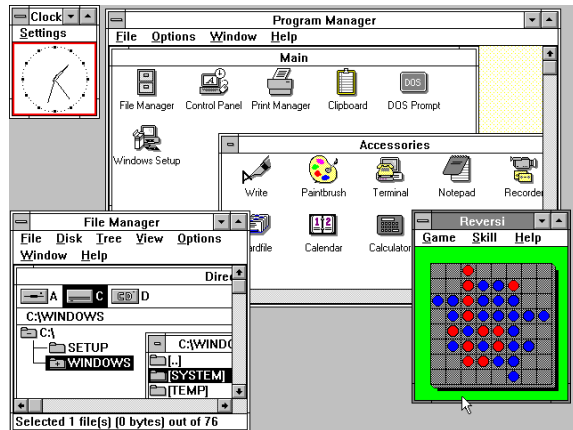

Figure 18.87: The concept of a window appears from the first desktop systems.

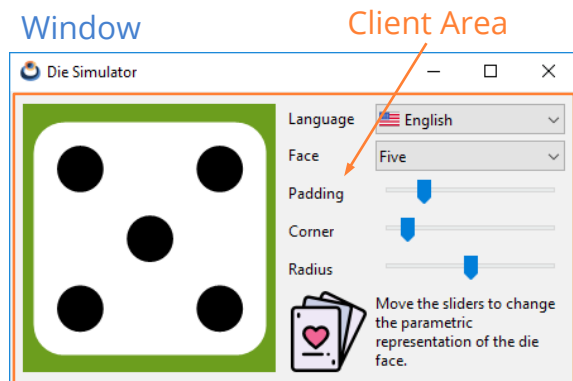

Figure 18.88: The client area is the inner part of the window.

NAppGUI does not distinguish between window, dialog box, message box, etc. The role of each window will depend on the controls it contains, its location and its behavior.

18.21.1. Window size

In principle, the size of the window is calculated automatically based on the “*Natural sizing*” (page 351) of its main panel, but it can be altered at any time.

- Use `window_size` to resize the main panel.
- Use the `ekWINDOW_MAX` flag to include the maximize button in the title bar.
- Use the `ekWINDOW_MIN` flag to include the minimize button in the title bar.
- Use the `ekWINDOW_RESIZE` flag to create a window with resizable borders.

The change in the dimensions of the client area implies a relocation and re-sizing of the interior controls. This is handled automatically through the layout objects, depending on how your “*Cell expansion*” (page 355) has been configured and will recursively propagate through all sublayouts. In “*Die*” (page 423) you have an example of resizing a window (Figure 18.89).

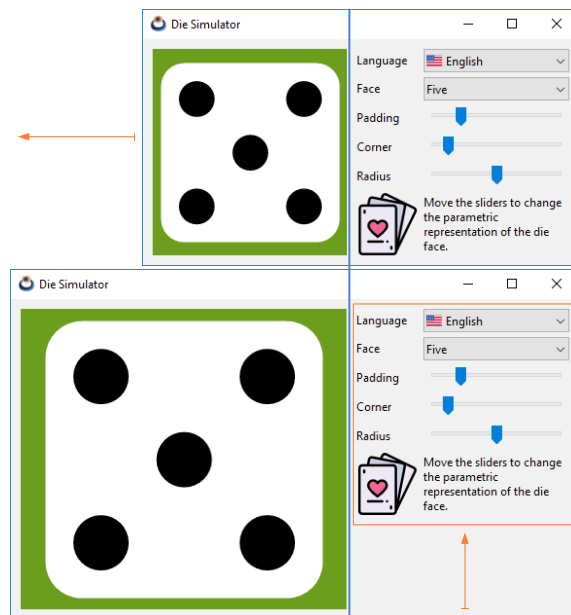

Figure 18.89: Resizing the window in the demo **Die**.

18.21.2. Closing the window

Normally a window is closed by pressing the [X] button located to the right of the title bar. But sometimes it can be useful to also close it with the [ENTER] or [ESC] keys. Closing a window implies hiding it, but not destroying it. That is, we can show an already closed window again using `window_show`. In the case that the closing is conditioned to a state of the application, such as saving a file for example, we must assign a handler through `window_OnClose` and decide there whether to close it or not.

- Use `window_hide` to hide a window.
- Use `window_destroy` to permanently destroy a window.
- Use the `ekWINDOW_CLOSE` flag to include the close button in the title bar.
- Use the `ekWINDOW_RETURN` flag to enable [ENTER] closing.
- Use the `ekWINDOW_ESC` flag to enable [ESC] closing.
- Use the `window_OnClose` flag to prevent the closing of a (Listing 18.19) window.

Listing 18.19: Prevents closing the window.

```
static void i_OnClose(App *app, Event *e)
{
    const EvWinClose *params = event_params(e, EvWinClose);
    if (can_close(app, params->origin) == FALSE)
    {
        bool_t *result = event_result(e, bool_t);
        *result = FALSE;
    }
}
...
window_OnClose(window, listener(app, i_OnClose, App));
```

By destroying a window, all its internal elements and controls are implicitly destroyed.

18.21.3. Modal windows

They are those that, when launched, block the previous window (or parent) until it is closed (Figure 18.90). Being “modal” or not is not a characteristic of the window itself, but of the way it is launched. In “*Hello Modal Window!*” (page 572) you have an example of use.

- Use `window_modal` to display a window in modal mode.
- Use `window_stop_modal` to hide it and stop the modal loop.

After calling `window_modal`, the program stops at this point, waiting for the window to close, which can be done using [X], [ENTER], [ESC] or by calling `window_stop_modal` (Listing 18.20). The value returned by this function will be:

- `ekGUI_CLOSE_ESC` (1). If the modal window was closed by pressing [ESC].
- `ekGUI_CLOSE_INTRO` (2). If the modal window was closed by pressing [ENTER].
- `ekGUI_CLOSE_BUTTON` (3). If the modal window was closed by pressing [X].
- The value indicated in `window_stop_modal`.

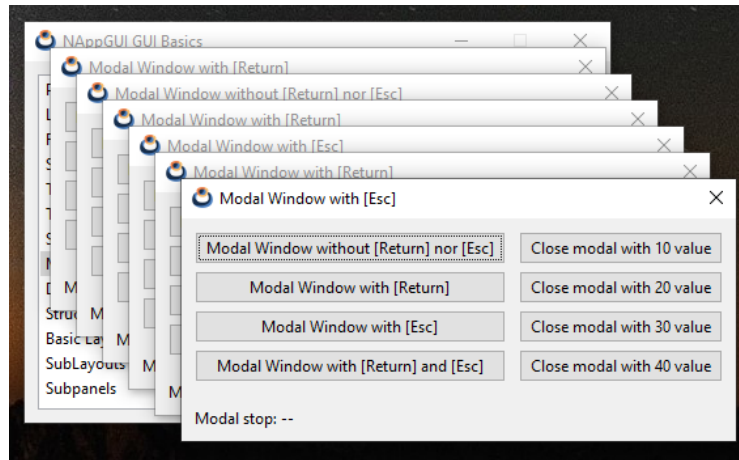

Figure 18.90: Multiple modal windows.

Listing 18.20: Using modal windows.

```

static void i_OnAcceptClick(Window *window, Event *e)
{
    window_stop_modal(window, 300);
}

Window *window = i_create_window_with_accept_button();
// The program will stop HERE until window is closed
uint32_t ret = window_modal(window);

if (ret == 1)
{
    // Closed by ESC
}
else if (ret == 2)
{
    // Closed by INTRO
}
else if (ret == 3)
{
    // Closed by [X]
}
else if (ret == 300)
{
    // Closed by window_stop_modal
}

window_destroy(&window);

```

By default, the modal window will be hidden after receiving the call to `window_stop_modal`, but it will not be destroyed as we indicated above. On certain occasions (although not

very common), we may want to relaunch the window after finishing the modal cycle without producing an unsightly “flicker” due to a new (and fast) display after closing the window.

- Use the `ekWINDOW_MODAL_NOHIDE` flag when creating the window to prevent it from being hidden after the modal loop.

18.21.4. Overlay windows

- Use `window_overlay` to launch an overlay window.

Sometimes it can be useful to display small windows on top of the main one that temporarily include additional controls. It is a similar case to modal windows, with the difference that the “parent” window will not be deactivated and will continue to receive events from the operating system, while the secondary one remains visible. They usually do not include a border or title bar. In “*Hello Overlay Window!*” (page 577) you have the source code for (Figure 18.91).

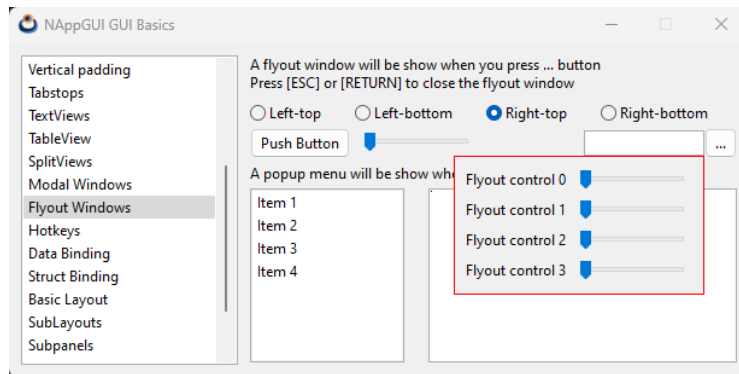

Figure 18.91: Overlay window with additional controls.

- Use `window_control_frame` to get the window coordinates of an inner control.
- Use `window_client_to_screen` to transform window coordinates to screen coordinates.

It is common that we have to position the overlay windows taking as reference some control inside the window, but the origin of the window must be provided in screen coordinates. (Listing 18.21) shows how to correctly perform the coordinate transformation of (Figure 18.91).

Listing 18.21: Alignment of the overlay window with respect to an Editbox.

```
static void i_OnIdleLaunch(FlyOut *flyout, Event *e)
{
    /* Edit control bounds in window coordinates */
```

```

R2Df frame = window_control_frame(flyout->parent, flyout->edit);
/* Top-Left edit control in screen coordinates */
V2Df pos = window_client_to_screen(flyout->parent, frame.pos);
/* Flyout window size */
S2Df size = window_get_size(flyout->flywin);

switch (flyout->align) {
case 0:
    pos.y += frame.size.height;
    break;
case 1:
    pos.y -= size.height;
    break;
case 2:
    pos.x -= size.width - frame.size.width;
    pos.y += frame.size.height;
    break;
case 3:
    pos.x -= size.width - frame.size.width;
    pos.y -= size.height;
    break;
}

/* Position in screen coordinates */
window_origin(flyout->flywin, pos);
window_overlay(flyout->flywin, flyout->parent);
unref(e);
}

```

If we click on the parent window, the secondary window will be deactivated and hidden automatically. We will have to call `window_overlay` again to show it. If we want to avoid closing due to deactivation, we must consider the value `ekGUI_CLOSE_DEACT` in `window_OnClose`. Of course, we can also include the `ekGUI_CLOSE_ESC` and `ekGUI_CLOSE_INTRO` flags to close the window using the keyboard.

18.21.5. Keyboard focus

Certain windows, such as dialog boxes, make extensive use of the keyboard. It is even possible that the user will have to manage data entry without using the mouse. This is why we have to be very clear about how the different elements behave when keystrokes. The **only control** that receives key events within a given window is called **keyboard focus**. Typically this control appears with the highlighted border (Figure 18.92).

- Use `window_get_focus` to get the keyboard focus control.

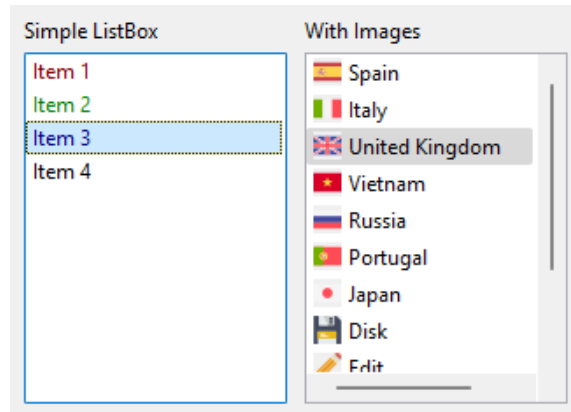

Figure 18.92: The control on the left has keyboard focus.

18.21.6. Focus change

The keyboard focus is automatically assigned to the first control in the *tab-list* when the window is activated and can be changed in different ways:

- Using `[TAB]` or `[SHIFT]+[TAB]` we will move through the controls included in the *tab-list*, as we already saw in “*Tabstops*” (page 359).
- Clicking on the control to which we want to connect the keyboard.
- Using `window_focus`, which will set it to the desired control via code.
- Using `window_next_tabstop` which is equivalent to pressing `[TAB]`. In “*Hello IP-Input!*” (page 618) you have several `Edit` that move to the next control when exactly three numbers are entered.
- Using `window_previous_tabstop` which is equivalent to pressing `[SHIFT]+[TAB]`.

These functions will return a `gui_focus_t` to indicate whether the focus change was successful or not.

18.21.7. Focus protocol

Changing focus between controls is not direct, but rather follows a protocol (Figure 18.93). Generally we don’t have to worry about this, since each control has a default behavior when releasing or accepting focus. The points to keep in mind are the following:

- `Edit` controls can retain focus in response to an `OnChange` event, as we saw in “*Validate texts*” (page 319).
- Custom views allow you to make a decision at runtime using the `OnResignFocus` and `OnAcceptFocus` events, as we also saw in “*Using the keyboard*” (page 332). By default, they will accept both cases.

- Use `window_focus_info` within `edit_OnChange` or `view_OnResignFocus` to obtain additional information about the focus change operation.

For example, if we press [TAB] on an `Edit`, the `OnChange` event will be raised, which may return `FALSE` as a reply. In this case, the keyboard focus will remain on that `Edit` and will not jump to the next control.

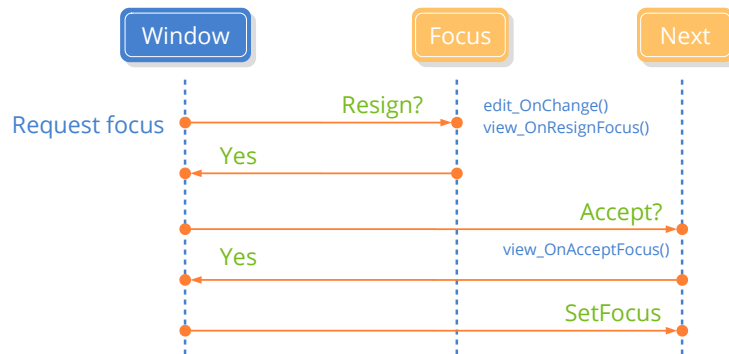

Figure 18.93: Protocol for changing the focus.

18.21.8. Tablist without cycles

Returning to navigation using the [TAB] key, the usual thing will be for the tabstops to work **cyclically** (by default). That is, if the last control in the *tab-list* has focus and we press [TAB], the focus will go back to the first control in the *tab-list*. It is possible to disable this behavior, leaving the focus fixed on the last control even if we repeatedly press the [TAB] key. Likewise, the focus will remain fixed on the first control even if we press [SHIFT]+[TAB].

- Use `window_cycle_tabstop` to enable/disable cycling tabstops.

18.21.9. Default button

The default button is the one that appears highlighted within the window and that will receive an `OnClick` event every time the [RETURN] key is pressed, regardless of which control have keyboard focus. In principle, there is no button by default, it must be indicated explicitly in the window.

- Use `window_defbutton` to set the default button.

18.21.10. Keyboard shortcuts

As we have already indicated, the keyboard focus will be fixed on some control inside the window, be it a `Edit`, `Button`, `View`, etc. But it is possible that we want to define global actions associated with a specific key.

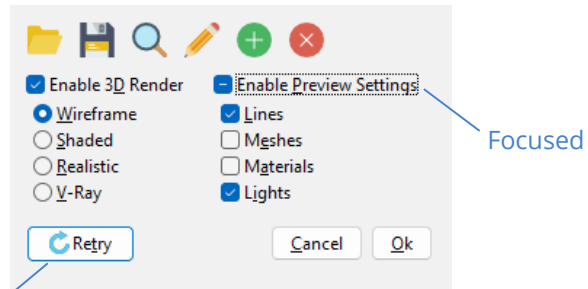

Figure 18.94: Default button.

- Use `window_hotkey` to assign an action to a key.
- Use `window_clear_hotkeys` to remove all shortcuts associated with the window.

The *hotkeys* will have **priority over the keyboard focus** (Figure 18.95). That is, if we have an action linked to the [F9] key, the window will capture the `ekGUI_EVENT_KEYDOWN` event (F9) and this will not reach the control that currently has the keyboard focus.

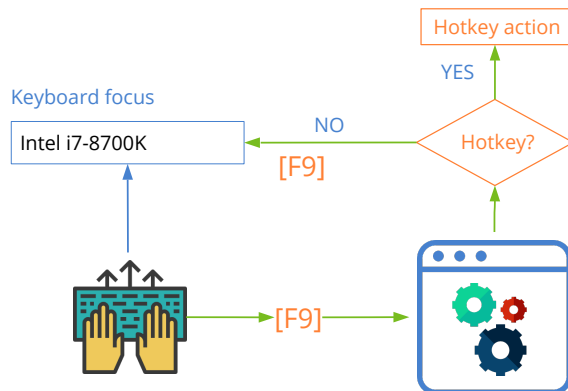

Figure 18.95: Processing a keyboard shortcut.

To conclude, we summarize all the points to take into account when carrying out correct keyboard management.

- Close the window with [RETURN] or [ESC].
- Correctly manage the *tab-list* and keyboard focus.
- Define a default button, which is activated when pressing [RETURN].
- Define the appropriate keyboard shortcuts.

18.22. GUI Data binding

By **GUI Data Binding** we mean automatic mapping between program variables and user interface controls (Figure 18.96). In this way both will be synchronized without the programmer having to do any extra work such as capturing events, assigning values, checking ranges, etc. In *“Hello Gui Binding!”* (page 583) you have the complete source code of the example that we will show below.

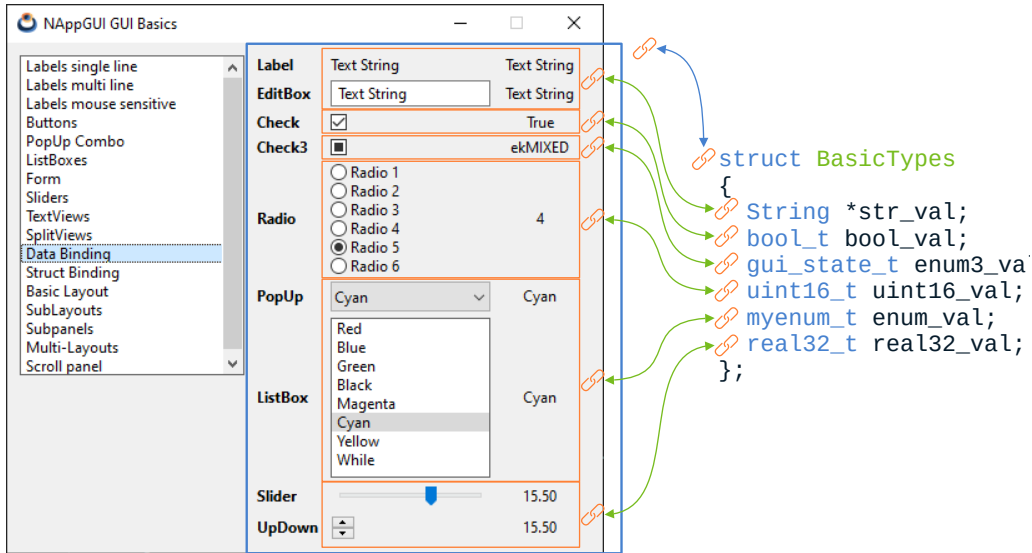

Figure 18.96: Automatic data synchronization with the user interface.

18.22.1. Basic type binding

We start from a data structure composed of several basic types fields (Listing 18.22), where no other structures or objects are nested.

Listing 18.22: Simple data model.

```
typedef struct _basictypes_t BasicTypes;

typedef enum _myenum_t
{
    ekRED,
    ekBLUE,
    ekGREEN,
    ekBLACK,
    ekMAGENTA,
    ekCYAN,
    ekYELLOW,
    ekWHITE
} myenum_t;
```

```

struct _basictypes_t
{
    bool_t bool_val;
    uint16_t uint16_val;
    real32_t real32_val;
    myenum_t enum_val;
    gui_state_t enum3_val;
    String *str_val;
};

```

The first thing we must do is register the fields of the structure with `dbind` (Listing 18.23):

Listing 18.23: Register in `dbind` de los campos de la estructura.

```

dbind_enum(gui_state_t, ekGUI_OFF, "");
dbind_enum(gui_state_t, ekGUI_ON, "");
dbind_enum(gui_state_t, ekGUI_MIXED, "");
dbind_enum(myenum_t, ekRED, "Red");
dbind_enum(myenum_t, ekBLUE, "Blue");
dbind_enum(myenum_t, ekGREEN, "Green");
dbind_enum(myenum_t, ekBLACK, "Black");
dbind_enum(myenum_t, ekMAGENTA, "Magenta");
dbind_enum(myenum_t, ekCYAN, "Cyan");
dbind_enum(myenum_t, ekYELLOW, "Yellow");
dbind_enum(myenum_t, ekWHITE, "While");
dbind(BasicTypes, bool_t, bool_val);
dbind(BasicTypes, uint16_t, uint16_val);
dbind(BasicTypes, real32_t, real32_val);
dbind(BasicTypes, gui_state_t, enum3_val);
dbind(BasicTypes, myenum_t, enum_val);
dbind(BasicTypes, String*, str_val);
dbind_range(BasicTypes, real32_t, real32_val, -50, 50);
dbind_increment(BasicTypes, real32_t, real32_val, 5);

```

DBind is a registry, within the application, that allows automating certain operations on the data, as well as establishing ranges, precisions or aliases. Its use goes beyond graphical user interfaces. More information in “Data binding” (page 233).

On the other hand, we build a “Layout” (page 350) that hosts the different controls of the user interface (Listing 18.24):

Listing 18.24: Interface controls organized in a layout (Figure 18.96).

```

static Layout *i_layout(void)
{
    Layout *layout = layout_create(3, 9);
    Label *label = label_create();

```

```

Edit *edit = edit_create();
Button *check = button_check();
Button *check3 = button_check3();
Layout *radios = i_radio_layout();
PopUp *popup = popup_create();
ListBox *listbox = listbox_create();
Slider *slider = slider_create();
UpDown *updown = updown_create();
layout_label(layout, label, 1, 0);
layout_edit(layout, edit, 1, 1);
layout_button(layout, check, 1, 2);
layout_button(layout, check3, 1, 3);
layout_layout(layout, radios, 1, 4);
layout_popup(layout, popup, 1, 5);
layout_listbox(layout, listbox, 1, 6);
layout_slider(layout, slider, 1, 7);
layout_updown(layout, updown, 1, 8);
layout_halign(layout, 1, 0, ekJUSTIFY);
layout_halign(layout, 1, 8, ekLEFT);
return layout;
}

```

Now we will link the cells of our layout with the fields of the structure (Listing 18.25). Pay attention that we have **not yet created any object** of type `BasicTypes`. Therefore, it is a semantic link where memory positions do not intervene, but the displacements (offset) of the fields within the data structure.

- Use `cell_dbind` to bind a field to an individual cell.
- Use `layout_dbind` to link a structure with a layout.
- Use `layout_cell` to get a cell from a Layout.

Listing 18.25: Binding variables with cells in the layout.

```

cell_dbind(layout_cell(layout, 1, 0), BasicTypes, String*, str_val);
cell_dbind(layout_cell(layout, 1, 1), BasicTypes, String*, str_val);
cell_dbind(layout_cell(layout, 1, 2), BasicTypes, bool_t, bool_val);
cell_dbind(layout_cell(layout, 1, 3), BasicTypes, gui_state_t, enum3_val);
cell_dbind(layout_cell(layout, 1, 4), BasicTypes, uint16_t, uint16_val);
cell_dbind(layout_cell(layout, 1, 5), BasicTypes, myenum_t, enum_val);
cell_dbind(layout_cell(layout, 1, 6), BasicTypes, myenum_t, enum_val);
cell_dbind(layout_cell(layout, 1, 7), BasicTypes, real32_t, real32_val);
cell_dbind(layout_cell(layout, 1, 8), BasicTypes, real32_t, real32_val);
layout_dbind(layout, NULL, BasicTypes);

```

When linking a data structure with `layout_dbind` we must bear in mind that the cells of said layout **can only be associated with fields of the same structure**. Otherwise, we will get a run-time error, due to the data inconsistency that would occur. In other words, we cannot mix structures within the same layout.

Isolated variables cannot be used in Data Binding. They must all belong to a struct since, internally, the relations (Layout → Struct) and (Cell → Field or Variable) are established.

Finally, we will associate an object of type `BasicTypes` with the layout created previously (Listing 18.26).

- Use `layout_dbind_obj` to bind an object to the user interface.

Listing 18.26: Binding an object to the interface.

```
BasicTypes *data = heap_new(BasicTypes);
data->bool_val = TRUE;
data->uint16_val = 4;
data->real32_val = 15.5f;
data->enum3_val = ekGUI_MIXED;
data->enum_val = ekCYAN;
data->str_val = str_c("Text String");
layout_dbind_obj(layout, data, BasicTypes);
```

- You can change the object being “edited” at any time, with a new call to `layout_dbind_obj`.
- If we pass `NULL` to `layout_dbind_obj` the cells linked to fields of the structure will be disabled.

18.22.2. Limits and ranges

Keep in mind that the expressiveness of controls will, generally, be well below the range of values supported by data types (Listing 18.27). For example, if we link a `uint16_t` with a `RadioGroup` the latter will only support values between 0 and `n-1`, where `n` is the total number of radios. The controls are set up to handle out-of-range values as consistently as possible, but this does not exempt the programmer from getting it right. In (Table 18.5) you have a summary of the data types and ranges supported by the standard controls.

Listing 18.27: Value not representable in the `RadioGroup` of (Figure 18.96).

```
data->uint16_val = 1678;
cell_dbind(layout_cell(layout, 1, 4), BasicTypes, uint16_t, uint16_val);
```

Control	Data Type
“Label” (page 312)	String, Number, Enum
“Edit” (page 319)	String, Number

Control	Data Type
“Button” (page 316) (CheckBox)	Boolean
“Button” (page 316) (CheckBox3)	Enum (3 values), Integer (0,1,2)
“RadioGroup” (page 317)	Enum, Integer (0,1,2...n-1)
“PopUp” (page 319)	Enum, Integer (0,1,2...n-1)
“ListBox” (page 324)	Enum, Integer (0,1,2...n-1)
“Slider” (page 326)	Number (min..max)
“UpDown” (page 324)	Enum, Number

Table 18.5: Data types and ranges of GUI controls.

18.22.3. Nested structures

Let’s now look at a somewhat more complicated data model, which includes nested structures in addition to the basic types (Figure 18.97). In this case we have a structure called `StructTypes` that contains instances of another structure called `Vector` (Listing 18.28). You can find the complete source code for this second example at “*Hello Struct Binding!*” (page 587).

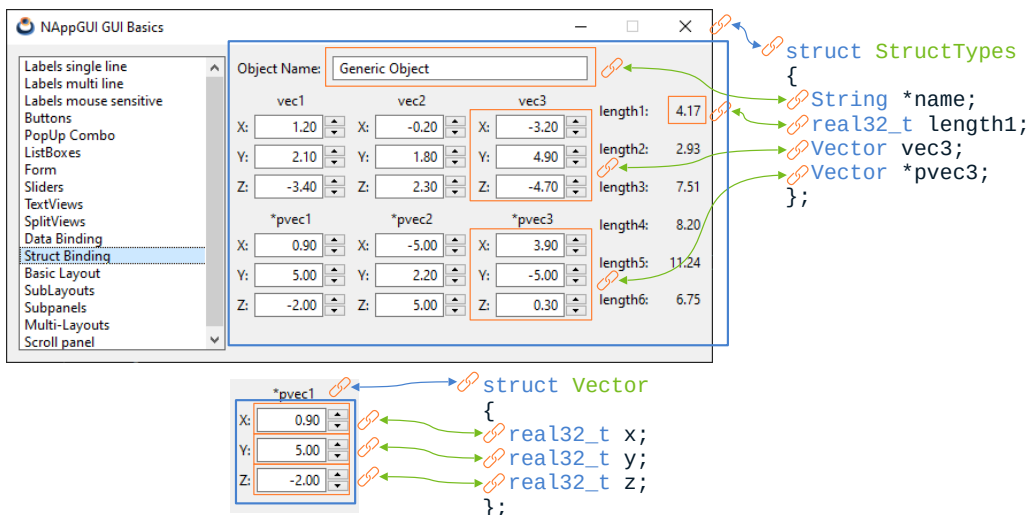

Figure 18.97: Data binding with substructures.

Listing 18.28: Data model with nested structures and registry in dbind.

```

typedef struct _vector_t Vector;
typedef struct _structtypes_t StructTypes;

```

```

struct _vector_t
{
    real32_t x;
    real32_t y;
    real32_t z;
};

struct _structtypes_t
{
    String *name;
    Vector vec1;
    Vector vec2;
    Vector vec3;
    Vector *pvec1;
    Vector *pvec2;
    Vector *pvec3;
    real32_t length1;
    real32_t length2;
    real32_t length3;
    real32_t length4;
    real32_t length5;
    real32_t length6;
};

dbind(Vector, real32_t, x);
dbind(Vector, real32_t, y);
dbind(Vector, real32_t, z);
dbind(StructTypes, String*, name);
dbind(StructTypes, Vector, vec1);
dbind(StructTypes, Vector, vec2);
dbind(StructTypes, Vector, vec3);
dbind(StructTypes, Vector*, pvec1);
dbind(StructTypes, Vector*, pvec2);
dbind(StructTypes, Vector*, pvec3);
dbind(StructTypes, real32_t, length1);
dbind(StructTypes, real32_t, length2);
dbind(StructTypes, real32_t, length3);
dbind(StructTypes, real32_t, length4);
dbind(StructTypes, real32_t, length5);
dbind(StructTypes, real32_t, length6);
dbind_range(Vector, real32_t, x, -5, 5);
dbind_range(Vector, real32_t, y, -5, 5);
dbind_range(Vector, real32_t, z, -5, 5);
dbind_increment(Vector, real32_t, x, .1f);
dbind_increment(Vector, real32_t, y, .1f);
dbind_increment(Vector, real32_t, z, .1f);

```

We started with the same methodology that we used with the first example. We create a layout and link it with the `vector` structure (Listing 18.29). This does not present problems, as it is composed exclusively of basic types `real32_t`.

Listing 18.29: Layout for editing objects of type Vector.

```

static Layout *i_vector_layout(void)
{
    Layout *layout = layout_create(3, 3);
    Label *label1 = label_create();
    Label *label2 = label_create();
    Label *label3 = label_create();
    Edit *edit1 = edit_create();
    Edit *edit2 = edit_create();
    Edit *edit3 = edit_create();
    UpDown *updown1 = updown_create();
    UpDown *updown2 = updown_create();
    UpDown *updown3 = updown_create();
    label_text(label1, "X:");
    label_text(label2, "Y:");
    label_text(label3, "Z:");
    edit_align(edit1, ekRIGHT);
    edit_align(edit2, ekRIGHT);
    edit_align(edit3, ekRIGHT);
    layout_label(layout, label1, 0, 0);
    layout_label(layout, label2, 0, 1);
    layout_label(layout, label3, 0, 2);
    layout_edit(layout, edit1, 1, 0);
    layout_edit(layout, edit2, 1, 1);
    layout_edit(layout, edit3, 1, 2);
    layout_updown(layout, updown1, 2, 0);
    layout_updown(layout, updown2, 2, 1);
    layout_updown(layout, updown3, 2, 2);
    cell_dbind(layout_cell(layout, 1, 0), Vector, real32_t, x);
    cell_dbind(layout_cell(layout, 1, 1), Vector, real32_t, y);
    cell_dbind(layout_cell(layout, 1, 2), Vector, real32_t, z);
    cell_dbind(layout_cell(layout, 2, 0), Vector, real32_t, x);
    cell_dbind(layout_cell(layout, 2, 1), Vector, real32_t, y);
    cell_dbind(layout_cell(layout, 2, 2), Vector, real32_t, z);
    layout_dbind(layout, NULL, Vector);
    return layout;
}

```

The idea now is to use this function to create “*Sub-layouts*” (page 354) and associate them to cells of a higher level layout, which can support objects of type StructTypes (Listing 18.30). Sub-layouts of type Vector are linked to the fields {Vector vec1, Vector * pvec1, ...} using `cell_dbind`, so similar to how we did it with the basic types.

Listing 18.30: Layout that supports objects of type StructTypes.

```

static Layout *i_struct_types_layout(void)
{
    Layout *layout1 = i_create_layout();
    Layout *layout2 = i_vector_layout();
}

```



```

Layout *layout3 = i_vector_layout();
Layout *layout4 = i_vector_layout();
Layout *layout5 = i_vector_layout();
Layout *layout6 = i_vector_layout();
Layout *layout7 = i_vector_layout();
Label *label1 = label_create();
Label *label2 = label_create();
Label *label3 = label_create();
layout_layout(layout1, layout2, 0, 0);
layout_layout(layout1, layout3, 1, 0);
layout_layout(layout1, layout4, 2, 0);
layout_layout(layout1, layout5, 0, 1);
layout_layout(layout1, layout6, 1, 1);
layout_layout(layout1, layout7, 2, 1);
layout_label(layout1, label1, 0, 2);
layout_label(layout1, label2, 1, 2);
layout_label(layout1, label3, 2, 2);
cell_dbind(layout_cell(layout1, 0, 0), StructTypes, Vector, vec1);
cell_dbind(layout_cell(layout1, 1, 0), StructTypes, Vector, vec2);
cell_dbind(layout_cell(layout1, 2, 0), StructTypes, Vector, vec3);
cell_dbind(layout_cell(layout1, 0, 1), StructTypes, Vector*, pvec1);
cell_dbind(layout_cell(layout1, 1, 1), StructTypes, Vector*, pvec2);
cell_dbind(layout_cell(layout1, 2, 1), StructTypes, Vector*, pvec3);
cell_dbind(layout_cell(layout1, 0, 2), StructTypes, real32_t, length1);
cell_dbind(layout_cell(layout1, 1, 2), StructTypes, real32_t, length2);
cell_dbind(layout_cell(layout1, 2, 2), StructTypes, real32_t, length3);
layout_dbind(layout1, NULL, StructTypes);
return layout1;
}

```

And finally, we only have to link objects of type `StructTypes` with the main layout (Listing 18.31). `DBind` will detect sub-layouts of type `Vector` and will automatically associate the corresponding sub-objects (by value or by pointer). Therefore, only one call to `layout_dbind_obj` will be necessary (the one of the main object).

Listing 18.31: Associate object and sub-objects to a layout.

```

StructTypes *data = heap_new(StructTypes);
Layout *layout = i_struct_types_layout();
data->name = str_c("Generic Object");
data->pvec1 = heap_new(Vector);
data->pvec2 = heap_new(Vector);
data->pvec3 = heap_new(Vector);
data->vec1 = i_vec_init(1.2f, 2.1f, -3.4f);
data->vec2 = i_vec_init(-0.2f, 1.8f, 2.3f);
data->vec3 = i_vec_init(-3.2f, 4.9f, -4.7f);
*data->pvec1 = i_vec_init(0.9f, 7.9f, -2.0f);
*data->pvec2 = i_vec_init(-6.9f, 2.2f, 8.6f);
*data->pvec3 = i_vec_init(3.9f, -5.5f, 0.3f);
data->length1 = i_vec_length(&data->vec1);
data->length2 = i_vec_length(&data->vec2);

```

```

data->length3 = i_vec_length(&data->vec3);
data->length4 = i_vec_length(data->pvec1);
data->length5 = i_vec_length(data->pvec2);
data->length6 = i_vec_length(data->pvec3);

layout_dbind_obj(layout, data, StructTypes);

```

In summary:

- For each sub-structure we create a sub-layout, linking the fields locally.
- The cells that contain these sub-layouts will be linked to the main structure.
- We assign the object to edit to the main layout.

18.22.4. Notifications and calculated fields

If we apply what was seen in the previous sections, the synchronization between data and interface is carried out in these two situations:

- When the program calls `layout_dbind_obj`. At that time the interface will reflect the state of the object.
- When the user manipulates any control, then the object's value will be updated.

However, it is possible that the program must be notified when the user modifies the object, in order to carry out certain actions (update drawings, save data in files, launch calculus algorithms, etc.). This will be resolved by events, as reflected in (Figure 18.98). On the other hand, the program can alter the values of certain fields of the object and must notify the changes to the interface (layout) so that it remains updated.

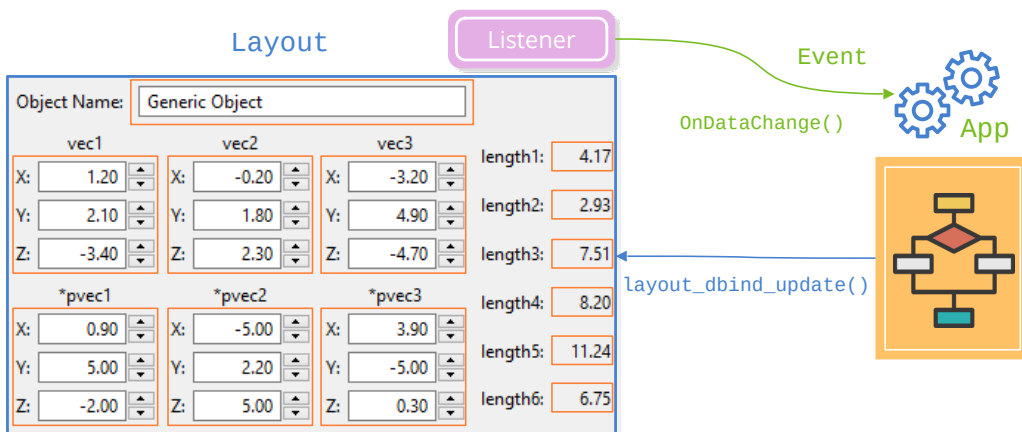

Figure 18.98: Notification of value change to main program.

- Use `layout_dbind` to include a `listener` that notifies changes to the application.

- Use `evbind_object` to obtain, within the callback, the object that is being edited.
- Use `event_sender` to obtain, within the callback, the layout that sent the notification.
- Use `evbind_modify` to know, inside the callback, if a field of the object has changed or not.
- Use `layout_dbind_update` to notify the layout that a field of the object has been modified by the application.

All of this can be seen in (Listing 18.32). Every time the user changes any `StructTypes` value, a notification of type `ekGUI_EVENT_OBJCHANGE` will be launched that will check if the `vec1` field has changed. If so, its length will be recalculated and the GUI controls associated with that variable will be updated.

Listing 18.32: Notification of object values modification.

```
static void i_OnDataChange(App *app, Event *e)
{
    StructTypes *data = evbind_object(e, StructTypes);
    Layout *layout = event_sender(e, Layout);
    cassert(event_type(e) == ekGUI_EVENT_OBJCHANGE);

    if (evbind_modify(e, StructTypes, Vector, vec1) == TRUE)
    {
        app_update_drawing(app);
        data->length1 = i_vec_length(&data->vec1);
        layout_dbind_update(layout, StructTypes, real32_t, length1);
    }
}

layout_dbind(layout, listener(app, i_OnDataChange, App), StructTypes);
```

If, for some reason, the modified value is not allowed by the application, it can be reverted by returning `FALSE` as a result of the event (Listing 18.33).

Listing 18.33: Canceling changes made by the user.

```
static void i_OnDataChange(App *app, Event *e)
{
    StructTypes *data = evbind_object(e, StructTypes);
    Layout *layout = event_sender(e, Layout);

    if (evbind_modify(e, StructTypes, Vector, vec1) == TRUE)
    {
        real32_t length = i_vec_length(&data->vec1);
        if (length < 5.f)
        {
            app_update_drawing(app);
            data->length1 = length;
        }
    }
}
```

```

        layout_dbind_update(layout, StructTypes, real32_t, length1);
    }
    else
    {
        // This will REVERT the changes in 'vec1' variable
        bool_t *res = event_result(e, bool_t);
        *res = FALSE;
    }
}
}

```

18.23. Menu

A **Menu** is a type of control that integrates a series of options, also called items or **MenuItems**. Each of them consists of a short text, optionally an icon and optionally also a keyboard shortcut, such as the classic `Ctrl+C/Ctrl+V` for copy and paste. Additionally, an item can host a submenu, forming a hierarchy with different levels of depth. In “*Products*” (page 465) you have an example application that uses menus.

- Use `menu_create` to create a menu.
- Use `menu_destroy` to destroy a menu.
- Use `menu_item` to add an option.
- Use `menu_launch` to launch a *popup* menu.
- Use `osapp_menubar` to set the application menu bar.

We must explicitly destroy any menu that we create in the application, just as happens with windows.

By destroying a menu, all its elements are implicitly destroyed.

Generally, we have two ways to launch or show menu. On the one hand, the menu bars (Figure 18.99), which are anchored to a window, although there are operating systems (such as macOS) that display the menu bar at the top of the screen. On the other hand, the *popup* or contextual menus (Figure 18.100) that are displayed at any time during execution as an overlaid window, normally when you right-click on some element of the interface.

The concept of the menu, like that of the window, exists from the origin of the graphic interfaces. The first computer to incorporate them was the Xerox Alto that appeared in 1973 and its commercial successor the Xerox Star. Concepts still very alive today such as: Menu, Window, Icon, Desk, or Mouse were already present on these computers that served

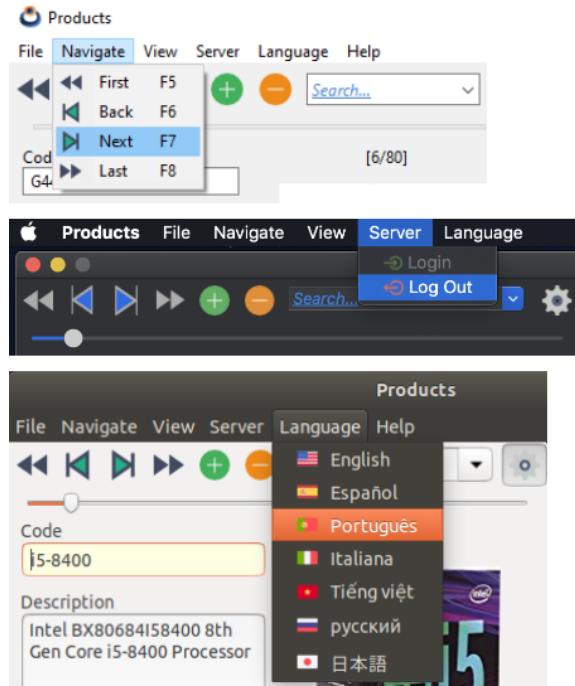

Figure 18.99: Menu bar in Windows, macOS and Linux.

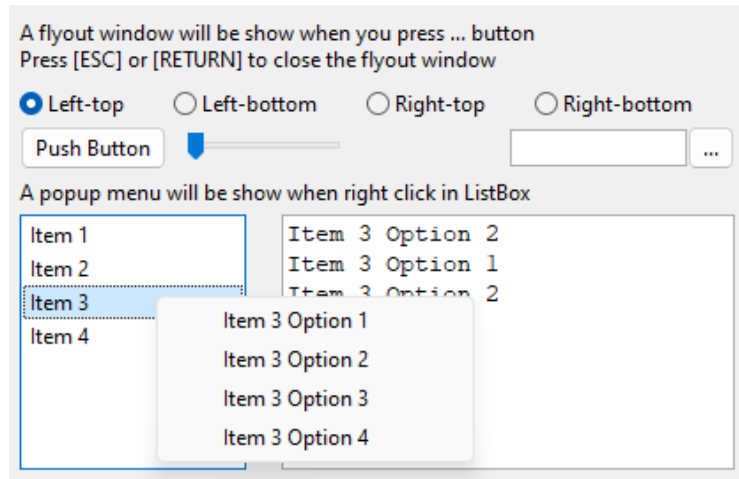

Figure 18.100: Context menu launched at runtime.

as inspiration to Steve Jobs in the creation of Apple Lisa (Figure 18.101), predecessor of Machintosh and inspirer of Microsoft Windows.

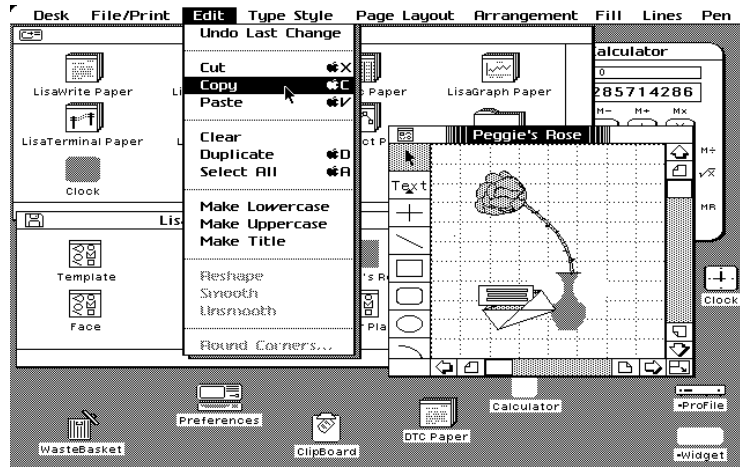

Figure 18.101: The Apple Lisa was one of the first systems to incorporate menus as part of the graphical interface.

18.24. MenuItem

Represents an option within a “Menu” (page 387). They will always have an associated action that will be executed when activated.

- Use `menuItem_create` to create an item.
- Use `menuItem_text` to assign a text.
- Use `menuItem_image` to assign an icon.

18.25. Common dialogs

Common dialogs are default windows provided by the operating system to perform daily tasks such as: Open files (Figure 18.102), select colors, fonts, etc. Its use is doubly beneficial. On the one hand we avoid programming them as part of the application and, on the other, we take advantage of the user’s previous knowledge since they will surely have been used in other programs.

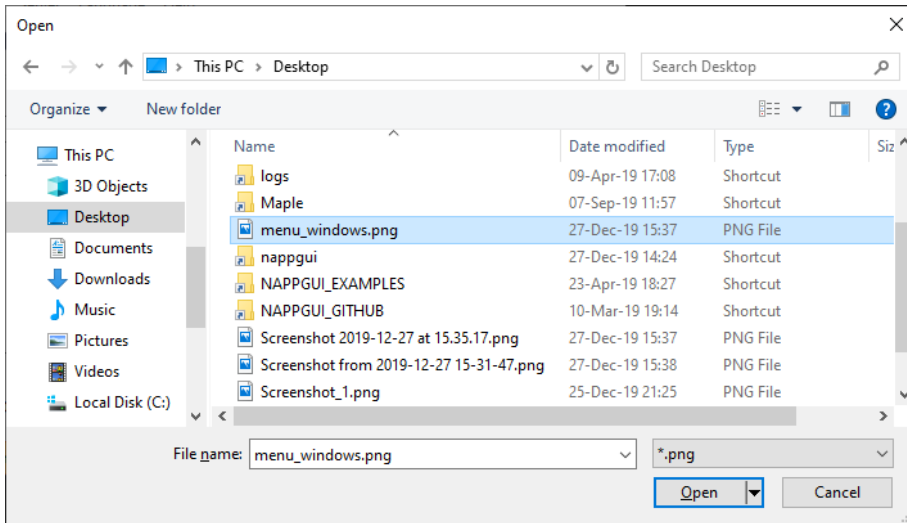

Figure 18.102: File explorer in Windows.

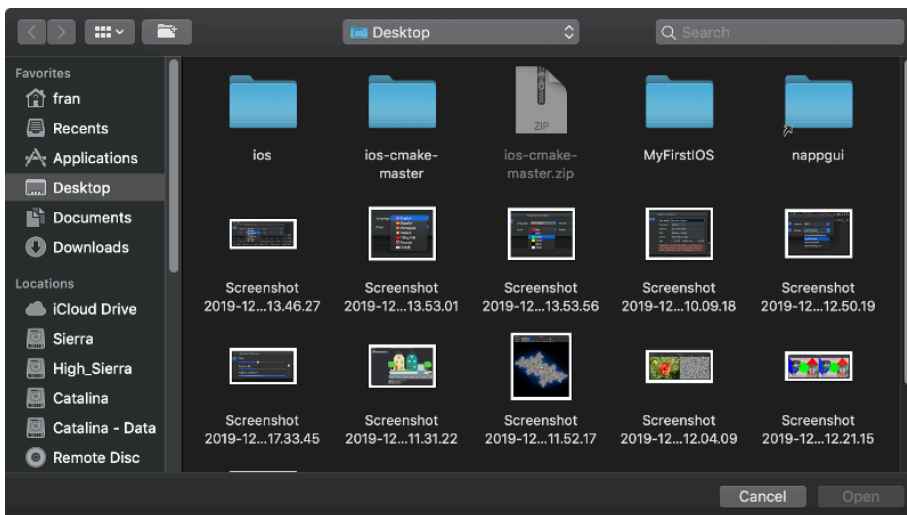

Figure 18.103: File explorer in macOS.

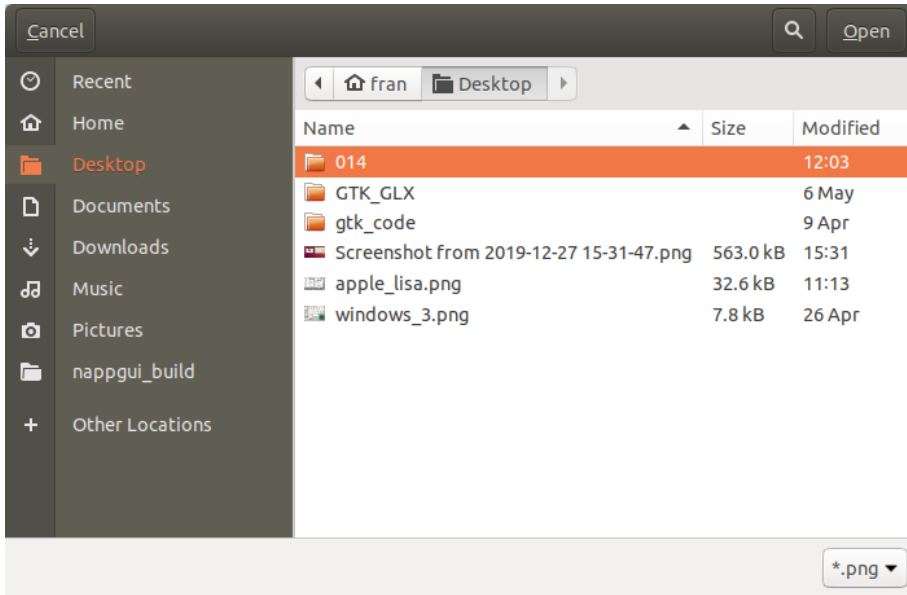

Figure 18.104: File explorer in Linux.

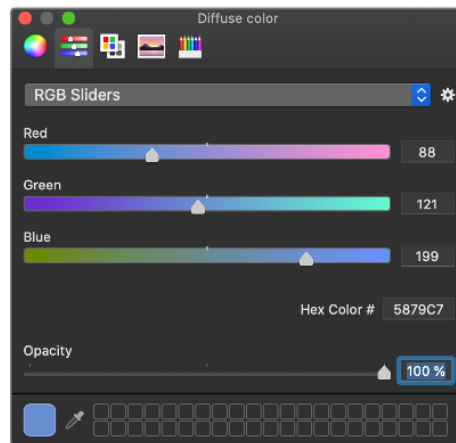

Figure 18.105: Color selection in macOS.

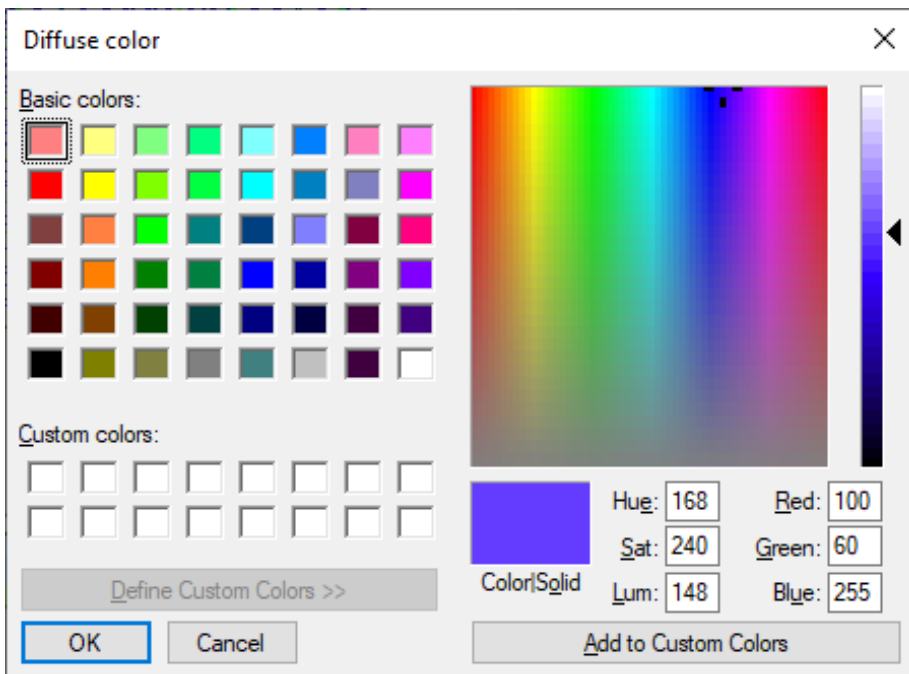

Figure 18.106: Color selection in Windows.

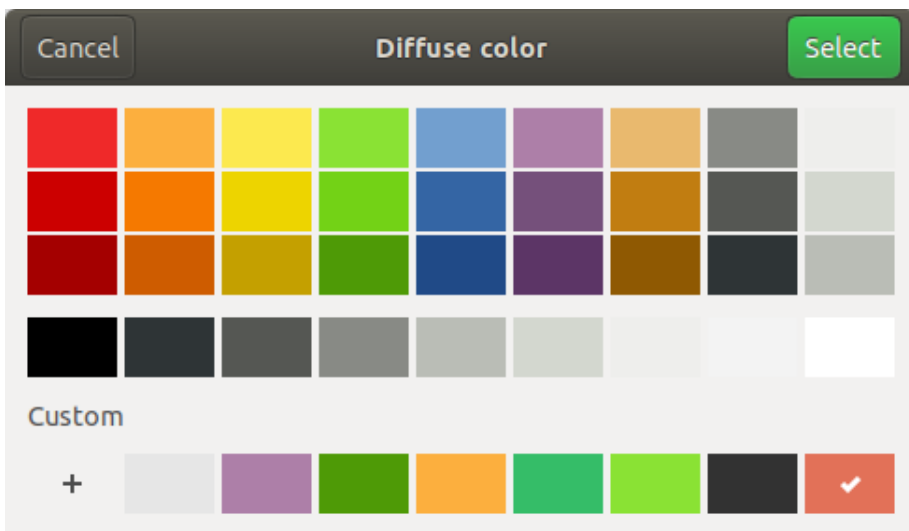

Figure 18.107: Color selection in Linux.

OSApp library

19.1	OSApp	393
19.2	main() and osmain()	393
19.3	Synchronous applications	397
19.4	Multi-threaded tasks	398

19.1. OSApp

The *OSApp* library starts and manages the **message cycle** of a desktop application (Figure 19.1). Although the **Gui** library could be integrated into existing applications through a *plugin*, if we want to create an application from scratch, we will need to manage the events that the operating system sends to the program.

- Use `osmain` to start a desktop application.
- Use `osapp_finish` to end a desktop application.

19.2. main() and osmain()

The classic `main` function is the starting point of any C/C++ command line program (Figure 19.2). Its operation does not involve any difficulty and can be summarized in:

- ① The operating system loads the program into memory and calls the function `main()` to start its execution.
- ② The sentences are executed sequentially and in the order in which they are written. This order can be altered by means of control sentences (`for`, `if`, `switch`, etc.) or function calls.

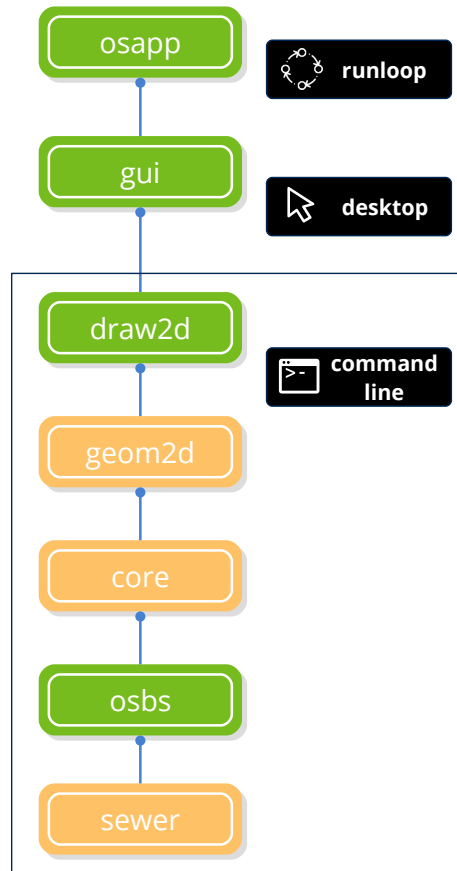

Figure 19.1: OSApp dependencies. See “NAppGUI API” (page 151).

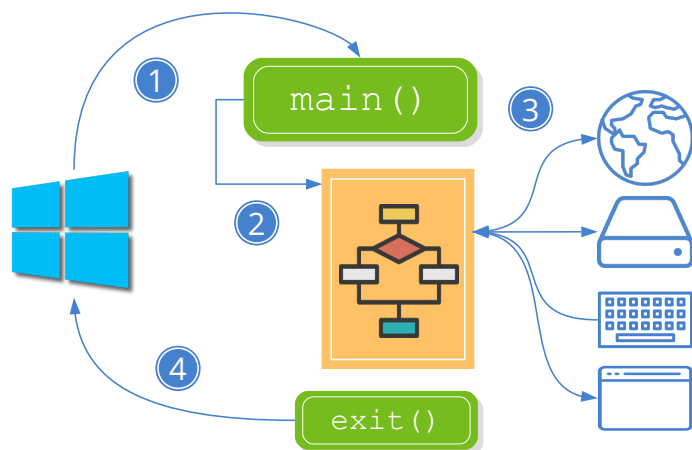

Figure 19.2: Running a console C application.

- ③ If input/output is necessary, the program will wait for the communication to end and continue with the execution.

- ④ When the end of the function is reached `main()` or an `exit()` sentence is executed, the program will end and the operating system will download it from memory.

However, in desktop applications (event driven), the execution cycle is a bit more complicated. In essence, the program is continuously executing a loop waiting for the user to perform some action (Figure 19.3) (Listing 19.1). In “Hello World!” (page 23) you have a simple example:

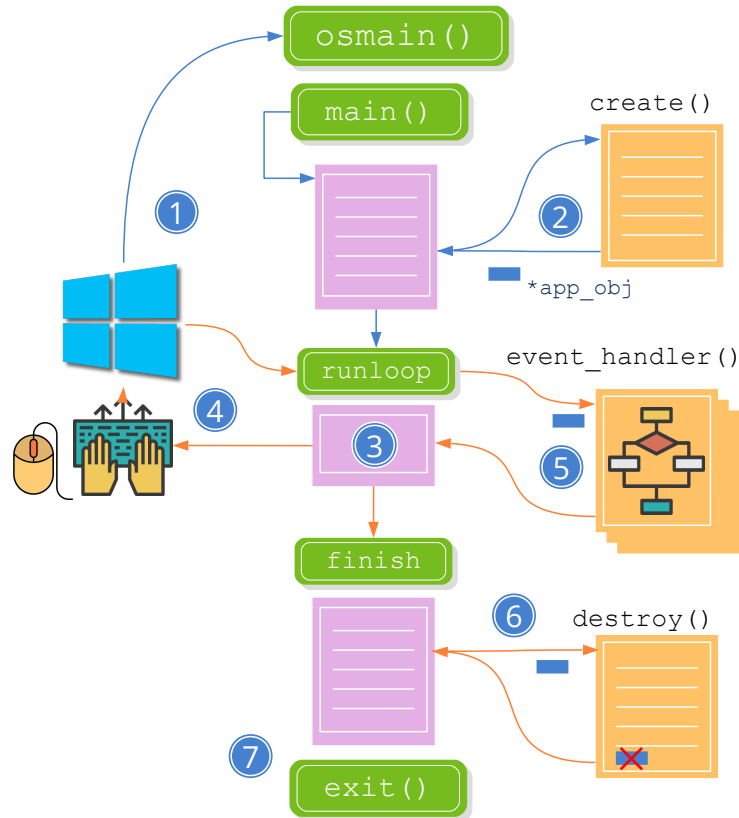

Figure 19.3: Running a desktop C application.

- ① The operating system loads the program into memory and calls the `main()` function. Now it is encapsulated inside the `osmain` macro which initiates certain structures necessary for event capture and management.
- ② At some point in this initial process, the application constructor will be called (the first parameter of `osmain()`) that the main object should create. Since the program is continuously returning control to the operating system, the state of the data and windows will be maintained in this object.

- ③ Once initialized, the application will enter a loop known as a **message cycle** (Figure 19.4), while waiting for the user to perform some action on the program interface.

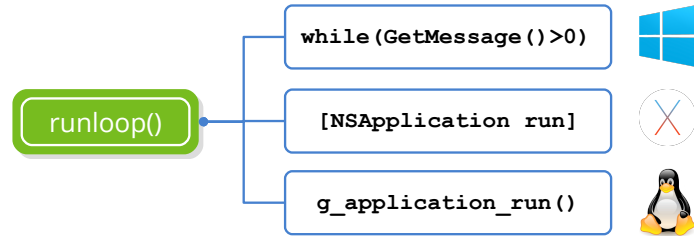

Figure 19.4: Message cycle implementation.

- ④ When this occurs, the operating system will capture the event and send it to the application.
- ⑤ If the application has defined a handle for that event, it will be invoked and the response code will be executed. An application can receive hundreds of messages but will only respond to those it deems necessary, ignoring the rest.
- ⑥ There is a special **exit** event that is generated by calling `osapp_finish`. When this happens, `osmain()` start freeing up resources and preparing a clean exit. At some point the destructor of the application will be called (second parameter of `osmain()`) to do its part of the job, closing possible open files and destroying the main object.
- ⑦ The operating system unload the application from memory.
- The pink blocks are platform dependent and are implemented within NAppGUI.
- The orange blocks are multiplatform (fully portable) and are implemented within the application.

Listing 19.1: Elementary skeleton of a desktop application.

```

typedef struct _app_t App;
struct _app_t
{
    // Program data
    Window *window;
};

static App* i_create(void)
{
    App *app = heap_new(App);
    // Init program data, GUI and Event handlers
    app->window = ...
    return app;
}
  
```

```

static void i_destroy(App *app)
{
    // Destroy program data
    window_destroy(&(*app)->window);
    heap_delete(app, App);
}

osmain(i_create, i_destroy, "", App);

```

19.3. Synchronous applications

Certain types of applications including video games, media players or simulators, need to be updated at regular intervals, whether or not the user intervenes (Figure 19.5) (Listing 19.2). For these cases we will need a variant of `osmain`, which accepts an update function and a time interval. In “*Bricks*” (page 439) you have an example.

- Use `osmain_sync` to start a synchronous application.

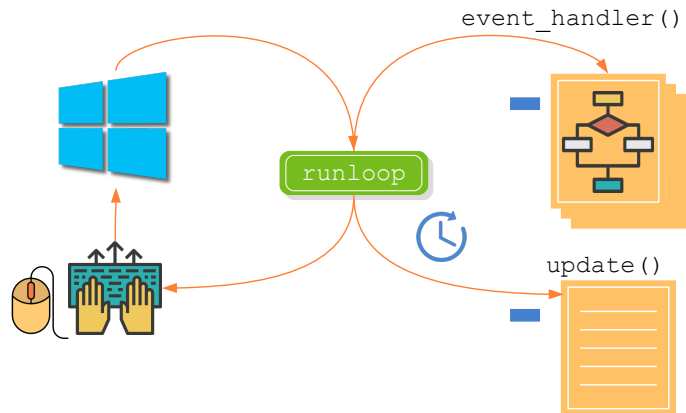

Figure 19.5: Events in synchronous applications.

Listing 19.2: Elemental skeleton of a synchronous application.

```

typedef struct _app_t App;
struct _app_t
{
    // Program data
    Window *window;
};

static App* i_create(void)
{
    App *app = heap_new(App);
    // Init program data, GUI and Event handlers
    app->window = ...
    return app;
}

```

```

static void i_update(App *app, const real64_t prtime, const real64_t ctime
↪ )
{
    // Update program state every 40ms
}

static void i_destroy(App *app)
{
    // Destroy program data
    window_destroy(&(*app)->window);
    heap_delete(app, App);
}

osmain_sync(0.04, i_create, i_destroy, i_update, "", App);

```

19.4. Multi-threaded tasks

Both synchronous and asynchronous applications execute the message cycle on a single CPU thread. This means that if, in response to an event, a relatively slow task must be executed, the application will be “frozen” until it is finished (Figure 19.6)(a). This will produce an unwanted effect since the program will not respond for a few seconds, giving the impression that it has been blocked. The solution is to launch a task in parallel (Figure 19.6)(b) (Listing 19.3), quickly release the thread that manages the GUI. In “*Multi-threaded login*” (page 480) you have an example of the use of tasks.

- Use `osapp_task` to launch a new task in a parallel thread.

Listing 19.3: New task in a parallel thread.

```

// Runs in new thread
static uint32_t i_task_main(TaskData *data)
{
    // Do the task work here!
}

// Runs in GUI thread
static void i_task_update(TaskData *data)
{
    // Update the GUI here!
}

// Runs in GUI thread
static void i_task_end(TaskData *data, const uint32_t rvalue)
{
    // Finish task code here!
}

osapp_task(tdata, .04, i_task_main, i_task_update, i_task_end, TaskData);

```

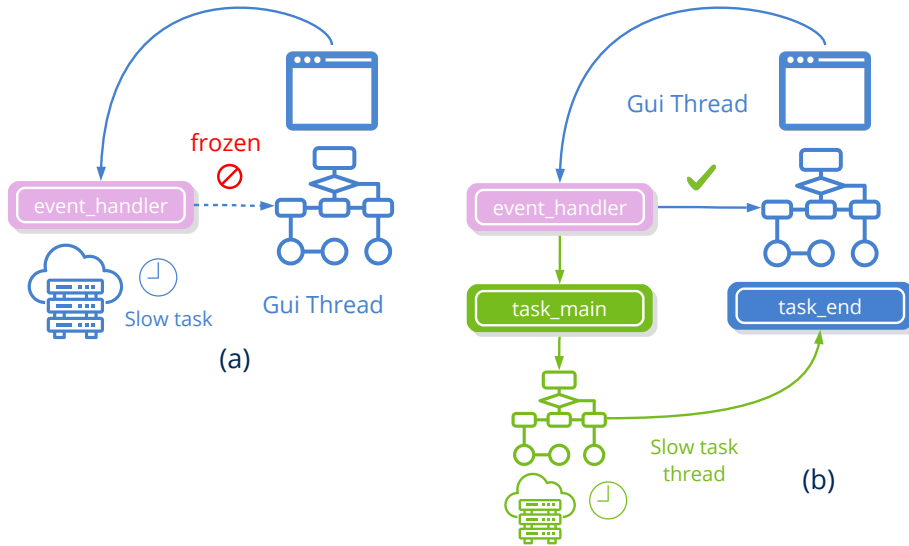

Figure 19.6: (a) Interface lock due to a slow function. (b) Slow function in a parallel thread.

The new thread will begin its execution in `task_main`. This function **should not** access the interface elements, just perform calculations or input/output tasks. If it is necessary to update the GUI for the duration of the task (increasing a progress bar or similar), it must be done in `task_update`, indicating in `uptime` the update interval. The new thread will end when it returns from `task_main`, moment to be called `task_end` in the main thread. Obviously, if both threads access shared variables, they must be protected by a `Mutex`.

INet library

20.1	INet	401
20.2	HTTP	402
20.3	JSON	403
20.3.1	JSON parsing and conversion to data in C	405
20.3.2	Mapping between Json and C	408
20.3.3	Convert from C to JSON	409
20.4	URL	411
20.5	Base64	413

20.1. INet

The **INet** library implements general Internet protocols. Although “*Sockets*” (page 187) allow us to open a communication channel between two remote machines, it is necessary to define a format for the messages that both interlocutors will exchange, in order for communication to be carried out satisfactorily. Any modern operating system provides APIs to use the most popular Internet services, like HTTP. INet accesses this functionality under a common unified and simplified interface (Figure 20.1).

Important. *To use INet in your projects, you will have to link the library explicitly in the CMakeLists.txt of your application.*

```
nap_desktop_app(Products "" NRC_EMBEDDED)
nap_link_inet(Products)
```

Important. *On Linux you will need to install the curl development libraries.*

```
sudo apt-get install libcurl4-openssl-dev
```

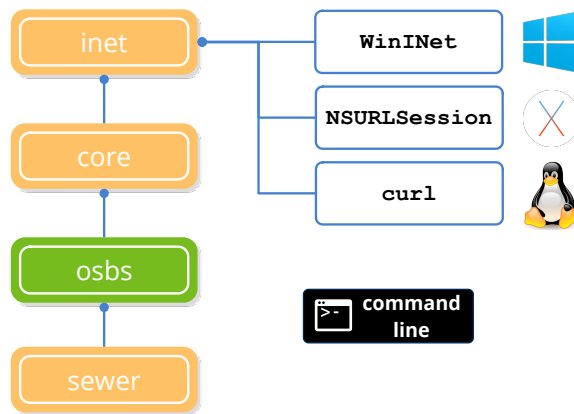

Figure 20.1: *INet* dependencies. See “*NAppGUI API*” (page 151) .

20.2. HTTP

It is common for an application to need information beyond that stored on the computer itself. The simplest and most common way to share information is to store it on a Web Server and publish a URL that provides the desired content (Figure 20.2). This client/server scheme uses the HTTP/HTTPS protocol, which was originally designed to transmit HTML documents between web servers and browsers. Due to the great impact it has had over the years, its use has been expanding for the exchange of structured information between any application that “understands” HTTP. The response from the server will usually be a block of text formatted in JSON or XML.

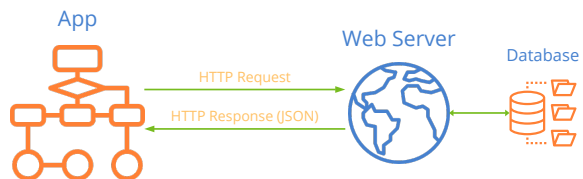

Figure 20.2: Requesting a remote resource using HTTP.

- Use `http_dget` to download a resource from its “URL” (page 411) (Listing 20.1).
- Use `http_create` to create an HTTP session.
- Use `http_secure` to create an HTTPS session (encrypted).

Listing 20.1: Direct download of content from a URL.

```
Stream *webpage = http_dget("https://nappgui.com/en/start/win_mac_linux.  
    ↪ html", NULL, NULL);  
Stream *imgdata = http_dget("http://test.nappgui.com/image_formats/  
    ↪ sea_02_rgb.png", NULL, NULL);
```

```

Image *image = image_read(imgdata);

if (webpage != NULL)
{
    ...
    stm_close(&webpage);
}

```

On the other hand, if we are going to make successive calls to the same server or if we need more control over the HTTP headers, we must create a session (Listing 20.2).

Listing 20.2: HTTP session.

```

Stream *webpage = NULL;

Http *http = http_secure("nappgui.com", UINT16_MAX);
if (http_get(http, "/en/start/win_mac_linux.html", NULL, 0, NULL) == TRUE)
{
    if (http_response_status(http) == 200)
    {
        webpage = stm_memory(1024);
        if (http_response_body(http, webpage, NULL) == FALSE)
            stm_close(&webpage);
    }
}

http_destroy(&http);

if (webpage != NULL)
{
    ...
    stm_close(&webpage);
}

```

20.3. JSON

JSON *JavaScript Object Notation*, is a data format in text mode that allows to easily represent basic types, objects and arrays. Although its use has become popular in the Web environment, it can also be used for other purposes, such as configuration files or local exchange. Its syntax is easy to understand for humans and simple to process for machines. In (Listing 20.3) we reproduce a small fragment of the JSON response of a Web service:

Listing 20.3: JSON fragment returned by a Web Service.

```

{
    "code":0,
    "size":80,

```

```

"data":[
  {
    "id":0,
    "code":"i7-8700K",
    "description":"Intel BX80684I78700K 8th Gen Core i7-8700K Processor",
    "type":0,
    "price":374.89,
    "image":"cpu_00.jpg",
    "image64":"\/9j\/4AAQSkZJRgABAQ...."
  },
  {
    "id":1,
    "code":"G3930",
    "description":"Intel BX80677G3930 7th Gen Celeron Desktop Processors",
    "type":0,
    "price":51.95,
    "image":"cpu_01.jpg",
    "image64":"\/9j\/4AAQSkZJRgABAQAAQABAAD..."
  },
  ...
]
}

```

In its structure we can find these data types:

- **Booleans:** Represented by constants `true` or `false`.
- **Numbers:** Use the exponential notation of C for floating-point values: `2.3`, `.76`, `-0.54` or `5.6e12` they are valid examples of numerical values. JSON does not distinguish between integers, negatives or reals.
- **Strings:** Any text in quotes is considered a string. Supports any Unicode character in “*UTF-8*” (page 164) or through the escape sequence `<c >\uXXXX</c >` to indicate the codepoint.
- **Arrays:** Lists of items delimited by brackets `[...]` and separated by commas. The values do not have to be the same type as usually happens in some programming languages (Listing 20.4).

Listing 20.4: JSON array

```

[
  "Red", "Green", "Blue", "Yellow"
]

```

- **Objects:** They are delimited by keys and composed of several fields separated by commas. Each field is formed by an identifier (string) followed by a colon and a value that can be any simple type, object or array (Listing 20.5).

Listing 20.5: JSON object

```
{
  "field1" : true,
  "field2" : 24.67,
  "field3" : "Hello Pipe",
  "field4" : [1, 2, 4, 8.4],
  "field5" : { "x" : 34.32, "y" : -6.19 }
}
```

- **null:** Indicates the absence of value.
- **Binaries:** JSON does not support binary data so opaque objects (images, for example) must be encoded in text and transmitted as a string type value. The most widespread and globally supported format is the “Base64” (page 413) where each character represents 6 bits of information.

NAppGUI's JSON parser automatically transforms Image objects to Base64 and vice-versa, allowing images to be embedded as data fields.

20.3.1. JSON parsing and conversion to data in C

NAppGUI allows automatic parsing of Json information.

- Use `json_read` to translate a Json to C.
- Use `json_destroy` to destroy a previously read object.

Next we will show different examples with basic types, arrays and objects. In “Read/Write Json” (page 775) you have the complete code. The first step is to create a `Stream` with the content of the Json (Listing 20.6):

Listing 20.6: Create a Stream with Json data.

```
/* Json data from web service */
Stream *stm = http_dget("http://serv.nappgui.com/dproducts.php", NULL, NULL);

/* Json data from disk file */
Stream *stm = hfile_stream("/home/fran/appdata/products.json", NULL);

/* Json data from memory block */
const char_t *data = "[12, 34, 67, 45]";
Stream *stm = stm_from_block((const byte_t*)data, str_len_c(data));
```

The Stream should be destroyed with `stm_close` at the end of the analysis.

Later we will use `json_read` indicating the expected data type of the Json.

Listing 20.7: Json boolean.

```

json: true

bool_t *json = json_read(stm, NULL, bool_t);
bstd_printf("Json boolean: %d\n", *json);
json_destroy(&json, bool_t);

```

Listing 20.8: Json number.

```

json: 6654

uint16_t *json = json_read(stm, NULL, uint16_t);
bstd_printf("Json unsigned int: %d\n", *json);
json_destroy(&json, uint16_t);

```

Listing 20.9: Json string.

```

json: "Hello World"

String *json = json_read(stm, NULL, String);
bstd_printf("Json string: %s\n", tc(json));
json_destroy(&json, String);

```

Listing 20.10: Json string/b64 image (jpg, png, bmp).

```

json: "/9j/4QB4RXhpZgAASUkqAAgAAA..."

Image *json = json_read(stm, NULL, Image);
uint32_t width = image_width(json);
uint32_t height = image_height(json);
bstd_printf("Json image: width: %d height: %d\n", width, height);
json_destroy(&json, Image);

```

Listing 20.11: Json integer array

```

json: [ -321, 12, -8943, 228, -220, 347 ]

ArrSt(int16_t) *json = json_read(stm, NULL, ArrSt(int16_t));
bstd_printf("Json array: ");
arrst_foreach(id, json, int16_t)
    bstd_printf("%d ", *id);
arrst_end()
bstd_printf("\n");
json_destroy(&json, ArrSt(int16_t));

```

Listing 20.12: Json string array

```

json: [ "Red", "Green", "Blue", "Yellow", "Orange" ]

ArrPt(String) *json = json_read(stm, NULL, ArrPt(String));

```

```

bstd_printf("Json array: ");
arrpt_foreach(str, json, String)
    bstd_printf("%s ", tc(str));
arrpt_end()
bstd_printf("\n");
json_destroy(&json, ArrPt(String));

```

For the analysis of objects it is necessary that we register with “*Data binding*” (page 233) their structure, in such a way that the types and names of the fields of the Json object coincide with the struct from C. Given this Json:

Listing 20.13: Json object

```

{
  "size" : 3,
  "data" : [
    {
      "description" : "Intel i7-7700K",
      "price" : 329.99
    },
    {
      "description" : "Ryzen-5-1600",
      "price" : 194.99
    },
    {
      "description" : "GTX-1060",
      "price" : 449.99
    }
  ]
}

```

We define these structs and register them:

Listing 20.14: Structures that will hold the data of the Json object.

```

typedef struct _product_t Product;
typedef struct _products_t Products;

struct _product_t
{
    String *description;
    real32_t price;
};

struct _products_t
{
    uint32_t size;
    ArrSt(Product) *data;
};

DeclSt(Product);

```



```

dbind(Product, String*, description);
dbind(Product, real32_t, price);
dbind(Products, uint32_t, size);
dbind(Products, ArrSt(Product)*, data);

```

This way we can now call `json_read`:

Listing 20.15: Reading the Json object.

```

Products *json = json_read(stm, NULL, Products);
bstd_printf("Json object: Size %d\n", json->size);
arrst_foreach(elem, json->data, Product)
    bstd_printf("Product: %s Price %.2f\n", tc(elem->description), elem->price)
    ↪ ;
arrst_end()
bstd_printf("\n");
json_destroy(&json, Products);

```

`json_read()` ignores (skips) those fields of Json objects that are not registered with `dbind`. In no case will they generate caches or dynamic memory.

20.3.2. Mapping between Json and C

`json_read` recognizes the basic NAppGUI types, as well as `String`, `Image`, `ArrSt`, and `ArrPt`. **Will not work with other data types** such as `int` or `float`. It will also not recognize the STL structures `vector`, `map`, etc. In (Table 20.1) we show the equivalence between the fields of a Json and the C types that we need to map it correctly.

Json	C	
boolean	<code>bool_t</code>	true, false
number	<code>int8_t</code> , <code>int16_t</code> , <code>int32_t</code> , <code>int64_t</code>	-6785, 45, 0
number	<code>uint8_t</code> , <code>uint16_t</code> , <code>uint32_t</code> , <code>uint64_t</code>	1, 36734, 255, 0, 14
number	<code>real32_t</code> , <code>real64_t</code>	67.554, -3.456, 1.5e7
string	<code>String</code>	“Intel Celeron”, “Red”
string	<code>Image</code>	“/9j/4QB4RXhpZgAASUkqAAgAAA...”
array	<code>ArrSt(uint16_t)</code>	[12, 111, 865]
array	<code>ArrSt(real32_t)</code>	[-34.89, 0.0001, 567.45, 1e6]
array	<code>ArrPt(String)</code>	[“red”, “green”, “blue”]

Json	C	
array	<code>ArrPt(Image)</code>	[<code>"/9j/4QB4RXh..."</code> , <code>"/9j/4QB4RXh..."</code>]
object	<code>struct Product</code> (<i>"Data binding"</i> (page 233))	{ <code>"description"</code> : <code>"i7-8700K"</code> , <code>"price"</code> :
array	<code>ArrSt(Product)</code>	[{ <code>"description"</code> : <code>"i7-8700K"</code> , <code>"price"</code> :
array	<code>ArrPt(Product)</code>	[{ <code>"description"</code> : <code>"i7-8700K"</code> , <code>"price"</code> :

Table 20.1: Equivalence between Json and NAppGUI types.

20.3.3. Convert from C to JSON

- Use `json_write` to write data/objects from C to Json.

Based again on (Table 20.1), let's do the reverse process and generate Json data from C types and objects. First, create a write stream to hold the result (Listing 20.16):

Listing 20.16: Create a write Stream.

```
/* Write stream in memory */
Stream *stm = stm_memory(2048);

/* Write stream in disk */
Stream *stm = stm_to_file("/home/fran/appdata/products.json", NULL);
```

The Stream should be destroyed with `stm_close` when it is no longer needed.

Later we will use `json_write` indicating the expected data type of the Json.

Listing 20.17: Write boolean to Json.

```
bool_t data_bool = TRUE;
stm_writef(stm, "Json from bool_t: ");
json_write(stm, &data_bool, NULL, bool_t);

// Json from bool_t: true
```

Listing 20.18: Write integer to Json.

```
uint16_t data_uint = 6654;
stm_writef(stm, "Json from uint16_t: ");
json_write(stm, &data_uint, NULL, uint16_t);

// Json from uint16_t: 6654
```

Listing 20.19: Write String to Json.

```
String *data_str = str_c("Hello World");
```

```
stm_writef(stm, "Json from String: ");
json_write(stm, data_str, NULL, String);
str_destroy(&data_str);

// Json from String: "Hello World"
```

Listing 20.20: Write Image to Json.

```
Image *data_image = load_image();
stm_writef(stm, "Json from Image: ");
json_write(stm, data_image, NULL, Image);
image_destroy(&data_image);

// Json from Image: "iVBORw0KGgoAAAANSUhhEUGAAAAIA..."
```

Listing 20.21: Write ArrSt(int16_t) to Json.

```
ArrSt(int16_t) *array = arrst_create(int16_t);
arrst_append(array, -321, int16_t);
arrst_append(array, 12, int16_t);
arrst_append(array, -8943, int16_t);
arrst_append(array, 228, int16_t);
arrst_append(array, -220, int16_t);
arrst_append(array, 347, int16_t);
stm_writef(stm, "Json from int array: ");
json_write(stm, array, NULL, ArrSt(int16_t));
arrst_destroy(&array, NULL, int16_t);

// Json from int array: [ -321, 12, -8943, 228, -220, 347 ]
```

Listing 20.22: Write ArrPt(String) to Json.

```
ArrPt(String) *array = arrpt_create(String);
arrpt_append(array, str_c("Red"), String);
arrpt_append(array, str_c("Green"), String);
arrpt_append(array, str_c("Blue"), String);
arrpt_append(array, str_c("Yellow"), String);
arrpt_append(array, str_c("Orange"), String);
stm_writef(stm, "Json from string array: ");
json_write(stm, array, NULL, ArrPt(String));
arrpt_destroy(&array, str_destroy, String);

// Json from string array: [ "Red", "Green", "Blue", "Yellow", "Orange" ]
```

Listing 20.23: Write Products object to Json.

```
Products *products = heap_new(Products);
products->size = 3;
products->data = arrst_create(Product);

{
```

```

Product *product = arrst_new(products->data, Product);
product->description = str_c("Intel i7-7700K");
product->price = 329.99f;
}

{
Product *product = arrst_new(products->data, Product);
product->description = str_c("Ryzen-5-1600");
product->price = 194.99f;
}

{
Product *product = arrst_new(products->data, Product);
product->description = str_c("GTX-1060");
product->price = 449.99f;
}

stm_writelf(stm, "Json from object: ");
json_write(stm, products, NULL, Products);
dbind_destroy(&products, Products);

// Json from object: {"size" : 3, "data" : [ {"description" : "Intel i7-7700K",
↪ "price" : 329.989990 }, {"description" : "Ryzen-5-1600", "price" :
↪ 194.990005 }, {"description" : "GTX-1060", "price" : 449.989990 } ] }

```

20.4. URL

URL is the acronym for *Uniform Resource Locator* that identifies a unique resource on the Internet. The most common use is found when making requests to a Web server. For example `https://www.google.com` is a widely recognized and used URL. Being somewhat more specific, we can say that it is a string of characters with a specific format composed of a series of fields that allow unambiguously locating a unique global resource (Listing 20.24) (Figure 20.3).

Listing 20.24: Parsing a URL string.

```

Url *url = url_parse("https://frang@www.nappgui.com/services/demo/userlist.php?
↪ id=peter&city=Alicante");
const char_t *scheme = url_scheme(url); // https
const char_t *host = url_host(url);     // www.nappgui.com
const char_t *path = url_path(url);     // /services/demo/userlist.php
const char_t *query = url_query(url);   // id=peter&city=Alicante

```

- **Scheme:** Communication protocol used. **http**, **https**, **ftp**, **smtp**, **mailto**, etc.
- **Authority:** Access string to the server composed of several fields, where only the host name is required. The rest are optional.

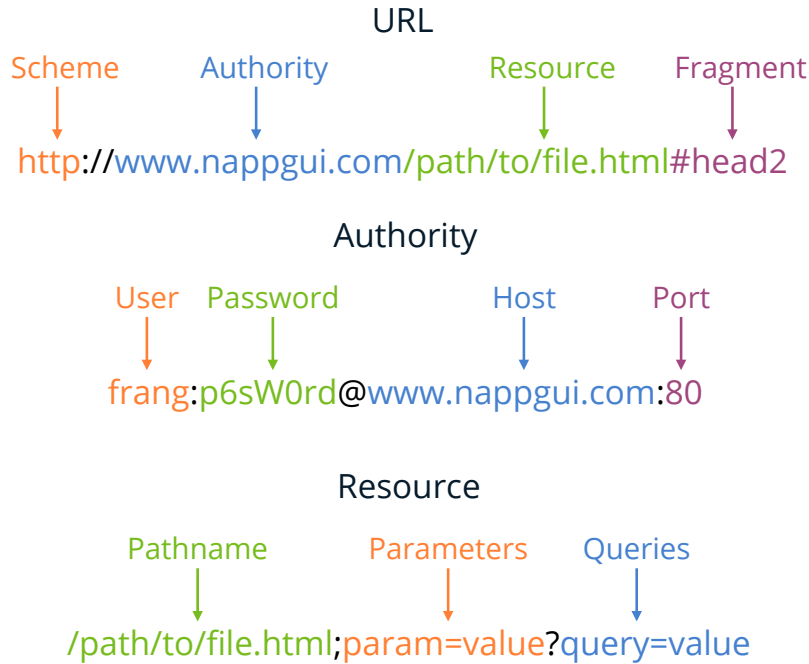

Figure 20.3: The different fields that make up a URL.

- **Host:** Server name or IP address.
- **User:** User name. Optional, only if the service requires it.
- **Password:** Password. Optional, only if the service requires it.
- **Port:** Access port. Each protocol has a default port, which will be the one used if none is specified. 80 = http, 413 = https.
- **Resource:** Path within the server where the resource we are looking for is located. The *pathname* is the only one required.
 - **Pathname:** Directory and name of the file or resource.
 - **Parameters:** List of name = value arguments that the service may need. Not normally used. If there are multiple values, they are separated by the character '&'.
 - **Queries:** List of name = value arguments that the service may need. These are the ones normally used by Web services. That is, in the URL you must use the '?' separator instead of ';' after the *pathname*. If there are multiple values, they are separated by the character '&'.
- **Fragment:** It is an anchor to a specific part of the document that we request from

the server. Normally used to access a specific point in an HTML page.

20.5. Base64

OGL3D library

21.1	OGL3D	415
21.2	3D Contexts	416
21.3	Drawing operation	417
21.4	GLEW	418

21.1. OGL3D

The **OGL3D** library will allow us to create cross-platform OpenGL contexts, without having to worry about the particular implementation in each operating system (Figure 21.1). Although the OpenGL API is fully portable, the way you create graphical contexts and link them to a window is platform-dependent. In “*Hello 3D Graphics!*” (page 649) you have an example application.

Important. *To use OGL3D in your projects, you will have to link the library explicitly in the `CMakeLists.txt` of your application.*

```
nap_desktop_app(GLHello "" NRC_EMBEDDED)
nap_link_opengl(GLHello)
```

Important. *On Linux you will need to install the Mesa development libraries.*

```
sudo apt-get install mesa-common-dev libegl-mesa-dev
```

Figure 21.1: OGL3D dependencies. See “NAppGUI API” (page 151).

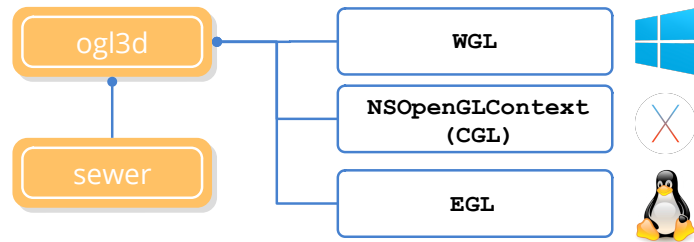

21.2. 3D Contexts

Use `ogl3d_context` to create a context.

Use `ogl3d_destroy` to destroy a context.

A 3D context represents a set of states and objects within which OpenGL drawing operations are performed (Figure 21.2). Basically a context includes:

- States: Current settings such as projection mode, transformation matrices, lighting options, etc.
- Shaders: Programs that allow you to customize the rendering within the GPU.
- Geometry and textures: Graphic resources that represent the objects to be rendered.
- Graphic buffers: Color, depth, stencil, and others that are used to store pixel information during the rendering process.
- Windows: Integration with the operating system to draw in a specific window.

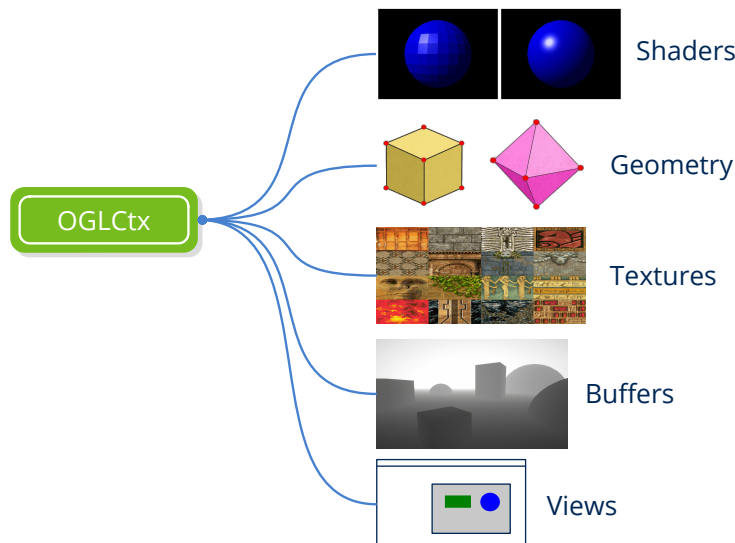

Figure 21.2: OpenGL context and associated objects.

To create a context you will need the native identifier of the associated view. That is, a `HWND` object on Windows, a `GtkWidget` on Linux or a `NSView` on macOS. In `NAppGUI`, this is provided by the `view_native` function (Listing 21.1).

Listing 21.1: Creating an OpenGL context, associated with a window.

```
View *view = ....
void *nview = view_native(view);
OGLCtx *oglctx = NULL;
OGLProps props;
oglerr_t err;
props.api = ekOGL_3_3;
props.hdaccel = TRUE;
props.color_bpp = 32;
props.depth_bpp = 0;
props.stencil_bpp = 0;
props.aux_buffers = 0;
props.transparent = FALSE;
props.shared = NULL;
oglctx = ogl3d_context(&props, nview, &err);
if (oglctx == NULL)
{
    bstd_printf("Error: %s\n", ogl3d_err_str(err));
}
```

21.3. Drawing operation

- Use `ogl3d_begin_draw` when starting rendering.
- Use `ogl3d_end_draw` when finishing rendering.

The `View` object will raise an `OnDraw` event every time it needs to update the drawing area (“*Draw in views*” (page 328)). In the handler for this event, we must include the OpenGL code.

Listing 21.2: Drawing in a view, using OpenGL.

```
static void i_OnDraw(App *app, Event *e)
{
    const EvDraw *p = event_params(e, EvDraw);
    ogl3d_begin_draw(app->oglctx);

    // OpenGL Code (cross-platform)
    glViewport(0, 0, (GLsizei)p->width, (GLsizei)p->height);
    glClearColor(.8f, .8f, .8f, 1.0f);
    glClear(GL_COLOR_BUFFER_BIT);
    glMatrixMode(GL_MODELVIEW);
    glLoadIdentity();
    glBegin(GL_TRIANGLES);
    glColor3f(1, 0, 0);
```

```

    glVertex3f(0, 1, 0);
    glColor3f(0, 1, 0);
    glVertex3f(-1, -1, 0);
    glColor3f(0, 0, 1);
    glVertex3f(1, -1, 0);
    glEnd();

    ogl3d_end_draw(ogl->ctx);
}
...
view_OnDraw(view, listener(app, i_OnDraw, App));

```

21.4. GLEW

OpenGL allows the incorporation of **optional extensions** that are not included in the core of the standard. These extensions allow hardware manufacturers (such as NVIDIA, AMD, Intel, etc.) and software developers to add new functionality or improve the performance of existing features. In general, detecting whether an extension is present or not when creating a context implies a great workload for the programmer, which is why different libraries have been created for this purpose.

OGL3D includes a copy of **GLEW**¹ (*OpenGL Extension Wrangler Library*) which facilitates this task enormously. Its initialization by calling `glewInit()` is done automatically when creating the `OGLCtx` object. We will only have to include this header before making any call to OpenGL (Listing 21.3).

Listing 21.3: GLEW inclusion.

```

// Include OpenGL and GLEW
#include "nowarn.hxx"
#include <ogl3d/glew.h>
#include "warn.hxx"
...
// OpenGL calls
glViewport(0, 0, (GLsizei)width, (GLsizei)height);
glClearColor(.8f, .8f, .8f, 1.0f);
glClear(GL_COLOR_BUFFER_BIT);
glMatrixMode(GL_MODELVIEW);
...

```

To check if an extension is present, we can use `glewIsSupported()` or the different macros provided by GLEW (Listing 21.4).

Listing 21.4: Checking extensions with GLEW.

```

if (glewIsSupported("GL_ARB_vertex_program"))

```

¹<https://glew.sourceforge.net>

```
{  
    // Extension available  
}  
...  
if (GLEW_ARB_vertex_program)  
{  
    // Extension available  
}
```

Part 3

Sample Applications

Die

Beautiful code is likely to be simple – clear and easy to understand. Beautiful code is likely to be compact – just enough code to do the job and no more – but not cryptic, to the point where it cannot be understood. Beautiful code may well be general, solving a broad class of problems in a uniform way. One might even describe it as elegant, showing good taste and refinement.

Brian Kernighan

22.1	Die	423
22.2	Use of sublayouts	424
22.3	Use of Custom Views	426
22.4	Parametric drawing	427
22.5	Resizing	429
22.6	Use of resources	431
22.7	Die and Dice	432
22.8	The complete Die program	433

22.1. Die

As the road is made by walking, we will devote a few chapters to deepen the use of NAppGUI hand in hand with real applications. Our goal is to present programs of a certain level, halfway between the simple “book examples” and the commercial applications. In this first demo we have a program that allows us to draw the silhouette of a die (Figure 22.1) and that will serve as an excuse to introduce concepts of parametric drawing, composition of *layouts* and use of resources. The **source code** is in folder `/src/demo/die` of the SDK distribution. In “*Create new application*” (page 71) and “*Resources*” (page 99) we saw how to create the project from scratch.

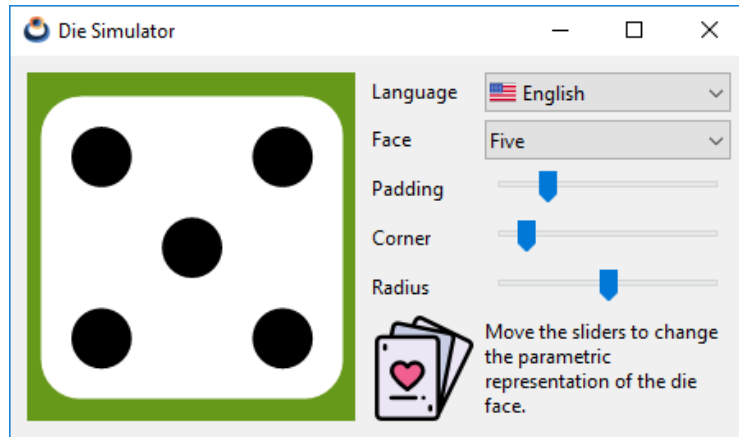

Figure 22.1: *Die Simulator* application, Windows version. Inspired by *DieView* (*Cocoa Programming for OSX*, Hillegass et al.)



Figure 22.2: MacOS version.

22.2. Use of sublayouts

We started working on the user interface, which we have divided into two areas: a customized view (`View`) where we will draw the representation of the die in 2D, and a zone of controls where we can interact with this drawing. As we already saw in “*Hello World!*” (page 23) we will use `Layout` objects to locate the controls inside the main window. However, we observe that this arrangement of elements does not fit well in a single table, therefore, we will use two horizontal cells as the main container and a *grid* of two columns and six rows for the controls (Listing 22.1) (Listing 22.1). This second layout will be located in the right cell of the first container and we will say that it is a **sublayout** of the main layout.



Figure 22.3: Linux/GTK+ version.

Listing 22.1: Composition through sublayouts.

```
Layout *layout = layout_create(2, 1);
Layout *layout1 = layout_create(2, 6);
layout_view(layout, view, 0, 0);
layout_label(layout1, label1, 0, 0);
layout_label(layout1, label2, 0, 1);
layout_label(layout1, label3, 0, 2);
layout_label(layout1, label4, 0, 3);
layout_label(layout1, label5, 0, 4);
layout_view(layout1, vimg, 0, 5);
layout_popup(layout1, popup1, 1, 0);
layout_popup(layout1, popup2, 1, 1);
layout_slider(layout1, slider1, 1, 2);
layout_slider(layout1, slider2, 1, 3);
layout_slider(layout1, slider3, 1, 4);
layout_label(layout1, label6, 1, 5);
layout_layout(layout, layout1, 1, 0);
```

In the same way that we did in “*Layout format*” (page 29) we have established certain margins and a fixed width for the controls column.

Listing 22.2: Layout format

```
view_size(view, s2df(200.f, 200.f));
layout_margin(layout, 10.f);
layout_hsize(layout1, 1, 150.f);
layout_hmargin(layout, 0, 10.f);
layout_hmargin(layout1, 0, 5.f);
layout_vmargin(layout1, 0, 5.f);
layout_vmargin(layout1, 1, 5.f);
layout_vmargin(layout1, 2, 5.f);
```

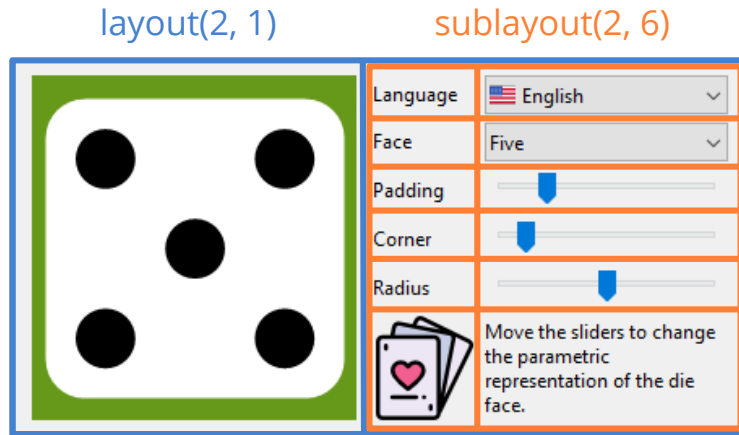

Figure 22.4: The use of sublayouts adds flexibility when designing the *gui*.

```
layout_vmargin(layout1, 3, 5.f);
layout_vmargin(layout1, 4, 5.f);
```

22.3. Use of Custom Views

`View` are controls that will allow us to design our own *widgets*. On the contrary that happens with another type of components, like “*Slider*” (page 326) or “*Button*” (page 316), here we will have total freedom to draw anything. We can interact with the control by capturing its events (mouse, keyboard, etc) and implementing the appropriate handlers. These views are integrated into the layout like any other component (Listing 22.3).

Listing 22.3: Creating a custom view.

```
View *view = view_create();
view_size(view, s2df(200.f, 200.f));
layout_view(layout, view, 0, 0);
```

We can not draw inside a `View` whenever we want. We will have to make a request to the operating system through the method `view_update` (Listing 22.4), since the drawing area can affect overlapping windows and this must be managed centrally. When the control is ready to refresh, the system will send an event `EvDraw` that we must capture through `view_OnDraw`.

Listing 22.4: Code basic of View refresh.

```
static void i_OnPadding(App *app, Event *e)
{
    const EvSlider *params = event_params(e, EvSlider);
```

```

    app->padding = params->pos;
    view_update(app->view);
}

static void i_OnDraw(App *app, Event *e)
{
    const EvDraw *params = event_params(e, EvDraw);
    die_draw(params->context, params->width, params->height, app);
}

slider_OnMoved(slider1, listener(app, i_OnPadding, App));
view_OnDraw(view, listener(app, i_OnDraw, App));

```

Each time the user moves a slider (padding parameter, for example) the operating system captures the action and informs the application through the method `i_OnPadding` (Figure 22.5). Because the action involves a change in the drawing, this method calls `view_update` to inform the system again that the view must be updated. When it considers it appropriate, send the event `EvDraw`, which is captured by `i_OnDraw` where the drawing is regenerated with the new parameters.

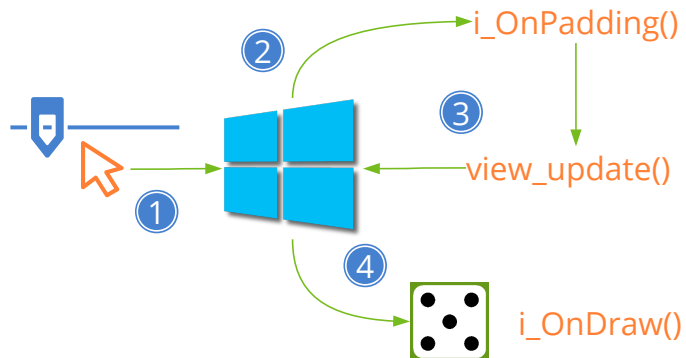

Figure 22.5: Understanding the event flow in interactive drawings.

22.4. Parametric drawing

Under this concept we describe the ability to generate vector images from a few numerical values known as parameters (Figure 22.6). It is used a lot in the computer-aided design (CAD), it allows you to make adjustments easily in planes or models without having to edit, one by one, a lot of primitives.

In our application, the representation of the die can change at runtime as the user manipulates the sliders or sizes the window, so we calculate the position and size of their primitives using parametric formulas. Once resolved, we created the drawing with three simple API commands “*Drawing primitives*” (page 273).

- `draw_clear`. Clear the entire drawing area using a solid color.

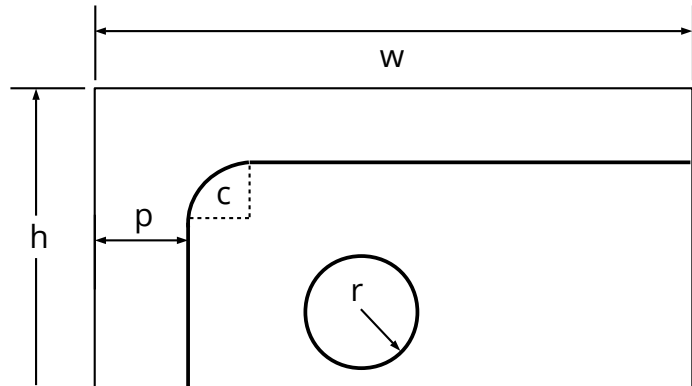

Figure 22.6: Principles of parametric drawing, applied in Die.

- `draw_rndrect`. Draw a rectangle with rounded corners.
- `draw_circle`. Draw a circle.

Listing 22.5: `demo/casino/ddraw.c`

```

/* Die drawing */

#include "ddraw.h"
#include <draw2d/draw2dall.h>

/*
↪ -----
↪ */

static const real32_t i_MAX_PADDING = 0.2f;
const real32_t kDEF_PADDING = .15f;
const real32_t kDEF_CORNER = .15f;
const real32_t kDEF_RADIUS = .35f;

/*
↪ -----
↪ */

void die_draw(DCtx *ctx, const real32_t x, const real32_t y, const
↪ real32_t width, const real32_t height, const real32_t padding,
↪ const real32_t corner, const real32_t radius, const uint32_t face)
{
    color_t white = color_rgb(255, 255, 255);
    color_t black = color_rgb(0, 0, 0);
    real32_t dsize, dx, dy;
    real32_t rc, rr;
    real32_t p1, p2, p3;

    dsize = width < height ? width : height;
    dsize -= bmath_floorf(2.f * dsize * padding * i_MAX_PADDING);
    dx = x + .5f * (width - dsize);

```

```

dy = y + .5f * (height - dsize);
rc = dsize * (.1f + .3f * corner);
rr = dsize * (.05f + .1f * radius);
p1 = 0.5f * dsize;
p2 = 0.2f * dsize;
p3 = 0.8f * dsize;

draw_fill_color(ctx, white);
draw_rndrect(ctx, ekFILL, dx, dy, dsize, dsize, rc);
draw_fill_color(ctx, black);

if (face == 1 || face == 3 || face == 5)
    draw_circle(ctx, ekFILL, dx + p1, dy + p1, rr);

if (face != 1)
{
    draw_circle(ctx, ekFILL, dx + p3, dy + p2, rr);
    draw_circle(ctx, ekFILL, dx + p2, dy + p3, rr);
}

if (face == 4 || face == 5 || face == 6)
{
    draw_circle(ctx, ekFILL, dx + p2, dy + p2, rr);
    draw_circle(ctx, ekFILL, dx + p3, dy + p3, rr);
}

if (face == 6)
{
    draw_circle(ctx, ekFILL, dx + p2, dy + p1, rr);
    draw_circle(ctx, ekFILL, dx + p3, dy + p1, rr);
}
}

```

The drawing commands are reflected on a canvas, also known as context `Dctx`. This object reaches to `i_OnDraw` as parameter of the event `EvDraw`. In this case, the canvas is provided by the `View` control itself, but it is also possible to create contexts to draw directly in memory.

22.5. Resizing

In this application, the window can be resized by stretching the cursor over its edges, which is common in desktop programs. Let's see some basic aspects about this feature not present in *"Hello World!"* (page 23), which had a static window. The first thing is to enable the option inside the window's constructor.

```

window_create(ekWINDOW_STDRES, &panel);

```

When a window changes in size, the inner controls should do so proportionally as well

as change its location within the panel. This management is carried out within each `Layout` object. When the window starts, the default size of each layout is calculated by applying the **natural sizing**, which is the result of the initial size of the controls plus the margins, as we saw in “*Layout format*” (page 29). When we stretch or contract the window, the pixel difference between natural and real dimensioning is distributed between the columns of the layout (Figure 22.7). The same happens with the vertical difference, which is distributed among its rows. If a cell contains a sublayout, this increment will be recursively distributed by its own columns and rows.

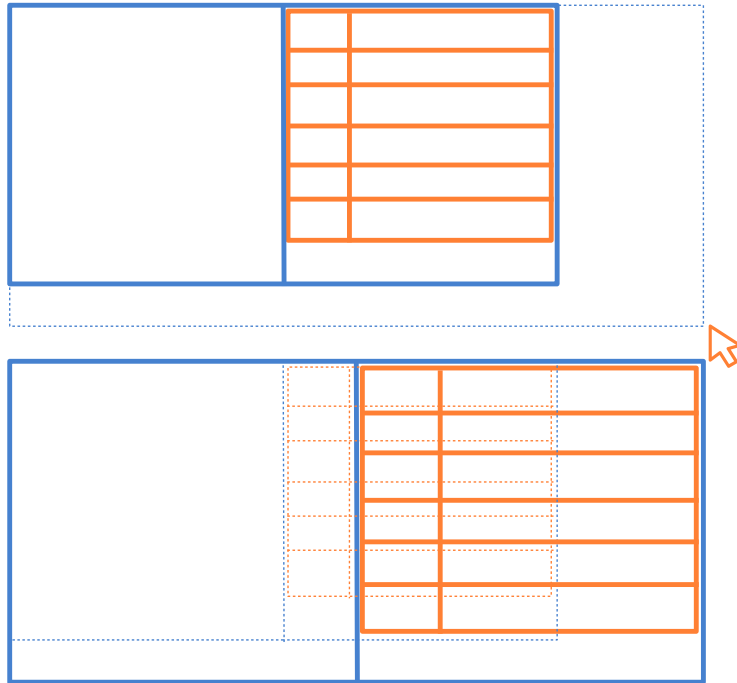

Figure 22.7: When resizing, the excess of pixels is distributed proportionally by the rows and columns of the `Layout`.

But in this particular case, we want the whole increment to go to the drawing area (column 0). In other words, we want the column of the controls to remain fixed and not grow (Figure 22.8). For this we must change the proportion of the resized:

```
layout_hexpand(layout, 0);
```

With this function 100% of the horizontal surplus will go to column 0. By default, they had a proportion of (50%, 50%) since they are two columns (33% for three, 25% for four, etc). With this we would have resolved the resizing for the X dimension of the window, but what happens with the vertical? In the main layout, we only have one row that, when expanded, will change the height of the custom view. But this expansion will also affect the

cell on the right, where the controls will also grow vertically due to the recursive increase of pixels in the sublayout rows. To solve it, we force the vertical alignment `ekTOP` in the right cell of the layout.

```
layout_valign(layout, 1, 0, ekTOP);
```

instead of `ekJUSTIFY`, which is the default alignment for sublayouts. In this way, the content of the cell (the entire sublayout) will not expand vertically, but it will adjust to the upper edge leaving all the free space in the lower part of the cell. Obviously, if we use `ekCENTER` or `ekBOTTOM`, the sublayout will center or adjust to the bottom edge.

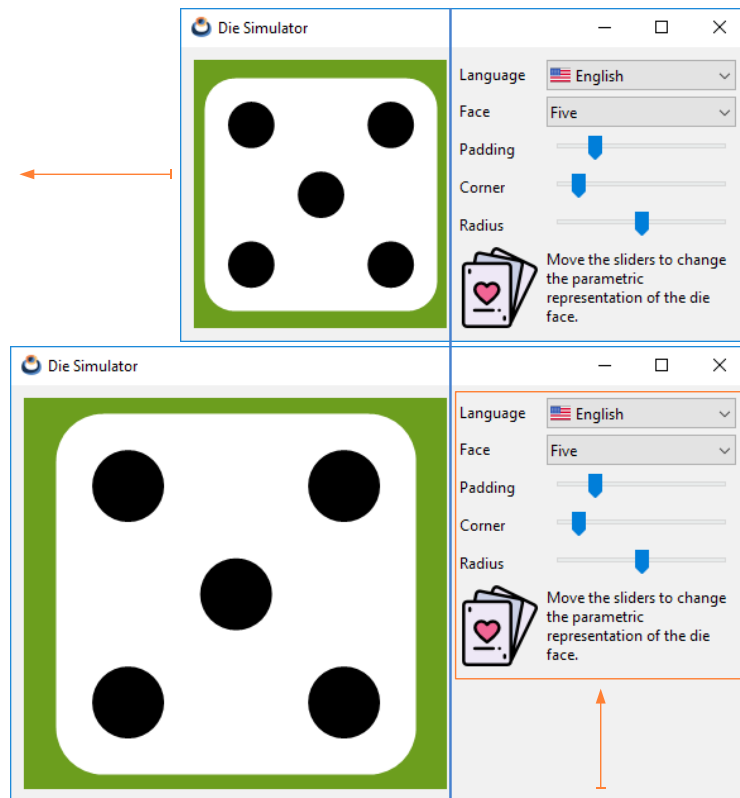

Figure 22.8: Playing with the horizontal ratio and vertical alignment, only the drawing area will be affected by the size changes.

22.6. Use of resources

Both the text and the icons that we have used in *Die* have been outsourced in the resource package `a11`. Thanks to this, we can perform an automatic translation of the interface between the English and Spanish languages. You can check “*Resources*” (page 99)

to get detailed information on how text and images have been assigned in the program interface.

Listing 22.6: demo/die/res/res_die/strings.msg

```

/* Die strings */
TEXT_FACE          Face
TEXT_PADDING       Padding
TEXT_CORNER        Corner
TEXT_RADIUS        Radius
TEXT_ONE           One
TEXT_TWO           Two
TEXT_THREE         Three
TEXT_FOUR          Four
TEXT_FIVE          Five
TEXT_SIX           Six
TEXT_TITLE         Die Simulator
TEXT_INFO          Move the sliders to change the parametric representation of the
    ↪ die face.
TEXT_LANG          Language
TEXT_ENGLISH       English
TEXT_SPANISH       Spanish

```

Listing 22.7: demo/die/res/res_die/es_es/strings.msg

```

/* Die strings */
TEXT_FACE          Cara
TEXT_PADDING       Margen
TEXT_CORNER        Borde
TEXT_RADIUS        Radio
TEXT_ONE           Uno
TEXT_TWO           Dos
TEXT_THREE         Tres
TEXT_FOUR          Cuatro
TEXT_FIVE          Cinco
TEXT_SIX           Seis
TEXT_TITLE         Simulador de dado
TEXT_INFO          Mueve los sliders para cambiar la representación paramétrica de
    ↪ la cara del dado.
TEXT_LANG          Idioma
TEXT_ENGLISH       Inglés
TEXT_SPANISH       Español

```

22.7. Die and Dice

This application has been used as a guiding thread of the “*Create new application*” (page 71) chapter and following from the NAppGUI tutorial. The complete example consists of two applications (**Die** and **Dice**), as well as the **casino** library that groups the

common routines for both programs (Figure 22.9). You have the three complete projects ready to compile and test in the folder `src/demo` of SDK distribution.

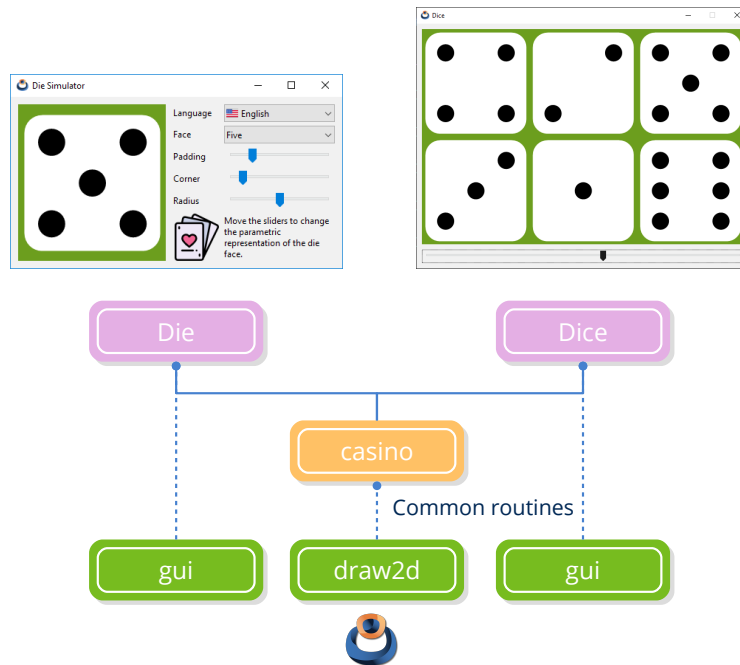

Figure 22.9: Common routines for both applications are shared through the `casino` library.

22.8. The complete Die program

Listing 22.8: `demo/die/die.hxx`

```

/* Die Types */

#ifndef __DIE_HXX__
#define __DIE_HXX__

#include <gui/gui.hxx>

typedef struct _app_t App;

struct _app_t
{
    real32_t padding;
    real32_t corner;
    real32_t radius;
    uint32_t face;
    View *view;
}

```

```

    Window *window;
};

#endif

```

Listing 22.9: demo/die/main.c

```

/* Die application */

#include "dgui.h"
#include <nappgui.h>

/*-----*/

static void i_OnClose(App *app, Event *e)
{
    osapp_finish();
    unref(app);
    unref(e);
}

/*-----*/

static App *i_create(void)
{
    App *app = heap_new0(App);
    app->padding = 0.2f;
    app->corner = 0.1f;
    app->radius = 0.5f;
    app->face = 5;
    app->window = dgui_window(app);
    window_origin(app->window, v2df(200.f, 200.f));
    window_OnClose(app->window, listener(app, i_OnClose, App));
    window_show(app->window);
    return app;
}

/*-----*/

static void i_destroy(App **app)
{
    window_destroy(&(*app)->window);
    heap_delete(app, App);
}

/*-----*/

#include "osmain.h"
osmain(i_create, i_destroy, "", App)

```

Listing 22.10: demo/die/dgui.c

```

/* Die Gui */

#include "dgui.h"
#include "ddraw.h"
#include "res_die.h"
#include <gui/guiall.h>

/*-----*/

static void i_OnDraw(App *app, Event *e)
{
    color_t green = color_rgb(102, 153, 26);
    const EvDraw *params = event_params(e, EvDraw);
    draw_clear(params->ctx, green);
    die_draw(params->ctx, 0, 0, params->width, params->height, app->padding,
             ↪ app->corner, app->radius, app->face);
}

/*-----*/

static void i_OnAcceptFocus(App *app, Event *e)
{
    bool_t *r = event_result(e, bool_t);
    unref(app);
    *r = FALSE;
}

/*-----*/

static void i_OnFace(App *app, Event *e)
{
    const EvButton *params = event_params(e, EvButton);
    app->face = params->index + 1;
    view_update(app->view);
}

/*-----*/

static void i_OnPadding(App *app, Event *e)
{
    const EvSlider *params = event_params(e, EvSlider);
    app->padding = params->pos;
    view_update(app->view);
}

/*-----*/

static void i_OnCorner(App *app, Event *e)
{
    const EvSlider *params = event_params(e, EvSlider);
    app->corner = params->pos;
}

```

```

    view_update(app->view);
}

/*-----*/

static void i_OnRadius(App *app, Event *e)
{
    const EvSlider *params = event_params(e, EvSlider);
    app->radius = params->pos;
    view_update(app->view);
}

/*-----*/

static void i_OnLang(App *app, Event *e)
{
    const EvButton *params = event_params(e, EvButton);
    const char_t *lang = params->index == 0 ? "en_us" : "es_es";
    gui_language(lang);
    unref(app);
}

/*-----*/

static Panel *i_panel(App *app)
{
    Panel *panel = panel_create();
    Layout *layout = layout_create(2, 1);
    Layout *layout1 = layout_create(2, 6);
    View *view = view_create();
    Label *label1 = label_create();
    Label *label2 = label_create();
    Label *label3 = label_create();
    Label *label4 = label_create();
    Label *label5 = label_create();
    Label *label6 = label_multiline();
    PopUp *popup1 = popup_create();
    PopUp *popup2 = popup_create();
    Slider *slider1 = slider_create();
    Slider *slider2 = slider_create();
    Slider *slider3 = slider_create();
    ImageView *img = imageview_create();
    app->view = view;
    view_size(view, s2df(200, 200));
    view_OnDraw(view, listener(app, i_OnDraw, App));
    view_OnAcceptFocus(view, listener(app, i_OnAcceptFocus, App));
    label_text(label1, TEXT_LANG);
    label_text(label2, TEXT_FACE);
    label_text(label3, TEXT_PADDING);
    label_text(label4, TEXT_CORNER);
    label_text(label5, TEXT_RADIUS);
}

```

```

label_text(label6, TEXT_INFO);
popup_add_elem(popup1, TEXT_ENGLISH, gui_image(USA_PNG));
popup_add_elem(popup1, TEXT_SPANISH, gui_image(SPAIN_PNG));
popup_OnSelect(popup1, listener(app, i_OnLang, App));
popup_add_elem(popup2, TEXT_ONE, NULL);
popup_add_elem(popup2, TEXT_TWO, NULL);
popup_add_elem(popup2, TEXT_THREE, NULL);
popup_add_elem(popup2, TEXT_FOUR, NULL);
popup_add_elem(popup2, TEXT_FIVE, NULL);
popup_add_elem(popup2, TEXT_SIX, NULL);
popup_OnSelect(popup2, listener(app, i_OnFace, App));
popup_selected(popup2, app->face - 1);
slider_value(slider1, app->padding);
slider_value(slider2, app->corner);
slider_value(slider3, app->radius);
slider_OnMoved(slider1, listener(app, i_OnPadding, App));
slider_OnMoved(slider2, listener(app, i_OnCorner, App));
slider_OnMoved(slider3, listener(app, i_OnRadius, App));
imageView_image(img, (const Image*)CARDS_PNG);
layout_view(layout, view, 0, 0);
layout_label(layout1, label1, 0, 0);
layout_label(layout1, label2, 0, 1);
layout_label(layout1, label3, 0, 2);
layout_label(layout1, label4, 0, 3);
layout_label(layout1, label5, 0, 4);
layout_imageview(layout1, img, 0, 5);
layout_popup(layout1, popup1, 1, 0);
layout_popup(layout1, popup2, 1, 1);
layout_slider(layout1, slider1, 1, 2);
layout_slider(layout1, slider2, 1, 3);
layout_slider(layout1, slider3, 1, 4);
layout_label(layout1, label6, 1, 5);
layout_layout(layout, layout1, 1, 0);
layout_margin(layout, 10);
layout_hsize(layout1, 1, 150);
layout_hmargin(layout, 0, 10);
layout_hmargin(layout1, 0, 5);
layout_vmargn(layout1, 0, 5);
layout_vmargn(layout1, 1, 5);
layout_vmargn(layout1, 2, 5);
layout_vmargn(layout1, 3, 5);
layout_vmargn(layout1, 4, 5);
layout_hexpand(layout, 0);
layout_valign(layout, 1, 0, ekTOP);
panel_layout(panel, layout);
return panel;
}

/*-----*/
Window *dgui_window(App *app)

```

```
{
    gui_repack(res_die_repack);
    gui_language("");

    {
        Panel *panel = i_panel(app);
        Window *window = window_create(ekWINDOW_STDRES);
        window_panel(window, panel);
        window_title(window, TEXT_TITLE);
        return window;
    }
}
```

Listing 22.11: demo/die/dgui.h

```
/* Die Gui */

#include "die.hxx"

__EXTERN_C

Window *dgui_window(App *app);

__END_C
```

Bricks

23.1 Bricks

439

23.1. Bricks

Briks is a very simplistic imitation of the **Atari Breakout** video game, which will allow us to make an introduction to the world of “*Synchronous applications*” (page 397). Any real-time application must be constantly updating whether or not the user intervenes. The **source code** is in folder `/src/demo/bricks` of the SDK distribution.

- Use `osmain_sync` to start a synchronous application, indicating an interval and update *callback* function. `NAppGUI` will periodically launch time events that will update the program.

This application is managed by two events (Figure 23.2). On the one hand the slider movement, which can occur at any time (asynchronous event), and will update the player position. On the other a synchronous event produced by `osmain_sync` every 40 milliseconds and will be notified through `i_update()` to update the game state and graphic view.

Listing 23.1: `demo/bricks/bricks.c`

```
/* Simplistic Breakout-like game */  
  
#include <nappgui.h>  
  
#define NUM_BRICKS 40  
  
typedef struct _brick_t Brick;  
typedef struct _app_t App;
```

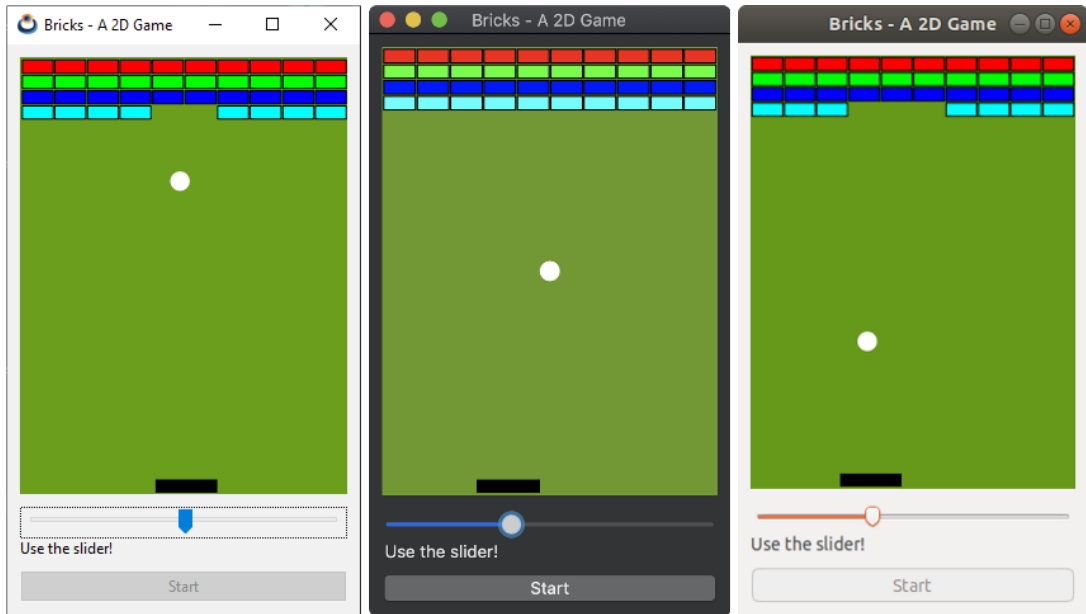



Figure 23.1: Bricks video game on Windows, macOS and Linux.

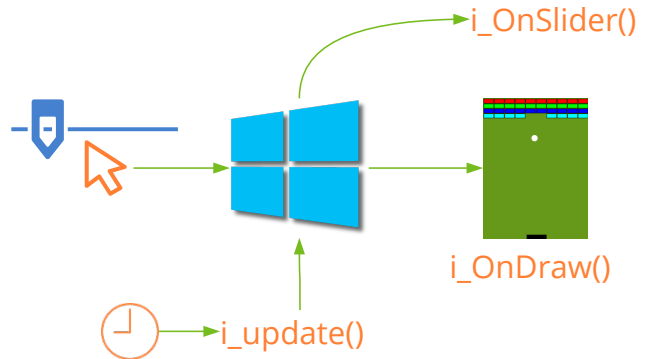

Figure 23.2: Synchronous and asynchronous events.

```

struct _brick_t
{
    real32_t x;
    real32_t y;
    uint8_t color;
    bool_t is_visible;
};

struct _app_t
{
    bool_t is_running;
    Brick bricks[NUM_BRICKS];
    color_t color[4];
};

```

```

real32_t brick_width;
real32_t player_pos;
real32_t ball_x;
real32_t ball_y;
V2Df ball_dir;
real32_t ball_speed;
Cell *button;
Slider *slider;
View *view;
Window *window;
};

/*-----*/

static const real32_t i_BALL_RADIUS = .03f;
static const real32_t i_BRICK_HEIGHT = .03f;
static const real32_t i_BRICK_SEPARATION = .005f;
static const uint32_t i_BRICKS_PER_ROW = 10;
static const uint32_t i_NUM_ROWS = 4;

/*-----*/

static void i_OnDraw(App *app, Event *e)
{
    const EvDraw *params = event_params(e, EvDraw);
    uint32_t i = 0;

    draw_clear(params->ctx, color_rgb(102, 153, 26));
    draw_line_color(params->ctx, kCOLOR_BLACK);

    for (i = 0; i < NUM_BRICKS; ++i)
    {
        if (app->bricks[i].is_visible == TRUE)
        {
            real32_t x = app->bricks[i].x * params->width;
            real32_t y = app->bricks[i].y * params->height;
            real32_t width = app->brick_width * params->width;
            real32_t height = i_BRICK_HEIGHT * params->height;
            draw_fill_color(params->ctx, app->color[app->bricks[i].color]);
            draw_rect(params->ctx, ekFILLSK, x, y, width, height);
        }
    }

    {
        real32_t x = (app->player_pos - app->brick_width) * params->width;
        real32_t y = (1 - i_BRICK_HEIGHT - i_BRICK_SEPARATION) * params->height
        ↪ ;
        real32_t width = 2 * app->brick_width * params->width;
        real32_t height = i_BRICK_HEIGHT * params->height;
        draw_fill_color(params->ctx, kCOLOR_BLACK);
        draw_rect(params->ctx, ekFILL, x, y, width, height);
    }
}

```

```

    }

    {
        real32_t x = app->ball_x * params->width;
        real32_t y = app->ball_y * params->height;
        real32_t rad = i_BALL_RADIUS * params->width;
        draw_fill_color(params->ctx, kCOLOR_WHITE);
        draw_circle(params->ctx, ekFILL, x, y, rad);
    }
}

/*-----*/

static void i_OnSlider(App *app, Event *e)
{
    const EvSlider *params = event_params(e, EvSlider);
    app->player_pos = params->pos;
}

/*-----*/

static void i_OnStart(App *app, Event *e)
{
    unref(e);
    app->is_running = TRUE;
    cell_enabled(app->button, FALSE);
}

/*-----*/

static Panel *i_panel(App *app)
{
    Panel *panel = panel_create();
    Layout *layout = layout_create(1, 4);
    View *view = view_create();
    Slider *slider = slider_create();
    Label *label = label_create();
    Button *button = button_push();
    view_size(view, s2df(258, 344));
    view_OnDraw(view, listener(app, i_OnDraw, App));
    slider_OnMoved(slider, listener(app, i_OnSlider, App));
    label_text(label, "Use the slider!");
    button_text(button, "Start");
    button_OnClick(button, listener(app, i_OnStart, App));
    layout_view(layout, view, 0, 0);
    layout_slider(layout, slider, 0, 1);
    layout_label(layout, label, 0, 2);
    layout_button(layout, button, 0, 3);
    layout_vexpand(layout, 0);
    layout_vmargn(layout, 0, 10);
    layout_vmargn(layout, 2, 10);
}

```

```

    layout_margin(layout, 10);
    panel_layout(panel, layout);
    app->view = view;
    app->slider = slider;
    app->button = layout_cell(layout, 0, 3);
    return panel;
}

/*-----*/

static void i_init_game(App *app)
{
    real32_t hoffset;
    Brick *brick = NULL;
    uint32_t j, i;

    app->color[0] = color_rgb(255, 0, 0);
    app->color[1] = color_rgb(0, 255, 0);
    app->color[2] = color_rgb(0, 0, 255);
    app->color[3] = color_rgb(0, 255, 255);

    hoffset = i_BRICK_SEPARATION;
    brick = app->bricks;

    app->is_running = FALSE;
    app->brick_width = (1 - ((real32_t)i_BRICKS_PER_ROW + 1) *
        ↪ i_BRICK_SEPARATION) / (real32_t)i_BRICKS_PER_ROW;

    for (j = 0; j < i_NUM_ROWS; ++j)
    {
        real32_t woffset = i_BRICK_SEPARATION;

        for (i = 0; i < i_BRICKS_PER_ROW; ++i)
        {
            brick->x = woffset;
            brick->y = hoffset;
            brick->is_visible = TRUE;
            brick->color = (uint8_t)j;
            woffset += app->brick_width + i_BRICK_SEPARATION;
            brick++;
        }

        hoffset += i_BRICK_HEIGHT + i_BRICK_SEPARATION;
    }

    app->player_pos = slider_get_value(app->slider);
    app->ball_x = .5f;
    app->ball_y = .5f;
    app->ball_dir.x = .3f;
    app->ball_dir.y = -.1f;
    app->ball_speed = .6f;
}

```

```

    v2d_normf(&app->ball_dir);
}

/*-----*/

static void i_OnClose(App *app, Event *e)
{
    osapp_finish();
    unref(app);
    unref(e);
}

/*-----*/

static App *i_create(void)
{
    App *app = heap_new0(App);
    Panel *panel = i_panel(app);
    app->window = window_create(ekWINDOW_STDRES);
    window_panel(app->window, panel);
    window_origin(app->window, v2df(200, 200));
    window_title(app->window, "Bricks - A 2D Game");
    window_OnClose(app->window, listener(app, i_OnClose, App));
    window_show(app->window);
    i_init_game(app);
    return app;
}

/*-----*/

static void i_destroy(App **app)
{
    window_destroy(&(*app)->window);
    heap_delete(app, App);
}

/*-----*/

static bool_t i_collision(Brick *brick, real32_t brick_width, real32_t ball_x,
    ↪ real32_t ball_y)
{
    if (ball_x + i_BALL_RADIUS < brick->x)
        return FALSE;
    if (ball_x - i_BALL_RADIUS > brick->x + brick_width)
        return FALSE;
    if (ball_y + i_BALL_RADIUS < brick->y)
        return FALSE;
    if (ball_y - i_BALL_RADIUS > brick->y + i_BRICK_HEIGHT)
        return FALSE;
    return TRUE;
}

```

```

/*-----*/

static void i_update(App *app, const real64_t ptime, const real64_t ctime)
{
    if (app->is_running == TRUE)
    {
        real32_t step = (real32_t)(ctime - ptime);
        bool_t collide;
        uint32_t i;

        /* Update ball position */
        app->ball_x += step * app->ball_speed * app->ball_dir.x;
        app->ball_y += step * app->ball_speed * app->ball_dir.y;

        /* Collision with limits */
        if (app->ball_x + i_BALL_RADIUS >= 1.f && app->ball_dir.x >= 0.f)
            app->ball_dir.x = - app->ball_dir.x;

        if (app->ball_x - i_BALL_RADIUS <= 0.f && app->ball_dir.x <= 0.f)
            app->ball_dir.x = - app->ball_dir.x;

        if (app->ball_y - i_BALL_RADIUS <= 0.f && app->ball_dir.y <= 0.f)
            app->ball_dir.y = - app->ball_dir.y;

        /* Collision with bricks */
        collide = FALSE;
        for (i = 0; i < NUM_BRICKS; ++i)
        {
            if (app->bricks[i].is_visible == TRUE)
            {
                if (i_collision(&app->bricks[i], app->brick_width, app->ball_x,
                    ↪ app->ball_y) == TRUE)
                {
                    app->bricks[i].is_visible = FALSE;
                    if (collide == FALSE)
                    {
                        real32_t brick_x = app->bricks[i].x + .5f * app->
                            ↪ brick_width;
                        app->ball_dir.x = 5.f * (app->ball_x - brick_x);
                        app->ball_dir.y = - app->ball_dir.y;
                        v2d_normf(&app->ball_dir);
                        collide = TRUE;
                    }
                }
            }
        }

        /* Collision with player */
        {
            Brick player;

```

```

    player.x = app->player_pos - app->brick_width;
    player.y = 1.f - i_BRICK_HEIGHT - i_BRICK_SEPARATION;
    if (i_collision(&player, 2.f * app->brick_width, app->ball_x, app->
        ↵ ball_y) == TRUE)
    {
        app->ball_dir.x = 5.f * (app->ball_x - app->player_pos);
        app->ball_dir.y = - app->ball_dir.y;
        v2d_normf(&app->ball_dir);
    }
}

/* Game Over */
if (app->ball_y + i_BALL_RADIUS >= 1.f)
{
    i_init_game(app);
    cell_enabled(app->button, TRUE);
}

view_update(app->view);
}

/*-----*/

#include "osmain.h"
osmain_sync(.04, i_create, i_destroy, i_update, "", App)

```

Fractals

24.1 Fractals

447

24.1. Fractals

In this application we create an procedural image by calculating the color of each pixel using fractal algorithms (Figure 24.1). Some of the most fascinating results produced by a dynamic system occur when we iterate a complex variable function instead of a real one. This is the case of **Julia's sets**. The **source code** is in folder `/src/demo/fractals` of the SDK distribution.

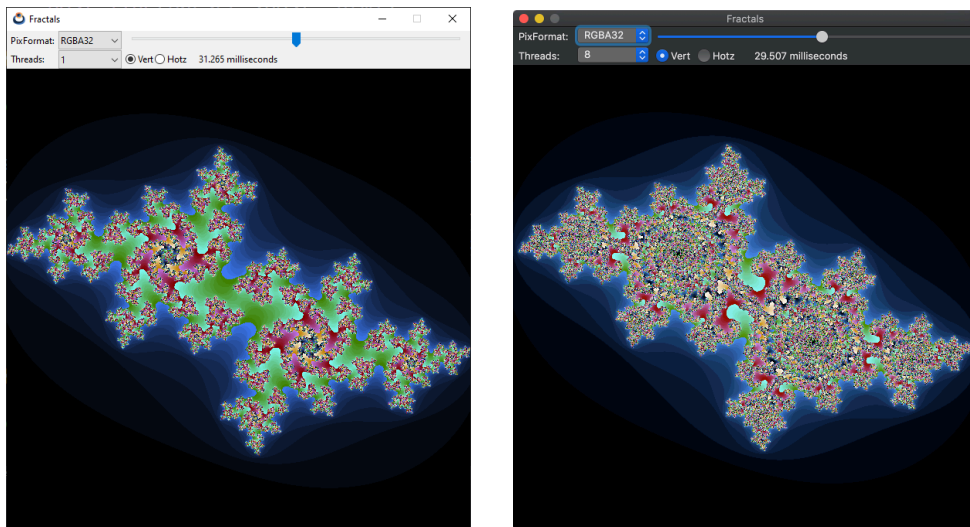

Figure 24.1: Fractals application Windows and macOS version.

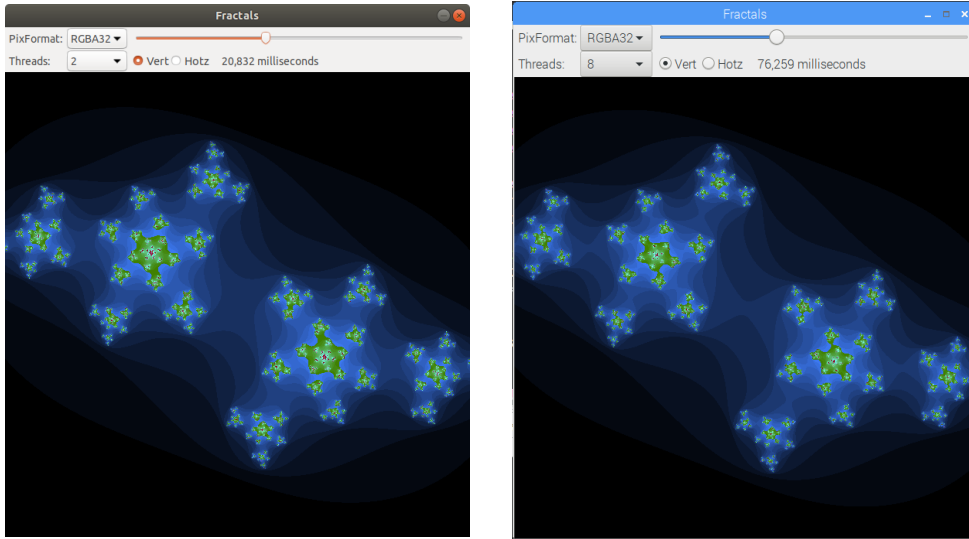

Figure 24.2: Ubuntu and Raspbian version.

Due to the large computational load of this algorithm we have divided the calculation into several threads (Figure 24.3). This problem is easily parallelizable simply by fractioning the image, because each pixel is obtained independently.

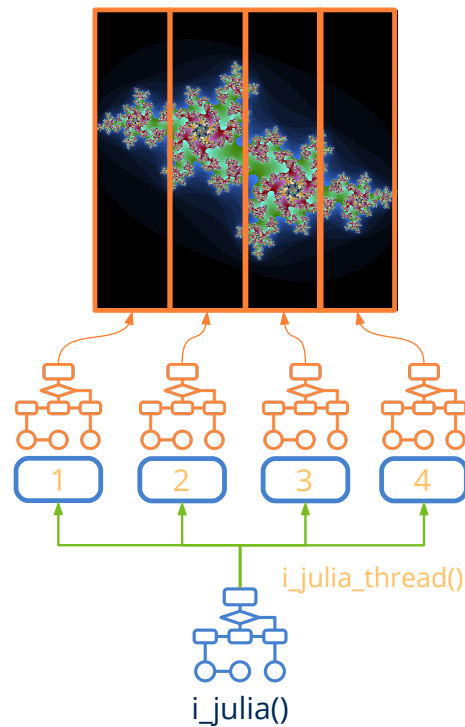

Figure 24.3: Collaboration of several threads.

Listing 24.1: demo/fractals/fractals.c

```

/* Multi-threaded fractals */

#include <nappgui.h>

typedef struct _app_t App;
typedef struct _thdata_t ThData;

struct _app_t
{
    Window *window;
    ImageView *view;
    Label *time_label;
    Clock *clock;
    uint32_t threads;
    bool_t vertical;
    real64_t fct;
};

struct _thdata_t
{
    real64_t fct;
    real64_t kreal;
    real64_t kimag;
    Pixbuf *pixbuf;
    uint32_t i;
    uint32_t j;
    uint32_t width;
    uint32_t height;
};

static const real64_t i_FCT = 2.85;
static const uint32_t i_ITERATIONS = 512;
static const uint32_t i_WIDTH = 601;
static const uint32_t i_HEIGHT = 601;

/*-----*/

static uint32_t i_inset(real64_t zreal, real64_t zimag, real64_t creal,
    ↪ real64_t cimag)
{
    uint32_t i;
    for(i = 0; i < i_ITERATIONS; ++i)
    {
        real64_t ztmp, zdist;
        ztmp = zreal * zreal - zimag * zimag;
        zimag = zreal * zimag + zreal * zimag;
        zreal = ztmp;
        zreal = zreal + creal;
        zimag = zimag + cimag;
        zdist = zimag * zimag + zreal * zreal;
    }
}

```

```

        if (zdist > 3)
            return i;
    }

    return 0;
}

/*-----*/

static uint32_t i_julia_thread(ThData *data)
{
    real64_t fct = data->fct;
    uint32_t imgwidth = pixbuf_width(data->pixbuf);
    real64_t freal = fct / imgwidth;
    real64_t fimag = fct / pixbuf_height(data->pixbuf);
    real64_t kreal = data->kreal;
    real64_t kimag = data->kimag;
    uint32_t val;
    real64_t creal, cimag;
    uint32_t stj = data->j;
    uint32_t edj = data->j + data->height;
    uint32_t sti = data->i;
    uint32_t edi = data->i + data->width;
    uint32_t i, j;

    for(j = stj; j < edj; ++j)
    {
        cimag = fimag * j - (fct / 2);

        for(i = sti; i < edi; ++i)
        {
            creal = freal * i - (fct / 2);
            val = i_inset(creal, cimag, kreal, kimag);
            if (val > 0)
            {
                uint8_t n_val = (uint8_t)(val % 255);
                if ( val < ( i_ITERATIONS >> 1 ) )
                    val = color_rgb((uint8_t)(n_val << 2), (uint8_t)(n_val <<
                    ↪ 3), (uint8_t)(n_val << 4));
                else
                    val = color_rgb((uint8_t)(n_val << 4), (uint8_t)(n_val <<
                    ↪ 2), (uint8_t)(n_val << 5));
            }
            else
            {
                val = kCOLOR_BLACK;
            }

            pixbuf_set(data->pixbuf, i, j, val);
        }
    }
}

```

```

    return 5;
}

/*-----*/

static void i_julia(const uint32_t nthreads, const bool_t vertical, const
    ↪ real64_t fct, const real64_t kreal, const real64_t kimag, Pixbuf *pixbuf
    ↪ )
{
    ThData data[8];
    uint32_t width = pixbuf_width(pixbuf);
    uint32_t height = pixbuf_height(pixbuf);
    data[0].fct = fct;
    data[0].kreal = kreal;
    data[0].kimag = kimag;
    data[0].pixbuf = pixbuf;

    if (nthreads == 1)
    {
        data[0].i = 0;
        data[0].j = 0;
        data[0].width = width;
        data[0].height = height;
        i_julia_thread(&data[0]);
    }
    else
    {
        Thread *thread[8];

        uint32_t i;
        if (vertical == TRUE)
        {
            uint32_t twidth = width / nthreads;
            for (i = 0; i < nthreads; ++i)
            {
                data[i] = data[0];
                data[i].i = i * twidth;
                data[i].j = 0;
                data[i].width = twidth;
                data[i].height = height;
            }

            data[nthreads-1].width += (width - (twidth * nthreads));
        }
        else
        {
            uint32_t theight = height / nthreads;
            for (i = 0; i < nthreads; ++i)
            {
                data[i] = data[0];

```

```

        data[i].i = 0;
        data[i].j = i * theight;
        data[i].width = width;
        data[i].height = theight;
    }

    data[nthreads-1].height += (height - (theight * nthreads));
}

for (i = 0; i < nthreads; ++i)
    thread[i] = bthread_create(i_julia_thread, &data[i], ThData);

for (i = 0; i < nthreads; ++i)
{
    uint32_t thid = bthread_wait(thread[i]);
    cassert_unref(thid == 5, thid);
    bthread_close(&thread[i]);
}
}

/*-----*/

static void i_image(App *app)
{
    Pixbuf *pixbuf = pixbuf_create(i_WIDTH, i_HEIGHT, ekRGBA32);
    real64_t rfactor = app->fct / i_WIDTH;
    real64_t ifactor = app->fct / i_HEIGHT;
    real64_t kreal = rfactor * 307 - 2;
    real64_t kimag = ifactor * 184 - 1.4;
    Image *image = NULL;
    real64_t timems;
    String *str;
    clock_reset(app->clock);
    i_julia(app->threads, app->vertical, app->fct, kreal, kimag, pixbuf);
    timems = 1000. * clock_elapsed(app->clock);
    str = str_printf("%.3f milliseconds", timems);
    label_text(app->time_label, tc(str));
    str_destroy(&str);
    image = image_from_pixbuf(pixbuf, NULL);
    imageview_image(app->view, image);
    image_destroy(&image);
    pixbuf_destroy(&pixbuf);
}

/*-----*/

static void i_OnSlider(App *app, Event *e)
{
    const EvSlider *p = event_params(e, EvSlider);
    real64_t st = i_FCT - 1;

```

```

    real64_t ed = i_FCT + 1;
    app->fct = ((ed - st) * p->pos) + st;
    i_image(app);
}

/*-----*/

static void i_OnThreads(App *app, Event *e)
{
    const EvButton *p = event_params(e, EvButton);
    switch(p->index) {
        case 0: app->threads = 1; break;
        case 1: app->threads = 2; break;
        case 2: app->threads = 3; break;
        case 3: app->threads = 4; break;
        case 4: app->threads = 8; break; }
    i_image(app);
}

/*-----*/

static void i_OnVertical(App *app, Event *e)
{
    const EvButton *p = event_params(e, EvButton);
    app->vertical = p->index == 0 ? TRUE : FALSE;
    i_image(app);
}

/*-----*/

static Panel *i_panel(App *app)
{
    Panel *panel = panel_create();
    Layout *layout1 = layout_create(1, 3);
    Layout *layout2 = layout_create(5, 1);
    Label *labell1 = label_create();
    Label *labell2 = label_create();
    PopUp *popup = popup_create();
    Slider *slider = slider_create();
    Button *button1 = button_radio();
    Button *button2 = button_radio();
    ImageView *view = imageview_create();
    label_text(labell1, "Threads:");
    popup_add_elem(popup, "1", NULL);
    popup_add_elem(popup, "2", NULL);
    popup_add_elem(popup, "3", NULL);
    popup_add_elem(popup, "4", NULL);
    popup_add_elem(popup, "8", NULL);
    popup_selected(popup, 0);
    popup_OnSelect(popup, listener(app, i_OnThreads, App));
    slider_value(slider, .5f);
}

```

```

slider_OnMoved(slider, listener(app, i_OnSlider, App));
button_text(button1, "Vert");
button_text(button2, "Hotz");
button_state(button1, ekGUI_ON);
button_OnClick(button1, listener(app, i_OnVertical, App));
imageview_size(view, s2di(i_WIDTH, i_HEIGHT));
layout_slider(layout1, slider, 0, 0);
layout_label(layout2, label1, 0, 0);
layout_popup(layout2, popup, 1, 0);
layout_button(layout2, button1, 2, 0);
layout_button(layout2, button2, 3, 0);
layout_label(layout2, label2, 4, 0);
layout_halign(layout2, 4, 0, ekJUSTIFY);
layout_hexexpand(layout2, 4);
layout_layout(layout1, layout2, 0, 1);
layout_imageview(layout1, view, 0, 2);
layout_vmargint(layout1, 1, 5);
layout_margin2(layout2, 0, 5);
layout_hmargin(layout2, 0, 5);
layout_hmargin(layout2, 1, 10);
layout_hmargin(layout2, 2, 5);
layout_hmargin(layout2, 3, 15);
panel_layout(panel, layout1);
app->fct = i_FCT;
app->threads = 1;
app->vertical = TRUE;
app->view = view;
app->time_label = label2;
return panel;
}

/*-----*/

static void i_OnClose(App *app, Event *e)
{
    osapp_finish();
    unref(app);
    unref(e);
}

/*-----*/

static App *i_create(void)
{
    App *app = heap_new0(App);
    Panel *panel = i_panel(app);
    app->window = window_create(ekWINDOW_STD);
    app->clock = clock_create(0);
    i_image(app);
    window_panel(app->window, panel);
    window_title(app->window, "Fractals");
}

```

```
    window_origin(app->window, v2df(500, 200));
    window_OnClose(app->window, listener(app, i_OnClose, App));
    window_show(app->window);
    return app;
}

/*-----*/

static void i_destroy(App **app)
{
    window_destroy(&(*app)->window);
    clock_destroy(&(*app)->clock);
    heap_delete(app, App);
}

/*-----*/

#include "osmain.h"
osmain(i_create, i_destroy, "", App)
```

Bode

25.1 Bode

457

25.1. Bode

In this project we approach the construction of an interactive user interface for **Bode Plots**, a tool widely used in Control Engineering (Figure 25.1). The calculus module has been written in C language by Javier Gil Chica¹, Phd of Physics Department of the University of Alicante. The complete source code is available in folder `/src/demo/bode` of the SDK distribution.

The main window has been divided vertically into two parts, using a `layout(2,1)` (Figure 25.4). On the left side we have the parameters `P`, `Q`, `T`, `R` and some buttons. Sublayouts have been used `i_coeffs(4,9)` and `i_ranges(3,3)` to group controls. In the right area are two `View` drawing controls for graphics and other sublayout `i_sliders(3,3)` with the parameters `I`, `P`, `D`.

The horizontal resizing is done entirely on the right cell (graphs and sliders), keeping the parameter area a constant horizontal size. During the vertical resizing the graphs will grow with a proportion of 50% each. For the left part, an empty cell has been reserved, which will expand horizontally, aligning the button `[More Info]` to the bottom edge of the window.

Listing 25.1: `demo/bode/bdview.c`

```
/* Bode View */  
  
#include "bdview.h"
```

¹<mailto:francisco.gil@ua.es>

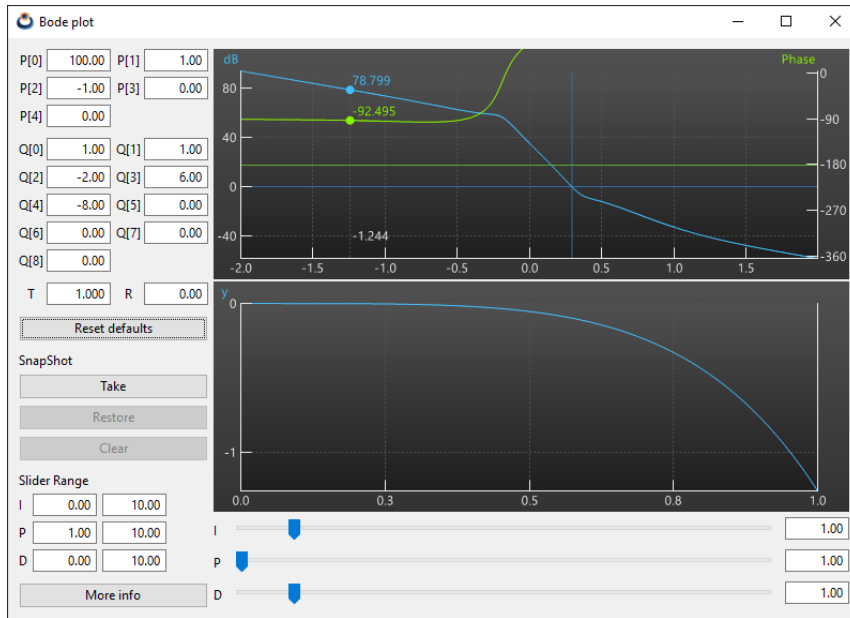

Figure 25.1: Windows version.

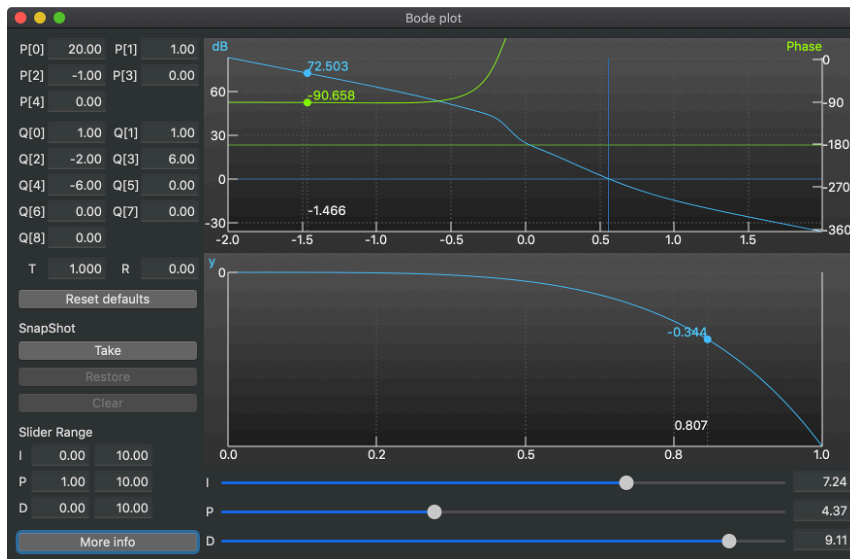

Figure 25.2: macOS version.

```
#include "bdctrl.h"
#include <gui/guiall.h>

static const real32_t kEDIT_WIDTH = 60;
```

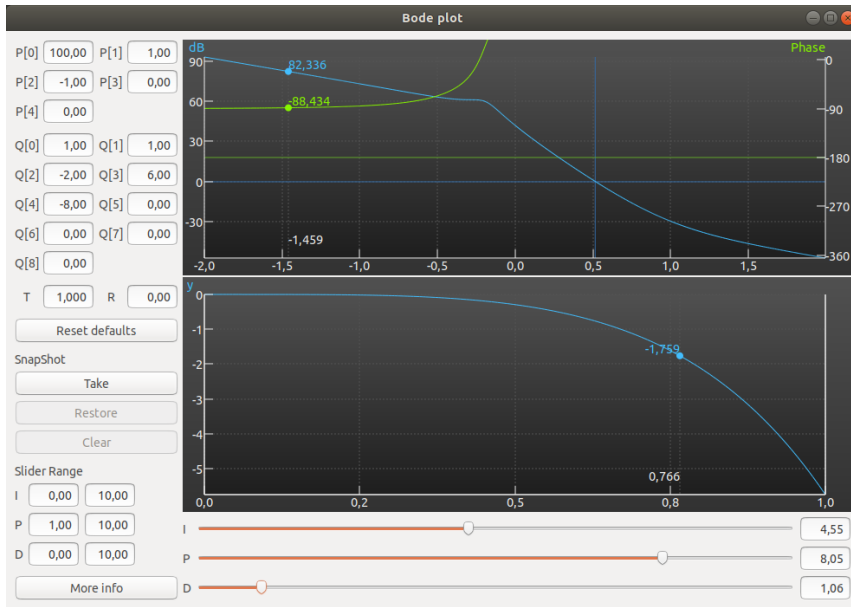

Figure 25.3: Ubuntu version.

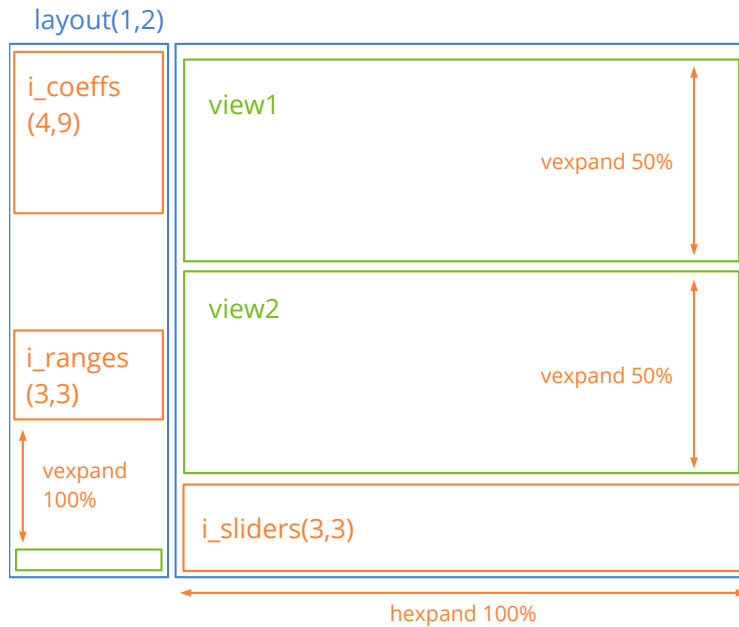

Figure 25.4: Bode user interface distribution.

```

static Cell *i_coeff(Layout *layout, const char_t *text, const uint32_t col,
    ↪ const uint32_t row)
{
    Label *label = label_create();
    Edit *edit = edit_create();
    label_text(label, text);
    edit_align(edit, ekRIGHT);
    layout_halign(layout, col * 2, row, ekCENTER);
    layout_label(layout, label, col * 2, row);
    layout_edit(layout, edit, col * 2 + 1, row);
    return layout_cell(layout, col * 2 + 1, row);
}

/*-----*/

static Layout *i_coeffs(void)
{
    Layout *layout = layout_create(4, 9);
    cell_dbind(i_coeff(layout, "P[0]", 0, 0), Params, real32_t, P[0]);
    cell_dbind(i_coeff(layout, "P[1]", 1, 0), Params, real32_t, P[1]);
    cell_dbind(i_coeff(layout, "P[2]", 0, 1), Params, real32_t, P[2]);
    cell_dbind(i_coeff(layout, "P[3]", 1, 1), Params, real32_t, P[3]);
    cell_dbind(i_coeff(layout, "P[4]", 0, 2), Params, real32_t, P[4]);
    cell_dbind(i_coeff(layout, "Q[0]", 0, 3), Params, real32_t, Q[0]);
    cell_dbind(i_coeff(layout, "Q[1]", 1, 3), Params, real32_t, Q[1]);
    cell_dbind(i_coeff(layout, "Q[2]", 0, 4), Params, real32_t, Q[2]);
    cell_dbind(i_coeff(layout, "Q[3]", 1, 4), Params, real32_t, Q[3]);
    cell_dbind(i_coeff(layout, "Q[4]", 0, 5), Params, real32_t, Q[4]);
    cell_dbind(i_coeff(layout, "Q[5]", 1, 5), Params, real32_t, Q[5]);
    cell_dbind(i_coeff(layout, "Q[6]", 0, 6), Params, real32_t, Q[6]);
    cell_dbind(i_coeff(layout, "Q[7]", 1, 6), Params, real32_t, Q[7]);
    cell_dbind(i_coeff(layout, "Q[8]", 0, 7), Params, real32_t, Q[8]);
    cell_dbind(i_coeff(layout, "T", 0, 8), Params, real32_t, T);
    cell_dbind(i_coeff(layout, "R", 1, 8), Params, real32_t, R);
    layout_hsize(layout, 1, kEDIT_WIDTH);
    layout_hsize(layout, 3, kEDIT_WIDTH);
    layout_vmargin(layout, 0, 5);
    layout_vmargin(layout, 1, 5);
    layout_vmargin(layout, 2, 10);
    layout_vmargin(layout, 3, 5);
    layout_vmargin(layout, 4, 5);
    layout_vmargin(layout, 5, 5);
    layout_vmargin(layout, 6, 5);
    layout_vmargin(layout, 7, 10);
    layout_hmargin(layout, 1, 5);
    layout_hmargin(layout, 0, 3);
    layout_hmargin(layout, 2, 3);
    return layout;
}

/*-----*/

```

```

static void i_range(Layout *layout, const char_t *text, const uint32_t i)
{
    Label *label = label_create();
    Edit *edit1 = edit_create();
    Edit *edit2 = edit_create();
    label_text(label, text);
    edit_align(edit1, ekRIGHT);
    edit_align(edit2, ekRIGHT);
    layout_label(layout, label, 0, i);
    layout_edit(layout, edit1, 1, i);
    layout_edit(layout, edit2, 2, i);
}

/*-----*/

static Layout *i_ranges(void)
{
    Layout *layout = layout_create(3, 3);
    i_range(layout, "I", 0);
    i_range(layout, "P", 1);
    i_range(layout, "D", 2);
    layout_hsize(layout, 1, kEDIT_WIDTH);
    layout_hsize(layout, 2, kEDIT_WIDTH);
    layout_vmargin(layout, 0, 5);
    layout_vmargin(layout, 1, 5);
    layout_hmargin(layout, 0, 5);
    layout_hmargin(layout, 1, 5);
    cell_dbind(layout_cell(layout, 1, 0), Params, real32_t, KRg[0]);
    cell_dbind(layout_cell(layout, 2, 0), Params, real32_t, KRg[1]);
    cell_dbind(layout_cell(layout, 1, 1), Params, real32_t, KRg[2]);
    cell_dbind(layout_cell(layout, 2, 1), Params, real32_t, KRg[3]);
    cell_dbind(layout_cell(layout, 1, 2), Params, real32_t, KRg[4]);
    cell_dbind(layout_cell(layout, 2, 2), Params, real32_t, KRg[5]);
    return layout;
}

/*-----*/

static Layout *i_left(Ctrl *ctrl)
{
    Layout *layout = layout_create(1, 10);
    Layout *layout1 = i_coeffs();
    Button *button = button_push();
    Label *label = label_create();
    Button *button2 = button_push();
    Button *button3 = button_push();
    Button *button4 = button_push();
    Label *label2 = label_create();
    Layout *layout2 = i_ranges();
    Button *button5 = button_push();
}

```

```

    button_text(button, "Reset defaults");
    button_text(button2, "Take");
    button_text(button3, "Restore");
    button_text(button4, "Clear");
    button_text(button5, "More info");
    label_text(label, "SnapShot");
    label_text(label2, "Slider Range");
    layout_layout(layout, layout1, 0, 0);
    layout_button(layout, button, 0, 1);
    layout_label(layout, label, 0, 2);
    layout_button(layout, button2, 0, 3);
    layout_button(layout, button3, 0, 4);
    layout_button(layout, button4, 0, 5);
    layout_label(layout, label2, 0, 6);
    layout_layout(layout, layout2, 0, 7);
    layout_button(layout, button5, 0, 9);
    layout_halign(layout, 0, 7, ekLEFT);
    layout_vmargin(layout, 0, 10);
    layout_vmargin(layout, 1, 10);
    layout_vmargin(layout, 2, 5);
    layout_vmargin(layout, 3, 5);
    layout_vmargin(layout, 4, 5);
    layout_vmargin(layout, 5, 10);
    layout_vmargin(layout, 6, 5);
    layout_vmargin(layout, 7, 10);
    layout_vexpand(layout, 8);
    ctrl_reset(ctrl, button);
    ctrl_take(ctrl, layout_cell(layout, 0, 3));
    ctrl_restore(ctrl, layout_cell(layout, 0, 4));
    ctrl_clear(ctrl, layout_cell(layout, 0, 5));
    ctrl_info(ctrl, button5);
    return layout;
}

/*-----*/

static void i_slider_K(Layout *layout, const char_t *title, const uint32_t row)
{
    Label *label = label_create();
    Slider* slider = slider_create();
    Edit* edit = edit_create();
    label_text(label, title);
    edit_align(edit, ekRIGHT);
    layout_label(layout, label, 0, row);
    layout_slider(layout, slider, 1, row);
    layout_edit(layout, edit, 2, row);
}

/*-----*/

static Layout *i_sliders(Ctrl *ctrl)

```

```

{
    Layout *layout = layout_create(3, 3);
    i_slider_K(layout, "I", 0);
    i_slider_K(layout, "P", 1);
    i_slider_K(layout, "D", 2);
    layout_hsize(layout, 2, kEDIT_WIDTH);
    layout_vmargn(layout, 0, 5);
    layout_vmargn(layout, 1, 5);
    layout_hmargn(layout, 0, 5);
    layout_hmargn(layout, 1, 5);
    layout_hexpand(layout, 1);
    cell_dbind(layout_cell(layout, 1, 0), Params, real32_t, K[0]);
    cell_dbind(layout_cell(layout, 2, 0), Params, real32_t, K[0]);
    cell_dbind(layout_cell(layout, 1, 1), Params, real32_t, K[1]);
    cell_dbind(layout_cell(layout, 2, 1), Params, real32_t, K[1]);
    cell_dbind(layout_cell(layout, 1, 2), Params, real32_t, K[2]);
    cell_dbind(layout_cell(layout, 2, 2), Params, real32_t, K[2]);
    ctrl_slider1(ctrl, layout_cell(layout, 1, 0));
    return layout;
}

/*-----*/

static Layout* i_right(Ctrl *ctrl)
{
    Layout *layout = layout_create(1, 3);
    Layout* layout1 = i_sliders(ctrl);
    View* view1 = view_create();
    View* view2 = view_create();
    layout_view(layout, view1, 0, 0);
    layout_view(layout, view2, 0, 1);
    layout_layout(layout, layout1, 0, 2);
    layout_vmargn(layout, 0, 2);
    layout_vmargn(layout, 1, 5);
    layout_vexpand2(layout, 0, 1, .5f);
    ctrl_view1(ctrl, view1);
    ctrl_view2(ctrl, view2);
    return layout;
}

/*-----*/

static Panel *i_panel(Ctrl *ctrl)
{
    Panel *panel = panel_create();
    Layout *layout = layout_create(2, 1);
    Layout *layout1 = i_left(ctrl);
    Layout *layout2 = i_right(ctrl);
    layout_layout(layout, layout1, 0, 0);
    layout_layout(layout, layout2, 1, 0);
    layout_hmargn(layout, 0, 5);
}

```



```
    layout_hexexpand(layout, 1);
    layout_margin(layout, 10);
    panel_layout(panel, layout);
    layout_dbind(layout1, NULL, Params);
    layout_dbind(layout2, NULL, Params);
    cell_dbind(layout_cell(layout, 0, 0), Model, Params, cparams);
    cell_dbind(layout_cell(layout, 1, 0), Model, Params, cparams);
    layout_dbind(layout, listener(ctrl, ctrl_OnModelChange, Ctrl), Model);
    ctrl_layout(ctrl, layout);
    return panel;
}

/*-----*/

Window* bdview_create(Ctrl *ctrl)
{
    Panel *panel = i_panel(ctrl);
    Window *window = window_create(ekWINDOW_STDRES);
    window_panel(window, panel);
    window_title(window, "Bode plot");
    return window;
}
```

Products

26.1	Products	465
26.2	Specifications	467
26.3	Model-View-Controller	468
26.4	Model	468
26.4.1	JSON WebServices	469
26.4.2	Write/Read on disk	471
26.4.3	Add/Delete records	472
26.5	View	473
26.5.1	Multi-layout panel	474
26.5.2	Hide columns	475
26.5.3	Bar graphs	476
26.5.4	Translations	477
26.5.5	<i>Dark Mode</i> themes	478
26.6	Controller	479
26.6.1	Multi-threaded login	480
26.6.2	Synchronize Model and View	481
26.6.3	Change the image	483
26.6.4	Memory management	484
26.7	The complete program	485

26.1. Products

In this project we will face the construction of an application that allows browsing through a database of products obtained from a Web server (Figure 26.1). This client-server pattern is widely used today, so we will have a stable base to create any application

based on this model. The **source code** is in folder `/src/demo/products` of the SDK distribution.

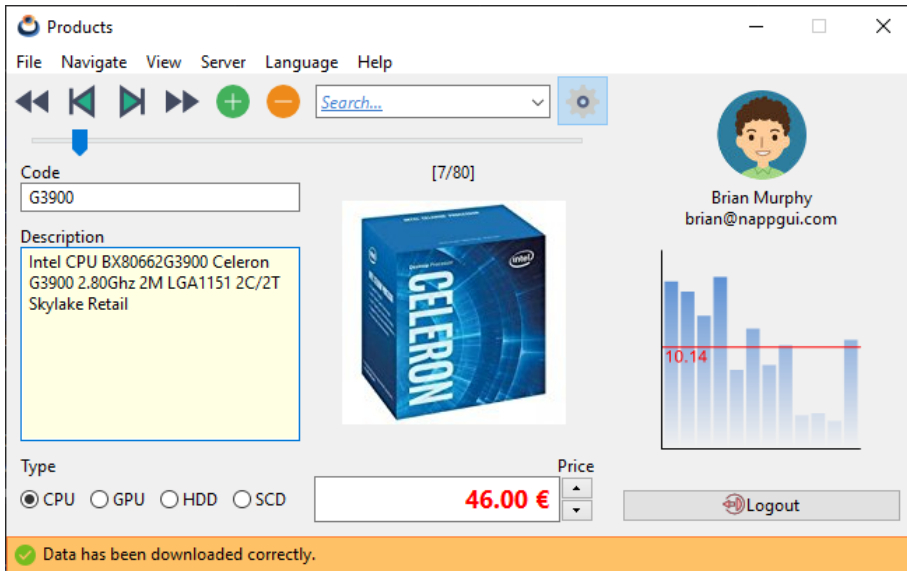

Figure 26.1: Application *Products*, Windows version.

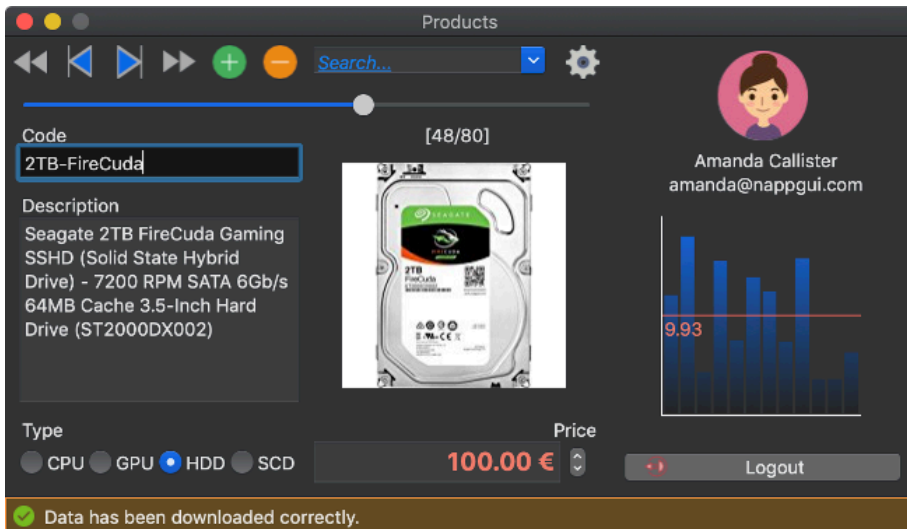

Figure 26.2: macOS version.

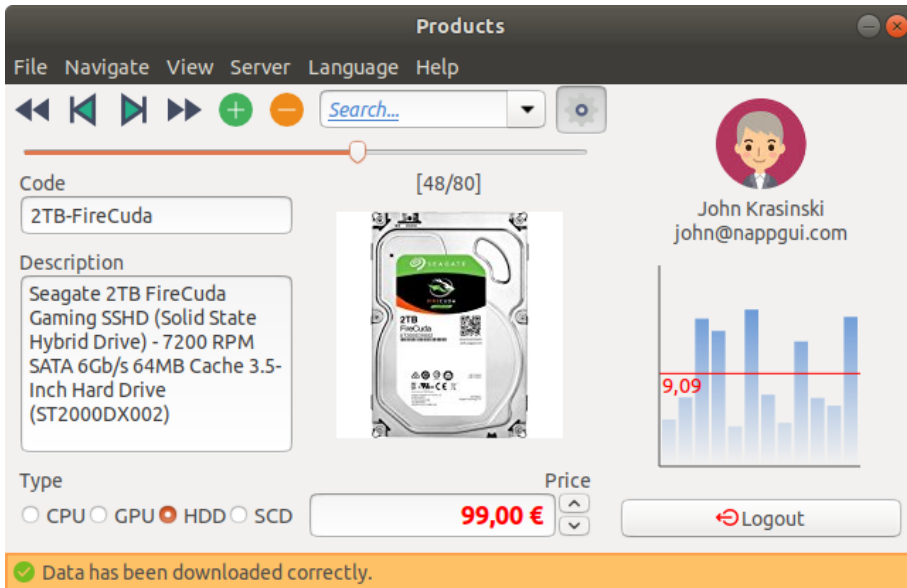

Figure 26.3: Linux/GTK+ version.

26.2. Specifications

- The database is remote and we will access it through Web services that will encapsulate the data in JSON. To obtain the products we will use this service¹ and to register a user this other². We have four **users** registered in our database: *amanda*, *brenda*, *brian* and *john* all with **password** 1234.
- The remote database is read-only. We do not have web services to edit it.
- The moment a user registers, all articles will automatically be downloaded.
- A small graph with the sales statistics of each product will be displayed.
- You can edit the database locally, as well as add or delete records.
- You can export the local database to disk, as well as import it.
- We will have the typical navigation controls: First, last, next, previous.
- We can establish a filter by description. Only those products whose description matches partially with the filter will be displayed.
- The interface will be in seven languages: English, Spanish, Portuguese, Italian, Vietnamese, Russian and Japanese. We can change the language without closing the

¹<http://serv.nappgui.com/dproducts.php>

²<http://serv.nappgui.com/duser.php?user=amanda&pass=1234>

application.

- The application must run on Windows, macOS and Linux.

26.3. Model-View-Controller

Since this program has a medium level of complexity, we will fragment it into three parts using the well-known pattern model-view-controller **MVC** (Figure 26.4).

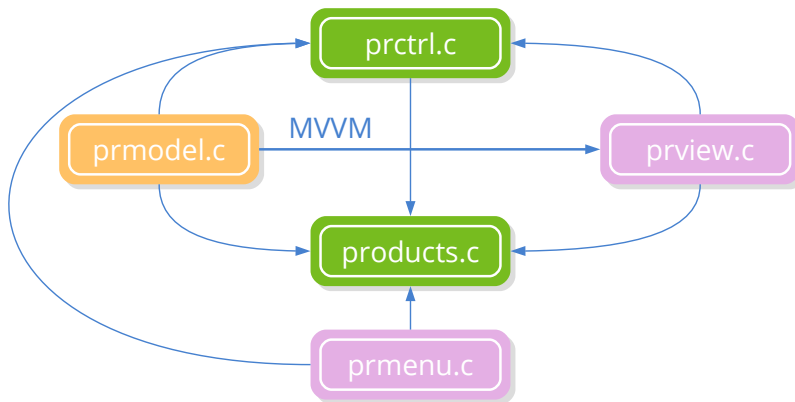

Figure 26.4: MVC modules that make up the application.

- **Model:** It will deal with the data itself, the connection with the server and the reading/writing on disk. It will be implemented in `prmodel.c`.
- **View:** Here we will implement the data presentation layer, composed of the main window (in `prview.c`) and the menu bar (in `prmenu.c`).
- **Controller:** Will take care of the logic of the program `prctrl.c`. It will respond to user events and maintain consistency between the model and the view. Due to the amount of extra work involved in synchronizing each field of the structure with the interface controls, we will use the pattern *Model-View-ViewModel* **MVVM** where the model data will be automatically synchronized with the interface and the I/O channels.
- **Main:** module `products.c`. It contains the function `osmain` and load the three previous actors.

26.4. Model

The data model of this application is quite simple (Listing 26.1), since it only requires manipulating an array of structures of type `Product`.

Listing 26.1: Structures that make up the data model.

```

typedef struct _model_t Model;
typedef struct _product_t Product;

typedef enum _type_t
{
    ekCPU,
    ekGPU,
    ekHDD,
    ekSCD
} type_t;

struct _product_t
{
    type_t type;
    String *code;
    String *description;
    Image *image64;
    real32_t price;
};

struct _model_t
{
    ArrSt(uint32_t) *filter;
    ArrPt(Product) *products;
};

```

As a previous step, we will register the model structures which will allow us to automate I/O tasks without having to explicitly coding them thanks to “*Data binding*” (page 233) (Listing 26.2).

Listing 26.2: Registration of data model struct fields.

```

dbind_enum(type_t, ekCPU);
dbind_enum(type_t, ekGPU);
dbind_enum(type_t, ekHDD);
dbind_enum(type_t, ekSCD);
dbind(Product, type_t, type);
dbind(Product, String*, code);
dbind(Product, String*, description);
dbind(Product, Image*, image64);
dbind(Product, real32_t, price);

```

26.4.1. JSON WebServices

We will get the articles data from the Web server in two steps. On the one hand we will download a `Stream` with the JSON using HTTP and, later, we will parse it to a C object (Listing 26.3).

Listing 26.3: JSON data download and processing.

```

wserv_t model_webserv(Model *model)
{
    Stream *stm = http_dget("serv.nappgui.com", 80, "/dproducts.php", NULL);
    if (stm != NULL)
    {
        PJson *jjson = json_read(stm, NULL, PJson);
        stm_close(&stm);
        ...
    }
}

```

The JSON of this web service³ consists of a header and a list of products (Listing 26.4), so we must register a new structure in order to `json_read` can create the object correctly (Listing 26.5). Note that JSON-C pairing is carried out by the field name, so these must be identical (Figure 26.5).

Listing 26.4: Web service format.

```

{
    "code":0,
    "size":80,
    "data":[
        {"id":0,
         "code":"i7-8700K",
         "description":"Intel BX80684I78700K 8th Gen Core i7-8700K Processor",
         "type":0,
         "price":374.8899999999999863575794734060764312744140625,
         "image":"cpu_00.jpg",
         "image64":"\\9j\\4AAQSkZJRgABAQ....
        },
        ...
    ]
}

```

Listing 26.5: JSON header registration.

```

typedef struct _pjson_t PJson;
struct _pjson_t
{
    int32_t code;
    uint32_t size;
    ArrPt(Product) *data;
};

dbind(PJson, int32_t, code);
dbind(PJson, uint32_t, size);
dbind(PJson, ArrPt(Product)*, data);

```

³<http://serv.nappgui.com/dproducts.php>

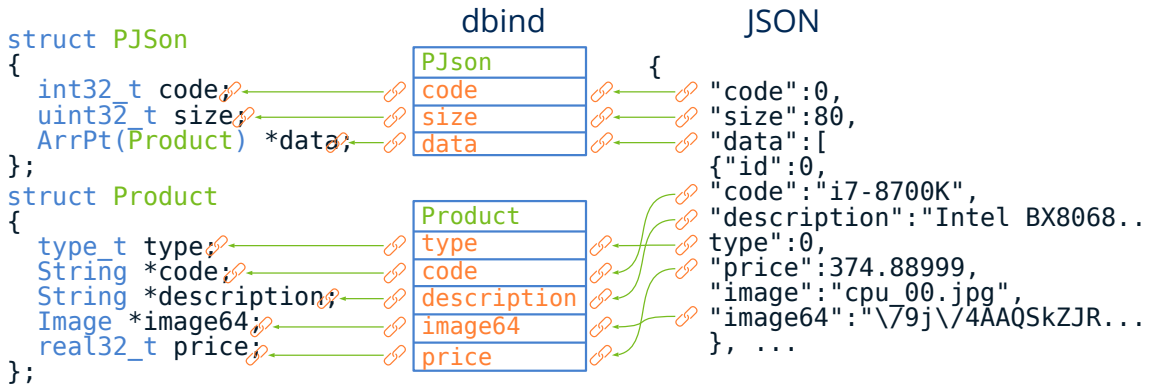

Figure 26.5: `json_read` access `dbind` registry to create a C object from a JSON stream.

26.4.2. Write/Read on disk

Serialization (Listing 26.6) and de-serialization (Listing 26.7) of objects using binary streams can also be performed automatically simply by registering the data types (Figure 26.6). We do not need to explicitly program reading and writing class methods.

Listing 26.6: Export of the database to disk.

```

bool_t model_export(Model *model, const char_t *pathname, ferror_t *err)
{
  Stream *stm = stm_to_file(pathname, err);
  if (stm != NULL)
  {
    dbind_write(stm, model->products, ArrPt(Product));
    stm_close(&stm);
    return TRUE;
  }

  return FALSE;
}
  
```

Listing 26.7: Importing the database from disk.

```

bool_t model_import(Model *model, const char_t *pathname, ferror_t *err)
{
  Stream *stm = stm_from_file(pathname, err);
  if (stm != NULL)
  {
    ArrPt(Product) *products = dbind_read(stm, ArrPt(Product));
    stm_close(&stm);

    if (products != NULL)
    {
      dbind_destroy(&model->products, ArrPt(Product));
      model->products = products;
    }
  }
}
  
```



```

        return TRUE;
    }
}

return FALSE;
}

```

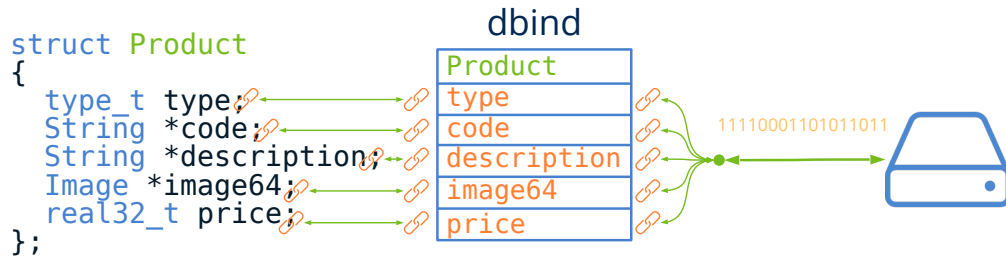

Figure 26.6: (De)serialization of binary objects by dbind.

26.4.3. Add/Delete records

And finally we will see how to add or delete records to the database using the constructors and destructors provided `dbind` by default. In (Listing 26.8) we create a new article and in (Listing 26.9) we destroy another existing one from its index.

Listing 26.8: Default constructor.

```

void model_add(Model *model)
{
    Product *product = dbind_create(Product);
    arrpt_append(model->products, product, Product);
}

```

Listing 26.9: Destructor.

```

static void i_destroy(Product **product)
{
    dbind_destroy(product, Product);
}

void model_delete(Model *model, const uint32_t index)
{
    arrpt_delete(model->products, index, i_destroy, Product);
}

```

26.5. View

We have fragmented the design of the main window into several blocks, each one implemented in its own *sublayout*. In “*Use of sublayouts*” (page 424) and “*Sub-layouts*” (page 354) you have examples about it. We start with a layout of a column and two rows (Listing 26.10) (Figure 26.7). In the upper cell we will place a sublayout with two other cells horizontally: one for the form and one for the login panel. The lower cell will be used for the *status bar*.

Listing 26.10: Composition of the main layout.

```
static Layout *i_layout(Ctrl *ctrl)
{
    Layout *layout = layout_create(1, 2);
    Layout *layout0 = layout_create(2, 1);
    Layout *layout1 = i_form(ctrl);
    Layout *layout2 = i_status_bar(ctrl);
    Panel *panell1 = i_login_panel(ctrl);
    layout_layout(layout0, layout1, 0, 0);
    layout_panel(layout0, panell1, 1, 0);
    layout_layout(layout, layout0, 0, 0);
    layout_layout(layout, layout2, 0, 1);
    return layout;
}
```

In turn, the layout that integrates the form, implemented in `i_form()`, is composed of three cells in vertical (Figure 26.8): One for the toolbar `i_toolbar()`, another for the selection slider and another for the article data `i_product()`. This last cell is a sublayout of two columns and three rows. In the central row we locate the labels `Type` and `Price` and, in the other two, four sublayout created by the functions `i_code_desc()`, `i_n_img()`, `i_type()` and `i_price()`.

If we look at the code of `i_product()`, reproduced partially in (Listing 26.11), we have made a “*Layout format*” (page 29), assigning a minimum width and height for the upper cells. We also indicate that the vertical expansion is performed on row 0, avoiding the expansion of rows 1 and 2, corresponding to the *label*, the *radiobutton* and the price.

Listing 26.11: Format of layout `i_product()`.

```
static Layout *i_product()
{
    Layout *layout = layout_create(2, 3);
    ...
    layout_hsize(layout, 0, 200.f);
    layout_hsize(layout, 1, 200.f);
    layout_vsize(layout, 0, 200.f);
    layout_vexpand(layout, 0);
    ...
}
```

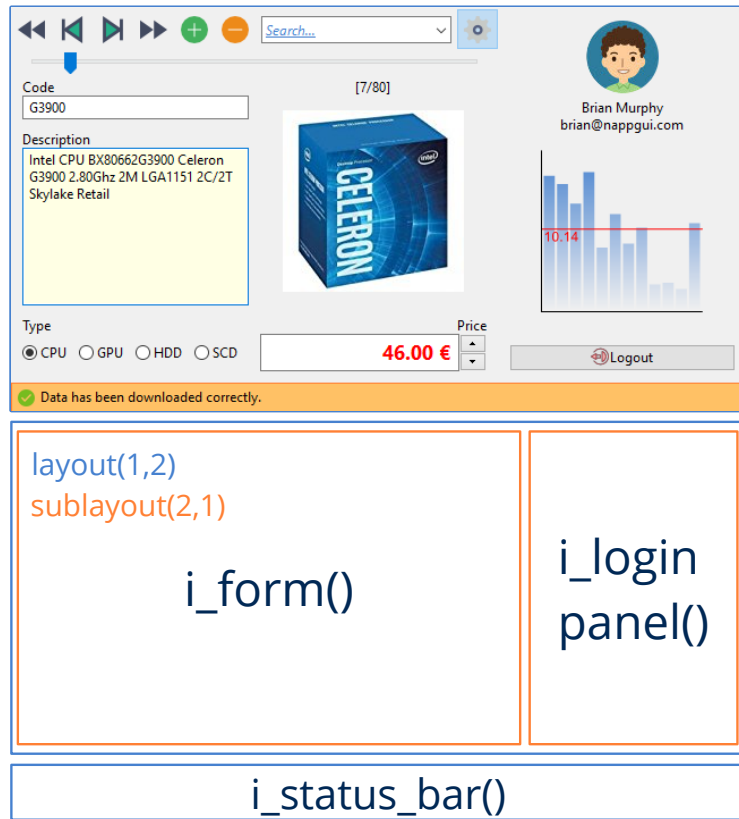

Figure 26.7: Main window layout.

26.5.1. Multi-layout panel

For user *login* we have used a panel with two different layouts: One for registration and another to show user data once registered (Listing 26.12) (Figure 26.9). This way, the controller can easily switch between them by calling `panel_visible_layout`. This function will be responsible for displaying/hiding controls and recalculating the size of the window, since it may have suffered variations due to the change in layout.

Listing 26.12: Creation of a multi-layout panel.

```
static Panel *i_login_panel(Ctrl *ctrl)
{
    Panel *panel = panel_create();
    Layout *layout0 = i_login(ctrl);
    Layout *layout1 = i_logout(ctrl);
    panel_layout(panel, layout0);
    panel_layout(panel, layout1);
    return panel;
}
```

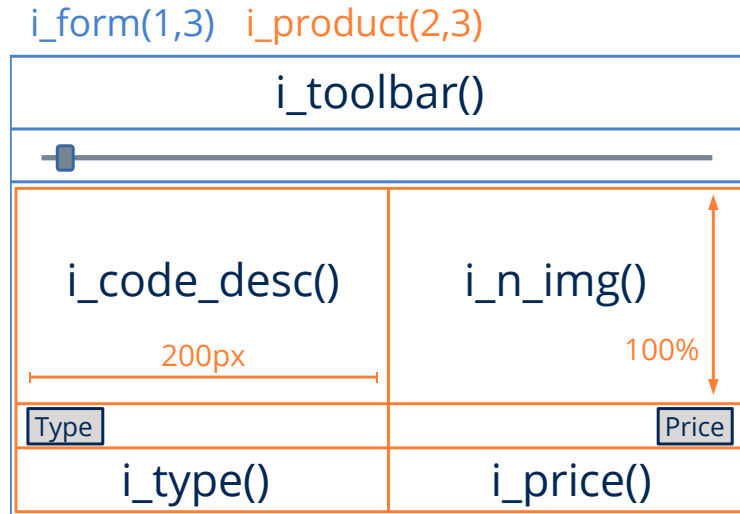

Figure 26.8: Layout que implementa el formulario.

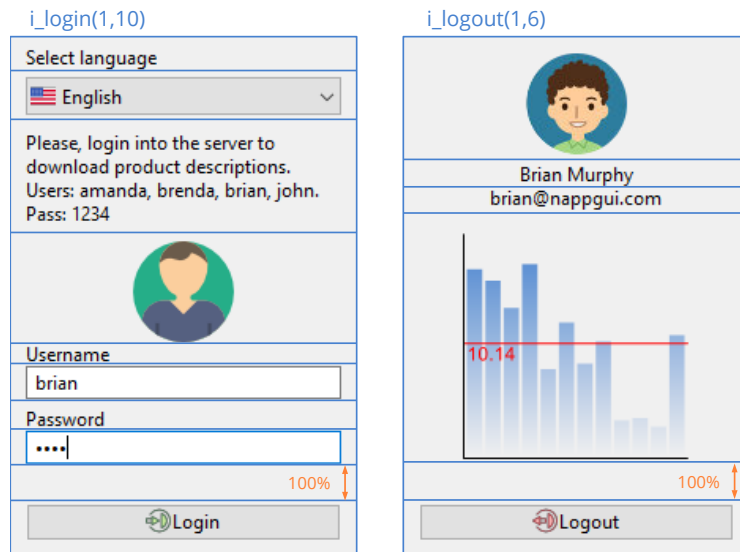

Figure 26.9: Login panel with two layouts.

26.5.2. Hide columns

It is also possible to hide the login panel through the menu or the corresponding button (Figure 26.10). This is simple to do inside the controller, acting on the column that contains said panel.

```
layout_show_col(ctrl->layout, 1, state == ekGUI_ON ? TRUE : FALSE);
```

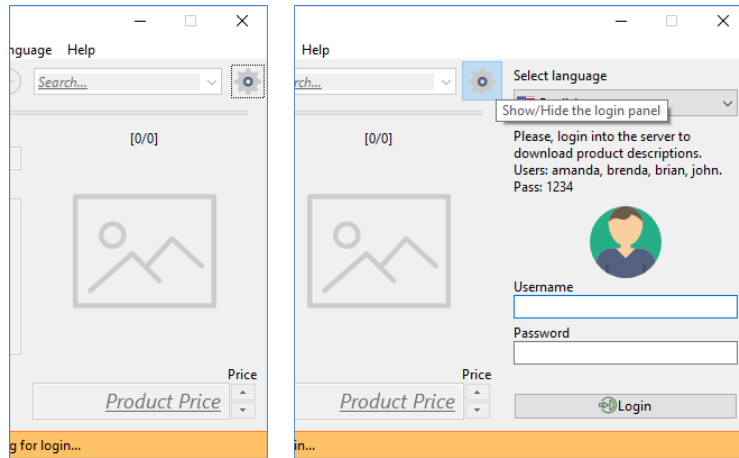

Figure 26.10: Show/Hide the login panel.

26.5.3. Bar graphs

One of the requirements is that the interface includes a small bar chart that shows the sales statistics of each product (Figure 26.11). The code generated by this graphic is in (Listing 26.13). In “*Use of Custom Views*” (page 426), “*Parametric drawing*” (page 427) and “*2D Contexts*” (page 265) you have more information about interactive graphics.

Listing 26.13: Parametric drawing of a bar graph.

```
static void i_OnStats(Ctrl *ctrl, Event *e)
{
    const EvDraw *params = event_params(e, EvDraw);
    uint32_t i, n = sizeof(ctrl->stats) / sizeof(real32_t);
    real32_t p = 10.f, x = p, y0 = params->height - p;
    real32_t w = (params->width - p * 2) / n;
    real32_t h = params->height - p * 2;
    real32_t avg = 0, pavg;
    char_t tavg[16];
    color_t c[2];
    real32_t stop[2] = {0, 1};
    c[0] = kHOLDER;
    c[1] = kCOLOR_VIEW;
    draw_fill_linear(params->ctx, c, stop, 2, 0, p, 0, params->height - p + 1);

    for (i = 0; i < n; ++i)
    {
        real32_t hr = h * (ctrl->stats[i] / i_MAX_STATS);
        real32_t y = p + h - hr;
        draw_rect(params->ctx, ekFILL, x, y, w - 2, hr);
        avg += ctrl->stats[i];
        x += w;
    }
}
```

```

avg /= n;
pavg = h * (avg / i_MAX_STATS);
pavg = p + h - pavg;
bstd_sprintf(tavg, sizeof(tavg), "%.2f", avg);
draw_fill_color(params->ctx, kTXTRED);
draw_line_color(params->ctx, kTXTRED);
draw_line(params->ctx, p - 2, pavg, params->width - p, pavg);
draw_line_color(params->ctx, kCOLOR_LABEL);
draw_line(params->ctx, p - 2, y0 + 2, params->width - p, y0 + 2);
draw_line(params->ctx, p - 2, y0 + 2, p - 2, p);
draw_text(params->ctx, ekFILL, tavg, p, pavg);
}

```

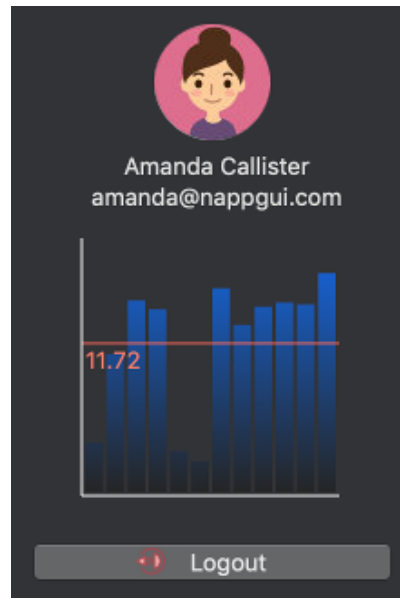

Figure 26.11: Dynamic graphs in the login panel.

26.5.4. Translations

The interface has been translated into seven languages, with English as default (Figure 26.12). To change the language, we call to `gui_language` within the `PopUp` event handler (Listing 26.14). In “*Resources*” (page 99) you have a step-by-step guide to locating and translating applications.

Listing 26.14: Code that changes the language of the program.

```

static void i_OnLang(Ctrl *ctrl, Event *e)
{
    const EvButton *params = event_params(e, EvButton);
    static const char_t *LANGS[] = { "en_US", "es_ES", "pt_PT", "it_IT", "vi_VN",
    ↵  ", "ru_RU", "ja_JP" };
}

```

```
gui_language(LANGS[params->index]);
}
```

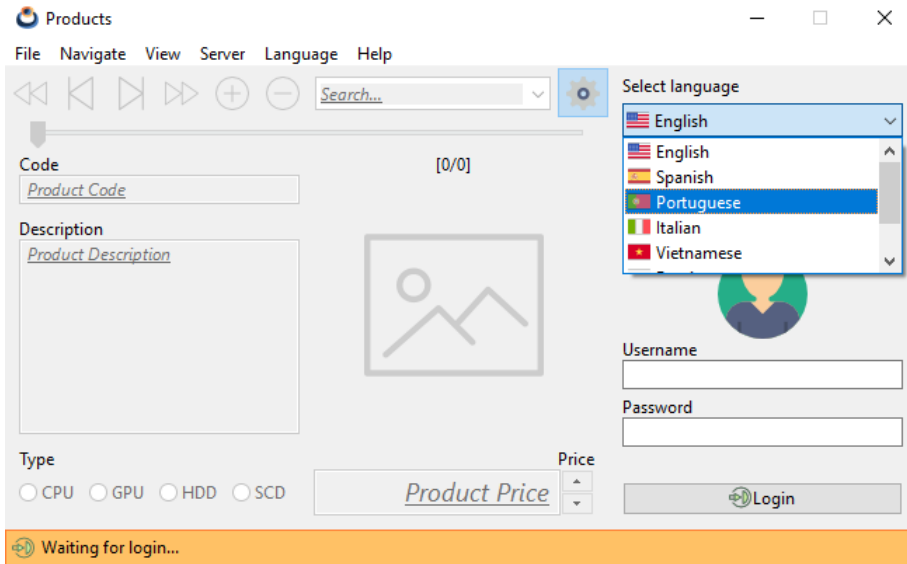

Figure 26.12: Automatic translations.

26.5.5. Dark Mode themes

NAppGUI uses native interface controls, which causes windows to integrate seamlessly with the active desktop theme on each machine. However, if we use custom icons or colors, these may not always be consistent when porting to other systems.

- In “Gui” (page 305) a series of “system” colors are defined, for example `gui_label_color`, whose RGB value will be resolved at runtime depending on the target platform. Using these functions, we will be certain that our applications will always look good and present a consistent color scheme. In “Color table” (page 769) you have a demo that shows these colors.
- Use `gui_alt_color` to define colors with two versions: One for light themes and one for dark ones. NAppGUI will be responsible for resolving the RGB whenever necessary (Listing 26.15).

Listing 26.15: Custom colors used in Products.

```
kHOLDER = gui_alt_color(color_bgr(0x4681Cf), color_bgr(0x1569E6));
kEDITBG = gui_alt_color(color_bgr(0xFFFFE4), color_bgr(0x101010));
kSTATBG = gui_alt_color(color_bgr(0xFFC165), color_bgr(0x523d1d));
kSTATSK = gui_alt_color(color_bgr(0xFF8034), color_bgr(0xFF8034));
kTXTRED = gui_alt_color(color_bgr(0xFF0000), color_bgr(0xEB665A));
```

- For the images, we must include two versions in the program resources and select one or the other depending on the `gui_dark_mode` value (Listing 26.16).

Listing 26.16: Icon selection for *Light* or *Dark Themes*.

```
void ctrl_theme_images(Ctrl *ctrl)
{
    bool_t dark = color_dark_mode();
    button_image(cell_button(ctrl->first_cell), dark ? FIRSTD_PNG :
        ↪ FIRST_PNG);
    button_image(cell_button(ctrl->back_cell), dark ? BACKD_PNG : BACK_PNG
        ↪ );
    button_image(cell_button(ctrl->next_cell), dark ? NEXTD_PNG : NEXT_PNG
        ↪ );
    button_image(cell_button(ctrl->last_cell), dark ? LASTD_PNG : LAST_PNG
        ↪ );
    button_image(cell_button(ctrl->add_cell), ADD_PNG);
    button_image(cell_button(ctrl->minus_cell), MINUS_PNG);
    button_image(cell_button(ctrl->setting_cell), SETTINGS_PNG);
    button_image(cell_button(ctrl->login_cell), LOGIN16_PNG);
    button_image(cell_button(ctrl->logout_cell), dark ? LOGOUT16D_PNG :
        ↪ LOGOUT16_PNG);
    menuitem_image(ctrl->import_item, OPEN_PNG);
    menuitem_image(ctrl->export_item, dark ? SAVED_PNG : SAVE_PNG);
    menuitem_image(ctrl->first_item, dark ? FIRST16D_PNG : FIRST16_PNG);
    menuitem_image(ctrl->back_item, dark ? BACK16D_PNG : BACK16_PNG);
    menuitem_image(ctrl->next_item, dark ? NEXT16D_PNG : NEXT16_PNG);
    menuitem_image(ctrl->last_item, dark ? LAST16D_PNG : LAST16_PNG);
    menuitem_image(ctrl->login_item, LOGIN16_PNG);
    menuitem_image(ctrl->logout_item, dark ? LOGOUT16D_PNG : LOGOUT16_PNG)
        ↪ ;
}

```

- Use `gui_OnThemeChanged` to update custom icons at runtime (Listing 26.17) (Figure 26.13).

Listing 26.17: Runtime icon update.

```
static void i_OnThemeChanged(App *app, Event *e)
{
    ctrl_theme_images(app->ctrl);
    unref(e);
}

gui_OnThemeChanged(listener(app, i_OnThemeChanged, App));

```

26.6. Controller

The controller is responsible for maintaining consistency between the Model and the View, as well as for implementing the **business logic**. Specifically, this program does

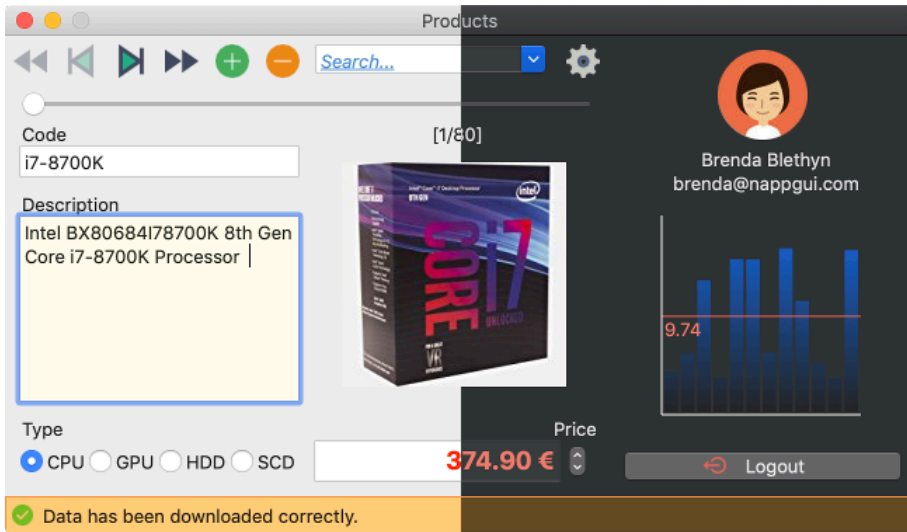

Figure 26.13: Desktop theme change.

virtually nothing with the data, regardless of downloading and displaying, which presents a good opportunity to practice.

26.6.1. Multi-threaded login

When the user presses the button [Login] the program calls two Web services. One to register the user and another to download the data. This process lasts about a second, which is an eternity from the point of view of a process. During this time you will come to appreciate that the program remains “frozen” waiting for the calls to the server to be resolved. This occurs because a “slow” task is running on the same thread that manages the program message loop (Figure 26.14)(a).

To avoid this unpleasant effect, which can be aggravated if the request lasts longer, we will use “*Multi-threaded tasks*” (page 398) by `osapp_task` (Listing 26.18) (Figure 26.14)(b). This creates a new execution thread that begins in `i_login_begin`. At the time the data has been downloaded, the NAppGUI task manager will call `i_login_end` (already in the main thread) and the program will continue with its (mono-thread) execution.

Listing 26.18: Multi-thread login process.

```
static void i_OnLogin(Ctrl *ctrl, Event *e)
{
    ctrl->status = ekIN_LOGIN;
    i_status(ctrl);
    osapp_task(ctrl, 0., i_login_begin, NULL, i_login_end, Ctrl);
    unref(e);
}
```

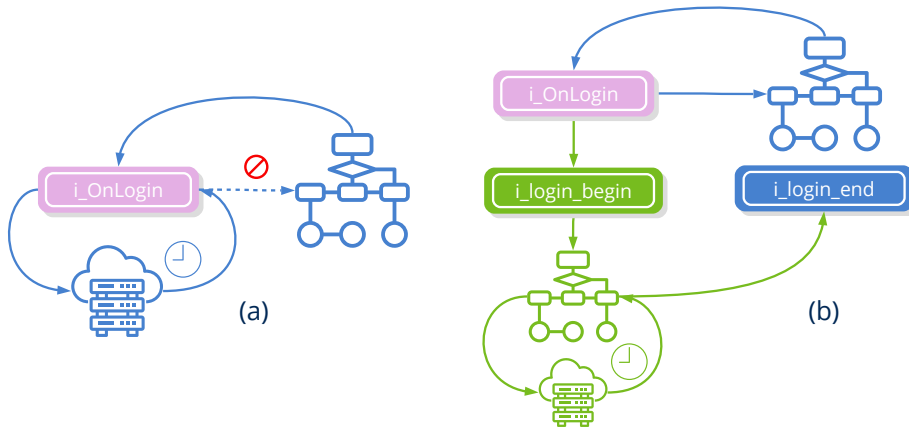

Figure 26.14: Execution of a “slow” task. Single-thread (a), Multi-thread (b). With a single thread the interface will be “frozen”.

26.6.2. Synchronize Model and View

Keeping the Data Model and the View synchronized is also the controller’s task. As the user interacts with the interface, it must capture the events, filter data and update the model objects. Similarly, every time the model changes it has to refresh the interface. This bidirectional synchronization can be done using **dbind**, saving a lot of extra programming code (Figure 26.15).

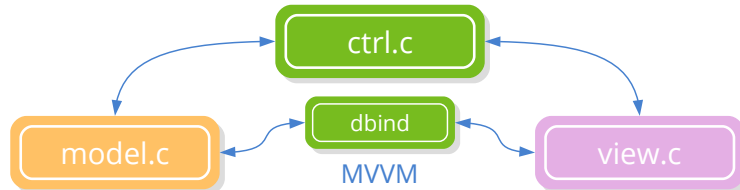

Figure 26.15: DBind helps the controller in the recurring task of synchronizing objects with the interface.

The implementation of this **MVVM** pattern *Model-View-ViewModel* is quite simple and we have it summarized in (Listing 26.19) (Figure 26.16).

- Use `cell_dbind` to link a layout cell with a model field.
- Use `layout_dbind` to link the layout containing the previous cells with the struct which contains the fields.
- Use `layout_dbind_obj` to assign an object to the layout. From here the Model-View updates will be made automatically.

Listing 26.19: Binding struct with layout.

```

// In View
Cell *cell10 = layout_cell(layout, 0, 1);
...
cell_dbind(cell10, Product, String*, code);
cell_dbind(cell11, Product, String*, description);
cell_dbind(cell12, Product, type_t, type);
cell_dbind(cell13, Product, Image*, image64);
cell_dbind(cell14, Product, real32_t, price);
layout_dbind(layout, Product);

// In Controller
Product *product = model_product(model, index);
layout_dbind_obj(layout, product, Product);

```

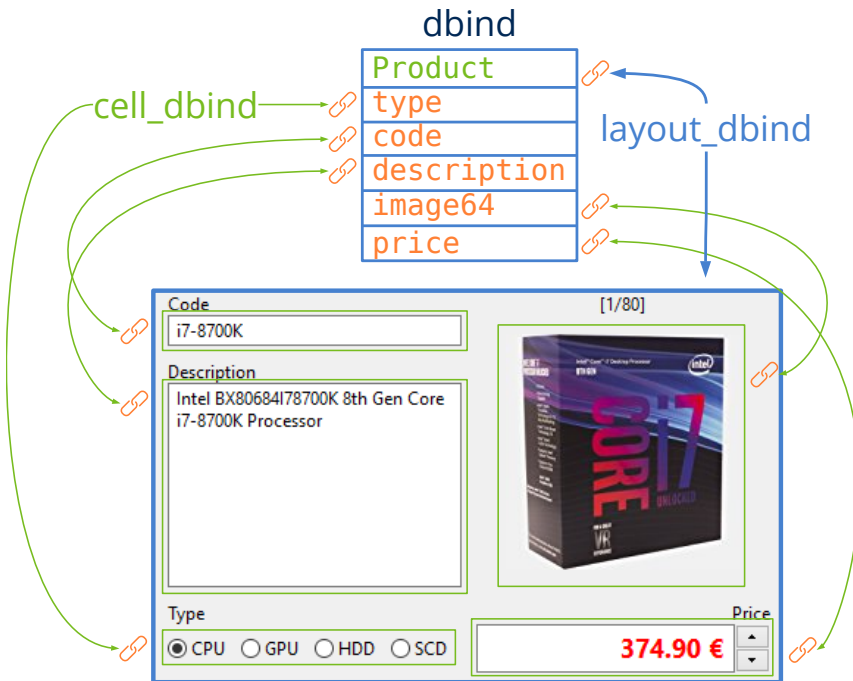

Figure 26.16: Data binding in GUI.

It is common for data to be reviewed (filtered) after editing to verify that the values are consistent with the model. **dbind** supports different formats for registered fields. In (Listing 26.20) we have applied formatting to the field `price` from `Product`.

Listing 26.20: Field format price from `Product`.

```

dbind_default(Product, real32_t, price, 1);
dbind_range(Product, real32_t, price, .50f, 1e6f);
dbind_precision(Product, real32_t, price, .05f);
dbind_increment(Product, real32_t, price, 5.f);

```

```
dbind_suffix(Product, real32_t, price, "€");
```

26.6.3. Change the image

To change the image associated with the product, the controller has slightly modified the operation of the `ImageView`, which will show an edit icon each time the mouse is placed on top of the image (Listing 26.21), (Figure 26.17).

Listing 26.21: Drawing an *overlay* when the mouse is over the image.

```
static void i_OnImgDraw(Ctrl *ctrl, Event *e)
{
    const EvDraw *params = event_params(e, EvDraw);
    const Image *image = gui_repack_image(EDIT_PNG);
    uint32_t w, h;
    image_size(image, &w, &h);
    draw_image(params->context, image, params->width - w - 10, params->height -
        ↪ h - 10);
    unref(ctrl);
}
...
imageview_OnOverDraw(view, listener(ctrl, i_OnImgDraw, Ctrl));
```

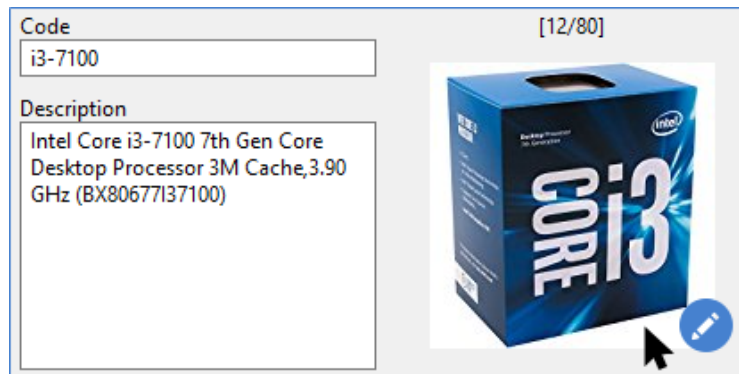

Figure 26.17: Superimposed icon on image control.

Clicking on the image will open the file opening dialog that will allow us to select a new one. If the dialog is accepted, the image will be loaded and assigned to control (Listing 26.22). The object will update automatically.

Listing 26.22: Drawing an *overlay* when the mouse is over the image.

```
static void i_OnImgClick(Ctrl *ctrl, Event *e)
{
    const char_t *type[] = { "png", "jpg" };
    const char_t *file = comwin_open_file(type, 2, NULL);
    if (file != NULL)
```

```

{
    Image *image = image_from_file(file, NULL);
    if (image != NULL)
    {
        View *view = cell_view(ctrl->image_cell);
        imageview_image(view, image);
        image_destroy(&image);
    }
}
unref(e);
}
...
imageview_OnClick(view, listener(ctrl, i_OnImgClick, Ctrl));

```

26.6.4. Memory management

After closing the program, a report will be printed with the use of memory, alerting us to possible *memory leaks* (Listing 26.23). It does not hurt to check it periodically in order to detect anomalies as soon as possible.

Listing 26.23: Memory usage statistics, generated at the close of any NAppGUI application.

```

[22:17:21] [OK] Heap Memory Statistics
[22:17:21] =====
[22:17:21] Total a/dellocations: 2065, 2065
[22:17:21] Total bytes a/dellocated: 2831766, 2831766
[22:17:21] Max bytes allocated: 1642879
[22:17:21] Effective reallocations: (0/55)
[22:17:21] Real allocations: 13 pages of 65536 bytes
[22:17:21]                    5 pages greater than 65536 bytes
[22:17:21] =====

```

If we want more detailed information about the use of memory, we can pass the parameter `"-hv"` in the options field of `osmain` (Listing 26.24).

```
osmain(i_create, i_destroy, "-hv", App)
```

Listing 26.24: Detailed output of memory usage.

```

[12:01:41] 'App' a/deallocations: 1, 1 (32) bytes
[12:01:41] 'ArrPt::Cell' a/deallocations: 24, 24 (576) bytes
[12:01:41] 'ArrPt::GuiComponent' a/deallocations: 8, 8 (192) bytes
...
[12:01:41] 'Button' a/deallocations: 13, 13 (1664) bytes
[12:01:41] 'View' a/deallocations: 5, 5 (840) bytes
[12:01:41] 'Clock' a/deallocations: 1, 1 (48) bytes
[12:01:41] 'Combo' a/deallocations: 1, 1 (176) bytes
...
[12:01:41] 'UpDown' a/deallocations: 1, 1 (64) bytes
[12:01:41] 'VImgData' a/deallocations: 4, 4 (160) bytes

```

```
[12:01:41] 'Window' a/deallocations: 1, 1 (80) bytes
[12:01:41] 'bool_t::arr' a/deallocations: 6, 6 (27) bytes
[12:01:41] 'i_App' a/deallocations: 1, 1 (184) bytes
[12:01:41] 'i_Task' a/deallocations: 1, 1 (64) bytes
```

26.7. The complete program

Listing 26.25: demo/products/products.hxx

```
/* Products Types */

#ifdef __TYPES_HXX__
#define __TYPES_HXX__

#include <gui/gui.hxx>

typedef enum _wserv_t
{
    ekWS_CONNECT = 1,
    ekWS_JSON,
    ekWS_ACCESS,
    ekWS_OK
} wserv_t;

typedef struct _model_t Model;
typedef struct _product_t Product;
typedef struct _ctrl_t Ctrl;

__EXTERN_C

extern color_t kHOLDER;
extern color_t kEDITBG;
extern color_t kSTATBG;
extern color_t kSTATSK;
extern color_t kTXTRED;

__END_C

#endif
```

Listing 26.26: demo/products/products.c

```
/* NAppGUI Products Demo */

#include "nappgui.h"
#include "prmodel.h"
#include "prmenu.h"
#include "prctrl.h"
#include "prview.h"
#include "res_products.h"
```

```

#include <inet/inet.h>

typedef struct _app_t App;
struct _app_t
{
    Model *model;
    Ctrl *ctrl;
    Window *window;
    Menu *menu;
};

color_t kHOLDER;
color_t kEDITBG;
color_t kSTATBG;
color_t kSTATSK;
color_t kTXTRED;

/*-----*/

static void i_OnThemeChanged(App *app, Event *e)
{
    ctrl_theme_images(app->ctrl);
    unref(e);
}

/*-----*/

static App *i_create(void)
{
    App *app = heap_new(App);
    kHOLDER = gui_alt_color(color_bgr(0x4681Cf), color_bgr(0x1569E6));
    kEDITBG = gui_alt_color(color_bgr(0xFFFFe4), color_bgr(0x101010));
    kSTATBG = gui_alt_color(color_bgr(0xFFC165), color_bgr(0x523d1d));
    kSTATSK = gui_alt_color(color_bgr(0xFF8034), color_bgr(0xFF8034));
    kTXTRED = gui_alt_color(color_bgr(0xFF0000), color_bgr(0xEB665A));
    inet_start();
    gui_respack(res_products_respack);
    gui_language("");
    gui_OnThemeChanged(listener(app, i_OnThemeChanged, App));
    model_bind();
    app->model = model_create();
    app->ctrl = ctrl_create(app->model);
    app->menu = prmenu_create(app->ctrl);
    app->window = prview_create(app->ctrl);
    osapp_menubar(app->menu, app->window);
    window_origin(app->window, v2df(100.f, 100.f));
    window_show(app->window);
    ctrl_run(app->ctrl);
    return app;
}

```

```

/*-----*/

static void i_destroy(App **app)
{
    cassert_no_null(app);
    cassert_no_null(*app);
    ctrl_destroy(&(*app)->ctrl);
    window_destroy(&(*app)->window);
    menu_destroy(&(*app)->menu);
    model_destroy(&(*app)->model);
    inet_finish();
    heap_delete(app, App);
}

/*-----*/

#include "osmain.h"
osmain(i_create, i_destroy, "", App)

```

Listing 26.27: demo/products/prmodel.c

```

/* Products Model */

#include "prmodel.h"
#include "res_products.h"
#include <gui/guiall.h>
#include <inet/httpreq.h>
#include <inet/json.h>

typedef struct _pjson_t PJson;

typedef enum _type_t
{
    ekCPU,
    ekGPU,
    ekHDD,
    ekSCD
} type_t;

struct _product_t
{
    type_t type;
    String *code;
    String *description;
    Image *image64;
    real32_t price;
};

struct _pjson_t
{
    int32_t code;

```



```

    uint32_t size;
    ArrPt(Product) *data;
};

struct _model_t
{
    ArrSt(uint32_t) *filter;
    ArrPt(Product) *products;
};

DeclPt(Product);

/*-----*/

Model *model_create(void)
{
    Model *model = heap_new(Model);
    model->filter = arrst_create(uint32_t);
    model->products = arrpt_create(Product);
    return model;
}

/*-----*/

void model_destroy(Model **model)
{
    arrst_destroy(&(*model)->filter, NULL, uint32_t);
    dbind_destroy(&(*model)->products, ArrPt(Product));
    heap_delete(model, Model);
}

/*-----*/

static Stream *i_http_get(void)
{
    Http *http = http_create("serv.nappgui.com", 80);
    Stream *stm = NULL;

    if (http_get(http, "/dproducts.php", NULL, 0, NULL) == TRUE)
    {
        uint32_t status = http_response_status(http);
        if (status >= 200 && status <= 299)
        {
            stm = stm_memory(4096);
            if (http_response_body(http, stm, NULL) == FALSE)
                stm_close(&stm);
        }
    }

    http_destroy(&http);
    return stm;
}

```

```

}

/*-----*/

wserv_t model_webserv(Model *model)
{
    Stream *stm = i_http_get();
    if (stm != NULL)
    {
        PJson *json = json_read(stm, NULL, PJson);
        stm_close(&stm);

        if (json != NULL)
        {
            cassert(json->size == arrpt_size(json->data, Product));
            dbind_destroy(&model->products, ArrPt(Product));
            model->products = json->data;
            json->data = NULL;
            json_destroy(&json, PJson);
            return ekWS_OK;
        }

        return ekWS_JSON;
    }

    return ekWS_CONNECT;
}

/*-----*/

bool_t model_import(Model *model, const char_t *pathname, ferror_t *err)
{
    Stream *stm = stm_from_file(pathname, err);
    if (stm != NULL)
    {
        ArrPt(Product) *products = dbind_read(stm, ArrPt(Product));
        stm_close(&stm);

        if (products != NULL)
        {
            dbind_destroy(&model->products, ArrPt(Product));
            model->products = products;
            return TRUE;
        }

        return FALSE;
    }
}

/*-----*/

```

```

bool_t model_export(Model *model, const char_t *pathname, ferror_t *err)
{
    Stream *stm = stm_to_file(pathname, err);
    if (stm != NULL)
    {
        dbind_write(stm, model->products, ArrPt(Product));
        stm_close(&stm);
        return TRUE;
    }

    return FALSE;
}

/*-----*/

uint32_t model_count(const Model *model)
{
    uint32_t total = arrst_size(model->filter, uint32_t);
    if (total == 0)
        total = arrpt_size(model->products, Product);
    return total;
}

/*-----*/

void model_clear(Model *model)
{
    dbind_destroy(&model->products, ArrPt(Product));
    arrst_clear(model->filter, NULL, uint32_t);
    model->products = dbind_create(ArrPt(Product));
}

/*-----*/

void model_add(Model *model)
{
    Product *product = dbind_create(Product);
    arrpt_append(model->products, product, Product);
    arrst_clear(model->filter, NULL, uint32_t);
}

/*-----*/

static uint32_t i_index(ArrSt(uint32_t) *filter, const uint32_t index)
{
    if (arrst_size(filter, uint32_t) > 0)
        return *arrst_get(filter, index, uint32_t);
    else
        return index;
}

```

```

/*-----*/
static __INLINE void i_destroy(Product **product)
{
    dbind_destroy(product, Product);
}
/*-----*/

void model_delete(Model *model, const uint32_t index)
{
    uint32_t lindex = i_index(model->filter, index);
    arrpt_delete(model->products, lindex, i_destroy, Product);
    arrst_clear(model->filter, NULL, uint32_t);
}
/*-----*/

bool_t model_filter(Model *model, const char_t *filter)
{
    ArrSt(uint32_t) *new_filter = arrst_create(uint32_t);

    arrpt_foreach(product, model->products, Product)
        if (str_str(tc(product->description), filter) != NULL)
            arrst_append(new_filter, product_i, uint32_t);
    arrpt_end()

    arrst_destroy(&model->filter, NULL, uint32_t);
    model->filter = new_filter;

    return (bool_t)(arrst_size(new_filter, uint32_t) > 0);
}
/*-----*/

Product *model_product(Model *model, const uint32_t product_id)
{
    uint32_t lindex = i_index(model->filter, product_id);
    return arrpt_get(model->products, lindex, Product);
}
/*-----*/

void model_bind(void)
{
    dbind_enum(type_t, ekCPU, "");
    dbind_enum(type_t, ekGPU, "");
    dbind_enum(type_t, ekHDD, "");
    dbind_enum(type_t, ekSCD, "");
    dbind(Product, type_t, type);
    dbind(Product, String *, code);
}

```

```

dbind(Product, String *, description);
dbind(Product, Image *, image64);
dbind(Product, real32_t, price);
dbind(PJson, int32_t, code);
dbind(PJson, uint32_t, size);
dbind(PJson, ArrPt(Product) *, data);
dbind_default(Product, real32_t, price, 1);
dbind_range(Product, real32_t, price, .50f, 1e6f);
dbind_precision(Product, real32_t, price, .05f);
dbind_increment(Product, real32_t, price, 5.f);
dbind_suffix(Product, real32_t, price, "€");
dbind_default(Product, Image *, image64, gui_image(NOIMAGE_PNG));
}

/*-----*/

void model_layout(Layout *layout)
{
    layout_dbind(layout, NULL, Product);
}

/*-----*/

void model_type(Cell *cell)
{
    cell_dbind(cell, Product, type_t, type);
}

/*-----*/

void model_code(Cell *cell)
{
    cell_dbind(cell, Product, String *, code);
}

/*-----*/

void model_desc(Cell *cell)
{
    cell_dbind(cell, Product, String *, description);
}

/*-----*/

void model_image(Cell *cell)
{
    cell_dbind(cell, Product, Image *, image64);
}

/*-----*/

```

```

void model_price(Cell *cell)
{
    cell_dbind(cell, Product, real32_t, price);
}

```

Listing 26.28: demo/products/prview.c

```

/* Products View */

#include "prview.h"
#include "prctrl.h"
#include "res_products.h"
#include <gui/guiall.h>

/*-----*/

static Layout *i_toolbar(Ctrl *ctrl)
{
    Layout *layout = layout_create(8, 1);
    Button *button0 = button_flat();
    Button *button1 = button_flat();
    Button *button2 = button_flat();
    Button *button3 = button_flat();
    Button *button4 = button_flat();
    Button *button5 = button_flat();
    Button *button6 = button_flatgle();
    Combo *combo = combo_create();
    button_text(button0, TWIN_FIRST);
    button_text(button1, TWIN_BACK);
    button_text(button2, TWIN_NEXT);
    button_text(button3, TWIN_LAST);
    button_text(button4, TWIN_ADD);
    button_text(button5, TWIN_DEL);
    button_text(button6, TWIN_SETTINGS_PANEL);
    combo_tooltip(combo, TWIN_FILTER_DESC);
    combo_bgcolor_focus(combo, kEDITBG);
    combo_phtext(combo, TWIN_FILTER);
    combo_phcolor(combo, kHOLDER);
    combo_phstyle(combo, ekFITALIC | ekFUNDERLINE);
    layout_button(layout, button0, 0, 0);
    layout_button(layout, button1, 1, 0);
    layout_button(layout, button2, 2, 0);
    layout_button(layout, button3, 3, 0);
    layout_button(layout, button4, 4, 0);
    layout_button(layout, button5, 5, 0);
    layout_combo(layout, combo, 6, 0);
    layout_button(layout, button6, 7, 0);
    layout_hmargin(layout, 5, 5);
    layout_hmargin(layout, 6, 5);
    layout_hexpand(layout, 6);
    ctrl_first_cell(ctrl, layout_cell(layout, 0, 0));
}

```

```

ctrl_back_cell(ctrl, layout_cell(layout, 1, 0));
ctrl_next_cell(ctrl, layout_cell(layout, 2, 0));
ctrl_last_cell(ctrl, layout_cell(layout, 3, 0));
ctrl_add_cell(ctrl, layout_cell(layout, 4, 0));
ctrl_minus_cell(ctrl, layout_cell(layout, 5, 0));
ctrl_filter_cell(ctrl, layout_cell(layout, 6, 0));
ctrl_setting_cell(ctrl, layout_cell(layout, 7, 0));
return layout;
}

/*-----*/

static Layout *i_code_desc(Ctrl *ctrl)
{
    Layout *layout = layout_create(1, 4);
    Label *label0 = label_create();
    Label *label1 = label_create();
    Edit *edit0 = edit_create();
    Edit *edit1 = edit_multiline();
    label_text(label0, TWIN_CODE);
    label_text(label1, TWIN_DESC);
    edit_phtext(edit0, TWIN_TYPE_CODE);
    edit_phtext(edit1, TWIN_TYPE_DESC);
    edit_bgcolor_focus(edit0, kEDITBG);
    edit_bgcolor_focus(edit1, kEDITBG);
    edit_phcolor(edit0, kHOLDER);
    edit_phcolor(edit1, kHOLDER);
    edit_phstyle(edit0, ekFITALIC | ekFUNDERLINE);
    edit_phstyle(edit1, ekFITALIC | ekFUNDERLINE);
    layout_label(layout, label0, 0, 0);
    layout_edit(layout, edit0, 0, 1);
    layout_label(layout, label1, 0, 2);
    layout_edit(layout, edit1, 0, 3);
    layout_vmargn(layout, 1, 10);
    layout_vexpand(layout, 3);
    ctrl_code_cell(ctrl, layout_cell(layout, 0, 1));
    ctrl_desc_cell(ctrl, layout_cell(layout, 0, 3));
    return layout;
}

/*-----*/

static Layout *i_type(void)
{
    Layout *layout = layout_create(4, 1);
    Button *button0 = button_radio();
    Button *button1 = button_radio();
    Button *button2 = button_radio();
    Button *button3 = button_radio();
    button_text(button0, TWIN_CPU);
    button_text(button1, TWIN_GPU);

```

```

    button_text(button2, TWIN_HDD);
    button_text(button3, TWIN_SCD);
    layout_button(layout, button0, 0, 0);
    layout_button(layout, button1, 1, 0);
    layout_button(layout, button2, 2, 0);
    layout_button(layout, button3, 3, 0);
    return layout;
}

/*-----*/

static Layout *i_n_img(Ctrl *ctrl)
{
    Layout *layout = layout_create(1, 2);
    Label *label = label_create();
    ImageView *view = imageview_create();
    label_align(label, ekCENTER);
    layout_halign(layout, 0, 0, ekJUSTIFY);
    layout_label(layout, label, 0, 0);
    layout_imageview(layout, view, 0, 1);
    layout_vexpand(layout, 1);
    ctrl_counter_cell(ctrl, layout_cell(layout, 0, 0));
    ctrl_image_cell(ctrl, layout_cell(layout, 0, 1));
    return layout;
}

/*-----*/

static Layout *i_price(void)
{
    Layout *layout = layout_create(2, 1);
    Edit *edit = edit_create();
    Font *font = font_system(18, ekFBOLD);
    UpDown *updown = updown_create();
    edit_phtext(edit, TWIN_TYPE_PRICE);
    edit_font(edit, font);
    edit_align(edit, ekRIGHT);
    edit_color(edit, kTXTRED);
    edit_bgcolor_focus(edit, kEDITBG);
    edit_phcolor(edit, kHOLDER);
    edit_phstyle(edit, ekFITALIC | ekFUNDERLINE);
    layout_edit(layout, edit, 0, 0);
    layout_updown(layout, updown, 1, 0);
    layout_hsize(layout, 1, 24);
    layout_hexpand(layout, 0);
    font_destroy(&font);
    return layout;
}

/*-----*/

```



```

static Layout *i_product(Ctrl *ctrl)
{
    Layout *layout = layout_create(2, 3);
    Layout *layout0 = i_code_desc(ctrl);
    Layout *layout1 = i_type();
    Layout *layout2 = i_n_img(ctrl);
    Layout *layout3 = i_price();
    Label *label0 = label_create();
    Label *label1 = label_create();
    label_text(label0, TWIN_TYPE);
    label_text(label1, TWIN_PRICE);
    layout_layout(layout, layout0, 0, 0);
    layout_label(layout, label0, 0, 1);
    layout_layout(layout, layout1, 0, 2);
    layout_layout(layout, layout2, 1, 0);
    layout_label(layout, label1, 1, 1);
    layout_layout(layout, layout3, 1, 2);
    layout_halign(layout, 1, 1, ekRIGHT);
    layout_hsize(layout, 1, 200);
    layout_vsize(layout, 0, 200);
    layout_hmargin(layout, 0, 10);
    layout_vmargin(layout, 0, 10);
    layout_margin4(layout, 0, 10, 10, 10);
    layout_vexpand(layout, 0);
    ctrl_type_cell(ctrl, layout_cell(layout, 0, 2));
    ctrl_price_cell(ctrl, layout_cell(layout, 1, 2));
    return layout;
}

/*-----*/

static Layout *i_form(Ctrl *ctrl)
{
    Layout *layout = layout_create(1, 3);
    Layout *layout0 = i_toolbar(ctrl);
    Layout *layout1 = i_product(ctrl);
    Slider *slider = slider_create();
    Cell *cell = NULL;
    layout_layout(layout, layout0, 0, 0);
    layout_slider(layout, slider, 0, 1);
    layout_layout(layout, layout1, 0, 2);
    layout_vexpand(layout, 2);
    cell = layout_cell(layout, 0, 1);
    cell_padding4(cell, 0, 10, 0, 10);
    ctrl_slider_cell(ctrl, cell);
    return layout;
}

/*-----*/

static Layout *i_login(Ctrl *ctrl)

```

```

{
    Layout *layout = layout_create(1, 10);
    Label *label0 = label_create();
    Label *label1 = label_multiline();
    Label *label2 = label_create();
    Label *label3 = label_create();
    PopUp *popup0 = popup_create();
    ImageView *view0 = imageview_create();
    Edit *edit0 = edit_create();
    Edit *edit1 = edit_create();
    Button *button = button_push();
    label_text(label0, TWIN_SETLANG);
    label_text(label1, TWIN_LOGIN_MSG);
    label_text(label2, TWIN_USER);
    label_text(label3, TWIN_PASS);
    popup_add_elem(popup0, ENGLISH, (const Image*)USA_PNG);
    popup_add_elem(popup0, SPANISH, (const Image*)SPAIN_PNG);
    popup_add_elem(popup0, PORTUGUESE, (const Image*)PORTUGAL_PNG);
    popup_add_elem(popup0, ITALIAN, (const Image*)ITALY_PNG);
    popup_add_elem(popup0, VIETNAMESE, (const Image*)VIETNAM_PNG);
    popup_add_elem(popup0, RUSSIAN, (const Image*)RUSSIA_PNG);
    popup_add_elem(popup0, JAPANESE, (const Image*)JAPAN_PNG);
    popup_tooltip(popup0, TWIN_SETLANG);
    imageview_image(view0, (const Image*)USER_PNG);
    edit_passmode(edit1, TRUE);
    button_text(button, TWIN_LOGIN);
    layout_label(layout, label0, 0, 0);
    layout_popup(layout, popup0, 0, 1);
    layout_label(layout, label1, 0, 2);
    layout_imageview(layout, view0, 0, 3);
    layout_label(layout, label2, 0, 4);
    layout_edit(layout, edit0, 0, 5);
    layout_label(layout, label3, 0, 6);
    layout_edit(layout, edit1, 0, 7);
    layout_button(layout, button, 0, 9);
    layout_vmargin(layout, 0, 5);
    layout_vmargin(layout, 1, 10);
    layout_vmargin(layout, 2, 10);
    layout_vmargin(layout, 5, 5);
    layout_vmargin(layout, 8, 5);
    layout_margin4(layout, 5, 10, 10, 10);
    layout_hsize(layout, 0, 200);
    layout_vexpand(layout, 8);
    ctrl_lang_cell(ctrl, layout_cell(layout, 0, 1));
    ctrl_user_cell(ctrl, layout_cell(layout, 0, 5));
    ctrl_pass_cell(ctrl, layout_cell(layout, 0, 7));
    ctrl_login_cell(ctrl, layout_cell(layout, 0, 9));
    return layout;
}

```

```
/*-----*/
```

```

static Layout *i_logout(Ctrl *ctrl)
{
    Layout *layout = layout_create(1, 6);
    ImageView *view = imageview_create();
    Label *label0 = label_create();
    Label *label1 = label_create();
    View *cview = view_create();
    Button *button = button_push();
    label_align(label0, ekCENTER);
    label_align(label1, ekCENTER);
    button_text(button, TWIN_LOGOUT);
    view_size(cview, s2df(160, 160));
    layout_imageview(layout, view, 0, 0);
    layout_label(layout, label0, 0, 1);
    layout_label(layout, label1, 0, 2);
    layout_view(layout, cview, 0, 3);
    layout_button(layout, button, 0, 5);
    layout_halign(layout, 0, 1, ekJUSTIFY);
    layout_halign(layout, 0, 2, ekJUSTIFY);
    layout_halign(layout, 0, 3, ekCENTER);
    layout_vmargin(layout, 0, 5);
    layout_vmargin(layout, 2, 5);
    layout_vexpand(layout, 4);
    layout_hsize(layout, 0, 200);
    layout_margin(layout, 10);
    ctrl_stats_cell(ctrl, layout_cell(layout, 0, 3));
    ctrl_logout_cell(ctrl, layout_cell(layout, 0, 5));
    return layout;
}

/*-----*/

static Panel *i_login_panel(Ctrl *ctrl)
{
    Panel *panel = panel_create();
    Layout *layout0 = i_login(ctrl);
    Layout *layout1 = i_logout(ctrl);
    panel_layout(panel, layout0);
    panel_layout(panel, layout1);
    ctrl_login_panel(ctrl, panel);
    return panel;
}

/*-----*/

static Layout *i_status_bar(Ctrl *ctrl)
{
    Layout *layout = layout_create(2, 1);
    ImageView *view = imageview_create();
    Label *label = label_create();

```

```

    imageview_size(view, s2df(16, 16));
    layout_imageview(layout, view, 0, 0);
    layout_label(layout, label, 1, 0);
    layout_halign(layout, 1, 0, ekJUSTIFY);
    layout_hexpand(layout, 1);
    layout_hmargin(layout, 0, 5);
    layout_margin(layout, 5);
    layout_bgcolor(layout, kSTATBG);
    layout_skcolor(layout, kSTATSK);
    ctrl_status_layout(ctrl, layout);
    return layout;
}

/*-----*/

static Layout *i_layout(Ctrl *ctrl)
{
    Layout *layout = layout_create(1, 2);
    Layout *layout0 = layout_create(2, 1);
    Layout *layout1 = i_form(ctrl);
    Layout *layout2 = i_status_bar(ctrl);
    Panel *panell1 = i_login_panel(ctrl);
    layout_layout(layout0, layout1, 0, 0);
    layout_panel(layout0, panell1, 1, 0);
    layout_layout(layout, layout0, 0, 0);
    layout_layout(layout, layout2, 0, 1);
    ctrl_main_layout(ctrl, layout0);
    return layout;
}

/*-----*/

Window *prview_create(Ctrl *ctrl)
{
    Panel *panel = panel_create();
    Layout *layout = i_layout(ctrl);
    Window *window = NULL;
    ctrl_theme_images(ctrl);
    panel_layout(panel, layout);
    window = window_create(ekWINDOW_STD);
    window_panel(window, panel);
    window_title(window, TWIN_TITLE);
    ctrl_window(ctrl, window);
    return window;
}

```

Listing 26.29: demo/products/prmenu.c

```
/* Products Menu */
```

```
#include "prmenu.h"
```

```

#include "prctrl.h"
#include "res_products.h"
#include <gui/guiall.h>

/*-----*/

#if defined (__APPLE__)
static Menu *i_app(Ctrl *ctrl)
{
    Menu *menu = menu_create();
    MenuItem *item0 = menuitem_create();
    MenuItem *item1 = menuitem_separator();
    MenuItem *item2 = menuitem_create();
    MenuItem *item3 = menuitem_separator();
    MenuItem *item4 = menuitem_create();
    menuitem_text(item0, TMEN_ABOUT);
    menuitem_text(item2, TMEN_PREFERS);
    menuitem_text(item4, TMEN_QUIT);
    menu_item(menu, item0);
    menu_item(menu, item1);
    menu_item(menu, item2);
    menu_item(menu, item3);
    menu_item(menu, item4);
    ctrl_about_item(ctrl, item0);
    ctrl_exit_item(ctrl, item4);
    return menu;
}
#endif

/*-----*/

static Menu *i_file(Ctrl *ctrl)
{
    Menu *menu = menu_create();
    MenuItem *item0 = menuitem_create();
    MenuItem *item1 = menuitem_create();
    menuitem_text(item0, TMEN_IMPORT);
    menuitem_text(item1, TMEN_EXPORT);
    menu_item(menu, item0);
    menu_item(menu, item1);

#if !defined (__APPLE__)
    {
        MenuItem *item2 = menuitem_separator();
        MenuItem *item3 = menuitem_create();
        menuitem_text(item3, TMEN_EXIT);
        menuitem_image(item3, (const Image*)EXIT_PNG);
        menu_item(menu, item2);
        menu_item(menu, item3);
        ctrl_exit_item(ctrl, item3);
    }
}

```

```

#endif

    ctrl_import_item(ctrl, item0);
    ctrl_export_item(ctrl, item1);
    return menu;
}

/*-----*/

static Menu *i_navigate(Ctrl *ctrl)
{
    Menu *menu = menu_create();
    MenuItem *item0 = menuitem_create();
    MenuItem *item1 = menuitem_create();
    MenuItem *item2 = menuitem_create();
    MenuItem *item3 = menuitem_create();
    menuitem_text(item0, TMEN_FIRST);
    menuitem_text(item1, TMEN_BACK);
    menuitem_text(item2, TMEN_NEXT);
    menuitem_text(item3, TMEN_LAST);
    menuitem_key(item0, ekKEY_F5, 0);
    menuitem_key(item1, ekKEY_F6, 0);
    menuitem_key(item2, ekKEY_F7, 0);
    menuitem_key(item3, ekKEY_F8, 0);
    menu_item(menu, item0);
    menu_item(menu, item1);
    menu_item(menu, item2);
    menu_item(menu, item3);
    ctrl_first_item(ctrl, item0);
    ctrl_back_item(ctrl, item1);
    ctrl_next_item(ctrl, item2);
    ctrl_last_item(ctrl, item3);
    return menu;
}

/*-----*/

static Menu *i_view(Ctrl *ctrl)
{
    Menu *menu = menu_create();
    MenuItem *item0 = menuitem_create();
    unref(ctrl);
    menuitem_text(item0, TMEN_LOGIN_PANEL);
    menuitem_image(item0, (const Image*)SETTINGS16_PNG);
    menu_item(menu, item0);
    ctrl_setting_item(ctrl, item0);
    return menu;
}

/*-----*/

```

```

static Menu *i_server(Ctrl *ctrl)
{
    Menu *menu = menu_create();
    MenuItem *item0 = menuitem_create();
    MenuItem *item1 = menuitem_create();
    menuitem_text(item0, TMEN_LOGIN);
    menuitem_text(item1, TMEN_LOGOUT);
    menu_item(menu, item0);
    menu_item(menu, item1);
    ctrl_login_item(ctrl, item0);
    ctrl_logout_item(ctrl, item1);
    return menu;
}

/*-----*/

static Menu *i_language(Ctrl *ctrl)
{
    Menu *menu = menu_create();
    MenuItem *item0 = menuitem_create();
    MenuItem *item1 = menuitem_create();
    MenuItem *item2 = menuitem_create();
    MenuItem *item3 = menuitem_create();
    MenuItem *item4 = menuitem_create();
    MenuItem *item5 = menuitem_create();
    MenuItem *item6 = menuitem_create();
    menuitem_text(item0, ENGLISH);
    menuitem_text(item1, SPANISH);
    menuitem_text(item2, PORTUGUESE);
    menuitem_text(item3, ITALIAN);
    menuitem_text(item4, VIETNAMESE);
    menuitem_text(item5, RUSSIAN);
    menuitem_text(item6, JAPANESE);
    menuitem_image(item0, (const Image*)USA_PNG);
    menuitem_image(item1, (const Image*)SPAIN_PNG);
    menuitem_image(item2, (const Image*)PORTUGAL_PNG);
    menuitem_image(item3, (const Image*)ITALY_PNG);
    menuitem_image(item4, (const Image*)VIETNAM_PNG);
    menuitem_image(item5, (const Image*)RUSSIA_PNG);
    menuitem_image(item6, (const Image*)JAPAN_PNG);
    menu_item(menu, item0);
    menu_item(menu, item1);
    menu_item(menu, item2);
    menu_item(menu, item3);
    menu_item(menu, item4);
    menu_item(menu, item5);
    menu_item(menu, item6);
    ctrl_lang_menu(ctrl, menu);
    return menu;
}

```

```

/*-----*/
#if !defined (__APPLE__)
static Menu *i_help(Ctrl *ctrl)
{
    Menu *menu = menu_create();
    MenuItem *item0 = menuitem_create();
    menuitem_text(item0, TMEN_ABOUT);
    menuitem_image(item0, (const Image*)ABOUT_PNG);
    menu_item(menu, item0);
    ctrl_about_item(ctrl, item0);
    return menu;
}
#endif

/*-----*/

Menu *prmenu_create(Ctrl *ctrl)
{
    Menu *menu = menu_create();
    MenuItem *item1 = menuitem_create();
    MenuItem *item2 = menuitem_create();
    MenuItem *item3 = menuitem_create();
    MenuItem *item4 = menuitem_create();
    MenuItem *item5 = menuitem_create();
    Menu *submenu1 = i_file(ctrl);
    Menu *submenu2 = i_navigate(ctrl);
    Menu *submenu3 = i_view(ctrl);
    Menu *submenu4 = i_server(ctrl);
    Menu *submenu5 = i_language(ctrl);

#if defined (__APPLE__)
    {
        MenuItem *item0 = menuitem_create();
        Menu *submenu0 = i_app(ctrl);
        menuitem_text(item1, "");
        menuitem_submenu(item0, &submenu0);
        menu_item(menu, item0);
    }
#endif

    menuitem_text(item1, TMEN_FILE);
    menuitem_text(item2, TMEN_NAVIGATE);
    menuitem_text(item3, TMEN_VIEW);
    menuitem_text(item4, TMEN_SERVER);
    menuitem_text(item5, LANGUAGE);
    menuitem_submenu(item1, &submenu1);
    menuitem_submenu(item2, &submenu2);
    menuitem_submenu(item3, &submenu3);
    menuitem_submenu(item4, &submenu4);
    menuitem_submenu(item5, &submenu5);
}

```



```

    menu_item(menu, item1);
    menu_item(menu, item2);
    menu_item(menu, item3);
    menu_item(menu, item4);
    menu_item(menu, item5);

    #if !defined (__APPLE__)
    {
        MenuItem *item6 = menuitem_create();
        Menu *submenu6 = i_help(ctrl);
        menuitem_text(item6, TMEN_HELP);
        menuitem_submenu(item6, &submenu6);
        menu_item(menu, item6);
    }
#endif
    return menu;
}

```

Listing 26.30: demo/products/prctrl.c

```

/* Products Controller */

#include "prctrl.h"
#include "prmodel.h"
#include "res_products.h"
#include <nappgui.h>
#include <inet/httpreq.h>
#include <inet/json.h>

typedef enum _status_t
{
    ekWAIT_LOGIN,
    ekIN_LOGIN,
    ekERR_LOGIN,
    ekOK_LOGIN
} status_t;

typedef struct _user_t User;
typedef struct _ujson_t UJson;

struct _user_t
{
    String *name;
    String *mail;
    Image *image64;
};

struct _ujson_t
{
    int32_t code;
    User data;
}

```

```

};

struct _ctrl_t
{
    Model *model;
    status_t status;
    wserv_t err;
    uint32_t selected;
    real32_t stats[12];
    UJson *ujson;
    Window *window;
    Layout *main_layout;
    Layout *status_layout;
    Cell *image_cell;
    Cell *first_cell;
    Cell *back_cell;
    Cell *next_cell;
    Cell *last_cell;
    Cell *add_cell;
    Cell *minus_cell;
    Cell *filter_cell;
    Cell *slider_cell;
    Cell *counter_cell;
    Cell *code_cell;
    Cell *desc_cell;
    Cell *price_cell;
    Cell *lang_cell;
    Cell *setting_cell;
    Cell *user_cell;
    Cell *pass_cell;
    Cell *login_cell;
    Cell *logout_cell;
    Cell *stats_cell;
    Panel *login_panel;
    Menu *lang_menu;
    MenuItem *import_item;
    MenuItem *export_item;
    MenuItem *first_item;
    MenuItem *back_item;
    MenuItem *next_item;
    MenuItem *last_item;
    MenuItem *setting_item;
    MenuItem *login_item;
    MenuItem *logout_item;
};

/*-----*/

static real32_t i_MAX_STATS = 20.f;

/*-----*/

```

```

Ctrl *ctrl_create(Model *model)
{
    Ctrl *ctrl = heap_new0(Ctrl);
    ctrl->model = model;
    ctrl->status = ekWAIT_LOGIN;
    ctrl->selected = 0;
    dbind(User, String*, name);
    dbind(User, String*, mail);
    dbind(User, Image*, image64);
    dbind(UJson, int32_t, code);
    dbind(UJson, User, data);
    return ctrl;
}

/*-----*/

void ctrl_destroy(Ctrl **ctrl)
{
    heap_delete(ctrl, Ctrl);
}

/*-----*/

void ctrl_main_layout(Ctrl *ctrl, Layout *layout)
{
    model_layout(layout);
    ctrl->main_layout = layout;
}

/*-----*/

void ctrl_status_layout(Ctrl *ctrl, Layout *layout)
{
    ctrl->status_layout = layout;
}

/*-----*/

static void i_update_product(Ctrl *ctrl)
{
    uint32_t total = model_count(ctrl->model);
    bool_t enabled = FALSE;
    bool_t is_first = (total == 0 || ctrl->selected == 0) ? TRUE : FALSE;
    bool_t is_last = (total == 0 || ctrl->selected == (total - 1)) ? TRUE :
        ↪ FALSE;
    Slider *slider = cell_slider(ctrl->slider_cell);
    Label *counter = cell_label(ctrl->counter_cell);
    Product *product = NULL;

    if (total > 0)

```

```

{
    char_t msg[64];
    uint32_t i, n = sizeof(ctrl->stats) / sizeof(real32_t);
    View *vstats = cell_view(ctrl->stats_cell);
    product = model_product(ctrl->model, ctrl->selected);
    bstd_sprintf(msg, 64, "[%d/%d]", ctrl->selected + 1, total);
    label_text(counter, msg);
    slider_value(slider, (real32_t)ctrl->selected / (real32_t)(total > 1 ?
        ↪ total - 1 : 1));
    enabled = TRUE;
    for (i = 0; i < n; ++i)
        ctrl->stats[i] = bmath_randf(2.f, i_MAX_STATS - 2.f);
    view_update(vstats);
}
else
{
    label_text(counter, "[0/0]");
    slider_value(slider, 0.f);
    enabled = FALSE;
}

layout_dbind_obj(ctrl->main_layout, product, Product);
cell_enabled(ctrl->add_cell, enabled);
cell_enabled(ctrl->minus_cell, enabled);
cell_enabled(ctrl->slider_cell, enabled);
cell_enabled(ctrl->filter_cell, enabled);
cell_enabled(ctrl->first_cell, !is_first);
cell_enabled(ctrl->back_cell, !is_first);
cell_enabled(ctrl->next_cell, !is_last);
cell_enabled(ctrl->last_cell, !is_last);
menuitem_enabled(ctrl->first_item, !is_first);
menuitem_enabled(ctrl->back_item, !is_first);
menuitem_enabled(ctrl->next_item, !is_last);
menuitem_enabled(ctrl->last_item, !is_last);
}

/*-----*/

static void i_status(Ctrl *ctrl)
{
    ImageView *view = layout_get_imageview(ctrl->status_layout, 0, 0);
    Label *label = layout_get_label(ctrl->status_layout, 1, 0);

    switch (ctrl->status) {
    case ekWAIT_LOGIN:
        imageview_image(view, (const Image*)LOGIN16_PNG);
        label_text(label, WAIT_LOGIN);
        break;

    case ekIN_LOGIN:
        imageview_image(view, (const Image*)SPIN_GIF);

```

```

        label_text(label, IN_LOGIN);
        break;

    case ekERR_LOGIN:
        imageview_image(view, (const Image*)ERROR_PNG);
        switch (ctrl->err) {
            case ekWS_CONNECT:
                label_text(label, ERR_CONNECT);
                break;
            case ekWS_JSON:
                label_text(label, ERR_JSON);
                break;
            case ekWS_ACCESS:
                label_text(label, ERR_ACCESS);
                break;
            case ekWS_OK:
                cassert_default();
            }
            break;

    case ekOK_LOGIN:
        imageview_image(view, (const Image*)OK_PNG);
        label_text(label, OK_LOGIN);
        break;

    cassert_default();
}

/*-----*/

void ctrl_run(Ctrl *ctrl)
{
    Button *setting_button;
    PopUp *lang_popup;
    MenuItem *lang_item;
    uint32_t lang_index;
    ctrl->status = ekWAIT_LOGIN;
    setting_button = cell_button(ctrl->setting_cell);
    layout_show_col(ctrl->main_layout, 1, TRUE);
    button_state(setting_button, ekGUI_ON);
    menuitem_state(ctrl->setting_item, ekGUI_ON);
    lang_popup = cell_popup(ctrl->lang_cell);
    lang_index = popup_get_selected(lang_popup);
    lang_item = menu_get_item(ctrl->lang_menu, lang_index);
    menuitem_state(lang_item, ekGUI_ON);
    menuitem_enabled(ctrl->login_item, TRUE);
    menuitem_enabled(ctrl->logout_item, FALSE);
    menuitem_enabled(ctrl->import_item, FALSE);
    menuitem_enabled(ctrl->export_item, FALSE);
    i_status(ctrl);
}

```

```

window_focus(ctrl->window, cell_control(ctrl->user_cell));
i_update_product(ctrl);
window_defbutton(ctrl->window, cell_button(ctrl->login_cell));
}

/*-----*/

static void i_OnFirst(Ctrl *ctrl, Event *e)
{
    ctrl->selected = 0;
    i_update_product(ctrl);
    unref(e);
}

/*-----*/

static void i_OnImport(Ctrl *ctrl, Event *e)
{
    const char_t *type[] = { "dbp" };
    const char_t *file = comwin_open_file(ctrl->window, type, 1, NULL);
    if (file != NULL)
    {
        ferror_t err;
        if (model_import(ctrl->model, file, &err) == TRUE)
            i_update_product(ctrl);
    }
    unref(e);
}

/*-----*/

void ctrl_import_item(Ctrl *ctrl, MenuItem *item)
{
    ctrl->import_item = item;
    menuitem_OnClick(item, listener(ctrl, i_OnImport, Ctrl));
}

/*-----*/

static void i_OnExport(Ctrl *ctrl, Event *e)
{
    const char_t *type[] = { "dbp" };
    const char_t *file = comwin_save_file(ctrl->window, type, 1, NULL);
    if (file != NULL)
    {
        ferror_t err;
        model_export(ctrl->model, file, &err);
    }
    unref(e);
}

```

```

/*-----*/

void ctrl_export_item(Ctrl *ctrl, MenuItem *item)
{
    ctrl->export_item = item;
    menuitem_OnClick(item, listener(ctrl, i_OnExport, Ctrl));
}

/*-----*/

static void i_OnImgDraw(Ctrl *ctrl, Event *e)
{
    const EvDraw *params = event_params(e, EvDraw);
    const Image *image = gui_image(EDIT_PNG);
    uint32_t w = image_width(image);
    uint32_t h = image_height(image);
    draw_image(params->ctx, image, params->width - w - 10, params->height - h -
        ↪ 10);
    unref(ctrl);
}

/*-----*/

static void i_OnImgClick(Ctrl *ctrl, Event *e)
{
    const char_t *type[] = { "png", "jpg" };
    const char_t *file = comwin_open_file(ctrl->window, type, 2, NULL);
    if (file != NULL)
    {
        Image *image = image_from_file(file, NULL);
        if (image != NULL)
        {
            ImageView *view = cell_imageview(ctrl->image_cell);
            imageview_image(view, image);
            image_destroy(&image);
        }
    }
    unref(e);
}

/*-----*/

void ctrl_image_cell(Ctrl *ctrl, Cell *cell)
{
    ImageView *view = cell_imageview(cell);
    model_image(cell);
    imageview_OnOverDraw(view, listener(ctrl, i_OnImgDraw, Ctrl));
    imageview_OnClick(view, listener(ctrl, i_OnImgClick, Ctrl));
    ctrl->image_cell = cell;
}

```

```

/*-----*/

void ctrl_first_cell(Ctrl *ctrl, Cell *cell)
{
    Button *button = cell_button(cell);
    button_OnClick(button, listener(ctrl, i_OnFirst, Ctrl));
    ctrl->first_cell = cell;
}

/*-----*/

void ctrl_first_item(Ctrl *ctrl, MenuItem *item)
{
    menuitem_OnClick(item, listener(ctrl, i_OnFirst, Ctrl));
    ctrl->first_item = item;
}

/*-----*/

static void i_OnBack(Ctrl *ctrl, Event *e)
{
    if (ctrl->selected > 0)
    {
        ctrl->selected -= 1;
        i_update_product(ctrl);
    }
    unref(e);
}

/*-----*/

void ctrl_back_cell(Ctrl *ctrl, Cell *cell)
{
    Button *button = cell_button(cell);
    button_OnClick(button, listener(ctrl, i_OnBack, Ctrl));
    ctrl->back_cell = cell;
}

/*-----*/

void ctrl_back_item(Ctrl *ctrl, MenuItem *item)
{
    menuitem_OnClick(item, listener(ctrl, i_OnBack, Ctrl));
    ctrl->back_item = item;
}

/*-----*/

static void i_OnNext(Ctrl *ctrl, Event *e)
{
    uint32_t total = model_count(ctrl->model);
}

```



```

    if (ctrl->selected < total - 1)
    {
        ctrl->selected += 1;
        i_update_product(ctrl);
    }
    unref(e);
}

/*-----*/

void ctrl_next_cell(Ctrl *ctrl, Cell *cell)
{
    Button *button = cell_button(cell);
    button_OnClick(button, listener(ctrl, i_OnNext, Ctrl));
    ctrl->next_cell = cell;
}

/*-----*/

void ctrl_next_item(Ctrl *ctrl, MenuItem *item)
{
    menuitem_OnClick(item, listener(ctrl, i_OnNext, Ctrl));
    ctrl->next_item = item;
}

/*-----*/

static void i_OnLast(Ctrl *ctrl, Event *e)
{
    uint32_t total = model_count(ctrl->model);
    if (ctrl->selected < total - 1)
    {
        ctrl->selected = total - 1;
        i_update_product(ctrl);
    }
    unref(e);
}

/*-----*/

void ctrl_last_cell(Ctrl *ctrl, Cell *cell)
{
    Button *button = cell_button(cell);
    button_OnClick(button, listener(ctrl, i_OnLast, Ctrl));
    ctrl->last_cell = cell;
}

/*-----*/

void ctrl_last_item(Ctrl *ctrl, MenuItem *item)
{

```

```

    menuitem_OnClick(item, listener(ctrl, i_OnLast, Ctrl));
    ctrl->last_item = item;
}

/*-----*/

static void i_OnAdd(Ctrl *ctrl, Event *e)
{
    model_add(ctrl->model);
    ctrl->selected = model_count(ctrl->model) - 1;
    i_update_product(ctrl);
    window_focus(ctrl->window, cell_control(ctrl->code_cell));
    unref(e);
}

/*-----*/

void ctrl_add_cell(Ctrl *ctrl, Cell *cell)
{
    Button *button = cell_button(cell);
    button_OnClick(button, listener(ctrl, i_OnAdd, Ctrl));
    ctrl->add_cell = cell;
}

/*-----*/

static void i_OnDelete(Ctrl *ctrl, Event *e)
{
    model_delete(ctrl->model, ctrl->selected);
    if (ctrl->selected == model_count(ctrl->model) && ctrl->selected > 0)
        ctrl->selected -= 1;
    i_update_product(ctrl);
    unref(e);
}

/*-----*/

void ctrl_minus_cell(Ctrl *ctrl, Cell *cell)
{
    Button *button = cell_button(cell);
    button_OnClick(button, listener(ctrl, i_OnDelete, Ctrl));
    ctrl->minus_cell = cell;
}

/*-----*/

static void i_OnFilter(Ctrl *ctrl, Event *e)
{
    const EvText *params = event_params(e, EvText);
    EvTextFilter *result = event_result(e, EvTextFilter);
    Combo *combo = event_sender(e, Combo);

```

```

uint32_t color = color_rgb(255, 0, 0);

if (unicode_nchars(params->text, ekUTF8) >= 3)
{
    if (model_filter(ctrl->model, params->text) == TRUE)
    {
        color = UINT32_MAX;
        ctrl->selected = 0;
        i_update_product(ctrl);
    }
}

combo_color(combo, color);
result->apply = FALSE;
}

/*-----*/

static void i_OnFilterEnd(Ctrl *ctrl, Event *e)
{
    const EvText *params = event_params(e, EvText);
    Combo *combo = event_sender(e, Combo);

    if (model_filter(ctrl->model, params->text) == TRUE)
        combo_ins_elem(combo, 0, params->text, NULL);
    else
        combo_text(combo, "");

    ctrl->selected = 0;
    i_update_product(ctrl);

    combo_color(combo, UINT32_MAX);
}

/*-----*/

void ctrl_filter_cell(Ctrl *ctrl, Cell *cell)
{
    Combo *combo = cell_combo(cell);
    combo_OnFilter(combo, listener(ctrl, i_OnFilter, Ctrl));
    combo_OnChange(combo, listener(ctrl, i_OnFilterEnd, Ctrl));
    ctrl->filter_cell = cell;
}

/*-----*/

static void i_OnSlider(Ctrl *ctrl, Event *e)
{
    const EvSlider *params = event_params(e, EvSlider);
    uint32_t total = model_count(ctrl->model);
    uint32_t selected = 0;

```

```

    if (total > 0)
        selected = (uint32_t)((real32_t)(total - 1) * params->pos);

    if (selected != ctrl->selected)
    {
        ctrl->selected = selected;
        i_update_product(ctrl);
    }
}

/*-----*/

void ctrl_slider_cell(Ctrl *ctrl, Cell *cell)
{
    Slider *slider = cell_slider(cell);
    slider_OnMoved(slider, listener(ctrl, i_OnSlider, Ctrl));
    ctrl->slider_cell = cell;
}

/*-----*/

void ctrl_counter_cell(Ctrl *ctrl, Cell *cell)
{
    ctrl->counter_cell = cell;
}

/*-----*/

void ctrl_type_cell(Ctrl *ctrl, Cell *cell)
{
    model_type(cell);
    unref(ctrl);
}

/*-----*/

void ctrl_code_cell(Ctrl *ctrl, Cell *cell)
{
    model_code(cell);
    ctrl->code_cell = cell;
}

/*-----*/

void ctrl_desc_cell(Ctrl *ctrl, Cell *cell)
{
    model_desc(cell);
    ctrl->desc_cell = cell;
}

/*-----*/

```

```

void ctrl_price_cell(Ctrl *ctrl, Cell *cell)
{
    model_price(cell);
    ctrl->price_cell = cell;
}

/*-----*/

void ctrl_user_cell(Ctrl *ctrl, Cell *cell)
{
    ctrl->user_cell = cell;
}

/*-----*/

void ctrl_pass_cell(Ctrl *ctrl, Cell *cell)
{
    ctrl->pass_cell = cell;
}

/*-----*/

void ctrl_login_panel(Ctrl *ctrl, Panel *panel)
{
    ctrl->login_panel = panel;
}

/*-----*/

static UJson *i_user_webserv(const char_t *user, const char_t *pass, wserv_t *
    ↪ ret)
{
    Http *http = NULL;
    String *path = NULL;
    UJson *ujson = NULL;

    *ret = ekWS_OK;
    if (str_empty_c(user) || str_empty_c(pass))
    {
        *ret = ekWS_ACCESS;
        return NULL;
    }

    http = http_create("serv.nappgui.com", 80);
    path = str_printf("/duser.php?user=%s&pass=%s", user, pass);
    if (http_get(http, tc(path), NULL, 0, NULL) == TRUE)
    {
        uint32_t status = http_response_status(http);
        if (status >= 200 && status <= 299)
        {

```

```

Stream *stm = stm_memory(4096);
http_response_body(http, stm, NULL);
ujson = json_read(stm, NULL, UJson);

if (!ujson)
{
    *ret = ekWS_JSON;
}
else if (ujson->code != 0)
{
    json_destroy(&ujson, UJson);
    *ret = ekWS_ACCESS;
}

stm_close(&stm);
}
else
{
    *ret = ekWS_ACCESS;
}
}

str_destroy(&path);
http_destroy(&http);
return ujson;
}

/*-----*/

static uint32_t i_login_begin(Ctrl *ctrl)
{
    Edit *user = cell_edit(ctrl->user_cell);
    Edit *pass = cell_edit(ctrl->pass_cell);
    wserv_t ret = ekWS_OK;
    ctrl->ujson = i_user_webserv(edit_get_text(user), edit_get_text(pass), &ret
    ↪ );
    if (ctrl->ujson != NULL)
    {
        ret = model_webserv(ctrl->model);
        if (ret != ekWS_OK)
            json_destroy(&ctrl->ujson, UJson);
    }

    return (uint32_t)ret;
}

/*-----*/

static void i_login_end(Ctrl *ctrl, const uint32_t rvalue)
{
    wserv_t ret = (wserv_t)rvalue;

```

```

if (ret == ekWS_OK)
{
    Layout *layout = panel_get_layout(ctrl->login_panel, 1);
    ImageView *view = layout_get_imageview(layout, 0, 0);
    Label *label0 = layout_get_label(layout, 0, 1);
    Label *label1 = layout_get_label(layout, 0, 2);
    window_defbutton(ctrl->window, NULL);
    imageview_image(view, ctrl->ujson->data.image64);
    label_text(label0, tc(ctrl->ujson->data.name));
    label_text(label1, tc(ctrl->ujson->data.mail));
    menuitem_enabled(ctrl->login_item, FALSE);
    menuitem_enabled(ctrl->logout_item, TRUE);
    menuitem_enabled(ctrl->import_item, TRUE);
    menuitem_enabled(ctrl->export_item, TRUE);
    panel_visible_layout(ctrl->login_panel, 1);
    ctrl->status = ekOK_LOGIN;
    ctrl->selected = 0;
    i_update_product(ctrl);
    json_destroy(&ctrl->ujson, UJson);
    window_focus(ctrl->window, cell_control(ctrl->code_cell));
    panel_update(ctrl->login_panel);
}
else
{
    cassert(ctrl->ujson == NULL);
    ctrl->status = ekERR_LOGIN;
    ctrl->err = ret;
}

i_status(ctrl);
}

/*-----*/

static void i_OnLogin(Ctrl *ctrl, Event *e)
{
    if (ctrl->status != ekIN_LOGIN)
    {
        ctrl->status = ekIN_LOGIN;
        i_status(ctrl);
        osapp_task(ctrl, 0, i_login_begin, NULL, i_login_end, Ctrl);
    }

    unref(e);
}

/*-----*/

void ctrl_login_cell(Ctrl *ctrl, Cell *cell)
{
    Button *button = cell_button(cell);

```

```

    button_OnClick(button, listener(ctrl, i_OnLogin, Ctrl));
    ctrl->login_cell = cell;
}

/*-----*/

void ctrl_login_item(Ctrl *ctrl, MenuItem *item)
{
    menuitem_OnClick(item, listener(ctrl, i_OnLogin, Ctrl));
    ctrl->login_item = item;
}

/*-----*/

static void i_OnLogout(Ctrl *ctrl, Event *e)
{
    Edit *edit0 = cell_edit(ctrl->user_cell);
    Edit *edit1 = cell_edit(ctrl->pass_cell);
    model_clear(ctrl->model);
    edit_text(edit0, "");
    edit_text(edit1, "");
    menuitem_enabled(ctrl->login_item, TRUE);
    menuitem_enabled(ctrl->logout_item, FALSE);
    menuitem_enabled(ctrl->import_item, FALSE);
    menuitem_enabled(ctrl->export_item, FALSE);
    ctrl->status = ekWAIT_LOGIN;
    panel_visible_layout(ctrl->login_panel, 0);
    i_update_product(ctrl);
    i_status(ctrl);
    panel_update(ctrl->login_panel);
    window_focus(ctrl->window, cell_control(ctrl->user_cell));
    window_defbutton(ctrl->window, cell_button(ctrl->login_cell));
    unref(e);
}

/*-----*/

void ctrl_logout_cell(Ctrl *ctrl, Cell *cell)
{
    Button *button = cell_button(cell);
    button_OnClick(button, listener(ctrl, i_OnLogout, Ctrl));
    ctrl->logout_cell = cell;
}

/*-----*/

void ctrl_logout_item(Ctrl *ctrl, MenuItem *item)
{
    menuitem_OnClick(item, listener(ctrl, i_OnLogout, Ctrl));
    ctrl->logout_item = item;
}

```



```

/*-----*/

static void i_OnSetting(Ctrl *ctrl, Event *e)
{
    gui_state_t state = ekGUI_ON;
    if (event_type(e) == ekGUI_EVENT_BUTTON)
    {
        const EvButton *params = event_params(e, EvButton);
        state = params->state;
    }
    else
    {
        Button *button = cell_button(ctrl->setting_cell);
        cassert(event_type(e) == ekGUI_EVENT_MENU);
        state = button_get_state(button);
        state = state == ekGUI_ON ? ekGUI_OFF : ekGUI_ON;
        button_state(button, state);
    }

    menuitem_state(ctrl->setting_item, state);
    layout_show_col(ctrl->main_layout, 1, state == ekGUI_ON ? TRUE : FALSE);
    layout_update(ctrl->main_layout);
}

/*-----*/

void ctrl_setting_cell(Ctrl *ctrl, Cell *cell)
{
    Button *button = cell_button(cell);
    button_OnClick(button, listener(ctrl, i_OnSetting, Ctrl));
    ctrl->setting_cell = cell;
}

/*-----*/

void ctrl_setting_item(Ctrl *ctrl, MenuItem *item)
{
    menuitem_OnClick(item, listener(ctrl, i_OnSetting, Ctrl));
    ctrl->setting_item = item;
}

/*-----*/

static void i_OnStats(Ctrl *ctrl, Event *e)
{
    const EvDraw *params = event_params(e, EvDraw);
    uint32_t i, n = sizeof(ctrl->stats) / sizeof(real32_t);
    real32_t p = 10.f, x = p, y0 = params->height - p;
    real32_t w = (params->width - p * 2) / n;
    real32_t h = params->height - p * 2;
}

```

```

real32_t avg = 0, pavg;
char_t tavg[16];
color_t c[2];
real32_t stop[2] = {0, 1};
c[0] = kHOLDER;
c[1] = gui_view_color();

draw_fill_linear(params->ctx, c, stop, 2, 0, p, 0, params->height - p + 1);

for (i = 0; i < n; ++i)
{
    real32_t hr = h * (ctrl->stats[i] / i_MAX_STATS);
    real32_t y = p + h - hr;
    draw_rect(params->ctx, ekFILL, x, y, w - 2, hr);
    avg += ctrl->stats[i];
    x += w;
}

avg /= n;
pavg = h * (avg / i_MAX_STATS);
pavg = p + h - pavg;
bstd_sprintf(tavg, sizeof(tavg), "%.2f", avg);
draw_text_color(params->ctx, kTXTRED);
draw_line_color(params->ctx, kTXTRED);
draw_line(params->ctx, p - 2, pavg, params->width - p, pavg);
draw_line_color(params->ctx, gui_label_color());
draw_line(params->ctx, p - 2, y0 + 2, params->width - p, y0 + 2);
draw_line(params->ctx, p - 2, y0 + 2, p - 2, p);
draw_text(params->ctx, tavg, p, pavg);
}

/*-----*/

void ctrl_stats_cell(Ctrl *ctrl, Cell *cell)
{
    View *view = cell_view(cell);
    view_OnDraw(view, listener(ctrl, i_OnStats, Ctrl));
    ctrl->stats_cell = cell;
}

/*-----*/

static void i_OnLang(Ctrl *ctrl, Event *e)
{
    MenuItem *item = NULL;
    uint32_t lang_id = 0;
    static const char_t *LANGS[] = { "en_US", "es_ES", "pt_PT", "it_IT", "vi_VN",
    ↪  ", "ru_RU", "ja_JP" };
    if (event_type(e) == ekGUI_EVENT_POPUP)
    {
        const EvButton *params = event_params(e, EvButton);

```

```

        item = menu_get_item(ctrl->lang_menu, params->index);
        lang_id = params->index;
    }
    else
    {
        const EvMenu *params = event_params(e, EvMenu);
        PopUp *popup = cell_popup(ctrl->lang_cell);
        cassert(event_type(e) == ekGUI_EVENT_MENU);
        popup_selected(popup, params->index);
        item = event_sender(e, MenuItem);
        lang_id = params->index;
    }

    menu_off_items(ctrl->lang_menu);
    menuitem_state(item, ekGUI_ON);
    gui_language(LANGS[lang_id]);
}

/*-----*/

void ctrl_lang_cell(Ctrl *ctrl, Cell *cell)
{
    PopUp *popup = cell_popup(cell);
    popup_OnSelect(popup, listener(ctrl, i_OnLang, Ctrl));
    ctrl->lang_cell = cell;
}

/*-----*/

void ctrl_lang_menu(Ctrl *ctrl, Menu *menu)
{
    uint32_t i, n = menu_size(menu);
    for (i = 0; i < n; ++i)
    {
        MenuItem *item = menu_get_item(menu, i);
        menuitem_OnClick(item, listener(ctrl, i_OnLang, Ctrl));
    }
    ctrl->lang_menu = menu;
}

/*-----*/

static void i_OnExit(Ctrl *ctrl, Event *e)
{
    osapp_finish();
    unref(ctrl);
    unref(e);
}

/*-----*/

```

```

void ctrl_exit_item(Ctrl *ctrl, MenuItem *item)
{
    menuitem_OnClick(item, listener(ctrl, i_OnExit, Ctrl));
}

/*-----*/

static void i_OnAbout(Ctrl *ctrl, Event *e)
{
    unref(ctrl);
    unref(e);
    osapp_open_url("https://nappgui.com/en/demo/products.html");
}

/*-----*/

void ctrl_about_item(Ctrl *ctrl, MenuItem *item)
{
    menuitem_OnClick(item, listener(ctrl, i_OnAbout, Ctrl));
}

/*-----*/

void ctrl_window(Ctrl *ctrl, Window *window)
{
    window_OnClose(window, listener(ctrl, i_OnExit, Ctrl));
    ctrl->window = window;
}

/*-----*/

void ctrl_theme_images(Ctrl *ctrl)
{
    bool_t dark = gui_dark_mode();
    button_image(cell_button(ctrl->first_cell), (const Image*)(dark ?
    ↪ FIRSTD_PNG : FIRST_PNG));
    button_image(cell_button(ctrl->back_cell), (const Image*)(dark ? BACKD_PNG
    ↪ : BACK_PNG));
    button_image(cell_button(ctrl->next_cell), (const Image*)(dark ? NEXTD_PNG
    ↪ : NEXT_PNG));
    button_image(cell_button(ctrl->last_cell), (const Image*)(dark ? LASTD_PNG
    ↪ : LAST_PNG));
    button_image(cell_button(ctrl->add_cell), (const Image*)ADD_PNG);
    button_image(cell_button(ctrl->minus_cell), (const Image*)MINUS_PNG);
    button_image(cell_button(ctrl->setting_cell), (const Image*)SETTINGS_PNG);
    button_image(cell_button(ctrl->login_cell), (const Image*)LOGIN16_PNG);
    button_image(cell_button(ctrl->logout_cell), (const Image*)(dark ?
    ↪ LOGOUT16D_PNG : LOGOUT16_PNG));
    menuitem_image(ctrl->import_item, (const Image*)OPEN_PNG);
    menuitem_image(ctrl->export_item, (const Image*)(dark ? SAVED_PNG :
    ↪ SAVE_PNG));
}

```

```
    menuitem_image(ctrl->first_item, (const Image*)(dark ? FIRST16D_PNG :  
        ↪ FIRST16_PNG));  
    menuitem_image(ctrl->back_item, (const Image*)(dark ? BACK16D_PNG :  
        ↪ BACK16_PNG));  
    menuitem_image(ctrl->next_item, (const Image*)(dark ? NEXT16D_PNG :  
        ↪ NEXT16_PNG));  
    menuitem_image(ctrl->last_item, (const Image*)(dark ? LAST16D_PNG :  
        ↪ LAST16_PNG));  
    menuitem_image(ctrl->login_item, (const Image*)LOGIN16_PNG);  
    menuitem_image(ctrl->logout_item, (const Image*)(dark ? LOGOUT16D_PNG :  
        ↪ LOGOUT16_PNG));  
}
```

Hello GUI!

27.1	Hello GUI!	526
27.2	Hello Label!	526
27.3	Hello Button!	530
27.4	Hello PopUp and Combo!	533
27.5	Hello Edit and UpDown!	535
27.6	Hello TextSel and Clipboard!	543
27.7	Hello TextEditor!	549
27.8	Hello ListBox!	556
27.9	Hello Slider and Progress!	559
27.10	Hello TextView!	560
27.11	Hello TableView!	563
27.12	Hello SplitView!	570
27.13	Hello Modal Window!	572
27.14	Hello Overlay Window!	577
27.15	Hello Gui Binding!	583
27.16	Hello Struct Binding!	587
27.17	Hello Sublayout!	595
27.18	Hello Subpanel!	598
27.19	Hello Multi-layout!	599
27.20	Hello Scroll-Panel!	602
27.21	Hello Dynamic Layout!	603
27.22	Hello IP-Input!	618

27.1. Hello GUI!

GuiHello is an application, which by examples, shows “*Gui*” (page 305) library features for the creation of user interfaces. The **source code** is in folder `/demo/guihello` of the SDK distribution.

27.2. Hello Label!

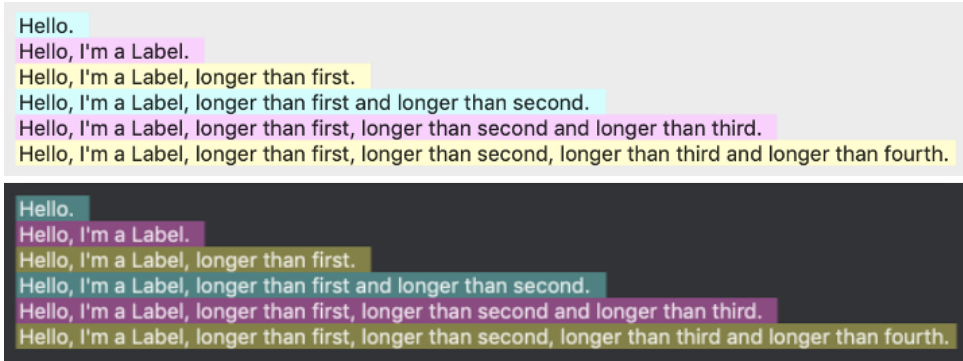

Figure 27.1: Label controls.

Listing 27.1: `demo/guihello/labels.c`

```

/* Labels basics */

#include "labels.h"
#include <gui/guiall.h>

/*-----*/

static const char_t *i_LABEL_01 = "Hello.";
static const char_t *i_LABEL_02 = "Hello, I'm a Label.";
static const char_t *i_LABEL_03 = "Hello, I'm a Label, longer than first.";
static const char_t *i_LABEL_04 = "Hello, I'm a Label, longer than first and
    ↪ longer than second.";
static const char_t *i_LABEL_05 = "Hello, I'm a Label, longer than first,
    ↪ longer than second and longer than third.";
static const char_t *i_LABEL_06 = "Hello, I'm a Label, longer than first,
    ↪ longer than second, longer than third and longer than fourth.";
static const char_t *i_LABEL_07 = "Mouse sensitive label";

/*-----*/

static void i_OnLayoutWidth(Layout *layout, Event *event)
{
    const EvButton *p = event_params(event, EvButton);
    real32_t width = 0;

```

```

switch (p->index)
{
case 0:
    width = 0;
    break;
case 1:
    width = 100;
    break;
case 2:
    width = 200;
    break;
case 3:
    width = 300;
    break;
case 4:
    width = 400;
    break;
    cassert_default();
}

layout_hsize(layout, 0, width);
layout_update(layout);
}

/*-----*/

static Popup *i_width_popup(Layout *layout)
{
    Popup *popup = popup_create();
    popup_add_elem(popup, "Natural", NULL);
    popup_add_elem(popup, "100px", NULL);
    popup_add_elem(popup, "200px", NULL);
    popup_add_elem(popup, "300px", NULL);
    popup_add_elem(popup, "400px", NULL);
    popup_OnSelect(popup, listener(layout, i_OnLayoutWidth, layout));
    return popup;
}

/*-----*/

Panel *labels_single_line(void)
{
    Panel *panel = panel_create();
    Layout *layout = layout_create(1, 7);
    Popup *popup = i_width_popup(layout);
    Label *label1 = label_create();
    Label *label2 = label_create();
    Label *label3 = label_create();
    Label *label4 = label_create();
    Label *label5 = label_create();
    Label *label6 = label_create();
}

```



```

color_t c1 = gui_alt_color(color_rgb(192, 255, 255), color_rgb(48, 112,
↪ 112));
color_t c2 = gui_alt_color(color_rgb(255, 192, 255), color_rgb(128, 48,
↪ 112));
color_t c3 = gui_alt_color(color_rgb(255, 255, 192), color_rgb(112, 112,
↪ 48));
label_text(label1, i_LABEL_01);
label_text(label2, i_LABEL_02);
label_text(label3, i_LABEL_03);
label_text(label4, i_LABEL_04);
label_text(label5, i_LABEL_05);
label_text(label6, i_LABEL_06);
label_bgcolor(label1, c1);
label_bgcolor(label2, c2);
label_bgcolor(label3, c3);
label_bgcolor(label4, c1);
label_bgcolor(label5, c2);
label_bgcolor(label6, c3);
layout_popup(layout, popup, 0, 0);
layout_label(layout, label1, 0, 1);
layout_label(layout, label2, 0, 2);
layout_label(layout, label3, 0, 3);
layout_label(layout, label4, 0, 4);
layout_label(layout, label5, 0, 5);
layout_label(layout, label6, 0, 6);
layout_vmargin(layout, 0, 5);
panel_layout(panel, layout);
return panel;
}

/*-----*/

Panel *labels_multi_line(void)
{
    Panel *panel = panel_create();
    Layout *layout = layout_create(1, 7);
    PopUp *popup = i_width_popup(layout);
    Label *label1 = label_multiline();
    Label *label2 = label_multiline();
    Label *label3 = label_multiline();
    Label *label4 = label_multiline();
    Label *label5 = label_multiline();
    Label *label6 = label_multiline();
    color_t c1 = gui_alt_color(color_rgb(192, 255, 255), color_rgb(48, 112,
↪ 112));
    color_t c2 = gui_alt_color(color_rgb(255, 192, 255), color_rgb(128, 48,
↪ 112));
    color_t c3 = gui_alt_color(color_rgb(255, 255, 192), color_rgb(112, 112,
↪ 48));
    label_text(label1, i_LABEL_01);
    label_text(label2, i_LABEL_02);

```

```

label_text(label3, i_LABEL_03);
label_text(label4, i_LABEL_04);
label_text(label5, i_LABEL_05);
label_text(label6, i_LABEL_06);
label_bgcolor(label1, c1);
label_bgcolor(label2, c2);
label_bgcolor(label3, c3);
label_bgcolor(label4, c1);
label_bgcolor(label5, c2);
label_bgcolor(label6, c3);
label_align(label4, ekLEFT);
label_align(label5, ekCENTER);
label_align(label6, ekRIGHT);
layout_popup(layout, popup, 0, 0);
layout_label(layout, label1, 0, 1);
layout_label(layout, label2, 0, 2);
layout_label(layout, label3, 0, 3);
layout_label(layout, label4, 0, 4);
layout_label(layout, label5, 0, 5);
layout_label(layout, label6, 0, 6);
layout_vmargin(layout, 0, 5);
panel_layout(panel, layout);
return panel;
}

/*-----*/

Panel *labels_mouse_over(void)
{
    Panel *panel = panel_create();
    Layout *layout = layout_create(1, 5);
    Font *font = font_system(20, ekFNORMAL | ekFPIXELS);
    Label *label1 = label_create();
    Label *label2 = label_create();
    Label *label3 = label_create();
    Label *label4 = label_create();
    Label *label5 = label_create();
    label_text(label1, i_LABEL_07);
    label_text(label2, i_LABEL_07);
    label_text(label3, i_LABEL_07);
    label_text(label4, i_LABEL_07);
    label_text(label5, i_LABEL_07);
    label_font(label1, font);
    label_font(label2, font);
    label_font(label3, font);
    label_font(label4, font);
    label_font(label5, font);
    label_color_over(label1, kCOLOR_RED);
    label_color_over(label2, kCOLOR_RED);
    label_color_over(label3, kCOLOR_RED);
    label_color_over(label4, kCOLOR_RED);
}

```

```

label_color_over(label5, kCOLOR_RED);
label_style_over(label1, ekFBOLD);
label_style_over(label2, ekFITALIC);
label_style_over(label3, ekFSTRIKEOUT);
label_style_over(label4, ekFUNDERLINE);
label_bgcolor_over(label5, kCOLOR_CYAN);
layout_label(layout, label1, 0, 0);
layout_label(layout, label2, 0, 1);
layout_label(layout, label3, 0, 2);
layout_label(layout, label4, 0, 3);
layout_label(layout, label5, 0, 4);
panel_layout(panel, layout);
font_destroy(&font);
return panel;
}

```

27.3. Hello Button!

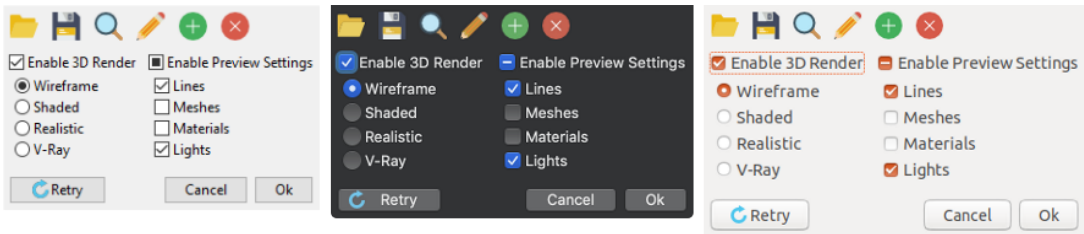

Figure 27.2: Button controls.

Listing 27.2: demo/guihello/buttons.c

```

/* Buttons demo */

#include "buttons.h"
#include "res_guihello.h"
#include <gui/guiall.h>

/*-----*/

static Layout *i_flatbuttons(void)
{
    Layout *layout = layout_create(6, 1);
    Button *button1 = button_flat();
    Button *button2 = button_flat();
    Button *button3 = button_flat();
    Button *button4 = button_flat();
    Button *button5 = button_flat();
    Button *button6 = button_flat();
    button_text(button1, "Open File");
    button_text(button2, "Save File");
}

```

```

    button_text(button3, "Search File");
    button_text(button4, "Edit File");
    button_text(button5, "Add File");
    button_text(button6, "Delete File");
    button_image(button1, gui_image(FOLDER24_PNG));
    button_image(button2, gui_image(DISK24_PNG));
    button_image(button3, gui_image(SEARCH24_PNG));
    button_image(button4, gui_image(EDIT24_PNG));
    button_image(button5, gui_image(PLUS24_PNG));
    button_image(button6, gui_image(ERROR24_PNG));
    layout_button(layout, button1, 0, 0);
    layout_button(layout, button2, 1, 0);
    layout_button(layout, button3, 2, 0);
    layout_button(layout, button4, 3, 0);
    layout_button(layout, button5, 4, 0);
    layout_button(layout, button6, 5, 0);
    return layout;
}

/*-----*/

static Layout *i_radios(void)
{
    Layout *layout = layout_create(1, 4);
    Button *radio1 = button_radio();
    Button *radio2 = button_radio();
    Button *radio3 = button_radio();
    Button *radio4 = button_radio();
    button_text(radio1, "&Wireframe");
    button_text(radio2, "&Shaded");
    button_text(radio3, "&Realistic");
    button_text(radio4, "&V-Ray");
    button_state(radio1, ekGUI_ON);
    layout_button(layout, radio1, 0, 0);
    layout_button(layout, radio2, 0, 1);
    layout_button(layout, radio3, 0, 2);
    layout_button(layout, radio4, 0, 3);
    layout_margin(layout, 5);
    layout_vmargen(layout, 0, 3);
    layout_vmargen(layout, 1, 3);
    layout_vmargen(layout, 2, 3);
    return layout;
}

/*-----*/

static Layout *i_checks(void)
{
    Layout *layout = layout_create(1, 4);
    Button *check1 = button_check();
    Button *check2 = button_check();

```

```

    Button *check3 = button_check();
    Button *check4 = button_check();
    button_text(check1, "&Lines");
    button_text(check2, "M&eshes");
    button_text(check3, "M&aterials");
    button_text(check4, "L&ights");
    button_state(check1, ekGUI_ON);
    button_state(check2, ekGUI_OFF);
    button_state(check3, ekGUI_OFF);
    button_state(check4, ekGUI_ON);
    layout_button(layout, check1, 0, 0);
    layout_button(layout, check2, 0, 1);
    layout_button(layout, check3, 0, 2);
    layout_button(layout, check4, 0, 3);
    layout_margin(layout, 5);
    layout_vmargin(layout, 0, 3);
    layout_vmargin(layout, 1, 3);
    layout_vmargin(layout, 2, 3);
    return layout;
}

/*-----*/

static Layout *i_pushes(Button **defbutton)
{
    Layout *layout = layout_create(4, 1);
    Button *button1 = button_push();
    Button *button2 = button_push();
    Button *button3 = button_push();
    button_text(button1, "Re&try");
    button_text(button2, "&Cancel");
    button_text(button3, "&Ok");
    button_image(button1, gui_image(RETRY_PNG));
    layout_button(layout, button1, 0, 0);
    layout_button(layout, button2, 2, 0);
    layout_button(layout, button3, 3, 0);
    layout_hmargin(layout, 2, 5);
    layout_hexpand(layout, 1);
    *defbutton = button1;
    return layout;
}

/*-----*/

static Layout *i_buttons(Button **defbutton)
{
    Layout *layout = layout_create(1, 3);
    Layout *layout1 = i_flatbuttons();
    Layout *layout2 = layout_create(2, 2);
    Layout *layout3 = i_radios();
    Layout *layout4 = i_checks();

```

```

Layout *layout5 = i_pushes(defbutton);
Button *check1 = button_check();
Button *check2 = button_check3();
button_text(check1, "Enable 3&D Render");
button_text(check2, "Enable &Preview Settings");
button_state(check1, ekGUI_ON);
button_state(check2, ekGUI_MIXED);
layout_layout(layout, layout1, 0, 0);
layout_button(layout2, check1, 0, 0);
layout_layout(layout2, layout3, 0, 1);
layout_button(layout2, check2, 1, 0);
layout_layout(layout2, layout4, 1, 1);
layout_layout(layout, layout2, 0, 1);
layout_layout(layout, layout5, 0, 2);
layout_halign(layout, 0, 0, ekLEFT);
layout_margin(layout2, 5);
layout_hmargin(layout2, 0, 10);
layout_margin(layout5, 5);
return layout;
}

/*-----*/

Panel *buttons_basics(Button **defbutton)
{
    Layout *layout = i_buttons(defbutton);
    Panel *panel = panel_create();
    panel_layout(panel, layout);
    return panel;
}

```

27.4. Hello PopUp and Combo!



Figure 27.3: PopUp controls.

Listing 27.3: demo/guihello/popcom.c

```
/* PopUp and Combo */
```

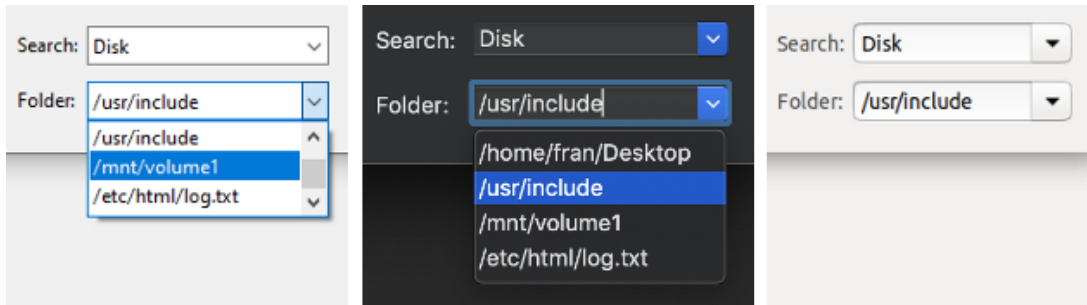

Figure 27.4: Combo controls.

```

#include "popcom.h"
#include "res_guihello.h"
#include <gui/guiall.h>

/*-----*/

static void i_popups(Layout *layout)
{
    Label *label1 = label_create();
    Label *label2 = label_create();
    PopUp *popup1 = popup_create();
    PopUp *popup2 = popup_create();
    label_text(label1, "Language:");
    label_text(label2, "Color:");
    popup_add_elem(popup1, "English", gui_image(UKING_PNG));
    popup_add_elem(popup1, "Español", gui_image(SPAIN_PNG));
    popup_add_elem(popup1, "Portugues", gui_image(PORTUGAL_PNG));
    popup_add_elem(popup1, "Italiana", gui_image(ITALY_PNG));
    popup_add_elem(popup1, "êTing êVit", gui_image(VIETNAM_PNG));
    popup_add_elem(popup1, "РоссиИ", gui_image(RUSSIA_PNG));
    popup_add_elem(popup1, "□□□", gui_image(JAPAN_PNG));
    popup_add_elem(popup2, "Red", gui_image(RED_PNG));
    popup_add_elem(popup2, "Blue", gui_image(BLUE_PNG));
    popup_add_elem(popup2, "Green", gui_image(GREEN_PNG));
    popup_add_elem(popup2, "Yellow", gui_image(YELLOW_PNG));
    popup_add_elem(popup2, "Black", gui_image(BLACK_PNG));
    popup_add_elem(popup2, "White", gui_image(WHITE_PNG));
    popup_list_height(popup1, 10);
    popup_list_height(popup2, 10);
    layout_label(layout, label1, 0, 0);
    layout_label(layout, label2, 0, 1);
    layout_popup(layout, popup1, 1, 0);
    layout_popup(layout, popup2, 1, 1);
}

/*-----*/

```

```

static void i_combos(Layout *layout)
{
    Label *label1 = label_create();
    Label *label2 = label_create();
    Combo *combo1 = combo_create();
    Combo *combo2 = combo_create();
    label_text(label1, "Search:");
    label_text(label2, "Folder:");
    combo_add_elem(combo1, "Search", NULL);
    combo_add_elem(combo1, "Disk", NULL);
    combo_add_elem(combo1, "Edit", NULL);
    combo_add_elem(combo2, "/home/fran/Desktop", NULL);
    combo_add_elem(combo2, "/usr/include", NULL);
    combo_add_elem(combo2, "/mnt/volume1", NULL);
    combo_add_elem(combo2, "/etc/html/log.txt", NULL);
    layout_label(layout, label1, 2, 0);
    layout_label(layout, label2, 2, 1);
    layout_combo(layout, combo1, 3, 0);
    layout_combo(layout, combo2, 3, 1);
}

/*-----*/

Panel *popup_combo(void)
{
    Panel *panel = panel_create();
    Layout *layout = layout_create(4, 2);
    i_popups(layout);
    i_combos(layout);
    layout_margin(layout, 10.f);
    layout_vmargin(layout, 0, 10.f);
    layout_hmargin(layout, 0, 5.f);
    layout_hmargin(layout, 1, 10.f);
    layout_hmargin(layout, 2, 5.f);
    layout_hsize(layout, 1, 150.f);
    layout_hsize(layout, 3, 150.f);
    panel_layout(panel, layout);
    return panel;
}

```

27.5. Hello Edit and UpDown!

Listing 27.4: demo/guihello/form.c

```

/* Form demo */

#include "form.h"
#include <gui/guiall.h>

/*-----*/

```

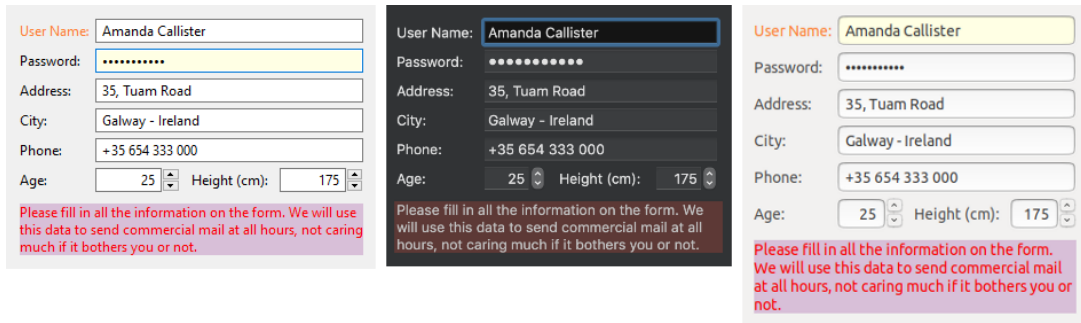



Figure 27.5: Edit and UpDown controls.

```

typedef struct _form_data_t FormData;

struct _form_data_t
{
    Window *window;
    Window *modal_window;
    Button *validate_check;
};

#define BUTTON_YES 1000
#define BUTTON_NO 1001

/*-----*/

static void i_destroy_data(FormData **data)
{
    cassert_no_null(data);
    cassert_no_null(*data);
    ptr_destopt(window_destroy, &(*data)->modal_window, Window);
    heap_delete(data, FormData);
}

/*-----*/

static void i_OnFilter(void *noused, Event *e)
{
    const EvText *params = event_params(e, EvText);
    EvTextFilter *result = event_result(e, EvTextFilter);
    uint32_t i = 0, j = 0;
    while (params->text[i] != '\0')
    {
        if (params->text[i] >= '0' && params->text[i] <= '9')
        {
            result->text[j] = params->text[i];
            j += 1;
        }
    }
}

```

```

        i += 1;
    }

    result->text[j] = '\\0';
    result->apply = TRUE;
    unref(noused);
}

/*-----*/

static void i_OnModalButton(FormData *data, Event *e)
{
    Button *button = event_sender(e, Button);
    uint32_t tag = button_get_tag(button);
    window_stop_modal(data->modal_window, tag);
}

/*-----*/

static Window *i_modal_window(FormData *data, Edit *edit, const GuiControl *
↪ next, const char_t *field_text, const char_t *action_text)
{
    Layout *layout1 = layout_create(1, 2);
    Layout *layout2 = layout_create(3, 1);
    Label *label = label_multiline();
    Button *button1 = button_push();
    Button *button2 = button_push();
    Panel *panel = panel_create();
    Window *window = window_create(ekWINDOW_STD | ekWINDOW_ESC);
    String *str = str_printf("Do you want to validate the text '%s' of the
↪ EditBox '%p'? The focus will be moved to the '%p' control using the
↪ '%s' action.", field_text, (void *)edit, (void *)next, action_text);
    label_text(label, tc(str));
    button_text(button1, "Yes");
    button_text(button2, "No");
    button_tag(button1, BUTTON_YES);
    button_tag(button2, BUTTON_NO);
    button_OnClick(button1, listener(data, i_OnModalButton, FormData));
    button_OnClick(button2, listener(data, i_OnModalButton, FormData));
    layout_label(layout1, label, 0, 0);
    layout_button(layout2, button1, 1, 0);
    layout_button(layout2, button2, 2, 0);
    layout_layout(layout1, layout2, 0, 1);
    layout_hsize(layout1, 0, 250);
    layout_vmargin(layout1, 0, 10);
    layout_hmargin(layout2, 1, 5);
    layout_margin4(layout2, 0, 10, 0, 0);
    layout_margin(layout1, 10);
    layout_hexpand(layout2, 0);
    window_title(window, "Data validation");
}

```

```

panel_layout(panel, layout1);
window_panel(window, panel);
window_defbutton(window, button1);
str_destroy(&str);
return window;
}

/*-----*/

static const char_t *i_action_text(const gui_tab_t action)
{
    switch (action)
    {
        case ekGUI_TAB_KEY:
            return "TAB_KEY";
        case ekGUI_TAB_BACKKEY:
            return "TAB_BACKKEY";
        case ekGUI_TAB_NEXT:
            return "TAB_NEXT";
        case ekGUI_TAB_PREV:
            return "TAB_PREV";
        case ekGUI_TAB_MOVE:
            return "TAB_MOVE";
        case ekGUI_TAB_CLICK:
            return "TAB_CLICK";
    }

    return "TAB_UNKNOWN";
}

/*-----*/

static V2Df i_modal_pos(Window *window, Window *parent)
{
    V2Df pos = window_get_origin(parent);
    S2Df s1 = window_get_size(parent);
    S2Df s2 = window_get_size(window);
    real32_t x = pos.x + ((s1.width - s2.width) / 2);
    real32_t y = pos.y + ((s1.height - s2.height) / 2);
    return v2df(x, y);
}

/*-----*/

static bool_t i_validate_field(FormData *data, Edit *edit, const char_t *text)
{
    FocusInfo info;
    const char_t *action_text = NULL;
    uint32_t modal_value = UINT32_MAX;
    V2Df pos;
    cassert_no_null(data);

```

```

cassert(data->modal_window == NULL);
window_focus_info(data->window, &info);
action_text = i_action_text(info.action);
data->modal_window = i_modal_window(data, edit, info.next, text,
    ↪ action_text);
pos = i_modal_pos(data->modal_window, data->window);
window_origin(data->modal_window, pos);
modal_value = window_modal(data->modal_window, data->window);
window_destroy(&data->modal_window);
switch (modal_value)
{
case ekGUI_CLOSE_BUTTON:
case ekGUI_CLOSE_ESC:
case BUTTON_NO:
    return FALSE;
case BUTTON_YES:
    return TRUE;
    cassert_default();
}

return TRUE;
}

/*-----*/

static void i_OnEditChange(FormData *data, Event *e)
{
    const EvText *p = event_params(e, EvText);
    Edit *edit = event_sender(e, Edit);
    cassert_no_null(data);
    if (button_get_state(data->validate_check) == ekGUI_ON)
    {
        bool_t *r = event_result(e, bool_t);
        *r = i_validate_field(data, edit, p->text);
    }
}

/*-----*/

static void i_OnUpDown(Edit *edit, Event *e)
{
    const EvButton *params = event_params(e, EvButton);
    int32_t n = str_to_i32(edit_get_text(edit), 10, NULL);
    char_t text[64];
    n += (params->index == 0) ? 1 : -1;
    bstd_sprintf(text, sizeof(text), "%d", n);
    edit_text(edit, text);
}

/*-----*/

```

```

static Layout *i_numbers(FormData *data, color_t colorbg)
{
    Layout *layout = layout_create(5, 1);
    Label *label = label_create();
    Edit *edit1 = edit_create();
    Edit *edit2 = edit_create();
    UpDown *updown1 = updown_create();
    UpDown *updown2 = updown_create();
    label_text(label, "Height (cm):");
    edit_text(edit1, "25");
    edit_text(edit2, "175");
    edit_autoselect(edit1, TRUE);
    edit_align(edit1, ekRIGHT);
    edit_align(edit2, ekRIGHT);
    edit_OnFilter(edit1, listener(NULL, i_OnFilter, void));
    edit_OnFilter(edit2, listener(NULL, i_OnFilter, void));
    edit_OnChange(edit1, listener(data, i_OnEditChange, FormData));
    edit_OnChange(edit2, listener(data, i_OnEditChange, FormData));
    edit_bgcolor_focus(edit1, colorbg);
    edit_bgcolor_focus(edit2, colorbg);
    updown_OnClick(updown1, listener(edit1, i_OnUpDown, Edit));
    updown_OnClick(updown2, listener(edit2, i_OnUpDown, Edit));
    updown_tooltip(updown1, "Increase/Decrease age");
    updown_tooltip(updown2, "Increase/Decrease height");
    layout_label(layout, label, 2, 0);
    layout_edit(layout, edit1, 0, 0);
    layout_edit(layout, edit2, 3, 0);
    layout_updown(layout, updown1, 1, 0);
    layout_updown(layout, updown2, 4, 0);
    layout_hmargin(layout, 1, 10.f);
    layout_hmargin(layout, 2, 10.f);
    layout_hexpand2(layout, 0, 3, .5f);
    return layout;
}

/*-----*/

static Layout *i_edits(FormData *data)
{
    color_t colorbg = gui_alt_color(color_bgr(0xFFFFe4), color_bgr(0x101010));
    Layout *layout1 = layout_create(2, 6);
    Layout *layout2 = i_numbers(data, colorbg);
    Label *label1 = label_create();
    Label *label2 = label_create();
    Label *label3 = label_create();
    Label *label4 = label_create();
    Label *label5 = label_create();
    Label *label6 = label_create();
    Edit *edit1 = edit_create();
    Edit *edit2 = edit_create();
    Edit *edit3 = edit_create();
}

```

```

Edit *edit4 = edit_create();
Edit *edit5 = edit_create();
label_text(label1, "User Name:");
label_text(label2, "Password:");
label_text(label3, "Address:");
label_text(label4, "City:");
label_text(label5, "Phone:");
label_text(label6, "Age:");
label_color_over(label1, color_rgb(255, 128, 52));
label_color_over(label2, color_rgb(70, 129, 207));
label_color_over(label3, color_rgb(119, 188, 31));
label_style_over(label4, ekFITALIC | ekFUNDERLINE);
edit_text(edit1, "Amanda Callister");
edit_text(edit2, "aQwe56nhjJk");
edit_text(edit3, "35, Tuam Road");
edit_text(edit4, "Galway - Ireland");
edit_text(edit5, "+35 654 333 000");
edit_OnChange(edit1, listener(data, i_OnEditChange, FormData));
edit_OnChange(edit2, listener(data, i_OnEditChange, FormData));
edit_OnChange(edit3, listener(data, i_OnEditChange, FormData));
edit_OnChange(edit4, listener(data, i_OnEditChange, FormData));
edit_OnChange(edit5, listener(data, i_OnEditChange, FormData));
edit_select(edit1, 2, 6);
edit_passmode(edit2, TRUE);
edit_bgcolor_focus(edit1, colorbg);
edit_bgcolor_focus(edit2, colorbg);
edit_bgcolor_focus(edit3, colorbg);
edit_bgcolor_focus(edit4, colorbg);
edit_bgcolor_focus(edit5, colorbg);
layout_label(layout1, label1, 0, 0);
layout_label(layout1, label2, 0, 1);
layout_label(layout1, label3, 0, 2);
layout_label(layout1, label4, 0, 3);
layout_label(layout1, label5, 0, 4);
layout_label(layout1, label6, 0, 5);
layout_edit(layout1, edit1, 1, 0);
layout_edit(layout1, edit2, 1, 1);
layout_edit(layout1, edit3, 1, 2);
layout_edit(layout1, edit4, 1, 3);
layout_edit(layout1, edit5, 1, 4);
layout_layout(layout1, layout2, 1, 5);
layout_hmargin(layout1, 0, 5);
layout_hexpand(layout1, 1);
layout_vmargin(layout1, 0, 5);
layout_vmargin(layout1, 1, 5);
layout_vmargin(layout1, 2, 5);
layout_vmargin(layout1, 3, 5);
layout_vmargin(layout1, 4, 5);
return layout1;
}

```

```

/*-----*/

static Layout *i_toolbar(FormData *data)
{
    Layout *layout = layout_create(1, 1);
    Button *check = button_check();
    button_text(check, "Field validations");
    layout_button(layout, check, 0, 0);
    data->validate_check = check;
    return layout;
}

/*-----*/

static Layout *i_form(FormData *data)
{
    Layout *layout1 = layout_create(1, 3);
    Layout *layout2 = i_edits(data);
    Layout *layout3 = i_toolbar(data);
    Label *label = label_multiline();
    cassert_no_null(data);
    label_text(label, "Please fill in all the information on the form. We will
        ↪ use this data to send commercial mail at all hours, not caring much
        ↪ if it bothers you or not.");
    label_color(label, gui_alt_color(color_rgb(255, 0, 0), color_rgb(180, 180,
        ↪ 180)));
    label_bgcolor(label, gui_alt_color(color_rgb(216, 191, 216), color_rgb(80,
        ↪ 40, 40)));
    label_bgcolor_over(label, gui_alt_color(color_rgb(255, 250, 205), color_rgb
        ↪ (105, 100, 55)));
    label_style_over(label, ekFUNDERLINE);
    layout_layout(layout1, layout2, 0, 0);
    layout_layout(layout1, layout3, 0, 1);
    layout_label(layout1, label, 0, 2);
    layout_hsize(layout1, 0, 300);
    layout_halign(layout1, 0, 1, ekLEFT);
    layout_vmargn(layout1, 0, 10);
    layout_vmargn(layout1, 1, 10);
    layout_margin(layout1, 10);
    layout_tabstop(layout1, 0, 1, FALSE);
    return layout1;
}

/*-----*/

static FormData *i_form_data(Window *window)
{
    FormData *data = heap_new0(FormData);
    data->window = window;
    return data;
}

```

```

/*-----*/

Panel *form_basic(Window *window)
{
    FormData *data = i_form_data(window);
    Layout *layout = i_form(data);
    Panel *panel = panel_create();
    panel_data(panel, &data, i_destroy_data, FormData);
    panel_layout(panel, layout);
    return panel;
}

```

27.6. Hello TextSel and Clipboard!

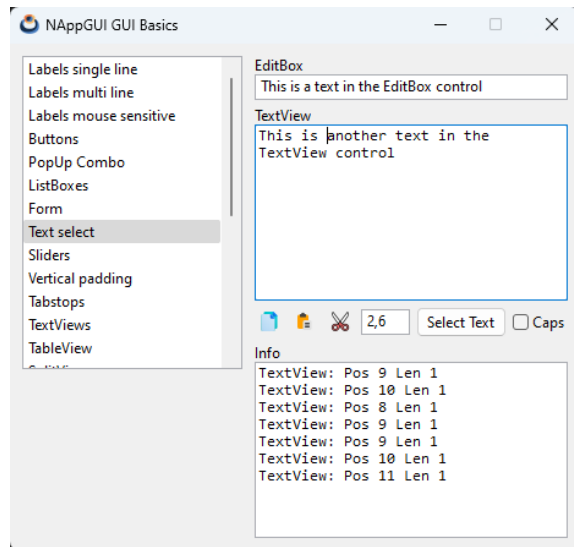

Figure 27.6: Text selection and operations on the clipboard.

Listing 27.5: demo/guihello/seltext.c

```

/* Text selection and clipboard demo */

#include "seltext.h"
#include "res_guihello.h"
#include <gui/guia11.h>

/*-----*/

typedef struct _sel_data_t SelData;

struct _sel_data_t
{
    Window *window;

```



```

    Edit *edit;
    Edit *edit_range;
    Button *caps;
    TextView *text;
    TextView *info_text;
};

/*-----*/

static void i_destroy_data(SelData **data)
{
    heap_delete(data, SelData);
}

/*-----*/

static void i_OnCopy(SelData *data, Event *e)
{
    GuiControl *control = NULL;
    cassert_no_null(data);
    unref(e);
    control = window_get_focus(data->window);
    if (guicontrol_edit(control) == data->edit)
        edit_copy(data->edit);
    else if (guicontrol_textview(control) == data->text)
        textview_copy(data->text);
}

/*-----*/

static void i_OnPaste(SelData *data, Event *e)
{
    GuiControl *control = NULL;
    cassert_no_null(data);
    unref(e);
    control = window_get_focus(data->window);
    if (guicontrol_edit(control) == data->edit)
        edit_paste(data->edit);
    else if (guicontrol_textview(control) == data->text)
        textview_paste(data->text);
}

/*-----*/

static void i_OnCut(SelData *data, Event *e)
{
    GuiControl *control = NULL;
    cassert_no_null(data);
    unref(e);
    control = window_get_focus(data->window);
    if (guicontrol_edit(control) == data->edit)

```

```

        edit_cut(data->edit);
    else if (guicontrol_textview(control) == data->text)
        textview_cut(data->text);
}

/*-----*/

static void i_OnSelect(SelData *data, Event *e)
{
    GuiControl *control = NULL;
    const char_t *range = NULL;
    String *left = NULL, *right = NULL;
    int32_t start = 0, end = 0;
    cassert_no_null(data);
    unref(e);
    control = window_get_focus(data->window);
    range = edit_get_text(data->edit_range);
    str_split_trim(range, ",", &left, &right);
    start = str_to_i32(tc(left), 10, NULL);
    end = str_to_i32(tc(right), 10, NULL);

    if (guicontrol_edit(control) == data->edit)
        edit_select(data->edit, start, end);
    else if (guicontrol_textview(control) == data->text)
        textview_select(data->text, start, end);

    str_destroy(&left);
    str_destroy(&right);
}

/*-----*/

static void i_OnWrap(SelData *data, Event *e)
{
    const EvButton *p = event_params(e, EvButton);
    cassert_no_null(data);
    textview_wrap(data->text, p->state == ekGUI_ON ? TRUE : FALSE);
}

/*-----*/

static void i_OnEditFilter(SelData *data, Event *e)
{
    const EvText *p = event_params(e, EvText);
    cassert_no_null(data);

    /*
     * Convert the inserted text in caps.
     * p->text the control current text (const).
     * r->text the new filtered text.
     * p->cpos current caret position.
    */
}

```

```

* r->apply = TRUE means the editbox text has to be updated.
* p->len number of chars inserted at left of caret (to caps).
* We are working with UTF8-Strings. Sequential access.
*/
if (button_get_state(data->caps) == ekGUI_ON && p->len > 0)
{
    EvTextFilter *r = event_result(e, EvTextFilter);
    const char_t *src = p->text;
    char_t *dest = r->text;
    uint32_t cp = unicode_to_u32(src, ekUTF8);
    uint32_t pos = 0;
    while (cp != 0)
    {
        uint32_t offset = 0;
        if (pos >= p->cpos - p->len && pos < p->cpos)
        {
            if (cp >= 'a' && cp <= 'z')
                cp -= 32;
        }
        offset = unicode_to_char(cp, dest, ekUTF8);
        dest += offset;
        src = unicode_next(src, ekUTF8);
        cp = unicode_to_u32(src, ekUTF8);
        pos += 1;
    }

    *dest = 0;
    r->cpos = p->cpos;
    r->apply = TRUE;
}

textview_printf(data->info_text, "Edit: Pos %d Len %d\n", p->cpos, p->len);
textview_scroll_caret(data->info_text);
}

/*-----*/

static void i_OnTextViewFilter(SelData *data, Event *e)
{
    const EvText *p = event_params(e, EvText);
    cassert_no_null(data);

    /*
    * Convert the inserted text in caps.
    * p->text the inserted text only (const).
    * r->text the new filtered text.
    * p->cpos current caret position.
    * r->apply = TRUE means the editbox text has to be updated.
    * p->len number of chars inserted at left of caret (to caps).
    * We are working with UTF8-Strings. Sequential access.
    */
}

```

```

if (button_get_state(data->caps) == ekGUI_ON && p->len > 0)
{
    EvTextFilter *r = event_result(e, EvTextFilter);
    const char_t *src = p->text;
    char_t *dest = r->text;
    uint32_t cp = unicode_to_u32(src, ekUTF8);
    uint32_t pos = 0;
    while (cp != 0)
    {
        uint32_t offset = 0;

        if (cp >= 'a' && cp <= 'z')
            cp -= 32;

        offset = unicode_to_char(cp, dest, ekUTF8);
        dest += offset;
        src = unicode_next(src, ekUTF8);
        cp = unicode_to_u32(src, ekUTF8);
        pos += 1;
    }

    *dest = 0;
    r->cpos = p->cpos;
    r->apply = TRUE;
}

textview_printf(data->info_text, "TextView: Pos %d Len %d\n", p->cpos, p->
↪ len);
textview_scroll_caret(data->info_text);
}

/*-----*/

static Layout *i_text_controls(SelData *data)
{
    Layout *layout = layout_create(7, 1);
    Button *button1 = button_flat();
    Button *button2 = button_flat();
    Button *button3 = button_flat();
    Button *button4 = button_push();
    Button *button5 = button_check();
    Button *button6 = button_check();
    Edit *edit = edit_create();
    button_image(button1, gui_image(COPY_PNG));
    button_image(button2, gui_image(PASTE_PNG));
    button_image(button3, gui_image(CUT_PNG));
    edit_text(edit, "2,6");
    button_OnClick(button1, listener(data, i_OnCopy, SelData));
    button_OnClick(button2, listener(data, i_OnPaste, SelData));
    button_OnClick(button3, listener(data, i_OnCut, SelData));
    button_tooltip(button1, "Copy");
}

```

```

    button_tooltip(button2, "Paste");
    button_tooltip(button3, "Cut");
    button_text(button4, "Select Text");
    button_text(button5, "Caps");
    button_text(button6, "Wrap");
    button_OnClick(button4, listener(data, i_OnSelect, SelData));
    button_OnClick(button6, listener(data, i_OnWrap, SelData));
    button_state(button6, ekGUI_ON);
    layout_button(layout, button1, 0, 0);
    layout_button(layout, button2, 1, 0);
    layout_button(layout, button3, 2, 0);
    layout_edit(layout, edit, 3, 0);
    layout_button(layout, button4, 4, 0);
    layout_button(layout, button5, 5, 0);
    layout_button(layout, button6, 6, 0);
    layout_hsize(layout, 3, 40);
    layout_hmargin(layout, 0, 5);
    layout_hmargin(layout, 1, 5);
    layout_hmargin(layout, 2, 5);
    layout_hmargin(layout, 3, 5);
    layout_hmargin(layout, 4, 5);
    layout_hmargin(layout, 5, 5);
    data->edit_range = edit;
    data->caps = button5;
    return layout;
}

/*-----*/

static Layout *i_layout(SelData *data)
{
    Layout *layout1 = layout_create(1, 7);
    Layout *layout2 = i_text_controls(data);
    Label *label1 = label_create();
    Label *label2 = label_create();
    Label *label3 = label_create();
    Edit *edit = edit_create();
    TextView *text1 = textview_create();
    TextView *text2 = textview_create();
    cassert_no_null(data);
    label_text(label1, "EditBox");
    label_text(label2, "TextView");
    label_text(label3, "Info");
    edit_text(edit, "This is a text in the EditBox control");
    edit_OnFilter(edit, listener(data, i_OnEditFilter, SelData));
    textview_writeln(text1, "This is another text in the TextView control, wider
        ↪ than the control.");
    textview_editable(text1, TRUE);
    textview_OnFilter(text1, listener(data, i_OnTextViewFilter, SelData));
    layout_label(layout1, label1, 0, 0);
    layout_edit(layout1, edit, 0, 1);
}

```

```

    layout_label(layout1, label2, 0, 2);
    layout_textview(layout1, text1, 0, 3);
    layout_layout(layout1, layout2, 0, 4);
    layout_label(layout1, label3, 0, 5);
    layout_textview(layout1, text2, 0, 6);
    layout_tabstop(layout1, 0, 3, TRUE);
    layout_tabstop(layout1, 0, 4, FALSE);
    layout_halign(layout1, 0, 4, ekLEFT);
    layout_vmargin(layout1, 1, 5);
    layout_vmargin(layout1, 3, 5);
    layout_vmargin(layout1, 4, 5);
    data->edit = edit;
    data->text = text1;
    data->info_text = text2;
    return layout1;
}

/*-----*/

static SelData *i_seldata(Window *window)
{
    SelData *data = heap_new0(SelData);
    data->window = window;
    return data;
}

/*-----*/

Panel *seltext(Window *window)
{
    SelData *data = i_seldata(window);
    Layout *layout = i_layout(data);
    Panel *panel = panel_create();
    panel_data(panel, &data, i_destroy_data, SelData);
    panel_layout(panel, layout);
    return panel;
}

```

27.7. Hello TextEditor!

Listing 27.6: demo/guihello/editor.c

```

/* Text editor demo */

#include "editor.h"
#include "res_guihello.h"
#include <gui/guiall.h>

/*-----*/

```

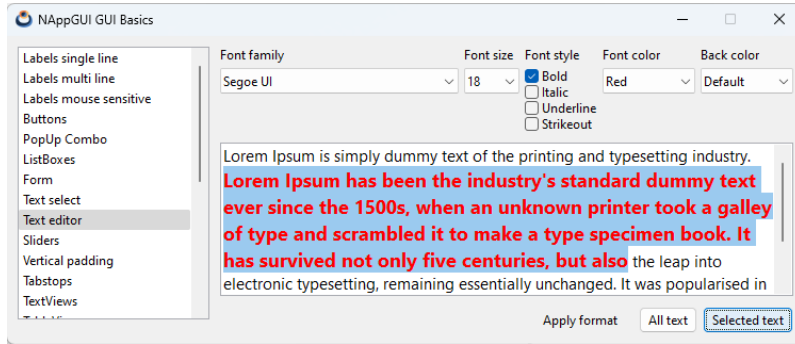

Figure 27.7: Text editing functions.

```

typedef struct _edit_data_t EditData;

struct _edit_data_t
{
    ArrPt(String) *fonts;
    Window *window;
    TextView *text;
    PopUp *family_popup;
    PopUp *size_popup;
    PopUp *color_popup;
    PopUp *back_popup;
    Button *bold_check;
    Button *italic_check;
    Button *under_check;
    Button *strike_check;
};

/*-----*/

static color_t i_COLORS[9];

/*-----*/

static void i_destroy_data(EditData **data)
{
    cassert_no_null(data);
    cassert_no_null(*data);
    arrpt_destroy(&(*data)->fonts, str_destroy, String);
    heap_delete(data, EditData);
}

/*-----*/

static void i_apply_params(EditData *data, const bool_t apply_all)
{
    const char_t *ffamily = NULL;

```

```

const char_t *tsize = NULL;
real32_t fsize = 0;
uint32_t fstyle = 0;
color_t color = 0;
color_t back = 0;
cassert_no_null(data);

/* Get text attribs from GUI controls */
ffamily = popup_get_text(data->family_popup, popup_get_selected(data->
    ↪ family_popup));
tsize = popup_get_text(data->size_popup, popup_get_selected(data->
    ↪ size_popup));
fsize = str_to_r32(tsize, NULL);

if (button_get_state(data->bold_check) == ekGUI_ON)
    fstyle |= ekFBOLD;
if (button_get_state(data->italic_check) == ekGUI_ON)
    fstyle |= ekFITALIC;
if (button_get_state(data->under_check) == ekGUI_ON)
    fstyle |= ekFUNDERLINE;
if (button_get_state(data->strike_check) == ekGUI_ON)
    fstyle |= ekFSTRIKEOUT;

color = i_COLORS[popup_get_selected(data->color_popup)];
back = i_COLORS[popup_get_selected(data->back_popup)];

/* Set textview params */
textview_family(data->text, ffamily);
textview_fsize(data->text, fsize);
textview_fstyle(data->text, fstyle);
textview_color(data->text, color);
textview_bgcolor(data->text, back);

/* Apply the format */
if (apply_all == TRUE)
    textview_apply_all(data->text);
else
    textview_apply_sel(data->text);
}

/*-----*/

static PopUp *i_font_popup(EditData *data)
{
    PopUp *popup = popup_create();
    Font *sfont = font_system(15, 0);
    const char_t *fname = font_family(sfont);
    uint32_t sel = UINT32_MAX;
    uint32_t arial = UINT32_MAX;
    cassert_no_null(data);
    data->fonts = font_installed_families();
}

```



```

arrpt_foreach_const(font, data->font, String)
    popup_add_elem(popup, tc(font), NULL);
    if (str_equ(font, fname) == TRUE)
        sel = font_i;
    if (str_equ_nocase(tc(font), "Arial") == TRUE)
        arial = font_i;
arrpt_end()

if (sel != UINT32_MAX)
    popup_selected(popup, sel);
else if (arial != UINT32_MAX)
    popup_selected(popup, arial);
else
    popup_selected(popup, 0);

popup_list_height(popup, 20);
font_destroy(&sfont);
return popup;
}

/*-----*/

static PopUp *i_font_size(void)
{
    PopUp *popup = popup_create();
    uint32_t i = 0;
    for (i = 10; i <= 30; ++i)
    {
        char_t buf[32];
        bstd_sprintf(buf, sizeof(buf), "%d", i);
        popup_add_elem(popup, buf, NULL);
    }
    return popup;
}

/*-----*/

static PopUp *i_font_color(void)
{
    PopUp *popup = popup_create();
    popup_add_elem(popup, "Default", NULL);
    popup_add_elem(popup, "Black", NULL);
    popup_add_elem(popup, "White", NULL);
    popup_add_elem(popup, "Red", NULL);
    popup_add_elem(popup, "Green", NULL);
    popup_add_elem(popup, "Blue", NULL);
    popup_add_elem(popup, "Yellow", NULL);
    popup_add_elem(popup, "Cyan", NULL);
    popup_add_elem(popup, "Magenta", NULL);
    return popup;
}

```

```

}

/*-----*/

static Layout *i_font_style(EditData *data)
{
    Layout *layout = layout_create(1, 4);
    Button *button1 = button_check();
    Button *button2 = button_check();
    Button *button3 = button_check();
    Button *button4 = button_check();
    cassert_no_null(data);
    button_text(button1, "Bold");
    button_text(button2, "Italic");
    button_text(button3, "Underline");
    button_text(button4, "Strikeout");
    layout_button(layout, button1, 0, 0);
    layout_button(layout, button2, 0, 1);
    layout_button(layout, button3, 0, 2);
    layout_button(layout, button4, 0, 3);
    data->bold_check = button1;
    data->italic_check = button2;
    data->under_check = button3;
    data->strike_check = button4;
    return layout;
}

/*-----*/

static Layout *i_text_controls(EditData *data)
{
    Layout *layout1 = layout_create(5, 2);
    Layout *layout2 = i_font_style(data);
    Label *label1 = label_create();
    Label *label2 = label_create();
    Label *label3 = label_create();
    Label *label4 = label_create();
    Label *label5 = label_create();
    PopUp *popup1 = i_font_popup(data);
    PopUp *popup2 = i_font_size();
    PopUp *popup3 = i_font_color();
    PopUp *popup4 = i_font_color();
    label_text(label1, "Font family");
    label_text(label2, "Font size");
    label_text(label3, "Font style");
    label_text(label4, "Font color");
    label_text(label5, "Back color");
    popup_selected(popup2, 5);
    layout_label(layout1, label1, 0, 0);
    layout_label(layout1, label2, 1, 0);
    layout_label(layout1, label3, 2, 0);
}

```

```

    layout_label(layout1, label4, 3, 0);
    layout_label(layout1, label5, 4, 0);
    layout_popup(layout1, popup1, 0, 1);
    layout_popup(layout1, popup2, 1, 1);
    layout_layout(layout1, layout2, 2, 1);
    layout_popup(layout1, popup3, 3, 1);
    layout_popup(layout1, popup4, 4, 1);
    layout_hmargin(layout1, 0, 5);
    layout_hmargin(layout1, 1, 5);
    layout_hmargin(layout1, 2, 5);
    layout_hmargin(layout1, 3, 5);
    layout_vmargin(layout1, 0, 5);
    layout_valign(layout1, 0, 1, ekTOP);
    layout_valign(layout1, 1, 1, ekTOP);
    layout_valign(layout1, 2, 1, ekTOP);
    layout_valign(layout1, 3, 1, ekTOP);
    layout_valign(layout1, 4, 1, ekTOP);
    data->family_popup = popup1;
    data->size_popup = popup2;
    data->color_popup = popup3;
    data->back_popup = popup4;
    return layout1;
}

/*-----*/

static void i_OnApplyAll(EditData *data, Event *e)
{
    i_apply_params(data, TRUE);
    unref(e);
}

/*-----*/

static void i_OnApplySel(EditData *data, Event *e)
{
    i_apply_params(data, FALSE);
    unref(e);
}

/*-----*/

static Layout *i_apply_buttons(EditData *data)
{
    Layout *layout = layout_create(3, 1);
    Label *label = label_create();
    Button *button1 = button_push();
    Button *button2 = button_push();
    label_text(label, "Apply format");
    button_text(button1, "All text");
    button_text(button2, "Selected text");
}

```

```

    button_OnClick(button1, listener(data, i_OnApplyAll, EditData));
    button_OnClick(button2, listener(data, i_OnApplySel, EditData));
    layout_label(layout, label, 0, 0);
    layout_button(layout, button1, 1, 0);
    layout_button(layout, button2, 2, 0);
    layout_hmargin(layout, 0, 20);
    layout_hmargin(layout, 1, 5);
    return layout;
}

/*-----*/

static Layout *i_layout(EditData *data)
{
    Layout *layout1 = layout_create(1, 3);
    Layout *layout2 = i_text_controls(data);
    Layout *layout3 = i_apply_buttons(data);
    TextView *text = textview_create();
    cassert_no_null(data);
    textview_editable(text, TRUE);
    textview_show_select(text, TRUE);
    layout_layout(layout1, layout2, 0, 0);
    layout_textview(layout1, text, 0, 1);
    layout_layout(layout1, layout3, 0, 2);
    layout_halign(layout1, 0, 2, ekRIGHT);
    layout_vmargin(layout1, 0, 10);
    layout_vmargin(layout1, 1, 10);
    layout_tabstop(layout1, 0, 1, TRUE);
    data->text = text;
    return layout1;
}

/*-----*/

static EditData *i_edit_data(Window *window)
{
    EditData *data = heap_new0(EditData);
    data->>window = window;
    return data;
}

/*-----*/

static void i_colors(void)
{
    i_COLORS[0] = kCOLOR_DEFAULT;
    i_COLORS[1] = kCOLOR_BLACK;
    i_COLORS[2] = kCOLOR_WHITE;
    i_COLORS[3] = kCOLOR_RED;
    i_COLORS[4] = kCOLOR_GREEN;
    i_COLORS[5] = kCOLOR_BLUE;
}

```

```

    i_COLORS[6] = kCOLOR_YELLOW;
    i_COLORS[7] = kCOLOR_CYAN;
    i_COLORS[8] = kCOLOR_MAGENTA;
}

/*-----*/

Panel *editor(Window *window)
{
    EditData *data = i_edit_data(window);
    Layout *layout = i_layout(data);
    Panel *panel = panel_create();
    i_colors();
    i_apply_params(data, TRUE);
    panel_data(panel, &data, i_destroy_data, EditData);
    panel_layout(panel, layout);
    return panel;
}

```

27.8. Hello ListBox!

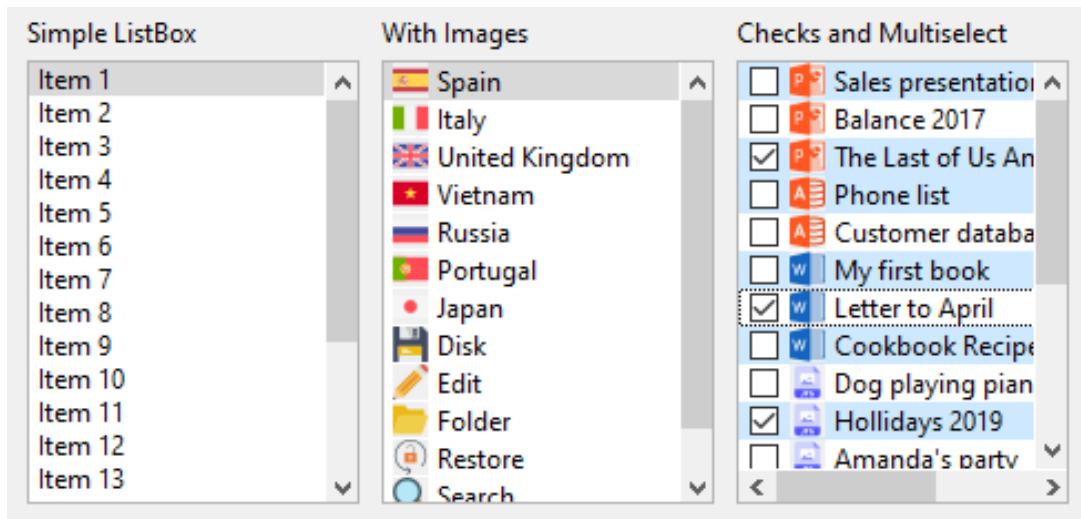

Figure 27.8: ListBox controls.

Listing 27.7: demo/guihello/listboxes.c

```

/* Listboxes */

#include "listboxes.h"
#include "res_guihello.h"
#include <gui/guiall.h>

```

```

/*-----*/

static ListBox *i_full_listbox(void)
{
    ListBox *listbox = listbox_create();
    listbox_size(listbox, s2df(150, 200));
    listbox_multisel(listbox, TRUE);
    listbox_checkbox(listbox, TRUE);
    listbox_add_elem(listbox, "Sales presentation", gui_image(POWERPOINT_PNG));
    listbox_add_elem(listbox, "Balance 2017", gui_image(POWERPOINT_PNG));
    listbox_add_elem(listbox, "The Last of Us Analysis", gui_image(
        ↪ POWERPOINT_PNG));
    listbox_add_elem(listbox, "Phone list", gui_image(ACCESS_PNG));
    listbox_add_elem(listbox, "Customer database", gui_image(ACCESS_PNG));
    listbox_add_elem(listbox, "My first book", gui_image(WORD_PNG));
    listbox_add_elem(listbox, "Letter to April", gui_image(WORD_PNG));
    listbox_add_elem(listbox, "Cookbook Recipes", gui_image(WORD_PNG));
    listbox_add_elem(listbox, "Dog playing piano", gui_image(JPG_PNG));
    listbox_add_elem(listbox, "Hollidays 2019", gui_image(JPG_PNG));
    listbox_add_elem(listbox, "Amanda's party", gui_image(JPG_PNG));
    listbox_add_elem(listbox, "Flying", gui_image(JPG_PNG));
    listbox_add_elem(listbox, "The C Programing Language", gui_image(PDF_PNG));
    listbox_add_elem(listbox, "Graphics Programing with GDI+", gui_image(
        ↪ PDF_PNG));
    listbox_add_elem(listbox, "Personal finances", gui_image(EXCEL_PNG));
    listbox_add_elem(listbox, "Stocks 2017", gui_image(EXCEL_PNG));
    listbox_add_elem(listbox, "Website Dashboard", gui_image(EXCEL_PNG));
    listbox_add_elem(listbox, "Open Issues", gui_image(DOCUMENT_PNG));
    listbox_add_elem(listbox, "TODO List", gui_image(DOCUMENT_PNG));
    listbox_select(listbox, 0, TRUE);
    return listbox;
}

/*-----*/

static ListBox *i_image_listbox(void)
{
    ListBox *listbox = listbox_create();
    listbox_size(listbox, s2df(150, 200));
    listbox_add_elem(listbox, "Spain", gui_image(SPAIN_PNG));
    listbox_add_elem(listbox, "Italy", gui_image(ITALY_PNG));
    listbox_add_elem(listbox, "United Kingdom", gui_image(UKING_PNG));
    listbox_add_elem(listbox, "Vietnam", gui_image(VIETNAM_PNG));
    listbox_add_elem(listbox, "Russia", gui_image(RUSSIA_PNG));
    listbox_add_elem(listbox, "Portugal", gui_image(PORTUGAL_PNG));
    listbox_add_elem(listbox, "Japan", gui_image(JAPAN_PNG));
    listbox_add_elem(listbox, "Disk", gui_image(DISK16_PNG));
    listbox_add_elem(listbox, "Edit", gui_image(EDIT16_PNG));
    listbox_add_elem(listbox, "Folder", gui_image(FOLDER16_PNG));
    listbox_add_elem(listbox, "Restore", gui_image(RESTORE16_PNG));
    listbox_add_elem(listbox, "Search", gui_image(SEARCH16_PNG));
}

```

```

listbox_add_elem(listbox, "Error", gui_image(ERROR16_PNG));
listbox_select(listbox, 0, TRUE);
return listbox;
}

/*-----*/

static ListBox *i_simple_listbox(void)
{
    ListBox *listbox = listbox_create();
    listbox_size(listbox, s2df(150, 200));
    listbox_add_elem(listbox, "Item 1", NULL);
    listbox_add_elem(listbox, "Item 2", NULL);
    listbox_add_elem(listbox, "Item 3", NULL);
    listbox_add_elem(listbox, "Item 4", NULL);
    listbox_color(listbox, 0, gui_alt_color(color_rgb(128, 0, 0), kCOLOR_RED));
    listbox_color(listbox, 1, gui_alt_color(color_rgb(0, 128, 0), kCOLOR_GREEN)
        ↪ );
    listbox_color(listbox, 2, gui_alt_color(color_rgb(0, 0, 128), kCOLOR_BLUE)
        ↪ );
    listbox_select(listbox, 0, TRUE);
    return listbox;
}

/*-----*/

Panel *listboxes(void)
{
    Panel *panel = panel_create();
    Layout *layout = layout_create(3, 2);
    Label *label1 = label_create();
    Label *label2 = label_create();
    Label *label3 = label_create();
    ListBox *listbox1 = i_simple_listbox();
    ListBox *listbox2 = i_image_listbox();
    ListBox *listbox3 = i_full_listbox();
    label_text(label1, "Simple ListBox");
    label_text(label2, "With Images");
    label_text(label3, "Checks and Multiselect");
    layout_label(layout, label1, 0, 0);
    layout_label(layout, label2, 1, 0);
    layout_label(layout, label3, 2, 0);
    layout_listbox(layout, listbox1, 0, 1);
    layout_listbox(layout, listbox2, 1, 1);
    layout_listbox(layout, listbox3, 2, 1);
    layout_hmargin(layout, 0, 10);
    layout_hmargin(layout, 1, 10);
    layout_vmargin(layout, 0, 5);
    panel_layout(panel, layout);
    return panel;
}

```

27.9. Hello Slider and Progress!

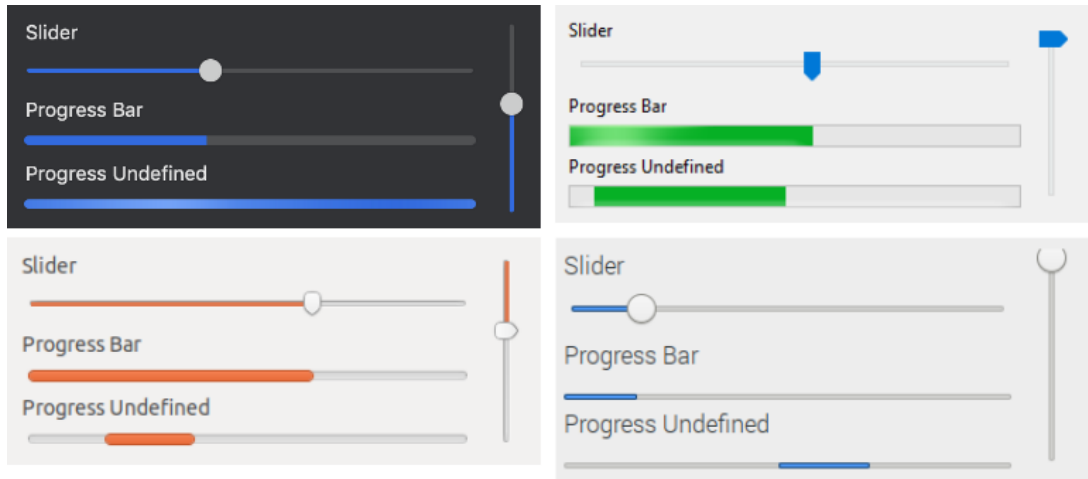

Figure 27.9: Slider and Progress controls.

Listing 27.8: demo/guihello/sliders.c

```

/* Sliders */

#include "sliders.h"
#include <gui/guiall.h>

/*-----*/

static void i_OnSlider(Progress *prog, Event *event)
{
    const EvSlider *params = event_params(event, EvSlider);
    progress_value(prog, params->pos);
}

/*-----*/

Panel *sliders(void)
{
    Layout *layout1 = layout_create(2, 1);
    Layout *layout2 = layout_create(1, 8);
    Label *label1 = label_create();
    Label *label2 = label_create();
    Label *label3 = label_create();
    Label *label4 = label_create();
    Slider *slider1 = slider_create();
    Slider *slider2 = slider_create();
    Slider *slider3 = slider_vertical();
    Progress *prog1 = progress_create();
    Progress *prog2 = progress_create();

```



```

Panel *panel = panel_create();
label_text(label1, "Slider");
label_text(label2, "Slider (discrete 6 steps)");
label_text(label3, "Progress Bar");
label_text(label4, "Progress Undefined");
slider_steps(slider2, 6);
slider_tooltip(slider1, "Horizontal Slider");
slider_tooltip(slider2, "Horizontal Discrete Slider");
slider_tooltip(slider3, "Vertical Slider");
slider_OnMoved(slider1, listener(prog1, i_OnSlider, Progress));
progress_undefined(prog2, TRUE);
layout_label(layout2, label1, 0, 0);
layout_label(layout2, label2, 0, 2);
layout_label(layout2, label3, 0, 4);
layout_label(layout2, label4, 0, 6);
layout_slider(layout2, slider1, 0, 1);
layout_slider(layout2, slider2, 0, 3);
layout_slider(layout1, slider3, 1, 0);
layout_progress(layout2, prog1, 0, 5);
layout_progress(layout2, prog2, 0, 7);
layout_hsize(layout2, 0, 300);
layout_layout(layout1, layout2, 0, 0);
layout_vmargin(layout2, 0, 5);
layout_vmargin(layout2, 1, 5);
layout_vmargin(layout2, 2, 5);
layout_vmargin(layout2, 3, 5);
layout_vmargin(layout2, 4, 5);
layout_vmargin(layout2, 5, 5);
layout_vmargin(layout2, 6, 5);
layout_hmargin(layout1, 0, 10);
panel_layout(panel, layout1);
return panel;
}

```

27.10. Hello TextView!

Listing 27.9: demo/guihello/textviews.c

```

/* Use of textviews */

#include "textviews.h"
#include "res_guihello.h"
#include <gui/guiall.h>

/*-----*/

static void i_set_rtf(TextView *text)
{
    ResPack *pack = res_guihello_respack("");
    uint32_t size = 0;
}

```

From RTF data

What is Lorem Ipsum?

Lorem Ipsum is **simply** dummy text of the *printing and typesetting* industry. **Lorem Ipsum** has been the [industry's standard] dummy text ever ~~since the 1500s~~, when an **unknown printer** took a galley of type and scrambled it to make a type specimen book. It has survived not only five centuries, but also the leap into electronic typesetting, remaining essentially unchanged.

Hard coding

What is Lorem Ipsum?

Lorem Ipsum is **simply** dummy text of the *printing and typesetting* industry. **Lorem Ipsum** has been the [industry's standard] dummy text ever ~~since the 1500s~~, when an **unknown printer** took a galley of type and scrambled it to make a type specimen book. It has survived not only five centuries, but also the leap into electronic typesetting, remaining essentially unchanged.

Figure 27.10: Rich text control.

```

const byte_t *data = respack_file(pack, TEXTVIEW_RTF, &size);
Stream *stm = stm_from_block(data, size);
textview_rtf(text, stm);
stm_close(&stm);
respack_destroy(&pack);
}

/*-----*/

static void i_set_hard_coding(TextView *text)
{
    textview_units(text, ekFPOINTS);
    textview_lspacing(text, 1.15f);
    textview_afspace(text, 10);
    textview_family(text, "Arial");
}

```

```

textview_fsize(text, 16);
textview_writef(text, "What is Lorem Ipsum?\n");
textview_fsize(text, 11);
textview_writef(text, "Lorem Ipsum ");
textview_fstyle(text, ekFBOLD);
textview_writef(text, "is simply");
textview_fstyle(text, ekFNORMAL);
textview_writef(text, " dummy text of the ");
textview_fstyle(text, ekFITALIC);
textview_writef(text, "printing and typesetting ");
textview_fstyle(text, ekFNORMAL);
textview_writef(text, "industry. ");
textview_fsize(text, 16);
textview_color(text, color_rgb(255, 0, 0));
textview_writef(text, "Lorem Ipsum ");
textview_color(text, kCOLOR_DEFAULT);
textview_fsize(text, 11);
textview_writef(text, "has been the ");
textview_family(text, "Courier New");
textview_fsize(text, 14);
textview_writef(text, "[industry's standard] ");
textview_family(text, "Arial");
textview_fsize(text, 11);
textview_fstyle(text, ekFUNDERLINE);
textview_writef(text, "dummy text");
textview_fstyle(text, ekFNORMAL);
textview_writef(text, " ever ");
textview_fstyle(text, ekFSTRIKEOUT);
textview_writef(text, "since the 1500s");
textview_fstyle(text, ekFNORMAL);
textview_writef(text, ", when an ");
textview_color(text, color_rgb(0, 176, 80));
textview_writef(text, "unknown printer ");
textview_color(text, kCOLOR_DEFAULT);
textview_writef(text, "took a galley of type and scrambled it to make a
    ↪ type specimen book");
textview_fstyle(text, ekFITALIC);
textview_color(text, color_rgb(0, 77, 187));
textview_bgcolor(text, color_rgb(192, 192, 192));
textview_writef(text, ". It has survived not only five centuries");
textview_fstyle(text, ekFNORMAL);
textview_color(text, kCOLOR_DEFAULT);
textview_bgcolor(text, kCOLOR_DEFAULT);
textview_writef(text, ", but also the leap into electronic typesetting,
    ↪ remaining essentially unchanged.");
}

/*-----*/

Panel *textviews(void)
{

```

```

Layout *layout = layout_create(1, 4);
Label *label1 = label_create();
Label *label2 = label_create();
TextView *text1 = textview_create();
TextView *text2 = textview_create();
Panel *panel = panel_create();
label_text(label1, "From RTF data");
label_text(label2, "Hard coding");
textview_size(text1, s2df(450, 250));
textview_size(text2, s2df(450, 250));
i_set_rtf(text1);
i_set_hard_coding(text2);
layout_label(layout, label1, 0, 0);
layout_label(layout, label2, 0, 2);
layout_textview(layout, text1, 0, 1);
layout_textview(layout, text2, 0, 3);
layout_vmargn(layout, 0, 5);
layout_vmargn(layout, 1, 10);
layout_vmargn(layout, 2, 5);
panel_layout(panel, layout);
return panel;
}

```

27.11. Hello TableView!

Listing 27.10: demo/guihello/table.c

```

/* Use of tables */

#include "table.h"
#include <gui/guiall.h>

typedef struct _appdata_t AppData;

struct _appdata_t
{
    TableView *table;
    TextView *text;
    char_t temp_string[256];
};

/*-----*/

static void i_destroy_appdata(AppData **data)
{
    heap_delete(data, AppData);
}

/*-----*/

```

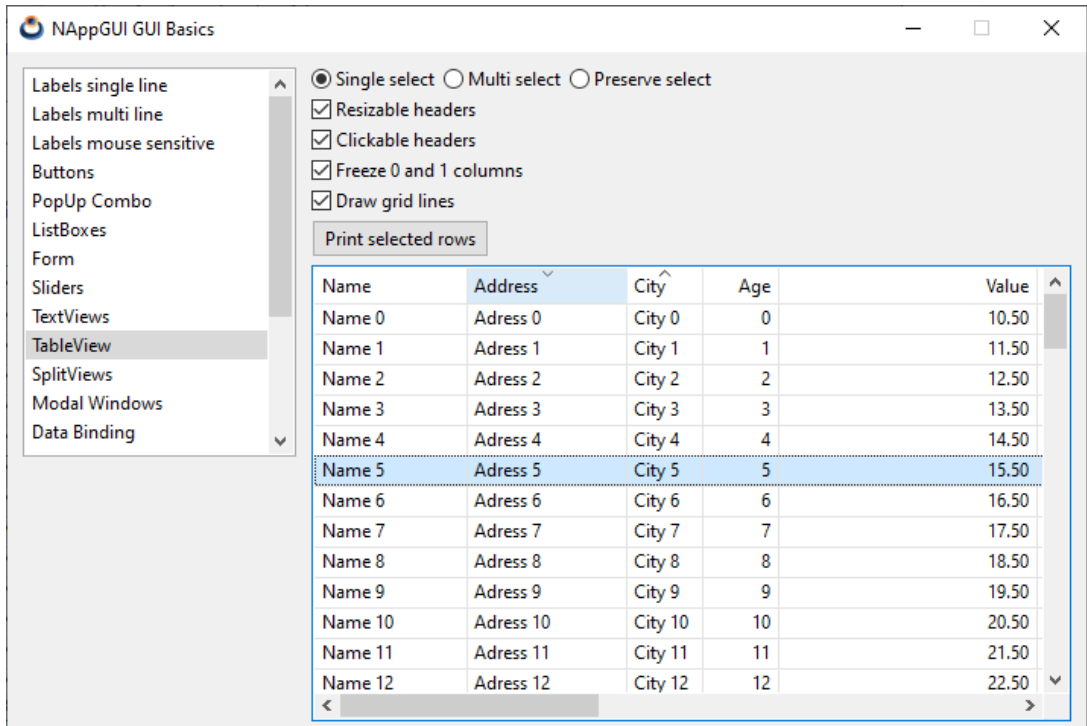

Figure 27.11: Table control.

```

/* AppData must contain the real data access(array, stream, etc) */
static void i_OnTableData(AppData *data, Event *e)
{
    uint32_t etype = event_type(e);

    switch (etype)
    {
    case ekGUI_EVENT_TBL_NROWS:
    {
        uint32_t *n = event_result(e, uint32_t);
        *n = 100;
        break;
    }

    case ekGUI_EVENT_TBL_CELL:
    {
        const EvTbPos *pos = event_params(e, EvTbPos);
        EvTbCell *cell = event_result(e, EvTbCell);

        switch (pos->col)
        {
        case 0:
            cell->align = ekLEFT;
        }
    }
    }
}

```

```

    bstd_sprintf(data->temp_string, sizeof(data->temp_string), "Name %d
    ↪ ", pos->row);
    break;

case 1:
    cell->align = ekLEFT;
    bstd_sprintf(data->temp_string, sizeof(data->temp_string), "Adress
    ↪ %d", pos->row);
    break;

case 2:
    cell->align = ekLEFT;
    bstd_sprintf(data->temp_string, sizeof(data->temp_string), "City %d
    ↪ ", pos->row);
    break;

case 3:
    cell->align = ekRIGHT;
    bstd_sprintf(data->temp_string, sizeof(data->temp_string), "%d",
    ↪ pos->row);
    break;

case 4:
    cell->align = ekRIGHT;
    bstd_sprintf(data->temp_string, sizeof(data->temp_string), "%.2f",
    ↪ 10.5f + pos->row);
    break;

case 5:
    cell->align = ekCENTER;
    bstd_sprintf(data->temp_string, sizeof(data->temp_string), "Extra
    ↪ Data 1 %d", pos->row);
    break;

case 6:
    cell->align = ekCENTER;
    bstd_sprintf(data->temp_string, sizeof(data->temp_string), "Extra
    ↪ Data 2 %d", pos->row);
    break;

case 7:
    cell->align = ekCENTER;
    bstd_sprintf(data->temp_string, sizeof(data->temp_string), "Extra
    ↪ Data 3 %d", pos->row);
    break;

case 8:
    cell->align = ekCENTER;
    bstd_sprintf(data->temp_string, sizeof(data->temp_string), "Extra
    ↪ Data 4 %d", pos->row);
    break;

```

```

        cassert_default();
    }

    cell->text = data->temp_string;
    break;
}
}
}

/*-----*/

static void i_OnHeaderClick(AppData *data, Event *e)
{
    const EvButton *p = event_params(e, EvButton);
    textview_printf(data->text, "Click on Header: %d\n", p->index);
}

/*-----*/

static void i_OnMultisel(AppData *data, Event *e)
{
    const EvButton *p = event_params(e, EvButton);
    if (p->index == 0)
        tableview_multisel(data->table, FALSE, FALSE);
    else if (p->index == 1)
        tableview_multisel(data->table, TRUE, FALSE);
    else if (p->index == 2)
        tableview_multisel(data->table, TRUE, TRUE);
}

/*-----*/

static void i_OnResizeCheck(AppData *data, Event *e)
{
    const EvButton *p = event_params(e, EvButton);
    bool_t resizable = p->state == ekGUI_ON ? TRUE : FALSE;
    tableview_header_resizable(data->table, resizable);
}

/*-----*/

static void i_OnHeaderCheck(AppData *data, Event *e)
{
    const EvButton *p = event_params(e, EvButton);
    bool_t clickable = p->state == ekGUI_ON ? TRUE : FALSE;
    tableview_header_clickable(data->table, clickable);
}

/*-----*/

```

```

static void i_OnFreezeCheck(AppData *data, Event *e)
{
    const EvButton *p = event_params(e, EvButton);
    uint32_t col_freeze = p->state == ekGUI_ON ? 1 : UINT32_MAX;
    tableview_column_freeze(data->table, col_freeze);
}

/*-----*/

static void i_OnGridCheck(AppData *data, Event *e)
{
    const EvButton *p = event_params(e, EvButton);
    bool_t grid = p->state == ekGUI_ON ? TRUE : FALSE;
    tableview_grid(data->table, grid, grid);
}

/*-----*/

static void i_OnPrintsel(AppData *data, Event *e)
{
    const ArrSt(uint32_t) *sel = tableview_selected(data->table);
    uint32_t n = arrst_size(sel, uint32_t);
    textview_writeln(data->text, "Selected rows: ");
    arrst_foreach_const(row, sel, uint32_t)
        textview_printf(data->text, "%d", *row);
    if (row_i < n - 1)
        textview_writeln(data->text, ", ");
    arrst_end();
    textview_writeln(data->text, "\n");
    unref(e);
}

/*-----*/

static Layout *i_table_control_layout(AppData *data)
{
    Layout *layout1 = layout_create(3, 1);
    Layout *layout2 = layout_create(1, 6);
    Button *button1 = button_radio();
    Button *button2 = button_radio();
    Button *button3 = button_radio();
    Button *button4 = button_check();
    Button *button5 = button_check();
    Button *button6 = button_check();
    Button *button7 = button_check();
    Button *button8 = button_push();
    button_text(button1, "Single select");
    button_text(button2, "Multi select");
    button_text(button3, "Preserve select");
    button_text(button4, "Resizable headers");
    button_text(button5, "Clickable headers");
}

```



```

button_text(button6, "Freeze 0 and 1 columns");
button_text(button7, "Draw grid lines");
button_text(button8, "Print selected rows");
button_state(button1, ekGUI_ON);
button_state(button4, ekGUI_ON);
button_state(button5, ekGUI_ON);
button_state(button6, ekGUI_ON);
button_state(button7, ekGUI_ON);
layout_button(layout1, button1, 0, 0);
layout_button(layout1, button2, 1, 0);
layout_button(layout1, button3, 2, 0);
layout_layout(layout2, layout1, 0, 0);
layout_button(layout2, button4, 0, 1);
layout_button(layout2, button5, 0, 2);
layout_button(layout2, button6, 0, 3);
layout_button(layout2, button7, 0, 4);
layout_button(layout2, button8, 0, 5);
layout_hmargin(layout1, 0, 5.f);
layout_hmargin(layout1, 1, 5.f);
layout_vmargn(layout2, 0, 5.f);
layout_vmargn(layout2, 1, 5.f);
layout_vmargn(layout2, 2, 5.f);
layout_vmargn(layout2, 3, 5.f);
layout_vmargn(layout2, 4, 5.f);
layout_halign(layout2, 0, 0, ekLEFT);
layout_halign(layout2, 0, 5, ekLEFT);
button_OnClick(button1, listener(data, i_OnMultisel, AppData));
button_OnClick(button2, listener(data, i_OnMultisel, AppData));
button_OnClick(button3, listener(data, i_OnMultisel, AppData));
button_OnClick(button4, listener(data, i_OnResizeCheck, AppData));
button_OnClick(button5, listener(data, i_OnHeaderCheck, AppData));
button_OnClick(button6, listener(data, i_OnFreezeCheck, AppData));
button_OnClick(button7, listener(data, i_OnGridCheck, AppData));
button_OnClick(button8, listener(data, i_OnPrintsel, AppData));
return layout2;
}

/*-----*/

Panel *table_view(void)
{
    Panel *panel = panel_create();
    AppData *data = heap_new0(AppData);
    TableView *table = tableview_create();
    TextView *text = textview_create();
    Layout *layout1 = layout_create(1, 3);
    Layout *layout2 = i_table_control_layout(data);
    data->table = table;
    data->text = text;
    tableview_size(table, s2df(500, 300));
    tableview_OnData(table, listener(data, i_OnTableData, AppData));
}

```

```

tableView_OnHeaderClick(table, listener(data, i_OnHeaderClick, AppData));
tableView_new_column_text(table);
tableView_new_column_text(table);
tableView_new_column_text(table);
tableView_new_column_text(table);
tableView_new_column_text(table);
tableView_new_column_text(table);
tableView_new_column_text(table);
tableView_new_column_text(table);
tableView_new_column_text(table);
tableView_header_clickable(table, TRUE);
tableView_header_resizable(table, TRUE);
tableView_header_indicator(table, 1, ekINDDOWN_ARROW);
tableView_header_indicator(table, 2, ekINDUP_ARROW);
tableView_header_title(table, 0, "Name");
tableView_header_title(table, 1, "Address");
tableView_header_title(table, 2, "City");
tableView_header_title(table, 3, "Age");
tableView_header_title(table, 4, "Value");
tableView_header_title(table, 5, "Extra\nData 1");
tableView_header_title(table, 6, "Extra\nData 2");
tableView_header_title(table, 7, "Extra\nData 3");
tableView_header_title(table, 8, "Extra\nData 4");
tableView_column_width(table, 0, 100);
tableView_column_width(table, 1, 105);
tableView_column_width(table, 2, 50);
tableView_column_width(table, 3, 50);
tableView_column_width(table, 4, 170);
tableView_column_width(table, 5, 200);
tableView_column_width(table, 6, 200);
tableView_column_width(table, 7, 200);
tableView_column_width(table, 8, 200);
tableView_column_limits(table, 2, 50, 100);
tableView_column_freeze(table, 1);
tableView_header_align(table, 0, ekLEFT);
tableView_header_align(table, 1, ekLEFT);
tableView_header_align(table, 2, ekLEFT);
tableView_header_align(table, 3, ekRIGHT);
tableView_header_align(table, 4, ekRIGHT);
tableView_header_align(table, 5, ekCENTER);
tableView_header_align(table, 6, ekCENTER);
tableView_header_align(table, 7, ekCENTER);
tableView_header_align(table, 8, ekCENTER);
tableView_multisel(table, FALSE, FALSE);
tableView_header_visible(table, TRUE);
tableView_grid(table, TRUE, TRUE);
tableView_update(table);

{
    uint32_t row = 20;
    tableView_select(table, &row, 1);
}

```

```

        tableview_focus_row(table, row, ekBOTTOM);
    }

    layout_layout(layout1, layout2, 0, 0);
    layout_tableview(layout1, table, 0, 1);
    layout_textview(layout1, text, 0, 2);
    layout_vmargin(layout1, 0, 5.f);
    layout_vmargin(layout1, 1, 5.f);
    panel_data(panel, &data, i_destroy_appdata, AppData);
    panel_layout(panel, layout1);
    return panel;
}

```

27.12. Hello SplitView!

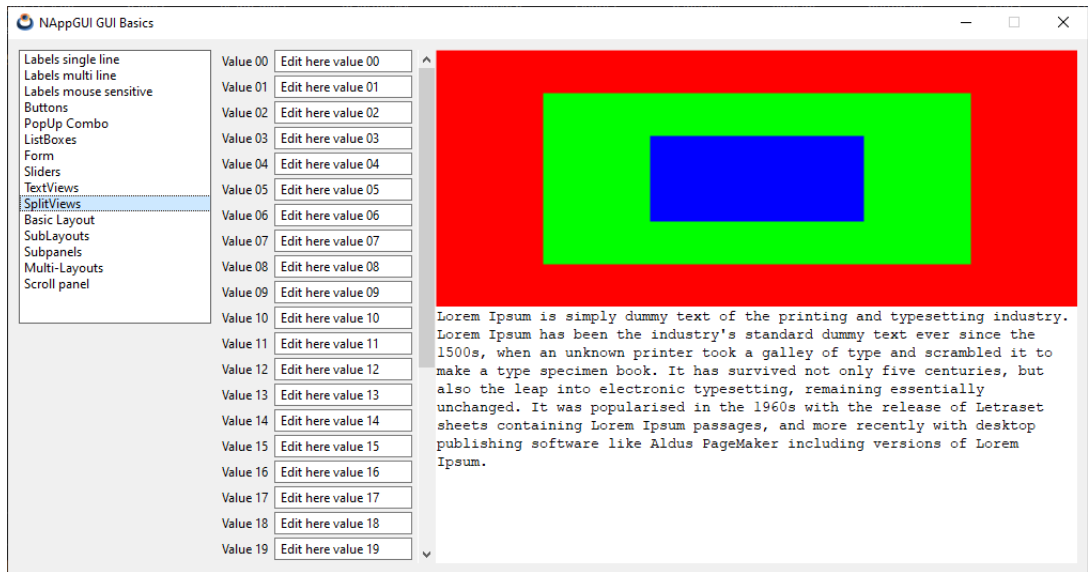

Figure 27.12: SplitView.

Listing 27.11: demo/guihello/splits.c

```

/* Use of splitviews */

#include "splits.h"
#include <gui/guiall.h>

static const char_t *i_LOREM = "Lorem Ipsum is simply dummy text of the
    ↳ printing and typesetting industry. Lorem Ipsum has been the industry's
    ↳ standard dummy text ever since the 1500s, when an unknown printer took a
    ↳ galley of type and scrambled it to make a type specimen book. It has
    ↳ survived not only five centuries, but also the leap into electronic

```

- ↪ typesetting, remaining essentially unchanged. It was popularised in the
- ↪ 1960s with the release of Letraset sheets containing Lorem Ipsum
- ↪ passages, and more recently with desktop publishing software like Aldus
- ↪ PageMaker including versions of Lorem Ipsum.";

```

/*-----*/

static void i_OnDraw(View *view, Event *e)
{
    const EvDraw *p = event_params(e, EvDraw);
    real32_t p0 = p->width / 6;
    real32_t p1 = p->height / 6;
    real32_t p2 = p->width / 3;
    real32_t p3 = p->height / 3;
    unref(view);
    draw_fill_color(p->ctx, kCOLOR_RED);
    draw_rect(p->ctx, ekFILL, 0, 0, p->width, p->height);
    draw_fill_color(p->ctx, kCOLOR_GREEN);
    draw_rect(p->ctx, ekFILL, p0, p1, p->width - 2 * p0, p->height - 2 * p1);
    draw_fill_color(p->ctx, kCOLOR_BLUE);
    draw_rect(p->ctx, ekFILL, p2, p3, p->width - 2 * p2, p->height - 2 * p3);
}

/*-----*/

static Panel *i_left_panel(void)
{
    uint32_t i, n = 32;
    Panel *panel = panel_scroll(FALSE, TRUE);
    Layout *layout = layout_create(2, n);
    real32_t rmargin = panel_scroll_width(panel);

    for (i = 0; i < n; ++i)
    {
        char_t text[64];
        Label *label = label_create();
        Edit *edit = edit_create();
        bstd_sprintf(text, sizeof(text), "Value %02d", i);
        label_text(label, text);
        bstd_sprintf(text, sizeof(text), "Edit here value %02d", i);
        edit_text(edit, text);
        layout_label(layout, label, 0, i);
        layout_edit(layout, edit, 1, i);
    }

    for (i = 0; i < n - 1; ++i)
        layout_vmargn(layout, i, 3);

    layout_hmargin(layout, 0, 5);
    layout_margin4(layout, 0, rmargin + 5, 0, 0);
    layout_hexpand(layout, 1);
}

```

```

    panel_layout(panel, layout);
    return panel;
}

/*-----*/

Panel *split_panel(void)
{
    Panel *panel1 = panel_create();
    Panel *panel2 = i_left_panel();
    Layout *layout = layout_create(1, 1);
    SplitView *split1 = splitview_vertical();
    SplitView *split2 = splitview_horizontal();
    TextView *text = textview_create();
    View *view = view_create();
    textview_writeln(text, i_LOREM);
    view_OnDraw(view, listener(view, i_OnDraw, View));
    splitview_pos(split1, .25f);
    splitview_size(split1, s2df(800, 480));
    splitview_size(split2, s2df(640, 480));
    splitview_view(split2, view, FALSE);
    splitview_text(split2, text, FALSE);
    splitview_panel(split1, panel2);
    splitview_split(split1, split2);
    layout_splitview(layout, split1, 0, 0);
    panel_layout(panel1, layout);
    return panel1;
}

```

27.13. Hello Modal Window!

Listing 27.12: demo/guihello/modalwin.c

```

/* Listboxes */

#include "modalwin.h"
#include <gui/guiall.h>

typedef struct _modal_data_t ModalData;

struct _modal_data_t
{
    uint32_t type;
    Label *label;
    Window *parent;
};

/*-----*/

static const char_t *i_MODAL0 = "Modal Window without [Return] nor [Esc]";

```

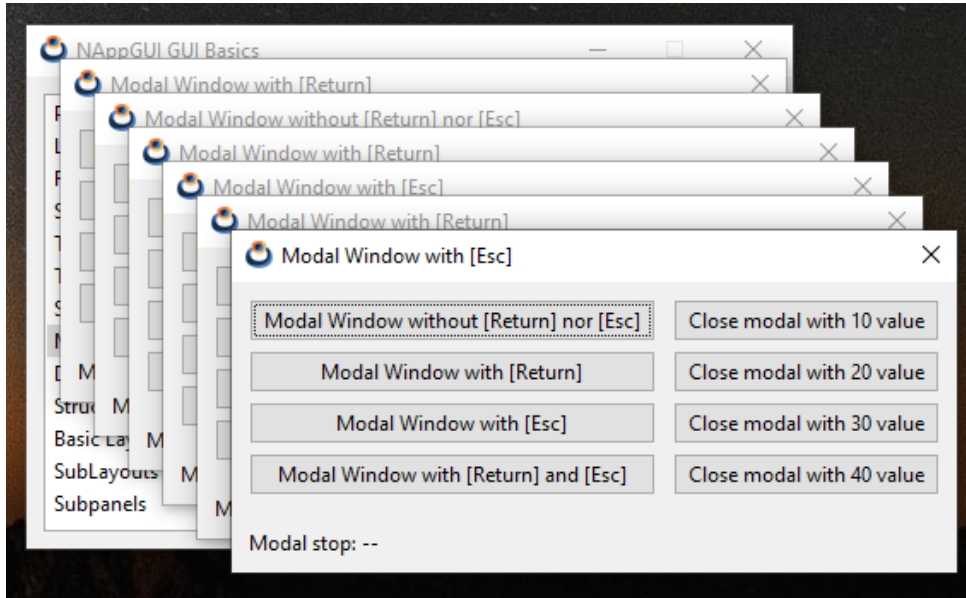

Figure 27.13: Modal windows.

```

static const char_t *i_MODAL1 = "Modal Window with [Return]";
static const char_t *i_MODAL2 = "Modal Window with [Esc]";
static const char_t *i_MODAL3 = "Modal Window with [Return] and [Esc]";

/*-----*/

static Layout *i_modal_layout(ModalData *data);

/*-----*/

static ModalData* i_modal_data(Window* parent)
{
    ModalData *data = heap_new0(ModalData);
    data->parent = parent;
    data->type = UINT32_MAX;
    return data;
}

/*-----*/

static void i_destroy_modal_data(ModalData** data)
{
    heap_delete(data, ModalData);
}

/*-----*/

```

```

static void i_OnCloseModal(Window* window, Event* e)
{
    Button *button = event_sender(e, Button);
    window_stop_modal(window, button_get_tag(button));
}

/*-----*/

static Layout* i_close_layout(Window *window)
{
    Layout *layout = layout_create(1, 4);
    Button *button1 = button_push();
    Button *button2 = button_push();
    Button *button3 = button_push();
    Button *button4 = button_push();
    button_text(button1, "Close modal with 10 value");
    button_text(button2, "Close modal with 20 value");
    button_text(button3, "Close modal with 30 value");
    button_text(button4, "Close modal with 40 value");
    button_tag(button1, 10);
    button_tag(button2, 20);
    button_tag(button3, 30);
    button_tag(button4, 40);
    button_OnClick(button1, listener(window, i_OnCloseModal, Window));
    button_OnClick(button2, listener(window, i_OnCloseModal, Window));
    button_OnClick(button3, listener(window, i_OnCloseModal, Window));
    button_OnClick(button4, listener(window, i_OnCloseModal, Window));
    layout_button(layout, button1, 0, 0);
    layout_button(layout, button2, 0, 1);
    layout_button(layout, button3, 0, 2);
    layout_button(layout, button4, 0, 3);
    layout_vmargen(layout, 0, 5);
    layout_vmargen(layout, 1, 5);
    layout_vmargen(layout, 2, 5);
    return layout;
}

/*-----*/

static uint32_t i_window_flags(const uint32_t type)
{
    uint32_t flags = ekWINDOW_TITLE | ekWINDOW_CLOSE;
    switch(type) {
        case 0:
            return flags;
        case 1:
            return flags | ekWINDOW_RETURN;
        case 2:
            return flags | ekWINDOW_ESC;
        case 3:
            return flags | ekWINDOW_RETURN | ekWINDOW_ESC;
    }
}

```

```

    cassert_default();
}

return 0;
}

/*-----*/

static const char_t *i_window_title(const uint32_t type)
{
    switch(type) {
    case 0:
        return i_MODAL0;
    case 1:
        return i_MODAL1;
    case 2:
        return i_MODAL2;
    case 3:
        return i_MODAL3;
    cassert_default();
    }

    return 0;
}

/*-----*/

static void i_modal_window(ModalData *data)
{
    uint32_t flags = i_window_flags(data->type);
    Window *window = window_create(flags);
    ModalData *ndata = i_modal_data(window);
    Panel *panel = panel_create();
    Layout *layout1 = layout_create(2, 1);
    Layout *layout2 = i_modal_layout(ndata);
    Layout *layout3 = i_close_layout(window);
    uint32_t retval = UINT32_MAX;
    V2Df pos = window_get_origin(data->parent);
    char_t text[128];
    layout_layout(layout1, layout2, 0, 0);
    layout_layout(layout1, layout3, 1, 0);
    layout_hmargin(layout1, 0, 10);
    layout_valign(layout1, 1, 0, ekTOP);
    layout_margin(layout1, 10);
    panel_data(panel, &ndata, i_destroy_modal_data, ModalData);
    panel_layout(panel, layout1);
    window_panel(window, panel);
    window_title(window, i_window_title(data->type));
    window_origin(window, v2df(pos.x + 20, pos.y + 20));
    retval = window_modal(window, data->parent);
}

```



```

    if (retval == (uint32_t)ekGUI_CLOSE_ESC)
        bstd_sprintf(text, sizeof(text), "Modal stop: [Esc] (%d)", retval);
    else if (retval == (uint32_t)ekGUI_CLOSE_INTRO)
        bstd_sprintf(text, sizeof(text), "Modal stop: [Return] (%d)", retval);
    else if (retval == (uint32_t)ekGUI_CLOSE_BUTTON)
        bstd_sprintf(text, sizeof(text), "Modal stop: [X] (%d)", retval);
    else
        bstd_sprintf(text, sizeof(text), "Modal stop: %d", retval);

    label_text(data->label, text);
    window_destroy(&window);
}

/*-----*/

static void i_OnClickModal(ModalData* data, Event* e)
{
    Button *button = event_sender(e, Button);
    data->type = button_get_tag(button);
    i_modal_window(data);
}

/*-----*/

static Layout *i_modal_layout(ModalData *data)
{
    Layout *layout = layout_create(1, 5);
    Button *button1 = button_push();
    Button *button2 = button_push();
    Button *button3 = button_push();
    Button *button4 = button_push();
    Label *label = label_create();
    cassert(data->label == NULL);
    data->label = label;
    button_text(button1, i_MODAL0);
    button_text(button2, i_MODAL1);
    button_text(button3, i_MODAL2);
    button_text(button4, i_MODAL3);
    label_text(label, "Modal stop: --");
    button_tag(button1, 0);
    button_tag(button2, 1);
    button_tag(button3, 2);
    button_tag(button4, 3);
    button_OnClick(button1, listener(data, i_OnClickModal, ModalData));
    button_OnClick(button2, listener(data, i_OnClickModal, ModalData));
    button_OnClick(button3, listener(data, i_OnClickModal, ModalData));
    button_OnClick(button4, listener(data, i_OnClickModal, ModalData));
    layout_button(layout, button1, 0, 0);
    layout_button(layout, button2, 0, 1);
    layout_button(layout, button3, 0, 2);
    layout_button(layout, button4, 0, 3);
}

```

```

layout_label(layout, label, 0, 4);
layout_halign(layout, 0, 4, ekJUSTIFY);
layout_vmargin(layout, 0, 5);
layout_vmargin(layout, 1, 5);
layout_vmargin(layout, 2, 5);
layout_vmargin(layout, 3, 20);
return layout;
}

/*-----*/

Panel *modal_windows(Window *parent)
{
    Panel *panel = panel_create();
    ModalData *data = i_modal_data(parent);
    Layout *layout = i_modal_layout(data);
    panel_layout(panel, layout);
    panel_data(panel, &data, i_destroy_modal_data, ModalData);
    return panel;
}

```

27.14. Hello Overlay Window!

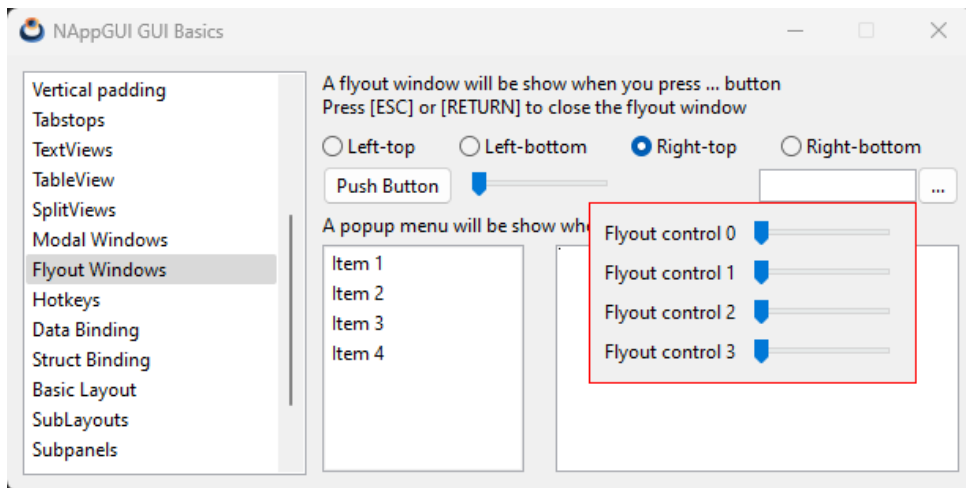

Figure 27.14: Overlay windows.

Listing 27.13: demo/guihello/flyout.c

```

/* Flyout window */

#include "flyout.h"
#include <gui/guiall.h>

```

```

typedef struct _flyout_t FlyOut;

struct _flyout_t
{
    Window *parent;
    Window *flywin;
    Menu *menu;
    TextView *text;
    GuiControl *edit;
    uint32_t align;
};

/*-----*/

static void i_destroy_flyout(FlyOut **flyout)
{
    cassert_no_null(flyout);
    cassert_no_null(*flyout);
    window_destroy(&(*flyout)->flywin);
    if ((*flyout)->menu != NULL)
        menu_destroy(&(*flyout)->menu);
    heap_delete(flyout, FlyOut);
}

/*-----*/

static Window *i_create_flywin(void)
{
    uint32_t nrows = 4;
    Layout *layout = layout_create(2, nrows);
    Panel *panel = panel_create();
    Window *window = window_create(ekWINDOW_RETURN | ekWINDOW_ESC);
    uint32_t i;

    for (i = 0; i < nrows; ++i)
    {
        char_t text[64];
        Label *label = label_create();
        Slider *slider = slider_create();
        bstd_sprintf(text, sizeof(text), "Flyout control %d", i);
        label_text(label, text);
        layout_label(layout, label, 0, i);
        layout_slider(layout, slider, 1, i);

        if (i < nrows - 1)
            layout_vmargin(layout, i, 5);
    }

    layout_hmargin(layout, 0, 5);
    layout_margin(layout, 10);
    layout_skcolor(layout, kCOLOR_RED);
}

```

```

panel_layout(panel, layout);
window_panel(window, panel);
return window;
}

/*-----*/

static void i_OnIdleLaunch(FlyOut *flyout, Event *e)
{
    /* Edit control bounds in window coordinates */
    R2Df frame = window_control_frame(flyout->parent, flyout->edit);
    /* Top-Left edit control in screen coordinates */
    V2Df pos = window_client_to_screen(flyout->parent, frame.pos);
    /* Flyout window size */
    S2Df size = window_get_size(flyout->flywin);

    switch (flyout->align) {
    case 0:
        pos.y += frame.size.height;
        break;
    case 1:
        pos.y -= size.height;
        break;
    case 2:
        pos.x -= size.width - frame.size.width;
        pos.y += frame.size.height;
        break;
    case 3:
        pos.x -= size.width - frame.size.width;
        pos.y -= size.height;
        break;
    }

    /* Position in screen coordinates */
    window_origin(flyout->flywin, pos);
    window_overlay(flyout->flywin, flyout->parent);
    unref(e);
}

/*-----*/

static void i_OnClick(FlyOut *flyout, Event *e)
{
    gui_OnIdle(listener(flyout, i_OnIdleLaunch, FlyOut));
    unref(e);
}

/*-----*/

static Layout *i_controls_layout(FlyOut *flyout)
{

```

```

Layout *layout = layout_create(5, 1);
Button *button1 = button_push();
Button *button2 = button_push();
Slider *slider = slider_create();
Edit *edit = edit_create();
button_text(button1, "Push Button");
button_text(button2, "...");
button_OnClick(button2, listener(flyout, i_OnClick, FlyOut));
layout_button(layout, button1, 0, 0);
layout_button(layout, button2, 4, 0);
layout_slider(layout, slider, 1, 0);
layout_edit(layout, edit, 3, 0);
layout_hmargin(layout, 0, 5);
layout_hmargin(layout, 1, 5);
layout_hexpand(layout, 2);
flyout->edit = guicontrol(edit);
return layout;
}

/*-----*/

static void i_OnAlign(FlyOut *flyout, Event *e)
{
    const EvButton *p = event_params(e, EvButton);
    cassert_no_null(flyout);
    flyout->align = p->index;
}

/*-----*/

static Layout *i_align_layout(FlyOut *flyout)
{
    Layout *layout = layout_create(4, 1);
    Button *button1 = button_radio();
    Button *button2 = button_radio();
    Button *button3 = button_radio();
    Button *button4 = button_radio();
    button_text(button1, "Left-top");
    button_text(button2, "Left-bottom");
    button_text(button3, "Right-top");
    button_text(button4, "Right-bottom");
    button_OnClick(button1, listener(flyout, i_OnAlign, FlyOut));
    layout_button(layout, button1, 0, 0);
    layout_button(layout, button2, 1, 0);
    layout_button(layout, button3, 2, 0);
    layout_button(layout, button4, 3, 0);
    layout_hmargin(layout, 0, 5);
    layout_hmargin(layout, 1, 5);
    layout_hmargin(layout, 2, 5);
    button_state(button1, ekGUI_ON);
    return layout;
}

```

```

}

/*-----*/

static void i_OnMenu(FlyOut *flyout, Event *e)
{
    const EvMenu *p = event_params(e, EvMenu);
    textview_writef(flyout->text, p->text);
    textview_writef(flyout->text, "\n");
}

/*-----*/

static void i_OnDown(FlyOut *flyout, Event *e)
{
    const EvMouse *p = event_params(e, EvMouse);
    if (p->button == ekGUI_MOUSE_RIGHT && p->tag != UINT32_MAX)
    {
        uint32_t i = 0;

        if (flyout->menu != NULL)
            menu_destroy(&flyout->menu);

        flyout->menu = menu_create();

        for (i = 0; i < 4; ++i)
        {
            char_t text[64];
            MenuItem *item = menuitem_create();
            bstd_sprintf(text, sizeof(text), "Item %d Option %d", p->tag + 1, i
                ↪ + 1);
            menuitem_text(item, text);
            menuitem_OnClick(item, listener(flyout, i_OnMenu, FlyOut));
            menu_item(flyout->menu, item);
        }

        {
            V2Df pos = gui_mouse_pos();
            menu_launch(flyout->menu, pos);
        }
    }
}

/*-----*/

static Layout *i_listbox_layout(FlyOut *flyout)
{
    Layout *layout = layout_create(2, 1);
    ListBox *list = listbox_create();
    TextView *text = textview_create();
    listbox_add_elem(list, "Item 1", NULL);
}

```

```

listbox_add_elem(list, "Item 2", NULL);
listbox_add_elem(list, "Item 3", NULL);
listbox_add_elem(list, "Item 4", NULL);
listbox_OnDown(list, listener(flyout, i_OnDown, FlyOut));
layout_listbox(layout, list, 0, 0);
layout_textview(layout, text, 1, 0);
layout_hmargin(layout, 0, 20);
flyout->text = text;
return layout;
}

/*-----*/

static Layout *i_layout(FlyOut *flyout)
{
    Layout *layout1 = layout_create(1, 5);
    Layout *layout2 = i_align_layout(flyout);
    Layout *layout3 = i_controls_layout(flyout);
    Layout *layout4 = i_listbox_layout(flyout);
    Label *label1 = label_multiline();
    Label *label2 = label_create();
    label_text(label1, "A flyout window will be show when you press ... button\
    ↪ nPress [ESC] or [RETURN] to close the flyout window");
    label_text(label2, "A popup menu will be show when right click in ListBox"
    ↪ );
    layout_label(layout1, label1, 0, 0);
    layout_layout(layout1, layout2, 0, 1);
    layout_layout(layout1, layout3, 0, 2);
    layout_label(layout1, label2, 0, 3);
    layout_layout(layout1, layout4, 0, 4);
    layout_vmargin(layout1, 0, 10);
    layout_vmargin(layout1, 1, 5);
    layout_vmargin(layout1, 2, 5);
    layout_vmargin(layout1, 3, 5);
    return layout1;
}

/*-----*/

static FlyOut *i_flyout(Window *window)
{
    FlyOut *flyout = heap_new(FlyOut);
    flyout->parent = window;
    flyout->flywin = i_create_flywin();
    flyout->menu = NULL;
    flyout->align = 0;
    return flyout;
}

/*-----*/

```

```

Panel *flyout_window(Window *window)
{
    FlyOut *flyout = i_flyout(window);
    Layout *layout = i_layout(flyout);
    Panel *panel = panel_create();
    panel_data(panel, &flyout, i_destroy_flyout, FlyOut);
    panel_layout(panel, layout);
    return panel;
}

```

27.15. Hello Gui Binding!

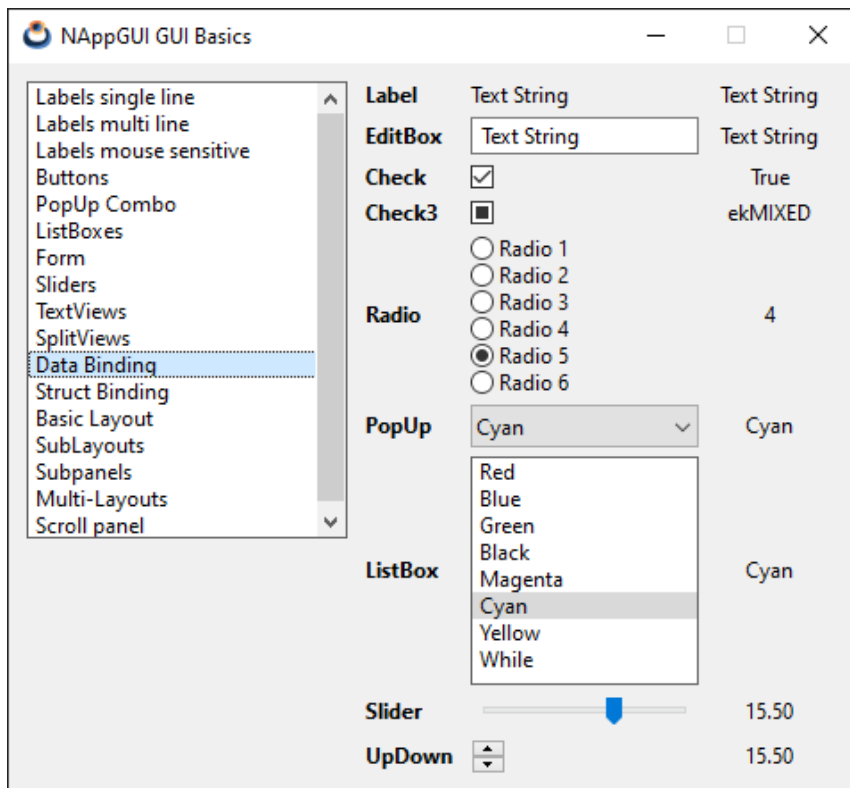

Figure 27.15: Gui Data binding.

Listing 27.14: demo/guihello/guibind.c

```

/* GUI data binding */

#include "guibind.h"
#include <gui/guiall.h>

typedef struct _basictypes_t BasicTypes;

```



```

typedef enum _myenum_t
{
    ekRED,
    ekBLUE,
    ekGREEN,
    ekBLACK,
    ekMAGENTA,
    ekCYAN,
    ekYELLOW,
    ekWHITE
} myenum_t;

struct _basictypes_t
{
    bool_t bool_val;
    uint16_t uint16_val;
    real32_t real32_val;
    myenum_t enum_val;
    gui_state_t enum3_val;
    String* str_val;
};

#define i_NUM_CONTROLS 9

static bool_t i_DATA_BINDED = FALSE;

/*-----*/

static void i_data_bind(void)
{
    if (i_DATA_BINDED == FALSE)
    {
        dbind_enum(gui_state_t, ekGUI_OFF, "");
        dbind_enum(gui_state_t, ekGUI_ON, "");
        dbind_enum(gui_state_t, ekGUI_MIXED, "");
        dbind_enum(myenum_t, ekRED, "Red");
        dbind_enum(myenum_t, ekBLUE, "Blue");
        dbind_enum(myenum_t, ekGREEN, "Green");
        dbind_enum(myenum_t, ekBLACK, "Black");
        dbind_enum(myenum_t, ekMAGENTA, "Magenta");
        dbind_enum(myenum_t, ekCYAN, "Cyan");
        dbind_enum(myenum_t, ekYELLOW, "Yellow");
        dbind_enum(myenum_t, ekWHITE, "While");
        dbind(BasicTypes, bool_t, bool_val);
        dbind(BasicTypes, uint16_t, uint16_val);
        dbind(BasicTypes, real32_t, real32_val);
        dbind(BasicTypes, gui_state_t, enum3_val);
        dbind(BasicTypes, myenum_t, enum_val);
        dbind(BasicTypes, String *, str_val);
        dbind_range(BasicTypes, real32_t, real32_val, -50, 50);
    }
}

```

```

        dbind_increment(BasicTypes, real32_t, real32_val, 5);
        i_DATA_BINDED = TRUE;
    }
}

/*-----*/

static void i_destroy_data(BasicTypes **data)
{
    str_destroy(&(*data)->str_val);
    heap_delete(data, BasicTypes);
}

/*-----*/

static Layout *i_radio_layout(void)
{
    uint32_t i = 0, n = 6;
    Layout *layout = layout_create(1, n);
    for (i = 0; i < n; ++i)
    {
        Button *radio = button_radio();
        char_t str[64];
        bstd_sprintf(str, sizeof(str), "Radio %d", i + 1);
        button_text(radio, str);
        layout_button(layout, radio, 0, i);
    }

    return layout;
}

/*-----*/

static void i_title_labels(Layout* layout)
{
    Font* font = font_system(font_regular_size(), ekFBOLD);
    const char_t* strs[] = { "Label", "EditBox", "Check", "Check3", "Radio", "
    ↪ PopUp", "ListBox", "Slider", "UpDown" };
    uint32_t i = 0;
    for (i = 0; i < i_NUM_CONTROLS; ++i)
    {
        Label* label = label_create();
        label_text(label, strs[i]);
        label_font(label, font);
        layout_label(layout, label, 0, i);
    }

    layout_hmargin(layout, 0, 10);
    font_destroy(&font);
}

```

```

/*-----*/

static void i_value_labels(Layout* layout)
{
    uint32_t i = 0;
    for (i = 0; i < i_NUM_CONTROLS; ++i)
    {
        Label* label = label_create();
        label_align(label, ekCENTER);
        layout_label(layout, label, 2, i);
        layout_halign(layout, 2, i, ekJUSTIFY);
    }

    layout_hsize(layout, 2, 80);
    layout_hmargin(layout, 0, 10);
    for (i = 0; i < i_NUM_CONTROLS - 1; ++i)
        layout_vmargin(layout, i, 5);

    cell_dbind(layout_cell(layout, 2, 0), BasicTypes, String*, str_val);
    cell_dbind(layout_cell(layout, 2, 1), BasicTypes, String*, str_val);
    cell_dbind(layout_cell(layout, 2, 2), BasicTypes, bool_t, bool_val);
    cell_dbind(layout_cell(layout, 2, 3), BasicTypes, gui_state_t, enum3_val);
    cell_dbind(layout_cell(layout, 2, 4), BasicTypes, uint16_t, uint16_val);
    cell_dbind(layout_cell(layout, 2, 5), BasicTypes, myenum_t, enum_val);
    cell_dbind(layout_cell(layout, 2, 6), BasicTypes, myenum_t, enum_val);
    cell_dbind(layout_cell(layout, 2, 7), BasicTypes, real32_t, real32_val);
    cell_dbind(layout_cell(layout, 2, 8), BasicTypes, real32_t, real32_val);
}

/*-----*/

static Layout *i_layout(void)
{
    Layout *layout = layout_create(3, 9);
    Label *label = label_create();
    Edit *edit = edit_create();
    Button *check = button_check();
    Button *check3 = button_check3();
    Layout *radios = i_radio_layout();
    PopUp *popup = popup_create();
    ListBox *listbox = listbox_create();
    Slider *slider = slider_create();
    UpDown *updown = updown_create();
    layout_label(layout, label, 1, 0);
    layout_edit(layout, edit, 1, 1);
    layout_button(layout, check, 1, 2);
    layout_button(layout, check3, 1, 3);
    layout_layout(layout, radios, 1, 4);
    layout_popup(layout, popup, 1, 5);
    layout_listbox(layout, listbox, 1, 6);
    layout_slider(layout, slider, 1, 7);
}

```

```

layout_updown(layout, updown, 1, 8);
layout_halign(layout, 1, 0, ekJUSTIFY);
layout_halign(layout, 1, 8, ekLEFT);
cell_dbind(layout_cell(layout, 1, 0), BasicTypes, String*, str_val);
cell_dbind(layout_cell(layout, 1, 1), BasicTypes, String*, str_val);
cell_dbind(layout_cell(layout, 1, 2), BasicTypes, bool_t, bool_val);
cell_dbind(layout_cell(layout, 1, 3), BasicTypes, gui_state_t, enum3_val);
cell_dbind(layout_cell(layout, 1, 4), BasicTypes, uint16_t, uint16_val);
cell_dbind(layout_cell(layout, 1, 5), BasicTypes, myenum_t, enum_val);
cell_dbind(layout_cell(layout, 1, 6), BasicTypes, myenum_t, enum_val);
cell_dbind(layout_cell(layout, 1, 7), BasicTypes, real32_t, real32_val);
cell_dbind(layout_cell(layout, 1, 8), BasicTypes, real32_t, real32_val);
i_title_labels(layout);
i_value_labels(layout);
return layout;
}

/*-----*/

Panel* guibind(void)
{
    Layout *layout = NULL;
    Panel *panel = NULL;
    BasicTypes *data = heap_new(BasicTypes);
    i_data_bind();
    layout = i_layout();
    panel = panel_create();
    panel_layout(panel, layout);
    data->bool_val = TRUE;
    data->uint16_val = 4;
    data->real32_val = 15.5f;
    data->enum3_val = ekGUI_MIXED;
    data->enum_val = ekCYAN;
    data->str_val = str_c("Text String");
    layout_dbind(layout, NULL, BasicTypes);
    layout_dbind_obj(layout, data, BasicTypes);
    panel_data(panel, &data, i_destroy_data, BasicTypes);
    return panel;
}

```

27.16. Hello Struct Binding!

Listing 27.15: demo/guihello/layoutbind.c

```

/* GUI data binding */

#include "layoutbind.h"
#include <gui/guiall.h>

typedef struct _vector_t Vector;

```

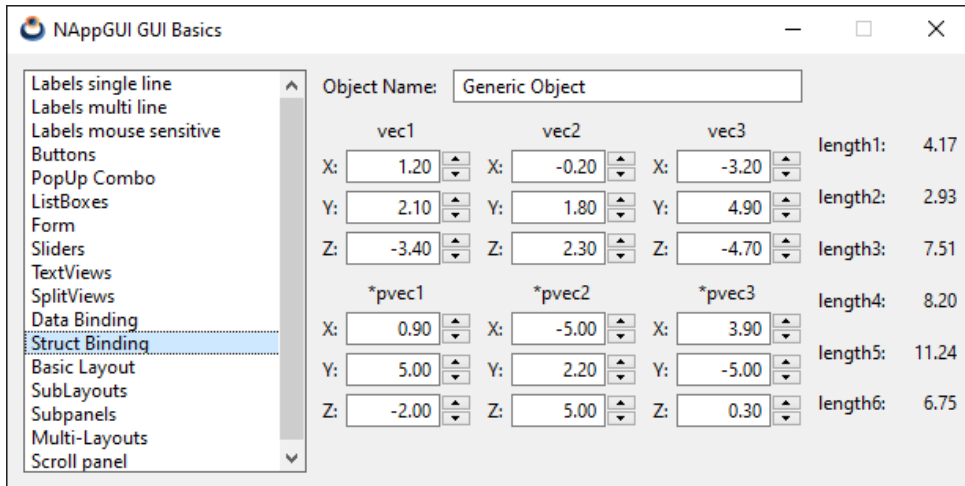

Figure 27.16: Gui Struct binding.

```

typedef struct _structtypes_t StructTypes;

struct _vector_t
{
    real32_t x;
    real32_t y;
    real32_t z;
};

struct _structtypes_t
{
    String *name;
    Vector vec1;
    Vector vec2;
    Vector vec3;
    Vector *pvec1;
    Vector *pvec2;
    Vector *pvec3;
    real32_t length1;
    real32_t length2;
    real32_t length3;
    real32_t length4;
    real32_t length5;
    real32_t length6;
};

static bool_t i_DATA_BINDED = FALSE;

/*-----*/

static void i_data_bind(void)

```

```

{
    if (i_DATA_BINDED == TRUE)
        return;

    dbind(Vector, real32_t, x);
    dbind(Vector, real32_t, y);
    dbind(Vector, real32_t, z);
    dbind(StructTypes, String *, name);
    dbind(StructTypes, Vector, vec1);
    dbind(StructTypes, Vector, vec2);
    dbind(StructTypes, Vector, vec3);
    dbind(StructTypes, Vector *, pvec1);
    dbind(StructTypes, Vector *, pvec2);
    dbind(StructTypes, Vector *, pvec3);
    dbind(StructTypes, real32_t, length1);
    dbind(StructTypes, real32_t, length2);
    dbind(StructTypes, real32_t, length3);
    dbind(StructTypes, real32_t, length4);
    dbind(StructTypes, real32_t, length5);
    dbind(StructTypes, real32_t, length6);
    dbind_range(Vector, real32_t, x, -5, 5);
    dbind_range(Vector, real32_t, y, -5, 5);
    dbind_range(Vector, real32_t, z, -5, 5);
    dbind_increment(Vector, real32_t, x, .1f);
    dbind_increment(Vector, real32_t, y, .1f);
    dbind_increment(Vector, real32_t, z, .1f);
    i_DATA_BINDED = TRUE;
}

/*-----*/

static void i_destroy_data(StructTypes **data)
{
    str_destroy(&(*data)->name);
    heap_delete(&(*data)->pvec1, Vector);
    heap_delete(&(*data)->pvec2, Vector);
    heap_delete(&(*data)->pvec3, Vector);
    heap_delete(data, StructTypes);
}

/*-----*/

static Vector i_vec_init(const real32_t x, const real32_t y, const real32_t z)
{
    Vector v;
    v.x = x;
    v.y = y;
    v.z = z;
    return v;
}

```

```

/*-----*/

static real32_t i_vec_length(const Vector *vec)
{
    real32_t n = vec->x * vec->x + vec->y * vec->y + vec->z * vec->z;
    return bmath_sqrtf(n);
}

/*-----*/

static void i_OnDataChange(void *non_used, Event *e)
{
    StructTypes *data = evbind_object(e, StructTypes);
    Layout *layout = event_sender(e, Layout);
    unref(non_used);

    if (evbind_modify(e, StructTypes, Vector, vec1) == TRUE)
    {
        data->length1 = i_vec_length(&data->vec1);
        layout_dbind_update(layout, StructTypes, real32_t, length1);
    }
    else if (evbind_modify(e, StructTypes, Vector, vec2) == TRUE)
    {
        data->length2 = i_vec_length(&data->vec2);
        layout_dbind_update(layout, StructTypes, real32_t, length2);
    }
    else if (evbind_modify(e, StructTypes, Vector, vec3) == TRUE)
    {
        data->length3 = i_vec_length(&data->vec3);
        layout_dbind_update(layout, StructTypes, real32_t, length3);
    }
    else if (evbind_modify(e, StructTypes, Vector*, pvec1) == TRUE)
    {
        data->length4 = i_vec_length(data->pvec1);
        layout_dbind_update(layout, StructTypes, real32_t, length4);
    }
    else if (evbind_modify(e, StructTypes, Vector*, pvec2) == TRUE)
    {
        data->length5 = i_vec_length(data->pvec2);
        layout_dbind_update(layout, StructTypes, real32_t, length5);
    }
    else if (evbind_modify(e, StructTypes, Vector*, pvec3) == TRUE)
    {
        data->length6 = i_vec_length(data->pvec3);
        layout_dbind_update(layout, StructTypes, real32_t, length6);
    }
}

/*-----*/

static Layout *i_vector_layout(void)

```

```

{
    Layout *layout = layout_create(3, 3);
    Label *label1 = label_create();
    Label *label2 = label_create();
    Label *label3 = label_create();
    Edit *edit1 = edit_create();
    Edit *edit2 = edit_create();
    Edit *edit3 = edit_create();
    UpDown *updown1 = updown_create();
    UpDown *updown2 = updown_create();
    UpDown *updown3 = updown_create();
    label_text(label1, "X:");
    label_text(label2, "Y:");
    label_text(label3, "Z:");
    edit_align(edit1, ekRIGHT);
    edit_align(edit2, ekRIGHT);
    edit_align(edit3, ekRIGHT);
    layout_label(layout, label1, 0, 0);
    layout_label(layout, label2, 0, 1);
    layout_label(layout, label3, 0, 2);
    layout_edit(layout, edit1, 1, 0);
    layout_edit(layout, edit2, 1, 1);
    layout_edit(layout, edit3, 1, 2);
    layout_updown(layout, updown1, 2, 0);
    layout_updown(layout, updown2, 2, 1);
    layout_updown(layout, updown3, 2, 2);
    layout_hmargin(layout, 0, 5);
    layout_vmargn(layout, 0, 5);
    layout_vmargn(layout, 1, 5);
    layout_hsize(layout, 1, 60);
    cell_dbind(layout_cell(layout, 1, 0), Vector, real32_t, x);
    cell_dbind(layout_cell(layout, 1, 1), Vector, real32_t, y);
    cell_dbind(layout_cell(layout, 1, 2), Vector, real32_t, z);
    cell_dbind(layout_cell(layout, 2, 0), Vector, real32_t, x);
    cell_dbind(layout_cell(layout, 2, 1), Vector, real32_t, y);
    cell_dbind(layout_cell(layout, 2, 2), Vector, real32_t, z);
    layout_dbind(layout, NULL, Vector);
    return layout;
}

/*-----*/

static Layout *i_name_layout(void)
{
    Layout *layout = layout_create(2, 1);
    Label *label = label_create();
    Edit *edit = edit_create();
    label_text(label, "Object Name:");
    layout_hexpand(layout, 1);
    layout_label(layout, label, 0, 0);
    layout_edit(layout, edit, 1, 0);
}

```



```

    layout_hmargin(layout, 0, 10);
    cell_dbind(layout_cell(layout, 1, 0), StructTypes, String*, name);
    return layout;
}

/*-----*/

static Layout *i_vectors_layout(void)
{
    Layout *layout1 = layout_create(3, 4);
    Layout *layout2 = i_vector_layout();
    Layout *layout3 = i_vector_layout();
    Layout *layout4 = i_vector_layout();
    Layout *layout5 = i_vector_layout();
    Layout *layout6 = i_vector_layout();
    Layout *layout7 = i_vector_layout();
    Label *label1 = label_create();
    Label *label2 = label_create();
    Label *label3 = label_create();
    Label *label4 = label_create();
    Label *label5 = label_create();
    Label *label6 = label_create();
    label_text(label1, "vec1");
    label_text(label2, "vec2");
    label_text(label3, "vec3");
    label_text(label4, "*pvec1");
    label_text(label5, "*pvec2");
    label_text(label6, "*pvec3");
    layout_label(layout1, label1, 0, 0);
    layout_label(layout1, label2, 1, 0);
    layout_label(layout1, label3, 2, 0);
    layout_label(layout1, label4, 0, 2);
    layout_label(layout1, label5, 1, 2);
    layout_label(layout1, label6, 2, 2);
    layout_layout(layout1, layout2, 0, 1);
    layout_layout(layout1, layout3, 1, 1);
    layout_layout(layout1, layout4, 2, 1);
    layout_layout(layout1, layout5, 0, 3);
    layout_layout(layout1, layout6, 1, 3);
    layout_layout(layout1, layout7, 2, 3);
    layout_halign(layout1, 0, 0, ekCENTER);
    layout_halign(layout1, 1, 0, ekCENTER);
    layout_halign(layout1, 2, 0, ekCENTER);
    layout_halign(layout1, 0, 2, ekCENTER);
    layout_halign(layout1, 1, 2, ekCENTER);
    layout_halign(layout1, 2, 2, ekCENTER);
    layout_hmargin(layout1, 0, 10);
    layout_hmargin(layout1, 1, 10);
    layout_vmargin(layout1, 0, 5);
    layout_vmargin(layout1, 1, 10);
    layout_vmargin(layout1, 2, 5);
}

```

```

cell_dbind(layout_cell(layout1, 0, 1), StructTypes, Vector, vec1);
cell_dbind(layout_cell(layout1, 1, 1), StructTypes, Vector, vec2);
cell_dbind(layout_cell(layout1, 2, 1), StructTypes, Vector, vec3);
cell_dbind(layout_cell(layout1, 0, 3), StructTypes, Vector*, pvec1);
cell_dbind(layout_cell(layout1, 1, 3), StructTypes, Vector*, pvec2);
cell_dbind(layout_cell(layout1, 2, 3), StructTypes, Vector*, pvec3);
return layout1;
}

/*-----*/

static Layout *i_lengths_layout(void)
{
    Layout *layout = layout_create(2, 6);
    Label *label1 = label_create();
    Label *label2 = label_create();
    Label *label3 = label_create();
    Label *label4 = label_create();
    Label *label5 = label_create();
    Label *label6 = label_create();
    Label *label7 = label_create();
    Label *label8 = label_create();
    Label *label9 = label_create();
    Label *label10 = label_create();
    Label *label11 = label_create();
    Label *label12 = label_create();
    label_text(label1, "length1:");
    label_text(label2, "length2:");
    label_text(label3, "length3:");
    label_text(label4, "length4:");
    label_text(label5, "length5:");
    label_text(label6, "length6:");
    layout_label(layout, label1, 0, 0);
    layout_label(layout, label2, 0, 1);
    layout_label(layout, label3, 0, 2);
    layout_label(layout, label4, 0, 3);
    layout_label(layout, label5, 0, 4);
    layout_label(layout, label6, 0, 5);
    layout_label(layout, label7, 1, 0);
    layout_label(layout, label8, 1, 1);
    layout_label(layout, label9, 1, 2);
    layout_label(layout, label10, 1, 3);
    layout_label(layout, label11, 1, 4);
    layout_label(layout, label12, 1, 5);
    label_align(label7, ekRIGHT);
    label_align(label8, ekRIGHT);
    label_align(label9, ekRIGHT);
    label_align(label10, ekRIGHT);
    label_align(label11, ekRIGHT);
    label_align(label12, ekRIGHT);
    layout_hsize(layout, 1, 40);
}

```

```

    layout_hmargin(layout, 0, 5);
    layout_halign(layout, 1, 0, ekJUSTIFY);
    layout_halign(layout, 1, 1, ekJUSTIFY);
    layout_halign(layout, 1, 2, ekJUSTIFY);
    layout_halign(layout, 1, 3, ekJUSTIFY);
    layout_halign(layout, 1, 4, ekJUSTIFY);
    layout_halign(layout, 1, 5, ekJUSTIFY);
    cell_dbind(layout_cell(layout, 1, 0), StructTypes, real32_t, length1);
    cell_dbind(layout_cell(layout, 1, 1), StructTypes, real32_t, length2);
    cell_dbind(layout_cell(layout, 1, 2), StructTypes, real32_t, length3);
    cell_dbind(layout_cell(layout, 1, 3), StructTypes, real32_t, length4);
    cell_dbind(layout_cell(layout, 1, 4), StructTypes, real32_t, length5);
    cell_dbind(layout_cell(layout, 1, 5), StructTypes, real32_t, length6);
    return layout;
}

/*-----*/

static Layout *i_layout(void)
{
    Layout *layout1 = layout_create(2, 2);
    Layout *layout2 = i_name_layout();
    Layout *layout3 = i_vectors_layout();
    Layout *layout4 = i_lengths_layout();
    layout_layout(layout1, layout2, 0, 0);
    layout_layout(layout1, layout3, 0, 1);
    layout_layout(layout1, layout4, 1, 1);
    layout_hmargin(layout1, 0, 10);
    layout_vmargin(layout1, 0, 10);
    return layout1;
}

/*-----*/

Panel* layoutbind(void)
{
    Layout *layout = NULL;
    Panel *panel = NULL;
    StructTypes *data = heap_new(StructTypes);
    i_data_bind();
    layout = i_layout();
    panel = panel_create();
    panel_layout(panel, layout);
    data->name = str_c("Generic Object");
    data->pvec1 = heap_new(Vector);
    data->pvec2 = heap_new(Vector);
    data->pvec3 = heap_new(Vector);
    data->vec1 = i_vec_init(1.2f, 2.1f, -3.4f);
    data->vec2 = i_vec_init(-0.2f, 1.8f, 2.3f);
    data->vec3 = i_vec_init(-3.2f, 4.9f, -4.7f);
    *data->pvec1 = i_vec_init(0.9f, 7.9f, -2.0f);

```

```

*data->pvec2 = i_vec_init(-6.9f, 2.2f, 8.6f);
*data->pvec3 = i_vec_init(3.9f, -5.5f, 0.3f);
data->length1 = i_vec_length(&data->vec1);
data->length2 = i_vec_length(&data->vec2);
data->length3 = i_vec_length(&data->vec3);
data->length4 = i_vec_length(data->pvec1);
data->length5 = i_vec_length(data->pvec2);
data->length6 = i_vec_length(data->pvec3);
layout_dbind(layout, listener(NULL, i_OnDataChange, void), StructTypes);
layout_dbind_obj(layout, data, StructTypes);
panel_data(panel, &data, i_destroy_data, StructTypes);
return panel;
}

```

27.17. Hello Sublayout!

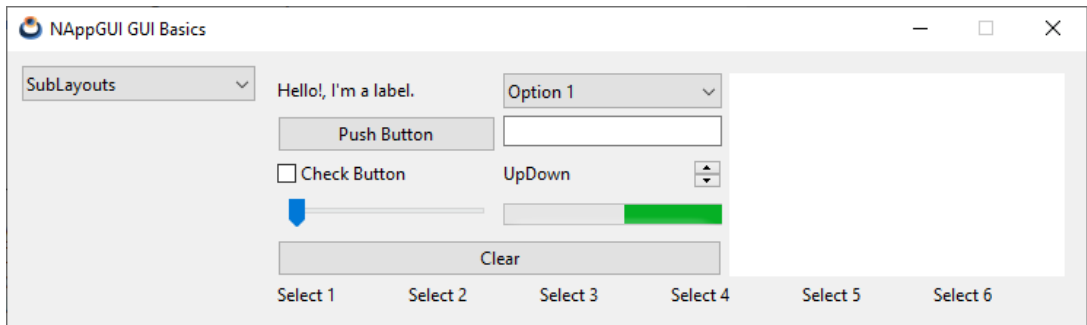

Figure 27.17: Sublayout composition.

Listing 27.16: demo/guihello/sublayout.c

```

/* Sublayouts */

#include "sublayout.h"
#include <gui/guiall.h>

/*-----*/

static Layout *i_updown_layout(void)
{
    Layout *layout = layout_create(2, 1);
    Label *label = label_create();
    UpDown *updown = updown_create();
    label_text(label, "UpDown");
    layout_label(layout, label, 0, 0);
    layout_updown(layout, updown, 1, 0);
    layout_hexpanse(layout, 0);
    return layout;
}

```

```

}

/*-----*/

static Layout *i_left_grid_layout(void)
{
    Layout *layout1 = layout_create(2, 4);
    Layout *layout2 = i_updown_layout();
    Label *label = label_create();
    Button *button1 = button_push();
    Button *button2 = button_check();
    Slider *slider = slider_create();
    PopUp *popup = popup_create();
    Edit *edit = edit_create();
    Progress *progress = progress_create();
    label_text(label, "Hello!, I'm a label.");
    button_text(button1, "Push Button");
    button_text(button2, "Check Button");
    popup_add_elem(popup, "Option 1", NULL);
    popup_add_elem(popup, "Option 2", NULL);
    popup_add_elem(popup, "Option 3", NULL);
    popup_add_elem(popup, "Option 4", NULL);
    progress_undefined(progress, TRUE);
    layout_label(layout1, label, 0, 0);
    layout_button(layout1, button1, 0, 1);
    layout_button(layout1, button2, 0, 2);
    layout_slider(layout1, slider, 0, 3);
    layout_popup(layout1, popup, 1, 0);
    layout_edit(layout1, edit, 1, 1);
    layout_layout(layout1, layout2, 1, 2);
    layout_progress(layout1, progress, 1, 3);
    layout_hsize(layout1, 0, 150);
    layout_hsize(layout1, 1, 150);
    layout_hmargin(layout1, 0, 5);
    layout_vmargin(layout1, 0, 5);
    layout_vmargin(layout1, 1, 5);
    layout_vmargin(layout1, 2, 5);
    return layout1;
}

/*-----*/

static Layout *i_left_layout(void)
{
    Layout *layout1 = layout_create(1, 2);
    Layout *layout2 = i_left_grid_layout();
    Button *button = button_push();
    button_text(button, "Clear");
    layout_layout(layout1, layout2, 0, 0);
    layout_button(layout1, button, 0, 1);
    layout_vmargin(layout1, 0, 5);
}

```

```

    return layout1;
}

/*-----*/

static Layout *i_top_layout(void)
{
    Layout *layout1 = layout_create(2, 1);
    Layout *layout2 = i_left_layout();
    TextView *view = textview_create();
    layout_layout(layout1, layout2, 0, 0);
    layout_textview(layout1, view, 1, 0);
    layout_hsize(layout1, 1, 230);
    layout_hmargin(layout1, 0, 5);
    return layout1;
}

/*-----*/

static Layout *i_bottom_layout(void)
{
    Layout *layout = layout_create(6, 1);
    Label *label1 = label_create();
    Label *label2 = label_create();
    Label *label3 = label_create();
    Label *label4 = label_create();
    Label *label5 = label_create();
    Label *label6 = label_create();
    label_text(label1, "Select 1");
    label_text(label2, "Select 2");
    label_text(label3, "Select 3");
    label_text(label4, "Select 4");
    label_text(label5, "Select 5");
    label_text(label6, "Select 6");
    label_style_over(label1, ekFUNDERLINE);
    label_style_over(label2, ekFUNDERLINE);
    label_style_over(label3, ekFUNDERLINE);
    label_style_over(label4, ekFUNDERLINE);
    label_style_over(label5, ekFUNDERLINE);
    label_style_over(label6, ekFUNDERLINE);
    layout_label(layout, label1, 0, 0);
    layout_label(layout, label2, 1, 0);
    layout_label(layout, label3, 2, 0);
    layout_label(layout, label4, 3, 0);
    layout_label(layout, label5, 4, 0);
    layout_label(layout, label6, 5, 0);
    return layout;
}

/*-----*/

```

```

static Layout *i_main_layout(void)
{
    Layout *layout1 = layout_create(1, 2);
    Layout *layout2 = i_top_layout();
    Layout *layout3 = i_bottom_layout();
    layout_layout(layout1, layout2, 0, 0);
    layout_layout(layout1, layout3, 0, 1);
    layout_margin(layout1, 5);
    layout_vmargin(layout1, 0, 5);
    return layout1;
}

/*-----*/

Panel *sublayouts(void)
{
    Panel *panel = panel_create();
    Layout *layout = i_main_layout();
    panel_layout(panel, layout);
    return panel;
}

```

27.18. Hello Subpanel!

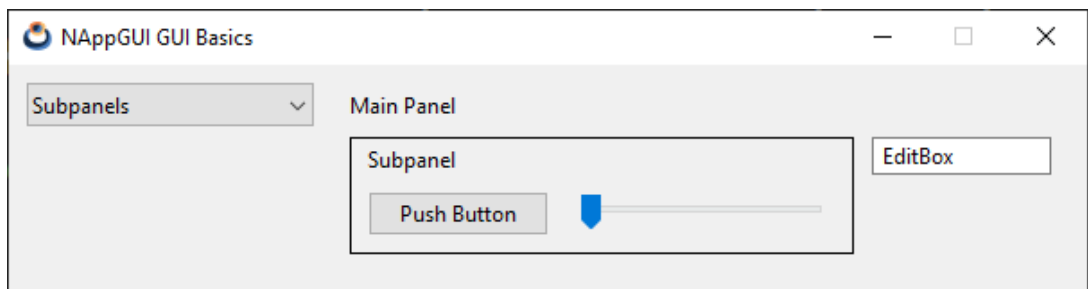

Figure 27.18: Subpanels.

Listing 27.17: demo/guihello/subpanel.c

```

/* Use of subpanels */

#include "subpanel.h"
#include <gui/guiall.h>

/*-----*/

Panel *subpanels(void)
{
    Panel *panel1 = panel_create();
    Panel *panel2 = panel_create();
}

```

```

Layout *layout1 = layout_create(2, 2);
Layout *layout2 = layout_create(2, 2);
Label *label1 = label_create();
Label *label2 = label_create();
Button *button = button_push();
Slider *slider = slider_create();
Edit *edit = edit_create();
label_text(label1, "Main Panel");
label_text(label2, "Subpanel");
button_text(button, "Push Button");
edit_text(edit, "EditBox");

layout_label(layout2, label2, 0, 0);
layout_button(layout2, button, 0, 1);
layout_slider(layout2, slider, 1, 1);
layout_hsize(layout2, 1, 150);
layout_hmargin(layout2, 0, 10);
layout_vmargin(layout2, 0, 10);
layout_margin4(layout2, 5, 10, 10, 10);
layout_skcolor(layout2, gui_line_color());
panel_layout(panel2, layout2);

layout_label(layout1, label1, 0, 0);
layout_edit(layout1, edit, 1, 1);
layout_panel(layout1, panel2, 0, 1);
layout_hsize(layout1, 1, 100);
layout_hmargin(layout1, 0, 10);
layout_vmargin(layout1, 0, 10);
layout_margin4(layout1, 5, 10, 10, 10);
panel_layout(panel1, layout1);
return panel1;
}

```

27.19. Hello Multi-layout!

Listing 27.18: demo/guihello/multilayout.c

```

/* Panels with multiple layouts */

#include "multilayout.h"
#include <gui/guiall.h>

/*-----*/

static Panel *i_multilayout_panel(void)
{
    Panel *panel = panel_create();
    Layout *layout1 = layout_create(2, 5);
    Layout *layout2 = layout_create(1, 10);
    Label *label1 = label_create();

```



Figure 27.19: Panel with two layouts.

```

Label *label2 = label_create();
Label *label3 = label_create();
Label *label4 = label_create();
Label *label5 = label_create();
Edit *edit1 = edit_create();
Edit *edit2 = edit_create();
Edit *edit3 = edit_create();
Edit *edit4 = edit_create();
Edit *edit5 = edit_create();
label_text(label1, "User Name:");
label_text(label2, "Password:");
label_text(label3, "Address:");
label_text(label4, "City:");
label_text(label5, "Phone:");
edit_text(edit1, "Amanda Callister");
edit_text(edit2, "aQwe56nhjJk");
edit_text(edit3, "35, Tuam Road");
edit_text(edit4, "Galway - Ireland");
edit_text(edit5, "+35 654 333 000");
edit_passmode(edit2, TRUE);

layout_label(layout1, label1, 0, 0);
layout_label(layout1, label2, 0, 1);
layout_label(layout1, label3, 0, 2);
layout_label(layout1, label4, 0, 3);
layout_label(layout1, label5, 0, 4);
layout_edit(layout1, edit1, 1, 0);
layout_edit(layout1, edit2, 1, 1);
layout_edit(layout1, edit3, 1, 2);
layout_edit(layout1, edit4, 1, 3);
layout_edit(layout1, edit5, 1, 4);
layout_hsize(layout1, 1, 300);
layout_hmargin(layout1, 0, 5);
layout_vmargin(layout1, 0, 5);

```

```

layout_vmargin(layout1, 1, 5);
layout_vmargin(layout1, 2, 5);
layout_vmargin(layout1, 3, 5);

layout_label(layout2, label1, 0, 0);
layout_label(layout2, label2, 0, 2);
layout_label(layout2, label3, 0, 4);
layout_label(layout2, label4, 0, 6);
layout_label(layout2, label5, 0, 8);
layout_edit(layout2, edit1, 0, 1);
layout_edit(layout2, edit2, 0, 3);
layout_edit(layout2, edit3, 0, 5);
layout_edit(layout2, edit4, 0, 7);
layout_edit(layout2, edit5, 0, 9);
layout_hsize(layout2, 0, 200);
layout_vmargin(layout2, 1, 5);
layout_vmargin(layout2, 3, 5);
layout_vmargin(layout2, 5, 5);
layout_vmargin(layout2, 7, 5);

panel_layout(panel, layout1);
panel_layout(panel, layout2);
return panel;
}

/*-----*/

static void i_OnLayout(Panel *panel, Event *e)
{
    const EvButton *params = event_params(e, EvButton);
    panel_visible_layout(panel, params->index);
    panel_update(panel);
}

/*-----*/

Panel *multilayouts(void)
{
    Panel *panel1 = panel_create();
    Panel *panel2 = i_multilayout_panel();
    Button *button1 = button_radio();
    Button *button2 = button_radio();
    Layout *layout1 = layout_create(1, 2);
    Layout *layout2 = layout_create(2, 1);
    button_text(button1, "Layout1");
    button_text(button2, "Layout2");
    button_state(button1, ekGUI_ON);
    button_OnClick(button1, listener(panel2, i_OnLayout, Panel));
    layout_button(layout2, button1, 0, 0);
    layout_button(layout2, button2, 1, 0);
    layout_layout(layout1, layout2, 0, 0);
}

```

```

layout_panel(layout1, panel2, 0, 1);
layout_vmargin(layout1, 0, 10);
layout_hmargin(layout2, 0, 10);
layout_halign(layout1, 0, 0, ekLEFT);
panel_layout(panel1, layout1);
return panel1;
}

```

27.20. Hello Scroll-Panel!

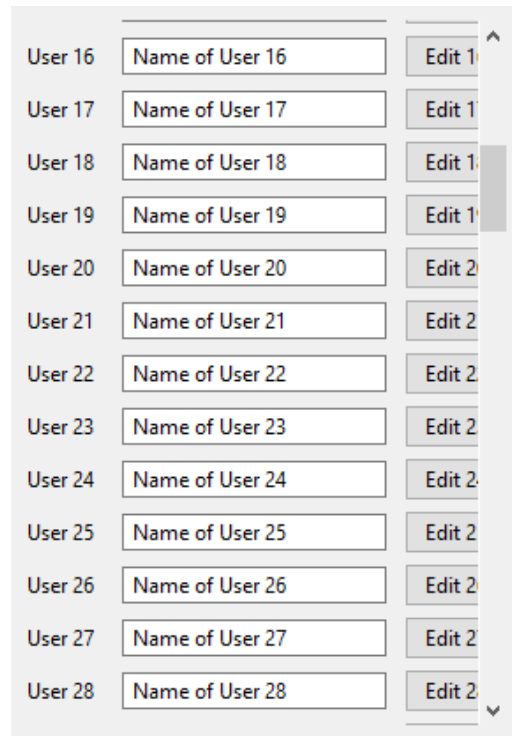

Figure 27.20: Panel with scroll bars.

Listing 27.19: demo/guihello/scrollpanel.c

```

/* Panel with scroll */

#include "scrollpanel.h"
#include <gui/guiall.h>

static const uint32_t i_ROWS = 100;

/*-----*/

Panel *scrollpanel(void)
{

```

```

Panel *panel = panel_scroll(FALSE, TRUE);
Layout *layout = layout_create(3, i_ROWS);
real32_t margin = panel_scroll_width(panel);
uint32_t i = 0;
panel_size(panel, s2df(-1, 400));
for (i = 0; i < i_ROWS; ++i)
{
    char_t text[128];
    Label *label = label_create();
    Edit *edit = edit_create();
    Button *button = button_push();
    bstd_sprintf(text, sizeof(text), "User %d", i + 1);
    label_text(label, text);
    bstd_sprintf(text, sizeof(text), "Name of User %d", i + 1);
    edit_text(edit, text);
    bstd_sprintf(text, sizeof(text), "Edit %d", i + 1);
    button_text(button, text);
    layout_label(layout, label, 0, i);
    layout_edit(layout, edit, 1, i);
    layout_button(layout, button, 2, i);
}

for (i = 0; i < i_ROWS - 1; ++i)
    layout_vmargin(layout, i, 5);

layout_hmargin(layout, 0, 10);
layout_hmargin(layout, 1, 10);
layout_hsize(layout, 1, 150);
layout_margin4(layout, 0, margin, 0, 0);
panel_layout(panel, layout);
return panel;
}

```

27.21. Hello Dynamic Layout!

Listing 27.20: demo/guihello/dynlay.c

```

/* Dynamic layouts */

#include "dynlay.h"
#include "res_guihello.h"
#include <gui/guiall.h>

typedef struct dyn_data_t DynData;

struct dyn_data_t
{
    Layout *top_layout;
    Layout *bottom_layout;
    uint32_t hmargin;
}

```

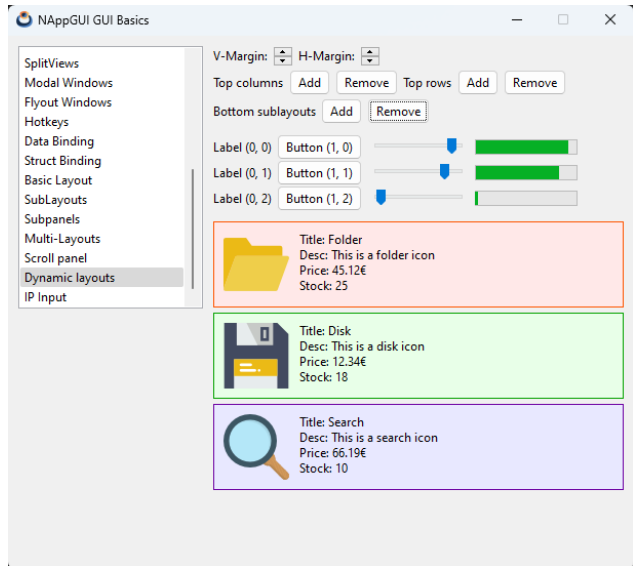

Figure 27.21: Add or delete content in a Layout.

```

uint32_t vmargin;
color_t bgcolor[3];
color_t skcolor[3];
};

/*-----*/

static void i_destroy_dyndata (DynData **data)
{
    heap_delete(data, DynData);
}

/*-----*/

static void i_top_layout_margins (DynData *data)
{
    uint32_t i, ncols, nrows;
    cassert_no_null(data);
    ncols = layout_ncols(data->top_layout);
    nrows = layout_nrows(data->top_layout);
    cassert(ncols >= 2); /* At lest one column and expand column */
    cassert(nrows >= 1); /* At lest one row */
    if (ncols > 2)
    {
        for (i = 0; i < ncols - 2; ++i)
            layout_hmargin(data->top_layout, i, (real32_t)data->hmargin);
    }

    if (nrows > 1)
    {

```

```

        for (i = 0; i < nrows - 1; ++i)
            layout_vmargin(data->top_layout, i, (real32_t)data->vmargin);
    }
}

/*-----*/

static void i_bottom_layout_margins(DynData *data)
{
    uint32_t i, nrows;
    cassert_no_null(data);
    nrows = layout_nrows(data->bottom_layout);
    cassert(nrows >= 1); /* At least one row */

    if (nrows > 1)
    {
        for (i = 0; i < nrows - 1; ++i)
            layout_vmargin(data->bottom_layout, i, 5);
    }
}

/*-----*/

static void i_OnVMargin(DynData *data, Event *e)
{
    const EvButton *p = event_params(e, EvButton);
    cassert_no_null(data);
    if (p->index == 1 && data->vmargin > 0)
        data->vmargin -= 1;
    else if (p->index == 0)
        data->vmargin += 1;
    i_top_layout_margins(data);
    layout_update(data->top_layout);
}

/*-----*/

static void i_OnHMargin(DynData *data, Event *e)
{
    const EvButton *p = event_params(e, EvButton);
    cassert_no_null(data);
    if (p->index == 1 && data->hmargin > 0)
        data->hmargin -= 1;
    else if (p->index == 0)
        data->hmargin += 1;
    i_top_layout_margins(data);
    layout_update(data->top_layout);
}

/*-----*/

```

```

static Layout *i_control_layout_1(DynData *data)
{
    Layout *layout = layout_create(5, 1);
    Label *label1 = label_create();
    Label *label2 = label_create();
    UpDown *updown1 = updown_create();
    UpDown *updown2 = updown_create();
    label_text(label1, "V-Margin:");
    label_text(label2, "H-Margin:");
    updown_OnClick(updown1, listener(data, i_OnVMargin, DynData));
    updown_OnClick(updown2, listener(data, i_OnHMargin, DynData));
    layout_label(layout, label1, 0, 0);
    layout_updown(layout, updown1, 1, 0);
    layout_label(layout, label2, 2, 0);
    layout_updown(layout, updown2, 3, 0);

    /*
     * Static margin between columns
     */
    layout_hmargin(layout, 0, 5);
    layout_hmargin(layout, 1, 5);
    layout_hmargin(layout, 2, 5);

    /*
     * By default, updown and button cells are JUSTIFICABLE
     * We force keep the buttons into their original size
     */
    layout_halign(layout, 1, 0, ekLEFT);
    layout_halign(layout, 3, 0, ekLEFT);

    /*
     * The horizontal expansion is delegated to a fifth empty cell.
     * This prevents excess pixels from being distributed across all columns,
     * keeping the left four columns together.
     */
    layout_hexpand(layout, 4);

    return layout;
}

/*-----*/

static void i_OnSlider(DynData *data, Event *e)
{
    Slider *slider = event_sender(e, Slider);
    GuiControl *control = guicontrol(slider);
    uint32_t tag = guicontrol_get_tag(control);
    uint32_t col = tag & 0x0000FFFF;
    uint32_t row = ((tag & 0xFFFF0000) >> 16);
    uint32_t ncols = layout_ncols(data->top_layout);

```

```

/* Exists a column at the right of slider */
if (ncols > col + 1)
{
    const EvSlider *p = event_params(e, EvSlider);
    /* The element at the right of slider is a progress always */
    Progress *progress = layout_get_progress(data->top_layout, col + 1, row
        ↪ );

    /* We syncro the progress with its neighbor slider */
    progress_value(progress, p->pos);
}
}

/*-----*/

static void i_fill_cell(Layout *layout, const uint32_t col, const uint32_t row,
    ↪ DynData *data)
{
    /* We are sure not to overwrite a cell */
    cassert(cell_empty(layout_cell(layout, col, row)) == TRUE);

    switch (col % 5) {
    case 0:
    {
        Label *label = label_create();
        String *text = str_printf("Label (%d, %d)", col, row);
        label_text(label, tc(text));
        layout_label(layout, label, col, row);
        str_destroy(&text);
        break;
    }

    case 1:
    {
        Button *button = button_push();
        String *text = str_printf("Button (%d, %d)", col, row);
        button_text(button, tc(text));
        layout_button(layout, button, col, row);
        str_destroy(&text);
        break;
    }

    case 2:
    {
        Slider *slider = slider_create();
        GuiControl *control = guicontrol(slider);
        real32_t pos = bmath_randf(0, 1);
        uint32_t tag = (row << 16) | col;
        slider_value(slider, pos);
        slider_OnMoved(slider, listener(data, i_OnSlider, DynData));
        guicontrol_tag(control, tag);
    }
}

```



```

        layout_slider(layout, slider, col, row);
        break;
    }

    case 3:
    {
        /* Progress is in syncro with its left slider */
        Progress *progress = progress_create();
        Slider *slider = layout_get_slider(layout, col - 1, row);
        real32_t pos = slider_get_value(slider);
        progress_value(progress, pos);
        layout_progress(layout, progress, col, row);
        break;
    }

    case 4:
    {
        PopUp *popup = popup_create();
        uint32_t i;
        for (i = 0; i < 5; ++i)
        {
            String *text = str_printf("Item (%d, %d) - %d", col, row, i);
            popup_add_elem(popup, tc(text), NULL);
            str_destroy(&text);
        }
        layout_popup(layout, popup, col, row);
        break;
    }
}

/*-----*/

static void i_fill_row(Layout *layout, const uint32_t row, DynData *data)
{
    uint32_t i, cols = layout_ncols(layout);
    cassert(cols > 1);
    for (i = 0; i < cols - 1; ++i)
        i_fill_cell(layout, i, row, data);
}

/*-----*/

static void i_fill_col(Layout *layout, const uint32_t col, DynData *data)
{
    uint32_t i, rows = layout_nrows(layout);
    cassert(rows > 1);
    for (i = 0; i < rows; ++i)
        i_fill_cell(layout, col, i, data);
}

```

```

/*-----*/

static const Image *i_image(const uint32_t row)
{
    switch (row % 6) {
        case 0:
            return gui_image(FOLDER64_PNG);
        case 1:
            return gui_image(DISK64_PNG);
        case 2:
            return gui_image(SEARCH64_PNG);
        case 3:
            return gui_image(EDIT64_PNG);
        case 4:
            return gui_image(PLUS64_PNG);
        case 5:
            return gui_image(ERROR64_PNG);
    }

    return NULL;
}

/*-----*/

static const char_t *i_title_text(const uint32_t row)
{
    switch (row % 6) {
        case 0:
            return "Title: Folder";
        case 1:
            return "Title: Disk";
        case 2:
            return "Title: Search";
        case 3:
            return "Title: Edit";
        case 4:
            return "Title: Plus";
        case 5:
            return "Title: Error";
    }

    return NULL;
}

/*-----*/

static const char_t *i_desc_text(const uint32_t row)
{
    switch (row % 6) {
        case 0:

```

```

        return "Desc: This is a folder icon";
    case 1:
        return "Desc: This is a disk icon";
    case 2:
        return "Desc: This is a search icon";
    case 3:
        return "Desc: This is a edit icon";
    case 4:
        return "Desc: This is a plus icon";
    case 5:
        return "Desc: This is a error icon";
    }

    return NULL;
}

/*-----*/

static const char_t *i_price_text(const uint32_t row)
{
    switch (row % 6) {
    case 0:
        return "Price: €45.12";
    case 1:
        return "Price: €12.34";
    case 2:
        return "Price: €66.19";
    case 3:
        return "Price: €22.65";
    case 4:
        return "Price: €99.99";
    case 5:
        return "Price: €32.56";
    }

    return NULL;
}

/*-----*/

static const char_t *i_stock_text(const uint32_t row)
{
    switch (row % 6) {
    case 0:
        return "Stock: 25";
    case 1:
        return "Stock: 18";
    case 2:
        return "Stock: 10";
    case 3:
        return "Stock: 22";
    }
}

```

```

    case 4:
        return "Stock: 7";
    case 5:
        return "Stock: 0";
    }

    return NULL;
}

/*-----*/

static void i_fill_sublayout(Layout *layout, const uint32_t row, DynData *data)
{
    /*
     * layout1 is a new row-sublayout added to bottom_layout
     * composed by tree cells:
     * Image cell
     * Data cell: vertical sublayout with 4 labels in a stack
     * Expand cell: Only for expand the excess of pixels of wider sublayout (
     *     ↪ top_layout)
     */
    Layout *layout1 = layout_create(3, 1);
    Layout *layout2 = layout_create(1, 4);
    ImageView *view = imageview_create();
    const Image *image = i_image(row);
    Label *label1 = label_create();
    Label *label2 = label_create();
    Label *label3 = label_create();
    Label *label4 = label_create();
    /* We are sure not to overwrite a cell */
    cassert(cell_empty(layout_cell(layout, 0, row)) == TRUE);
    imageview_image(view, image);
    layout_imageview(layout1, view, 0, 0);
    label_text(label1, i_title_text(row));
    label_text(label2, i_desc_text(row));
    label_text(label3, i_price_text(row));
    label_text(label4, i_stock_text(row));
    layout_label(layout2, label1, 0, 0);
    layout_label(layout2, label2, 0, 1);
    layout_label(layout2, label3, 0, 2);
    layout_label(layout2, label4, 0, 3);
    layout_layout(layout1, layout2, 1, 0);
    layout_valign(layout1, 0, 0, ekTOP);
    layout_valign(layout1, 1, 0, ekTOP);
    layout_hmargin(layout1, 0, 10);
    layout_hexpand(layout1, 2);
    layout_margin(layout1, 10);
    layout_bgcolor(layout1, data->bgcolor[row % 3]);
    layout_skcolor(layout1, data->skcolor[row % 3]);
    layout_layout(layout, layout1, 0, row);
}

```

```

/*-----*/

static void i_OnTopAddCol(DynData *data, Event *e)
{
    uint32_t ncols = 0;
    cassert_no_null(data);
    ncols = layout_ncols(data->top_layout);
    cassert(ncols > 1);
    unref(e);

    /* Insert new column in penultimate position. The last is the empty-
       ↪ resizable column */
    /* Because empty cells with 0-margin are added, the visual appearance does
       ↪ not change after insert */
    layout_insert_col(data->top_layout, ncols - 1);

    /* Add the new widget to recent-created cells */
    i_fill_col(data->top_layout, ncols - 1, data);

    /* Update the margins, because the new column has 0-margin */
    i_top_layout_margins(data);

    /* Recompute the layout appearance and update widgets */
    layout_update(data->top_layout);
}

/*-----*/

static void i_OnTopDelCol(DynData *data, Event *e)
{
    uint32_t ncols = 0;
    cassert_no_null(data);
    ncols = layout_ncols(data->top_layout);
    unref(e);
    if (ncols > 3)
    {
        layout_remove_col(data->top_layout, ncols - 2);

        /* Update the margins, because the new column has 0-margin */
        i_top_layout_margins(data);

        /* Recompute the layout appearance and update widgets */
        layout_update(data->top_layout);
    }
}

/*-----*/

static void i_OnTopAddRow(DynData *data, Event *e)
{

```

```

uint32_t nrows = 0;
cassert_no_null(data);
nrows = layout_nrows(data->top_layout);
cassert(nrows >= 1);
unref(e);

/* Insert new row in last position */
/* Because empty cells with 0-margin are added, the visual appearance does
   ↪ not change after insert */
layout_insert_row(data->top_layout, nrows);

/* Add the new widget to recent-created cells */
i_fill_row(data->top_layout, nrows, data);

/* Update the margins, because the new row has 0-margin */
i_top_layout_margins(data);

/* Recompute the layout appearance and update widgets */
layout_update(data->top_layout);
}

/*-----*/

static void i_OnTopDelRow(DynData *data, Event *e)
{
    uint32_t nrows = 0;
    cassert_no_null(data);
    nrows = layout_nrows(data->top_layout);
    unref(e);
    if (nrows > 2)
    {
        layout_remove_row(data->top_layout, nrows - 1);

        /* Update the margins, because the new column has 0-margin */
        i_top_layout_margins(data);

        /* Recompute the layout appearance and update widgets */
        layout_update(data->top_layout);
    }
}

/*-----*/

static void i_OnTopAddLayout(DynData *data, Event *e)
{
    uint32_t nrows = 0;
    cassert_no_null(data);
    nrows = layout_nrows(data->bottom_layout);
    cassert(nrows >= 1);
    unref(e);
}

```

```

    /* Insert new row in last position */
    layout_insert_row(data->bottom_layout, nrows);

    /* Add a new sublayout to last cell */
    i_fill_sublayout(data->bottom_layout, nrows, data);

    /* Update the margins, because the new row has 0-margin */
    i_bottom_layout_margins(data);

    /* Recompute the layout appearance and update widgets */
    layout_update(data->bottom_layout);
}

/*-----*/

static void i_OnTopDelLayout(DynData *data, Event *e)
{
    uint32_t nrows = 0;
    cassert_no_null(data);
    nrows = layout_nrows(data->bottom_layout);
    unref(e);

    if (nrows > 1)
    {
        /* Remove the row in last position */
        layout_remove_row(data->bottom_layout, nrows - 1);

        /* Update the margins, because the new row has 0-margin */
        i_bottom_layout_margins(data);

        /* Recompute the layout appearance and update widgets */
        layout_update(data->bottom_layout);
    }
}

/*-----*/

static Layout *i_control_layout_2(DynData *data)
{
    Layout *layout = layout_create(7, 1);
    Label *label1 = label_create();
    Label *label2 = label_create();
    Button *button1 = button_push();
    Button *button2 = button_push();
    Button *button3 = button_push();
    Button *button4 = button_push();
    label_text(label1, "Top columns");
    label_text(label2, "Top rows");
    button_text(button1, "Add");
    button_text(button2, "Remove");
    button_text(button3, "Add");

```

```

    button_text(button4, "Remove");
    button_OnClick(button1, listener(data, i_OnTopAddCol, DynData));
    button_OnClick(button2, listener(data, i_OnTopDelCol, DynData));
    button_OnClick(button3, listener(data, i_OnTopAddRow, DynData));
    button_OnClick(button4, listener(data, i_OnTopDelRow, DynData));
    layout_label(layout, label1, 0, 0);
    layout_button(layout, button1, 1, 0);
    layout_button(layout, button2, 2, 0);
    layout_label(layout, label2, 3, 0);
    layout_button(layout, button3, 4, 0);
    layout_button(layout, button4, 5, 0);
    layout_hmargin(layout, 0, 5);
    layout_hmargin(layout, 1, 5);
    layout_hmargin(layout, 2, 5);
    layout_hmargin(layout, 3, 5);
    layout_hmargin(layout, 4, 5);
    layout_halign(layout, 1, 0, ekLEFT);
    layout_halign(layout, 2, 0, ekLEFT);
    layout_halign(layout, 4, 0, ekLEFT);
    layout_halign(layout, 5, 0, ekLEFT);
    layout_hexpand(layout, 6);
    return layout;
}

/*-----*/

static Layout *i_control_layout_3(DynData *data)
{
    Layout *layout = layout_create(4, 1);
    Label *label = label_create();
    Button *button1 = button_push();
    Button *button2 = button_push();
    label_text(label, "Bottom sublayouts");
    button_text(button1, "Add");
    button_text(button2, "Remove");
    button_OnClick(button1, listener(data, i_OnTopAddLayout, DynData));
    button_OnClick(button2, listener(data, i_OnTopDelLayout, DynData));
    layout_label(layout, label, 0, 0);
    layout_button(layout, button1, 1, 0);
    layout_button(layout, button2, 2, 0);
    layout_hmargin(layout, 0, 5);
    layout_hmargin(layout, 1, 5);
    layout_halign(layout, 1, 0, ekLEFT);
    layout_halign(layout, 2, 0, ekLEFT);
    layout_hexpand(layout, 3);
    return layout;
}

/*-----*/

static Layout *i_control_layout(DynData *data)

```



```

{
    Layout *layout = layout_create(1, 3);
    Layout *layout1 = i_control_layout_1(data);
    Layout *layout2 = i_control_layout_2(data);
    Layout *layout3 = i_control_layout_3(data);
    layout_layout(layout, layout1, 0, 0);
    layout_layout(layout, layout2, 0, 1);
    layout_layout(layout, layout3, 0, 2);
    layout_vmargin(layout, 0, 3);
    layout_vmargin(layout, 1, 3);
    return layout;
}

/*-----*/

static Layout *i_top_layout(DynData *data)
{
    Layout *layout = layout_create(5, 3);
    i_fill_row(layout, 0, data);
    i_fill_row(layout, 1, data);
    i_fill_row(layout, 2, data);
    layout_hexpend(layout, 4);
    return layout;
}

/*-----*/

static Layout *i_bottom_layout(DynData *data)
{
    Layout *layout = layout_create(1, 3);
    i_fill_sublayout(layout, 0, data);
    i_fill_sublayout(layout, 1, data);
    i_fill_sublayout(layout, 2, data);
    return layout;
}

/*-----*/

static DynData *i_panel_data(void)
{
    DynData *data = heap_new0(DynData);
    data->hmargin = 5;
    data->vmargin = 0;

    /* Alternative colors for Light and Dark themes */
    data->bgcolor[0] = gui_alt_color(color_rgb(255, 232, 232), color_rgb(128,
        ↪ 0, 0));
    data->bgcolor[1] = gui_alt_color(color_rgb(232, 255, 232), color_rgb(0,
        ↪ 128, 0));
    data->bgcolor[2] = gui_alt_color(color_rgb(232, 232, 255), color_rgb(0, 0,
        ↪ 128));
}

```

```

data->skcolor[0] = gui_alt_color(color_rgb(255, 85, 0), color_rgb(255,0, 0)
    ↪ );
data->skcolor[1] = gui_alt_color(color_rgb(5, 163, 0), color_rgb(0, 255, 0)
    ↪ );
data->skcolor[2] = gui_alt_color(color_rgb(109, 0, 163), color_rgb(0, 0,
    ↪ 255));
return data;
}

/*-----*/
/*
 * Dynamic layouts example
 *
 * The main layout is a stack with three rows:
 * Control Layout: Buttons to add/remove dynamic layouts cells
 * Top Layout: Grid layout with simple widgets where we can add/remove columns/
    ↪ rows dynamically
 * Bottom Layout: A stack where we can add/remove complex sublayouts dynamically
 *
 * Main layout lives in a scroll panel with fixed size.
 * When main layout grows, scrollbars will be activated to browse all the
    ↪ content.
 *
 */
/*-----*/
Panel *dynlay_panel(void)
{
    DynData *data = i_panel_data();
    Panel *panel = panel_scroll(TRUE, TRUE);
    Layout *layout = layout_create(1, 4);
    Layout *control_layout = i_control_layout(data);
    Layout *top_layout = i_top_layout(data);
    Layout *bottom_layout = i_bottom_layout(data);
    data->top_layout = top_layout;
    data->bottom_layout = bottom_layout;

    /* Main layout composition */
    layout_layout(layout, control_layout, 0, 0);
    layout_layout(layout, top_layout, 0, 1);
    layout_layout(layout, bottom_layout, 0, 2);

    /* Grid layout dynamic margins */
    i_top_layout_margins(data);

    /* Articles layout margins */
    i_bottom_layout_margins(data);

    /* Static vertical separation between three layouts */
    layout_vmargin(layout, 0, 10);
    layout_vmargin(layout, 1, 10);
}

```

```

/*
 * The main layout vertical expansion is delegated to a fourth empty cell.
 * This prevents excess pixels from being distributed across all rows,
 * keeping the top three rows together.
 */
layout_vexpand(layout, 3);

/*
 * Main container fixed size
 * Scrollbars will be activated when layouts grow
 */
panel_size(panel, s2df(400, 500));

/* Panel-Layout binding */
panel_layout(panel, layout);

/* DynData is a dynamic structure that will be destroyed the Panel destroys
   ↪ */
panel_data(panel, &data, i_destroy_dyndata, DynData);
return panel;
}

```

27.22. Hello IP-Input!

Figure 27.22: The `Edit` commands automatically change the keyboard focus after inserting the third character.

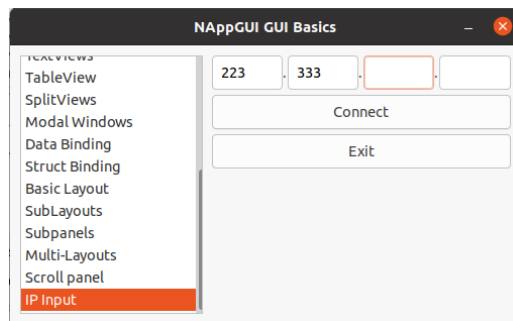

Listing 27.21: demo/guihello/ipinput.c

```

/* IP input */

#include "ipinput.h"
#include <gui/guiall.h>

/*-----*/

static void i_OnEditFilter(Window *window, Event* e)
{
    const EvText *p = event_params(e, EvText);
    EvTextFilter *filter = event_result(e, EvTextFilter);
    uint32_t i, j = 0, n = str_len_c(p->text);

```

```

/* We only accept numbers in IP controls */
for(i = 0; i < n; ++i)
{
    if (p->text[i] >= '0' && p->text[i] <= '9')
        filter->text[j++] = p->text[i];
}

if (j > 3)
    j = 3;

filter->text[j] = '\0';
filter->apply = TRUE;

/* We wrote the third character --> Jump to next control */
if (j == 3)
    window_next_tabstop(window);
}

/*-----*/

Panel *ip_input(Window *window)
{
    Panel *panel = panel_create();
    Layout *layout1 = layout_create(7, 1);
    Layout *layout2 = layout_create(1, 3);
    Label *label1 = label_create();
    Label *label2 = label_create();
    Label *label3 = label_create();
    Edit *edit1 = edit_create();
    Edit *edit2 = edit_create();
    Edit *edit3 = edit_create();
    Edit *edit4 = edit_create();
    Button *button1 = button_push();
    Button *button2 = button_push();
    label_text(label1, ".");
    label_text(label2, ".");
    label_text(label3, ".");
    button_text(button1, "Connect");
    button_text(button2, "Exit");
    edit_OnFilter(edit1, listener(window, i_OnEditFilter, Window));
    edit_OnFilter(edit2, listener(window, i_OnEditFilter, Window));
    edit_OnFilter(edit3, listener(window, i_OnEditFilter, Window));
    edit_OnFilter(edit4, listener(window, i_OnEditFilter, Window));
    layout_label(layout1, label1, 1, 0);
    layout_label(layout1, label2, 3, 0);
    layout_label(layout1, label3, 5, 0);
    layout_edit(layout1, edit1, 0, 0);
    layout_edit(layout1, edit2, 2, 0);
    layout_edit(layout1, edit3, 4, 0);
    layout_edit(layout1, edit4, 6, 0);
}

```

```
layout_layout(layout2, layout1, 0, 0);
layout_button(layout2, button1, 0, 1);
layout_button(layout2, button2, 0, 2);
layout_vmargin(layout2, 0, 5.f);
layout_vmargin(layout2, 1, 5.f);
layout_hsize(layout2, 0, 200.f);
panel_layout(panel, layout2);
return panel;
}
```

Hello Draw2d!

28.1 Hello Draw2d!

621

28.1. Hello Draw2d!

DrawHello is an application, which by example, shows the “*Draw2D*” (page 264) library features for 2D vector drawing. Implements line drawing, region fill, texts and images. The **source code** is in folder `/demo/drawhello` of the SDK distribution.

Listing 28.1: `demo/drawhello/drawhello.c`

```
/* Drawing primitives */

#include "res_drawhello.h"
#include <nappgui.h>

typedef struct _app_t App;

struct _app_t
{
    Window *window;
    View *view;
    Label *label;
    Cell *slider;
    uint32_t option;
    real32_t gradient;
};

/*-----*/

static void i_draw_lines(DCtx *ctx)
{
```

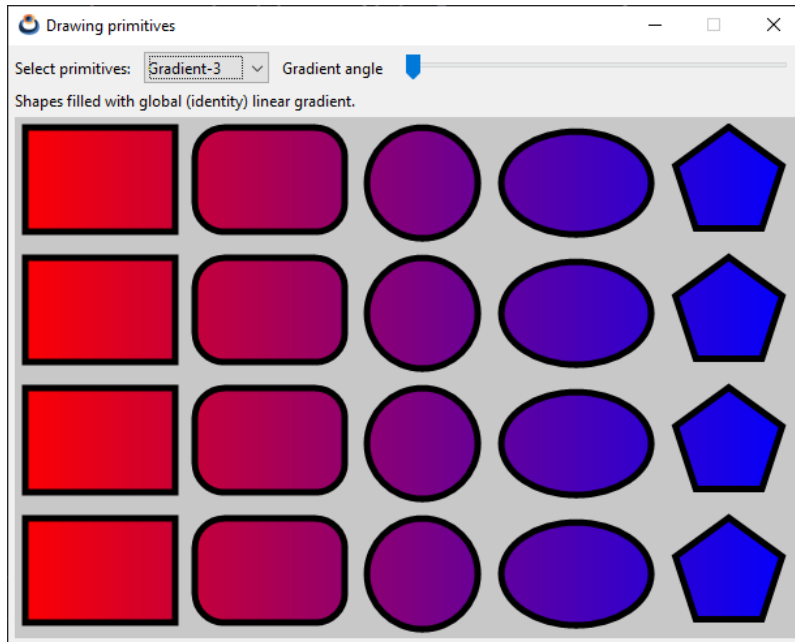

Figure 28.1: Windows version.

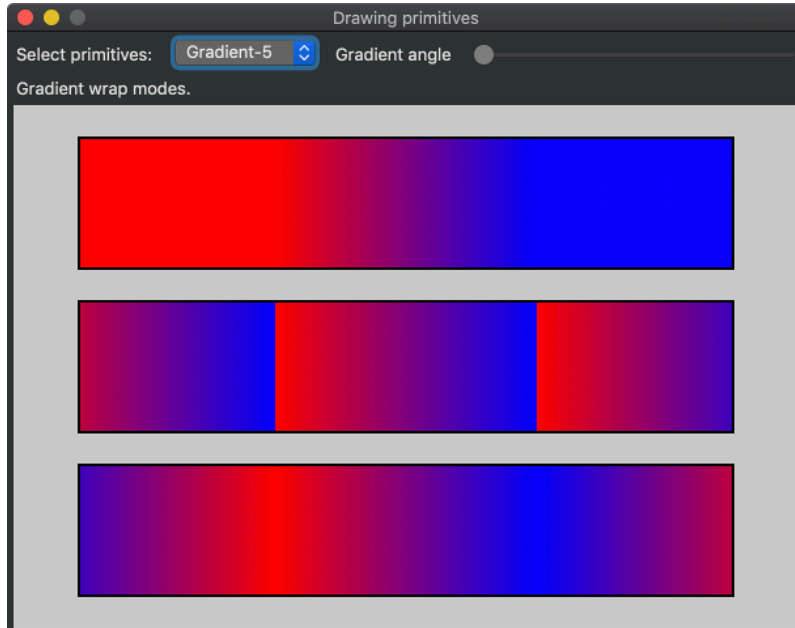

Figure 28.2: macOS version.

```
const V2Df poly1[] = { { 10, 190}, { 90, 110}, {110, 190}, {190, 110},
```

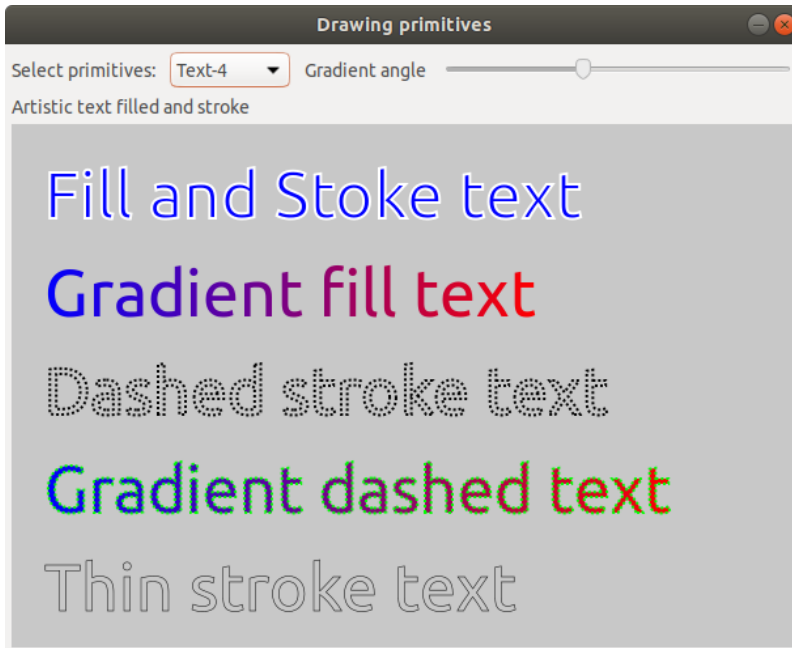

Figure 28.3: Linux version.

```

    ↪ {210, 190}, {290, 110} };
const V2Df poly2[] = { {310, 190}, {390, 110}, {410, 190}, {490, 110},
    ↪ {510, 190}, {590, 110} };
const V2Df poly3[] = { { 10, 290}, { 90, 210}, {110, 290}, {190, 210},
    ↪ {210, 290}, {290, 210} };
const real32_t pattern1[] = { 5, 5, 10, 5 };
const real32_t pattern2[] = { 1, 1 };
const real32_t pattern3[] = { 2, 1 };
const real32_t pattern4[] = { 1, 2 };

/* Line widths */
draw_line_color(ctx, kCOLOR_BLACK);
draw_line_width(ctx, 5);
draw_line(ctx, 10, 90, 90, 10);
draw_line_width(ctx, 10);
draw_line(ctx, 110, 90, 190, 10);
draw_line_width(ctx, 15);
draw_line(ctx, 210, 90, 290, 10);

/* Line caps */
draw_line_cap(ctx, ekLCFLAT);
draw_line(ctx, 310, 90, 390, 10);
draw_line_cap(ctx, ekLCSQUARE);
draw_line(ctx, 410, 90, 490, 10);
draw_line_cap(ctx, ekLCROUND);

```



```

draw_line(ctx, 510, 90, 590, 10);

/* Line joins */
draw_line_width(ctx, 15);
draw_line_cap(ctx, ekLCFLAT);
draw_line_join(ctx, ekLJMITER);
draw_polyline(ctx, FALSE, poly1, 6);
draw_line_cap(ctx, ekLCSQUARE);
draw_line_join(ctx, ekLJROUND);
draw_polyline(ctx, FALSE, poly2, 6);
draw_line_cap(ctx, ekLCROUND);
draw_line_join(ctx, ekLJBEVEL);
draw_polyline(ctx, FALSE, poly3, 6);

/* Line colors */
draw_line_width(ctx, 10);
draw_line_cap(ctx, ekLCFLAT);
draw_line_color(ctx, kCOLOR_RED);
draw_line(ctx, 310, 215, 590, 215);
draw_line_color(ctx, kCOLOR_GREEN);
draw_line(ctx, 310, 235, 590, 235);
draw_line_color(ctx, kCOLOR_BLUE);
draw_line(ctx, 310, 255, 590, 255);
draw_line_width(ctx, 5);
draw_line_color(ctx, kCOLOR_YELLOW);
draw_line(ctx, 310, 270, 590, 270);
draw_line_color(ctx, kCOLOR_CYAN);
draw_line(ctx, 310, 280, 590, 280);
draw_line_color(ctx, kCOLOR_MAGENTA);
draw_line(ctx, 310, 290, 590, 290);

/* Line patterns */
draw_line_color(ctx, kCOLOR_BLACK);
draw_line_width(ctx, 5);
draw_line_cap(ctx, ekLCFLAT);
draw_line_dash(ctx, pattern1, 4);
draw_line(ctx, 10, 310, 590, 310);
draw_line_dash(ctx, pattern2, 2);
draw_line(ctx, 10, 330, 590, 330);
draw_line_dash(ctx, pattern3, 2);
draw_line(ctx, 10, 350, 590, 350);
draw_line_dash(ctx, pattern4, 2);
draw_line_width(ctx, 2);
draw_line(ctx, 10, 365, 590, 365);
draw_line_dash(ctx, pattern1, 4);
draw_line_width(ctx, 1);
draw_line(ctx, 10, 375, 590, 375);
draw_line_dash(ctx, NULL, 0);
draw_line(ctx, 10, 385, 590, 385);

/* Thin lines in centers */

```

```

draw_line_dash(ctx, NULL, 0);
draw_line_color(ctx, color_rgb(255, 255, 255));
draw_line_width(ctx, 1);
draw_line(ctx, 10, 90, 90, 10);
draw_line(ctx, 110, 90, 190, 10);
draw_line(ctx, 210, 90, 290, 10);
draw_line(ctx, 310, 90, 390, 10);
draw_line(ctx, 410, 90, 490, 10);
draw_line(ctx, 510, 90, 590, 10);
draw_polyline(ctx, FALSE, poly1, 6);
draw_polyline(ctx, FALSE, poly2, 6);
draw_polyline(ctx, FALSE, poly3, 6);
}

/*-----*/

static void i_draw_shapes_row(DCtx *ctx, const drawop_t op, const T2Df *origin)
{
    const V2Df poly[] = { {40, 0}, {12.36f, 38.04f}, {-32.36f, 23.52f},
                          {-32.36f, -23.52f}, {12.36f, -38.04f} };

    T2Df matrix;
    draw_rect(ctx, op, 10, 10, 110, 75);
    draw_rndrect(ctx, op, 140, 10, 110, 75, 20);
    draw_circle(ctx, op, 312, 50, 40);
    draw_ellipse(ctx, op, 430, 50, 55, 37);
    t2d_movef(&matrix, origin, 547, 50);
    t2d_rotatef(&matrix, &matrix, - kBMATH_PIf / 10);
    draw_matrixf(ctx, &matrix);
    draw_polygon(ctx, op, poly, 5);
}

/*-----*/

static void i_draw_shapes(DCtx *ctx, const bool_t grad)
{
    T2Df origin = *kT2D_IDENTf;
    draw_line_color(ctx, kCOLOR_BLACK);
    draw_line_width(ctx, 10);
    draw_matrixf(ctx, &origin);
    i_draw_shapes_row(ctx, grad ? ekSKFILL : ekSTROKE, &origin);
    t2d_movef(&origin, &origin, 0, 100);
    draw_matrixf(ctx, &origin);
    i_draw_shapes_row(ctx, grad ? ekSKFILL : ekFILL, &origin);
    t2d_movef(&origin, &origin, 0, 100);
    draw_matrixf(ctx, &origin);
    i_draw_shapes_row(ctx, grad ? ekSKFILL : ekSKFILL, &origin);
    t2d_movef(&origin, &origin, 0, 100);
    draw_matrixf(ctx, &origin);
    i_draw_shapes_row(ctx, grad ? ekSKFILL : ekFILLSK, &origin);
}

```

```

/*-----*/
static void i_draw_gradient(DCtx *ctx, const real32_t gradient, const bool_t
    ↪ back, const bool_t shapes)
{
    color_t c[2];
    real32_t stop[2] = {0, 1};
    real32_t gpos;
    real32_t gx, gy;
    c[0] = kCOLOR_RED;
    c[1] = kCOLOR_BLUE;

    gpos = gradient * (600 + 400);

    if (gpos < 400)
    {
        gx = 600;
        gy = gpos;
    }
    else
    {
        gx = 600 - (gpos - 400);
        gy = 400;
    }

    draw_fill_linear(ctx, c, stop, 2, 0, 0, gx, gy);

    if (back == TRUE)
        draw_rect(ctx, ekFILL, 0, 0, 600, 400);

    if (shapes == TRUE)
        i_draw_shapes(ctx, TRUE);

    draw_matrixf(ctx, kt2D_IDENTf);
    draw_line_width(ctx, 3);
    draw_line_color(ctx, color_rgb(200, 200, 200));
    draw_line(ctx, 3, 3, gx + 3, gy + 3);
}

/*-----*/

static void i_draw_lines_gradient(DCtx *ctx, const real32_t gradient)
{
    color_t c[2];
    real32_t stop[2] = {0, 1};
    real32_t gpos;
    real32_t gx, gy;
    const real32_t pattern1[] = { 5, 5, 10, 5 };
    const real32_t pattern2[] = { 1, 1 };
    const real32_t pattern3[] = { 2, 1 };
    const real32_t pattern4[] = { 1, 2 };
}

```

```

c[0] = kCOLOR_RED;
c[1] = kCOLOR_BLUE;

gpos = gradient * (600 + 400);

if (gpos < 400)
{
    gx = 600;
    gy = gpos;
}
else
{
    gx = 600 - (gpos - 400);
    gy = 400;
}

draw_line_width(ctx, 10);
draw_line_fill(ctx);
draw_fill_linear(ctx, c, stop, 2, 0, 0, gx, gy);
i_draw_shapes_row(ctx, ekSTROKE, kt2D_IDENTf);

draw_matrixf(ctx, kt2D_IDENTf);
draw_line_width(ctx, 1);
draw_bezier(ctx, 30, 190, 140, 50, 440, 110, 570, 190);
draw_line_width(ctx, 4);
draw_bezier(ctx, 30, 210, 140, 70, 440, 130, 570, 210);
draw_line_width(ctx, 7);
draw_bezier(ctx, 30, 230, 140, 90, 440, 150, 570, 230);
draw_line_width(ctx, 10);
draw_bezier(ctx, 30, 250, 140, 110, 440, 170, 570, 250);

draw_line_width(ctx, 8);
draw_arc(ctx, 100, 280, 60, 0, - kBMATH_Pif / 2);
draw_arc(ctx, 250, 280, 60, kBMATH_Pif, kBMATH_Pif / 2);
draw_arc(ctx, 300, 220, 60, kBMATH_Pif / 2, - kBMATH_Pif / 2);
draw_arc(ctx, 450, 220, 60, kBMATH_Pif / 2, kBMATH_Pif / 2);

draw_line_width(ctx, 5);
draw_line_cap(ctx, ekLCFLAT);
draw_line_dash(ctx, pattern1, 4);
draw_line(ctx, 10, 310, 590, 310);
draw_line_dash(ctx, pattern2, 2);
draw_line(ctx, 10, 330, 590, 330);
draw_line_dash(ctx, pattern3, 2);
draw_line(ctx, 10, 350, 590, 350);
draw_line_dash(ctx, pattern4, 2);
draw_line_width(ctx, 2);
draw_line(ctx, 10, 365, 590, 365);
draw_line_dash(ctx, pattern1, 4);
draw_line_width(ctx, 1);

```

```

draw_line(ctx, 10, 375, 590, 375);
draw_line_dash(ctx, NULL, 0);
draw_line(ctx, 10, 385, 590, 385);

draw_line_width(ctx, 1);
draw_line_color(ctx, color_rgb(50, 50, 50));
draw_line(ctx, 3, 3, gx + 3, gy + 3);
}

/*-----*/

static void i_draw_local_gradient(DCtx *ctx, const real32_t gradient)
{
    color_t c[2];
    real32_t stop[2] = {0, 1};
    real32_t gpos;
    real32_t gx, gy;
    T2Df matrix;

    c[0] = kCOLOR_RED;
    c[1] = kCOLOR_BLUE;

    gpos = gradient * (200 + 100);

    if (gpos < 100)
    {
        gx = 200;
        gy = gpos;
    }
    else
    {
        gx = 200 - (gpos - 100);
        gy = 100;
    }

    draw_line_join(ctx, ekLJROUND);
    draw_fill_linear(ctx, c, stop, 2, 0, 0, gx, gy);

    t2d_movef(&matrix, kt2D_IDENTf, 50, 40);
    draw_matrixf(ctx, &matrix);
    draw_fill_matrix(ctx, &matrix);
    draw_line_width(ctx, 10);
    draw_line_color(ctx, kCOLOR_BLACK);
    draw_rect(ctx, ekSKFILL, 0, 0, 200, 100);
    draw_line_width(ctx, 3);
    draw_line_color(ctx, color_rgb(200, 200, 200));
    draw_line(ctx, 0, 0, gx, gy);

    t2d_movef(&matrix, kt2D_IDENTf, 400, 40);
    t2d_rotatef(&matrix, &matrix, kBMath_PI / 6);
    draw_matrixf(ctx, &matrix);

```

```

draw_fill_matrix(ctx, &matrix);
draw_line_width(ctx, 10);
draw_line_color(ctx, kCOLOR_BLACK);
draw_rect(ctx, ekSKFILL, 0, 0, 200, 100);
draw_line_width(ctx, 3);
draw_line_color(ctx, color_rgb(200, 200, 200));
draw_line(ctx, 0, 0, gx, gy);

t2d_movef(&matrix, kT2D_IDENTf, 250, 280);
t2d_rotatef(&matrix, &matrix, - kBMATH_PI f / 10);
draw_matrixf(ctx, &matrix);
t2d_movef(&matrix, &matrix, -100, -50);
draw_fill_matrix(ctx, &matrix);
draw_line_width(ctx, 10);
draw_line_color(ctx, kCOLOR_BLACK);
draw_ellipse(ctx, ekSKFILL, 0, 0, 100, 50);
draw_matrixf(ctx, &matrix);
draw_line_width(ctx, 3);
draw_line_color(ctx, color_rgb(200, 200, 200));
draw_line(ctx, 0, 0, gx, gy);
}

/*-----*/

static void i_draw_wrap_gradient(DCtx *ctx)
{
    color_t c[2];
    real32_t stop[2] = {0, 1};
    c[0] = kCOLOR_RED;
    c[1] = kCOLOR_BLUE;
    draw_line_width(ctx, 2);
    draw_fill_linear(ctx, c, stop, 2, 200, 0, 400, 0);
    draw_fill_wrap(ctx, ekFCLAMP);
    draw_rect(ctx, ekFILLSK, 50, 25, 500, 100);
    draw_fill_wrap(ctx, ekFTILE);
    draw_rect(ctx, ekFILLSK, 50, 150, 500, 100);
    draw_fill_wrap(ctx, ekFFLIP);
    draw_rect(ctx, ekFILLSK, 50, 275, 500, 100);
}

/*-----*/

static void i_text_single(DCtx *ctx)
{
    Font *font = font_system(20, 0);
    const char_t *text = "Text □□Κείμενο ";
    real32_t width, height;
    T2Df matrix;

    draw_font(ctx, font);
    draw_text_extents(ctx, text, -1, &width, &height);
}

```

```

draw_text_color(ctx, kCOLOR_BLUE);
draw_text_align(ctx, ekLEFT, ekTOP);
draw_text(ctx, text, 25, 25);
draw_text_align(ctx, ekCENTER, ekTOP);
draw_text(ctx, text, 300, 25);
draw_text_align(ctx, ekRIGHT, ekTOP);
draw_text(ctx, text, 575, 25);
draw_text_align(ctx, ekLEFT, ekCENTER);
draw_text(ctx, text, 25, 100);
draw_text_align(ctx, ekCENTER, ekCENTER);
draw_text(ctx, text, 300, 100);
draw_text_align(ctx, ekRIGHT, ekCENTER);
draw_text(ctx, text, 575, 100);
draw_text_align(ctx, ekLEFT, ekBOTTOM);
draw_text(ctx, text, 25, 175);
draw_text_align(ctx, ekCENTER, ekBOTTOM);
draw_text(ctx, text, 300, 175);
draw_text_align(ctx, ekRIGHT, ekBOTTOM);
draw_text(ctx, text, 575, 175);

draw_line_color(ctx, kCOLOR_RED);
draw_fill_color(ctx, kCOLOR_RED);
draw_circle(ctx, ekFILL, 25, 25, 3);
draw_circle(ctx, ekFILL, 300, 25, 3);
draw_circle(ctx, ekFILL, 575, 25, 3);
draw_circle(ctx, ekFILL, 25, 100, 3);
draw_circle(ctx, ekFILL, 300, 100, 3);
draw_circle(ctx, ekFILL, 575, 100, 3);
draw_circle(ctx, ekFILL, 25, 175, 3);
draw_circle(ctx, ekFILL, 300, 175, 3);
draw_circle(ctx, ekFILL, 575, 175, 3);
draw_circle(ctx, ekFILL, 25, 200, 3);
draw_circle(ctx, ekFILL, 300, 250, 3);
draw_circle(ctx, ekFILL, 25, 325, 3);
draw_circle(ctx, ekFILL, 575, 200, 3);
draw_circle(ctx, ekFILL, 575, 230, 3);
draw_circle(ctx, ekFILL, 575, 260, 3);
draw_rect(ctx, ekSTROKE, 25, 25, width, height);
draw_rect(ctx, ekSTROKE, 300 - (width / 2), 25, width, height);
draw_rect(ctx, ekSTROKE, 575 - width, 25, width, height);
draw_rect(ctx, ekSTROKE, 25, 100 - (height / 2), width, height);
draw_rect(ctx, ekSTROKE, 300 - (width / 2), 100 - (height / 2), width,
↪ height);
draw_rect(ctx, ekSTROKE, 575 - width, 100 - (height / 2), width, height);
draw_rect(ctx, ekSTROKE, 25, 175 - height, width, height);
draw_rect(ctx, ekSTROKE, 300 - (width / 2), 175 - height, width, height);
draw_rect(ctx, ekSTROKE, 575 - width, 175 - height, width, height);

draw_fill_color(ctx, kCOLOR_BLUE);
t2d_movef(&matrix, kT2D_IDENTf, 25, 200);
t2d_rotatef(&matrix, &matrix, kBMATH_PIF / 8);

```

```

draw_matrixf(ctx, &matrix);
draw_text_align(ctx, ekLEFT, ekTOP);
draw_text(ctx, text, 0, 0);

t2d_movef(&matrix, kT2D_IDENTf, 300, 250);
t2d_rotatef(&matrix, &matrix, - kBMATH_PIf / 8);
draw_matrixf(ctx, &matrix);
draw_text_align(ctx, ekCENTER, ekCENTER);
draw_text(ctx, text, 0, 0);

t2d_movef(&matrix, kT2D_IDENTf, 25, 325);
t2d_scalef(&matrix, &matrix, 3, 1);
draw_matrixf(ctx, &matrix);
draw_text_align(ctx, ekLEFT, ekTOP);
draw_text(ctx, text, 0, 0);

t2d_movef(&matrix, kT2D_IDENTf, 575, 200);
t2d_scalef(&matrix, &matrix, .5f, 1);
draw_matrixf(ctx, &matrix);
draw_text_align(ctx, ekRIGHT, ekTOP);
draw_text(ctx, text, 0, 0);

t2d_movef(&matrix, kT2D_IDENTf, 575, 230);
t2d_scalef(&matrix, &matrix, .75f, 1);
draw_matrixf(ctx, &matrix);
draw_text_align(ctx, ekRIGHT, ekTOP);
draw_text(ctx, text, 0, 0);

t2d_movef(&matrix, kT2D_IDENTf, 575, 260);
t2d_scalef(&matrix, &matrix, 1.25f, 1);
draw_matrixf(ctx, &matrix);
draw_text_align(ctx, ekRIGHT, ekTOP);
draw_text(ctx, text, 0, 0);

font_destroy(&font);
}

/*-----*/

static void i_text_newline(DCtx *ctx)
{
    Font *font = font_system(20, 0);
    const char_t *text = "Text new line\0000n\Γραμμή κειμένου";
    real32_t width, height;
    draw_font(ctx, font);
    draw_text_extents(ctx, text, -1, &width, &height);

    draw_text_color(ctx, kCOLOR_BLUE);
    draw_text_align(ctx, ekLEFT, ekTOP);
    draw_text_halign(ctx, ekLEFT);
    draw_text(ctx, text, 25, 25);
}

```



```

draw_text_align(ctx, ekCENTER, ekTOP);
draw_text_halign(ctx, ekCENTER);
draw_text(ctx, text, 300, 25);

draw_text_align(ctx, ekRIGHT, ekTOP);
draw_text_halign(ctx, ekRIGHT);
draw_text(ctx, text, 575, 25);
draw_text_align(ctx, ekLEFT, ekCENTER);
draw_text_halign(ctx, ekLEFT);
draw_text(ctx, text, 25, 175);
draw_text_align(ctx, ekCENTER, ekCENTER);
draw_text_halign(ctx, ekCENTER);
draw_text(ctx, text, 300, 175);
draw_text_align(ctx, ekRIGHT, ekCENTER);
draw_text_halign(ctx, ekRIGHT);
draw_text(ctx, text, 575, 175);
draw_text_align(ctx, ekLEFT, ekBOTTOM);
draw_text_halign(ctx, ekLEFT);
draw_text(ctx, text, 25, 325);
draw_text_align(ctx, ekCENTER, ekBOTTOM);
draw_text_halign(ctx, ekCENTER);
draw_text(ctx, text, 300, 325);
draw_text_align(ctx, ekRIGHT, ekBOTTOM);
draw_text_halign(ctx, ekRIGHT);
draw_text(ctx, text, 575, 325);

draw_line_color(ctx, kCOLOR_RED);
draw_fill_color(ctx, kCOLOR_RED);
draw_circle(ctx, ekFILL, 25, 25, 3);
draw_circle(ctx, ekFILL, 300, 25, 3);
draw_circle(ctx, ekFILL, 575, 25, 3);
draw_circle(ctx, ekFILL, 25, 175, 3);
draw_circle(ctx, ekFILL, 300, 175, 3);
draw_circle(ctx, ekFILL, 575, 175, 3);
draw_circle(ctx, ekFILL, 25, 325, 3);
draw_circle(ctx, ekFILL, 300, 325, 3);
draw_circle(ctx, ekFILL, 575, 325, 3);
draw_rect(ctx, ekSTROKE, 25, 25, width, height);
draw_rect(ctx, ekSTROKE, 300 - (width / 2), 25, width, height);
draw_rect(ctx, ekSTROKE, 575 - width, 25, width, height);
draw_rect(ctx, ekSTROKE, 25, 175 - (height / 2), width, height);
draw_rect(ctx, ekSTROKE, 300 - (width / 2), 175 - (height / 2), width,
↵ height);
draw_rect(ctx, ekSTROKE, 575 - width, 175 - (height / 2), width, height);
draw_rect(ctx, ekSTROKE, 25, 325 - height, width, height);
draw_rect(ctx, ekSTROKE, 300 - (width / 2), 325 - height, width, height);
draw_rect(ctx, ekSTROKE, 575 - width, 325 - height, width, height);
font_destroy(&font);
}
/*-----*/

```

```

static void i_text_block(DCtx *ctx)
{
    const char_t *text = "Lorem ipsum dolor sit amet, consectetur adipiscing
        ↳ elit, sed do eiusmod tempor incididunt ut labore et dolore magna
        ↳ aliqua. Ut enim ad minim veniam, quis nostrud exercitation ullamco
        ↳ laboris nisi ut aliquip ex ea commodo consequat.";
    real32_t dash[2] = {1, 1};
    real32_t width1, height1;
    real32_t width2, height2;
    real32_t width3, height3;
    real32_t width4, height4;

    draw_text_color(ctx, kCOLOR_BLUE);
    draw_text_align(ctx, ekLEFT, ekTOP);
    draw_text_halign(ctx, ekLEFT);
    draw_text_width(ctx, 200);
    draw_text_extents(ctx, text, 200, &width1, &height1);
    draw_text(ctx, text, 25, 25);
    draw_text_width(ctx, 300);
    draw_text_extents(ctx, text, 300, &width2, &height2);
    draw_text(ctx, text, 250, 25);
    draw_text_width(ctx, 400);
    draw_text_extents(ctx, text, 400, &width3, &height3);
    draw_text(ctx, text, 25, 200);
    draw_text_width(ctx, 500);
    draw_text_extents(ctx, text, 500, &width4, &height4);
    draw_text(ctx, text, 25, 315);

    draw_line_color(ctx, kCOLOR_RED);
    draw_fill_color(ctx, kCOLOR_RED);
    draw_circle(ctx, ekFILL, 25, 25, 3);
    draw_circle(ctx, ekFILL, 250, 25, 3);
    draw_circle(ctx, ekFILL, 25, 200, 3);
    draw_circle(ctx, ekFILL, 25, 315, 3);
    draw_rect(ctx, ekSTROKE, 25, 25, 200, height1);
    draw_rect(ctx, ekSTROKE, 250, 25, 300, height2);
    draw_rect(ctx, ekSTROKE, 25, 200, 400, height3);
    draw_rect(ctx, ekSTROKE, 25, 315, 500, height4);
    draw_line_dash(ctx, dash, 2);
    draw_rect(ctx, ekSTROKE, 25, 25, width1, height1);
    draw_rect(ctx, ekSTROKE, 250, 25, width2, height2);
    draw_rect(ctx, ekSTROKE, 25, 200, width3, height3);
    draw_rect(ctx, ekSTROKE, 25, 315, width4, height4);
}

/*-----*/

static void i_text_art(DCtx *ctx)
{
    Font *font = font_system(50, 0);

```

```

color_t c[2];
real32_t stop[2] = {0, 1};
real32_t dash[2] = {1, 1};
real32_t width, height;
c[0] = kCOLOR_BLUE;
c[1] = kCOLOR_RED;
draw_font(ctx, font);
draw_line_width(ctx, 2);
draw_line_color(ctx, kCOLOR_WHITE);
draw_fill_color(ctx, kCOLOR_BLUE);
draw_text_path(ctx, ekFILLSK, "Fill and Stoke text", 25, 25);
draw_text_extents(ctx, "Gradient fill text", -1, &width, &height);
draw_fill_linear(ctx, c, stop, 2, 25, 0, 25 + width, 0);
draw_fill_matrix(ctx, kT2D_IDENTf);
draw_text_path(ctx, ekFILL, "Gradient fill text", 25, 100);
draw_line_color(ctx, kCOLOR_BLACK);
draw_line_dash(ctx, dash, 2);
draw_text_path(ctx, ekSTROKE, "Dashed stroke text", 25, 175);
draw_line_color(ctx, kCOLOR_GREEN);
draw_text_extents(ctx, "Gradient dashed text", -1, &width, &height);
draw_fill_linear(ctx, c, stop, 2, 25, 0, 25 + width, 0);
draw_text_path(ctx, ekFILLSK, "Gradient dashed text", 25, 250);
draw_line_color(ctx, kCOLOR_BLACK);
draw_line_width(ctx, .5f);
draw_line_dash(ctx, NULL, 0);
draw_text_path(ctx, ekSTROKE, "Thin stroke text", 25, 325);
font_destroy(&font);
}

/*-----*/

static void i_image(DCtx *ctx)
{
    ResPack *pack = res_drawhello_repack("");
    const Image *image = image_from_resource(pack, IMAGE_PNG);
    T2Df matrix;

    draw_image_align(ctx, ekLEFT, ekTOP);
    draw_image(ctx, image, 25, 25);
    t2d_movef(&matrix, kT2D_IDENTf, 300, 200);
    t2d_rotatef(&matrix, &matrix, kBMath_Pi / 8);
    draw_image_align(ctx, ekCENTER, ekCENTER);
    draw_matrixf(ctx, &matrix);
    draw_image(ctx, image, 0, 0);
    draw_matrixf(ctx, kT2D_IDENTf);
    draw_image_align(ctx, ekRIGHT, ekTOP);
    draw_image(ctx, image, 575, 25);
    draw_image_align(ctx, ekLEFT, ekBOTTOM);
    draw_image(ctx, image, 25, 375);
    draw_image_align(ctx, ekRIGHT, ekBOTTOM);
    draw_image(ctx, image, 575, 375);
}

```

```

draw_fill_color(ctx, kCOLOR_BLUE);
draw_circle(ctx, ekFILL, 25, 25, 3);
draw_circle(ctx, ekFILL, 300, 200, 3);
draw_circle(ctx, ekFILL, 575, 25, 3);
draw_circle(ctx, ekFILL, 25, 375, 3);
draw_circle(ctx, ekFILL, 575, 375, 3);
respack_destroy(&pack);
}

/*-----*/

static void i_OnDraw(App *app, Event *e)
{
    const EvDraw *p = event_params(e, EvDraw);
    draw_clear(p->ctx, color_rgb(200, 200, 200));
    switch (app->option) {
    case 0:
        cell_enabled(app->slider, FALSE);
        label_text(app->label, "Different line styles: width, join, cap, dash
            ↪ ...");
        i_draw_lines(p->ctx);
        break;
    case 1:
        cell_enabled(app->slider, FALSE);
        label_text(app->label, "Basic shapes filled and stroke.");
        draw_fill_color(p->ctx, kCOLOR_BLUE);
        i_draw_shapes(p->ctx, FALSE);
        break;
    case 2:
        cell_enabled(app->slider, TRUE);
        label_text(app->label, "Global linear gradient.");
        i_draw_gradient(p->ctx, app->gradient, TRUE, FALSE);
        break;
    case 3:
        cell_enabled(app->slider, TRUE);
        label_text(app->label, "Shapes filled with global (identity) linear
            ↪ gradient.");
        i_draw_gradient(p->ctx, app->gradient, TRUE, TRUE);
        break;
    case 4:
        cell_enabled(app->slider, TRUE);
        label_text(app->label, "Shapes filled with global (identity) linear
            ↪ gradient.");
        i_draw_gradient(p->ctx, app->gradient, FALSE, TRUE);
        break;
    case 5:
        cell_enabled(app->slider, TRUE);
        label_text(app->label, "Lines with global (identity) linear gradient.");
        ↪ ;
        i_draw_lines_gradient(p->ctx, app->gradient);
    }
}

```

```

        break;
    case 6:
        cell_enabled(app->slider, TRUE);
        label_text(app->label, "Shapes filled with local (transformed) gradient
            ↪ .");
        i_draw_local_gradient(p->ctx, app->gradient);
        break;
    case 7:
        cell_enabled(app->slider, FALSE);
        label_text(app->label, "Gradient wrap modes.");
        i_draw_wrap_gradient(p->ctx);
        break;
    case 8:
        cell_enabled(app->slider, FALSE);
        label_text(app->label, "Single line text with alignment and transforms"
            ↪ );
        i_text_single(p->ctx);
        break;
    case 9:
        cell_enabled(app->slider, FALSE);
        label_text(app->label, "Text with newline '\\n' character and internal
            ↪ alignment");
        i_text_newline(p->ctx);
        break;
    case 10:
        cell_enabled(app->slider, FALSE);
        label_text(app->label, "Text block in a constrained width area");
        i_text_block(p->ctx);
        break;
    case 11:
        cell_enabled(app->slider, FALSE);
        label_text(app->label, "Artistic text filled and stroke");
        i_text_art(p->ctx);
        break;
    case 12:
        cell_enabled(app->slider, FALSE);
        label_text(app->label, "Drawing images with alignment");
        i_image(p->ctx);
        break;
    }
}

/*-----*/

static void i_OnAcceptFocus(App *app, Event *e)
{
    bool_t *r = event_result(e, bool_t);
    unref(app);
    *r = FALSE;
}

```

```

/*-----*/

static void i_OnSelect(App *app, Event *e)
{
    const EvButton *p = event_params(e, EvButton);
    app->option = p->index;
    view_update(app->view);
}

/*-----*/

static void i_OnSlider(App *app, Event *e)
{
    const EvSlider *p = event_params(e, EvSlider);
    app->gradient = p->pos;
    view_update(app->view);
}

/*-----*/

static Panel *i_panel(App *app)
{
    Panel *panel = panel_create();
    Layout *layout1 = layout_create(1, 3);
    Layout *layout2 = layout_create(4, 1);
    Label *label1 = label_create();
    Label *label2 = label_create();
    Label *label3 = label_multiline();
    PopUp *popup = popup_create();
    Slider *slider = slider_create();
    View *view = view_create();
    label_text(label1, "Select primitives:");
    label_text(label2, "Gradient angle");
    popup_add_elem(popup, "Lines", NULL);
    popup_add_elem(popup, "Shapes", NULL);
    popup_add_elem(popup, "Gradient-1", NULL);
    popup_add_elem(popup, "Gradient-2", NULL);
    popup_add_elem(popup, "Gradient-3", NULL);
    popup_add_elem(popup, "Gradient-4", NULL);
    popup_add_elem(popup, "Gradient-5", NULL);
    popup_add_elem(popup, "Gradient-6", NULL);
    popup_add_elem(popup, "Text-1", NULL);
    popup_add_elem(popup, "Text-2", NULL);
    popup_add_elem(popup, "Text-3", NULL);
    popup_add_elem(popup, "Text-4", NULL);
    popup_add_elem(popup, "Image", NULL);
    popup_list_height(popup, 6);
    popup_OnSelect(popup, listener(app, i_OnSelect, App));
    slider_OnMoved(slider, listener(app, i_OnSlider, App));
    view_size(view, s2df(600, 400));
    view_OnDraw(view, listener(app, i_OnDraw, App));
}

```

```

view_OnAcceptFocus(view, listener(app, i_OnAcceptFocus, App));
layout_label(layout2, label1, 0, 0);
layout_popup(layout2, popup, 1, 0);
layout_label(layout2, label2, 2, 0);
layout_slider(layout2, slider, 3, 0);
layout_layout(layout1, layout2, 0, 0);
layout_label(layout1, label3, 0, 1);
layout_view(layout1, view, 0, 2);
layout_margin(layout1, 5);
layout_hmargin(layout2, 0, 10);
layout_hmargin(layout2, 1, 10);
layout_hmargin(layout2, 2, 10);
layout_vmargin(layout1, 0, 5);
layout_vmargin(layout1, 1, 5);
layout_halign(layout1, 0, 1, ekJUSTIFY);
layout_hexpand(layout2, 3);
panel_layout(panel, layout1);
app->slider = layout_cell(layout2, 3, 0);
app->view = view;
app->label = label3;
return panel;
}

/*-----*/

static void i_OnClose(App *app, Event *e)
{
    osapp_finish();
    unref(app);
    unref(e);
}

/*-----*/

static App *i_create(void)
{
    App *app = heap_new0(App);
    Panel *panel = i_panel(app);
    app->window = window_create(ekWINDOW_STD);
    app->gradient = 0;
    app->option = 0;
    window_panel(app->window, panel);
    window_title(app->window, "Drawing primitives");
    window_origin(app->window, v2df(500, 200));
    window_OnClose(app->window, listener(app, i_OnClose, App));
    window_show(app->window);
    return app;
}

/*-----*/

```

```
static void i_destroy(App **app)
{
    window_destroy(&(*app)->window);
    heap_delete(app, App);
}
```

```
/*-----*/
```

```
#include "osmain.h"
osmain(i_create, i_destroy, "", App)
```

Hello WebView!

29.1 Hello WebView!

641

29.1. Hello WebView!

WebHello is a desktop application that integrates Web views along with other interface controls. The **source code** is in the `/demo/webhello` folder of the SDK distribution.



Figure 29.1: Windows version.

Listing 29.1: `demo/webhello/webhello.c`

```
/* WebView Hello World */  
  
#include <nappgui.h>
```

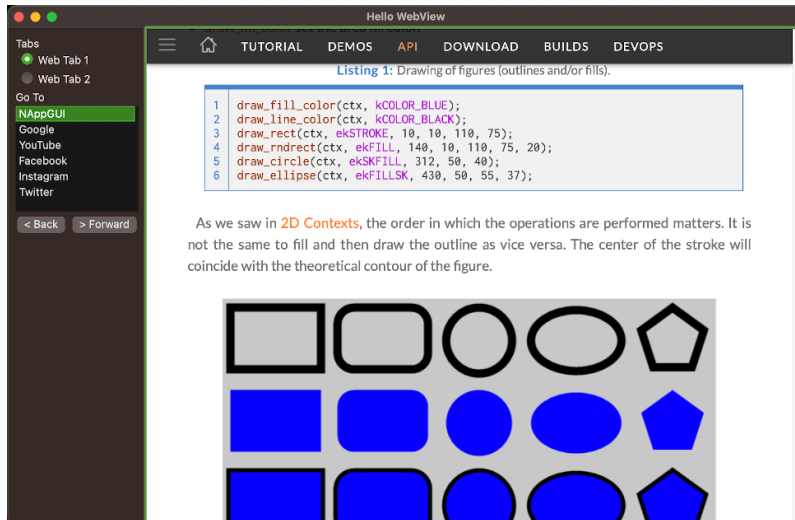

Figure 29.2: macOS version.

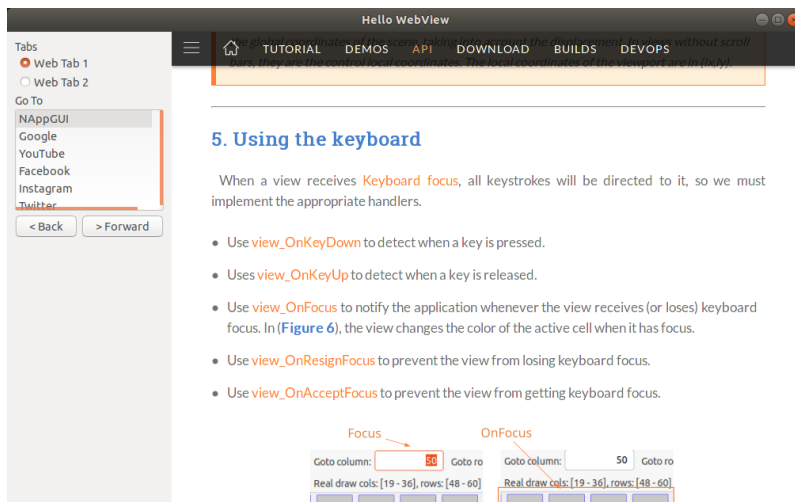

Figure 29.3: Linux version.

```
typedef struct _app_t App;

struct _app_t
{
    Window *window;
    Panel *tabpanel;
    uint32_t tabid;
    WebView *web1;
    WebView *web2;
};
```

```

};

/*-----*/

static void i_web_navigate(WebView *view, const uint32_t index)
{
    switch (index)
    {
        case 0:
            webview_navigate(view, "https://nappgui.com");
            break;
        case 1:
            webview_navigate(view, "https://google.com");
            break;
        case 2:
            webview_navigate(view, "https://youtube.com");
            break;
        case 3:
            webview_navigate(view, "https://facebook.com");
            break;
        case 4:
            webview_navigate(view, "https://instagram.com");
            break;
        case 5:
            webview_navigate(view, "https://twitter.com");
            break;
        cassert_default();
    }
}

/*-----*/

static void i_OnTab(App *app, Event *e)
{
    const EvButton *p = event_params(e, EvButton);
    panel_visible_layout(app->tabpanel, p->index);
    panel_update(app->tabpanel);
    app->tabid = p->index;
}

/*-----*/

static Layout *i_tabs_layout(App *app)
{
    Layout *layout = layout_create(1, 2);
    Button *button1 = button_radio();
    Button *button2 = button_radio();
    cassert_no_null(app);
    button_text(button1, "Web Tab 1");
    button_text(button2, "Web Tab 2");
    button_OnClick(button1, listener(app, i_OnTab, App));
}

```

```

    layout_button(layout, button1, 0, 0);
    layout_button(layout, button2, 0, 1);
    layout_margin4(layout, 0, 0, 0, 5);
    layout_vmargin(layout, 0, 5);
    button_state(app->tabid == 0 ? button1 : button2, ekGUI_ON);
    return layout;
}

/*-----*/

static void i_OnBack(App *app, Event *e)
{
    webview_back(app->tabid == 0 ? app->web1 : app->web2);
    unref(e);
}

/*-----*/

static void i_OnForward(App *app, Event *e)
{
    webview_forward(app->tabid == 0 ? app->web1 : app->web2);
    unref(e);
}

/*-----*/

static Layout *i_nav_layout(App *app)
{
    Layout *layout = layout_create(2, 1);
    Button *button1 = button_push();
    Button *button2 = button_push();
    button_text(button1, "< Back");
    button_text(button2, "> Forward");
    button_OnClick(button1, listener(app, i_OnBack, App));
    button_OnClick(button2, listener(app, i_OnForward, App));
    layout_button(layout, button1, 0, 0);
    layout_button(layout, button2, 1, 0);
    layout_hmargin(layout, 0, 5);
    unref(app);
    return layout;
}

/*-----*/

static void i_OnSelect(App *app, Event *e)
{
    const EvButton *p = event_params(e, EvButton);
    i_web_navigate(app->tabid == 0 ? app->web1 : app->web2, p->index);
}

/*-----*/

```

```

static Layout *i_control_layout(App *app)
{
    Layout *layout1 = layout_create(1, 5);
    Layout *layout2 = i_tabs_layout(app);
    Layout *layout3 = i_nav_layout(app);
    Label *label1 = label_create();
    Label *label2 = label_create();
    ListBox *list = listbox_create();
    label_text(label1, "Tabs");
    label_text(label2, "Go To");
    listbox_OnSelect(list, listener(app, i_OnSelect, App));
    listbox_add_elem(list, "NAppGUI", NULL);
    listbox_add_elem(list, "Google", NULL);
    listbox_add_elem(list, "YouTube", NULL);
    listbox_add_elem(list, "Facebook", NULL);
    listbox_add_elem(list, "Instagram", NULL);
    listbox_add_elem(list, "Twitter", NULL);
    listbox_select(list, 0, TRUE);
    layout_label(layout1, label1, 0, 0);
    layout_layout(layout1, layout2, 0, 1);
    layout_label(layout1, label2, 0, 2);
    layout_listbox(layout1, list, 0, 3);
    layout_layout(layout1, layout3, 0, 4);
    layout_vmargin(layout1, 0, 3);
    layout_vmargin(layout1, 1, 5);
    layout_vmargin(layout1, 2, 3);
    layout_vmargin(layout1, 3, 5);
    layout_margin(layout1, 10);
    return layout1;
}

/*-----*/

static Panel *i_tab_panel(App *app)
{
    Panel *panel = panel_create();
    Layout *layout1 = layout_create(1, 1);
    Layout *layout2 = layout_create(1, 1);
    WebView *view1 = webview_create();
    WebView *view2 = webview_create();
    cassert_no_null(app);
    webview_size(view1, s2df(800, 600));
    webview_size(view2, s2df(800, 600));
    i_web_navigate(view1, 0);
    i_web_navigate(view2, 1);
    layout_webview(layout1, view1, 0, 0);
    layout_webview(layout2, view2, 0, 0);
    panel_layout(panel, layout1);
    panel_layout(panel, layout2);
    app->tabpanel = panel;
}

```

```

    app->web1 = view1;
    app->web2 = view2;
    panel_visible_layout(panel, app->tabid);
    return panel;
}

/*-----*/

static Panel *i_panel(App *app)
{
    Panel *panel = panel_create();
    Layout *layout1 = layout_create(2, 1);
    Layout *layout2 = i_control_layout(app);
    Panel *tabpanel = i_tab_panel(app);
    layout_valign(layout1, 0, 0, ekTOP);
    layout_layout(layout1, layout2, 0, 0);
    layout_panel(layout1, tabpanel, 1, 0);
    layout_hexpand(layout1, 1);
    panel_layout(panel, layout1);
    return panel;
}

/*-----*/

static void i_OnClose(App *app, Event *e)
{
    osapp_finish();
    unref(app);
    unref(e);
}

/*-----*/

static App *i_app(void)
{
    App *app = heap_new0(App);
    app->tabid = 0;
    return app;
}

/*-----*/

static App *i_create(void)
{
    App *app = i_app();
    Panel *panel = i_panel(app);
    app->window = window_create(ekWINDOW_STDRES);
    window_panel(app->window, panel);
    window_title(app->window, "Hello WebView");
    window_origin(app->window, v2df(500, 200));
    window_OnClose(app->window, listener(app, i_OnClose, App));
}

```

```
    window_show(app->window);
    return app;
}

/*-----*/

static void i_destroy(App **app)
{
    window_destroy(&(*app)->window);
    heap_delete(app, App);
}

/*-----*/

#include "osmain.h"
osmain(i_create, i_destroy, "", App)
```

Hello 3D Graphics!

30.1 Hello 3D Graphics!

649

30.1. Hello 3D Graphics!

GLHello is a desktop application that integrates views with 3D graphics along with other interface controls. The **source code** is in the `/demo/glhello` folder of the SDK distribution.

Listing 30.1: `demo/glhello/glhello.c`

```
/* GLDemo Application */

#include "nappgui.h"
#include "glhello.h"
#include "res_glhello.h"

#include <ogl3d/ogl3d.h>
#include "ogl1.h"
#include "ogl2.h"
#include "ogl3.h"

typedef struct _app_t App;

struct _app_t
{
    Window *window;
    Panel *glpanel;
    View *glview;
    Label *errlabel;
    real32_t ptscale;
    OGL1 *ogl1;
};
```

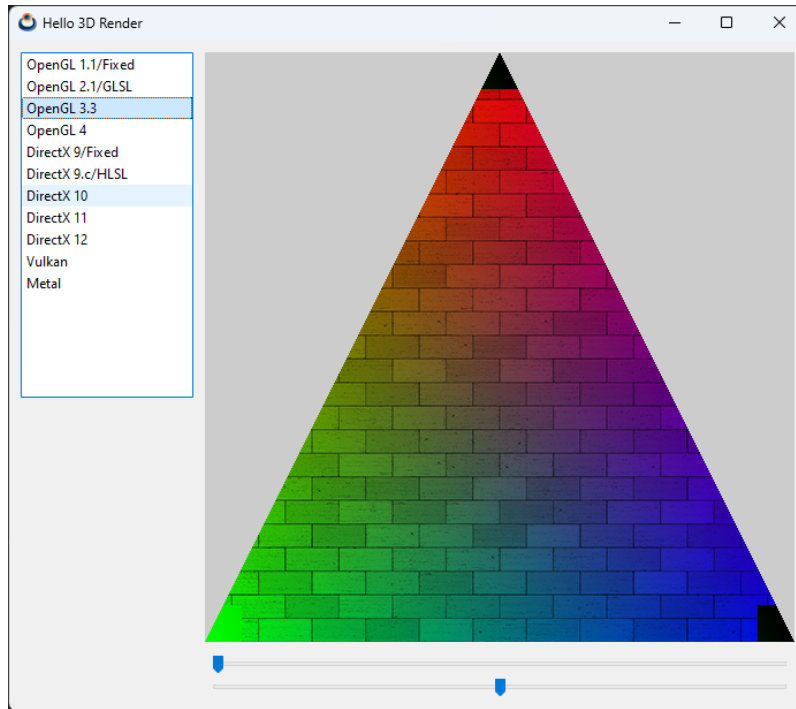

Figure 30.1: Windows version.

```

    OGL2 *ogl2;
    OGL3 *ogl3;
    uint32_t api;
    real32_t angle;
    real32_t scale;
    Pixbuf *texdata;
};

static App *APP = NULL;

/*-----*/

static void i_destroy_gl_apps(App *app)
{
    if (app->ogl1 != NULL)
        ogl1_destroy(&app->ogl1);

    if (app->ogl2 != NULL)
        ogl2_destroy(&app->ogl2);

    if (app->ogl3 != NULL)
        ogl3_destroy(&app->ogl3);
}

```

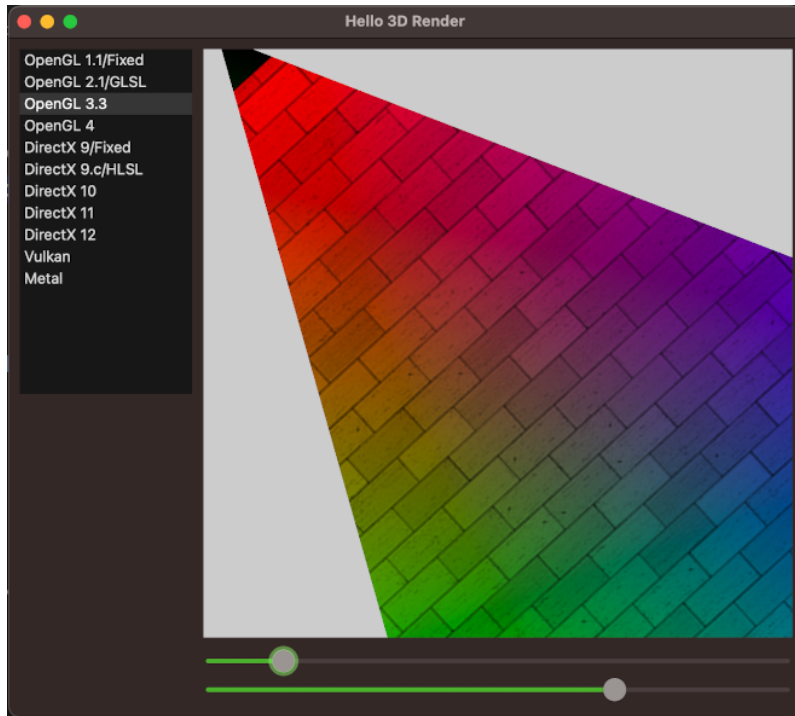

Figure 30.2: macOS version.

```

/*-----*/
static void i_set_glcontext(App *app, const uint32_t index)
{
    if (index != app->api)
    {
        String *err = NULL;

        app->api = index;
        i_destroy_gl_apps(app);

        switch (index)
        {
            case 0:
            {
                oglerr_t glerr;
                app->ogl1 = ogl1_create(app->glview, &glerr);
                if (app->ogl1 == NULL)
                    err = str_printf("Error creating OpenGL 1.1 context\n%s",
                                     ↪ ogl3d_err_str(glerr));
                break;
            }
        }
    }
}

```

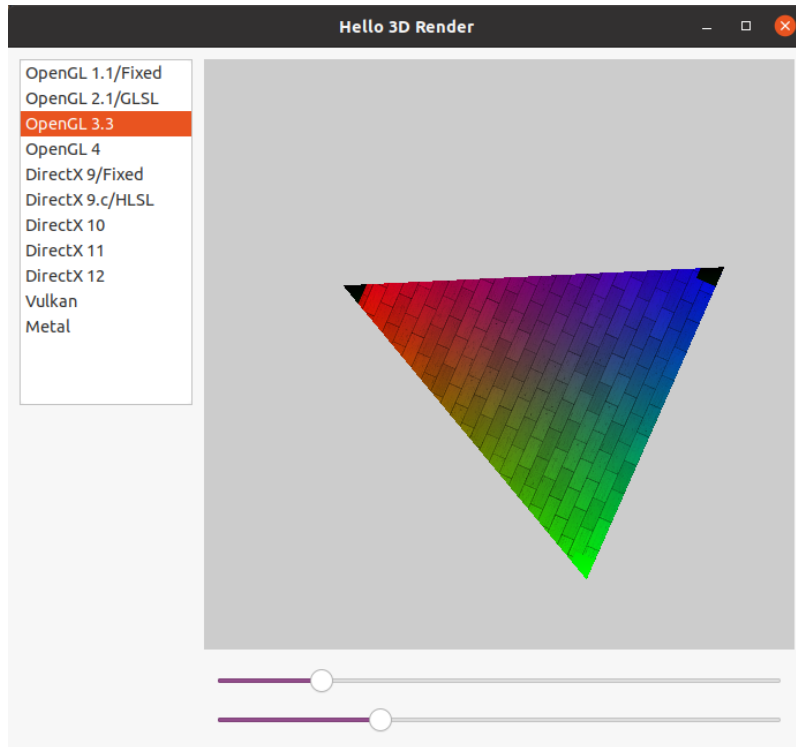

Figure 30.3: Linux version.

```

case 1:
{
    oglerr_t glerr;
    app->ogl2 = ogl2_create(app->glview, &glerr);
    if (app->ogl2 == NULL)
        err = str_printf("Error creating OpenGL 2.1 context\n%s",
            ↪ ogl3d_err_str(glerr));
    break;
}

case 2:
{
    oglerr_t glerr;
    app->ogl3 = ogl3_create(app->glview, &glerr);
    if (app->ogl3 == NULL)
        err = str_printf("Error creating OpenGL 3.3 context\n%s",
            ↪ ogl3d_err_str(glerr));
    break;
}

case 3:

```

```

err = str_printf("Error creating OpenGL 4.3 context\n%s", "Not
    ↪ available");
break;

case 4:
err = str_printf("Error creating DirectX 9 context\n%s", "Not
    ↪ available");
break;

case 5:
err = str_printf("Error creating DirectX 9.c context\n%s", "Not
    ↪ available");
break;

case 6:
err = str_printf("Error creating DirectX 10 context\n%s", "Not
    ↪ available");
break;

case 7:
err = str_printf("Error creating DirectX 11 context\n%s", "Not
    ↪ available");
break;

case 8:
err = str_printf("Error creating DirectX 12 context\n%s", "Not
    ↪ available");
break;

case 9:
err = str_printf("Error creating Vulkan context\n%s", "Not
    ↪ available");
break;

case 10:
err = str_printf("Error creating Metal context\n%s", "Not available
    ↪ ");
break;
}

if (err == NULL)
{
    panel_visible_layout(app->glpanel, 0);
}
else
{
    label_text(app->errlabel, tc(err));
    str_destroy(&err);
    panel_visible_layout(app->glpanel, 1);
}

```

```

        panel_update(app->glpanel);
        view_update(app->glview);
    }
}

/*-----*/

static void i_OnSelect(App *app, Event *e)
{
    const EvButton *p = event_params(e, EvButton);
    i_set_glcontext(app, p->index);
}

/*-----*/

static void i_OnDraw(App *app, Event *e)
{
    const EvDraw *p = event_params(e, EvDraw);
    /* Some displays (macOS Retina) have double-scaled pixels */
    real32_t width = p->width * app->ptscale;
    real32_t height = p->height * app->ptscale;
    switch (app->api)
    {
    case 0:
        ogl1_draw(app->ogl1, width, height, app->angle, app->scale);
        break;
    case 1:
        ogl2_draw(app->ogl2, width, height, app->angle, app->scale);
        break;
    case 2:
        ogl3_draw(app->ogl3, width, height, app->angle, app->scale);
        break;
    case 3:
        break;
    case 4:
        break;
    case 5:
        break;
    case 6:
        break;
    case 7:
        break;
    case 8:
        break;
    case 9:
        break;
    case 10:
        break;
    }
}

```

```

/*-----*/

static void i_OnSize(App *app, Event *e)
{
    const EvSize *p = event_params(e, EvSize);
    real32_t width = p->width * app->ptscale;
    real32_t height = p->height * app->ptscale;
    switch (app->api)
    {
    case 0:
        ogl1_resize(app->ogl1, width, height);
        break;
    case 1:
        ogl2_resize(app->ogl2, width, height);
        break;
    case 2:
        ogl3_resize(app->ogl3, width, height);
        break;
    case 3:
        break;
    case 4:
        break;
    case 5:
        break;
    case 6:
        break;
    case 7:
        break;
    case 8:
        break;
    case 9:
        break;
    case 10:
        break;
    }
}

/*-----*/

static void i_OnAngle(App *app, Event *e)
{
    const EvSlider *p = event_params(e, EvSlider);
    app->angle = p->pos;
    view_update(app->glview);
}

/*-----*/

static void i_OnScale(App *app, Event *e)
{
    const EvSlider *p = event_params(e, EvSlider);

```



```

    app->scale = 2 * p->pos;
    view_update(app->glview);
}

/*-----*/

static Panel *i_gl_panel(App *app)
{
    Panel *panel = panel_create();
    View *view = view_create();
    Label *label = label_multiline();
    Font *font = font_system(20, ekFNORMAL);
    Layout *layout1 = layout_create(1, 1);
    Layout *layout2 = layout_create(1, 1);
    view_size(view, s2df(512, 512));
    view_OnDraw(view, listener(app, i_OnDraw, App));
    view_OnSize(view, listener(app, i_OnSize, App));
    layout_view(layout1, view, 0, 0);
    label_font(label, font);
    label_align(label, ekCENTER);
    layout_label(layout2, label, 0, 0);
    layout_hsize(layout2, 0, 512);
    layout_vsize(layout2, 0, 512);
    layout_halign(layout2, 0, 0, ekCENTER);
    layout_valign(layout2, 0, 0, ekTOP);
    font_destroy(&font);
    panel_layout(panel, layout1);
    panel_layout(panel, layout2);
    app->errlabel = label;
    app->glpanel = panel;
    app->glview = view;
    view_point_scale(app->glview, &app->ptscale);
    return panel;
}

/*-----*/

static Layout *i_rlayout(App *app)
{
    Layout *layout = layout_create(1, 3);
    Panel *panel = i_gl_panel(app);
    Slider *slider1 = slider_create();
    Slider *slider2 = slider_create();
    slider_OnMoved(slider1, listener(app, i_OnAngle, App));
    slider_OnMoved(slider2, listener(app, i_OnScale, App));
    slider_value(slider2, .5f);
    layout_panel(layout, panel, 0, 0);
    layout_slider(layout, slider1, 0, 1);
    layout_slider(layout, slider2, 0, 2);
    layout_vmargIn(layout, 0, 10);
    layout_vexpand(layout, 0);
}

```

```

    return layout;
}

/*-----*/

static Panel *i_panel(App *app)
{
    Panel *panel = panel_create();
    Layout *layout1 = layout_create(2, 1);
    ListBox *listbox = listbox_create();
    Layout *layout2 = i_rlayout(app);
    listbox_add_elem(listbox, "OpenGL 1.1/Fixed", NULL);
    listbox_add_elem(listbox, "OpenGL 2.1/GLSL", NULL);
    listbox_add_elem(listbox, "OpenGL 3.3", NULL);
    listbox_add_elem(listbox, "OpenGL 4", NULL);
    listbox_add_elem(listbox, "DirectX 9/Fixed", NULL);
    listbox_add_elem(listbox, "DirectX 9.c/HLSL", NULL);
    listbox_add_elem(listbox, "DirectX 10", NULL);
    listbox_add_elem(listbox, "DirectX 11", NULL);
    listbox_add_elem(listbox, "DirectX 12", NULL);
    listbox_add_elem(listbox, "Vulkan", NULL);
    listbox_add_elem(listbox, "Metal", NULL);
    listbox_select(listbox, 0, TRUE);
    listbox_OnSelect(listbox, listener(app, i_OnSelect, App));
    listbox_size(listbox, s2df(150, 300));
    layout_listbox(layout1, listbox, 0, 0);
    layout_layout(layout1, layout2, 1, 0);
    panel_layout(panel, layout1);
    layout_valign(layout1, 0, 0, ekTOP);
    layout_hsize(layout1, 0, 150);
    layout_hexpand(layout1, 1);
    layout_margin(layout1, 10);
    layout_hmargin(layout1, 0, 10);
    return panel;
}

/*-----*/

static Window *i_window(App *app)
{
    Panel *panel = i_panel(app);
    Window *window = window_create(ekWINDOW_STDRES);
    window_panel(window, panel);
    window_title(window, "Hello 3D Render");
    i_set_glcontext(app, 0);
    return window;
}

/*-----*/

static void i_OnClose(App *app, Event *e)

```

```

{
    unref(app);
    unref(e);
    osapp_finish();
}

/*-----*/

static App *i_create(void)
{
    App *app = NULL;
    app = heap_new0(App);
    APP = app;
    ogl3d_start();
    app->api = UINT32_MAX;
    app->window = i_window(app);
    app->angle = 0;
    app->scale = 1;
    window_origin(app->window, v2df(500.f, 200.f));
    window_OnClose(app->window, listener(app, i_OnClose, App));
    window_show(app->window);
    return app;
}

/*-----*/

static void i_destroy(App **app)
{
    cassert_no_null(app);
    cassert_no_null(*app);

    i_destroy_gl_apps(*app);
    window_destroy(&(*app)->window);

    if ((*app)->texdata != NULL)
        pixbuf_destroy(&(*app)->texdata);

    ogl3d_finish();
    heap_delete(app, App);
}

/*-----*/

void glhello_texdata(const byte_t **texdata, uint32_t *texwidth, uint32_t *
    ↪ texheight, pixformat_t *texformat)
{
    if (APP->texdata == NULL)
    {
        ResPack *pack = res_glhello_respack("");
        APP->texdata = image_pixels(image_from_resource(pack, WALL_PNG),
            ↪ ekFIMAGE);
    }
}

```

```

        respack_destroy(&pack);
    }

    *texdata = pixbuf_data(APP->texdata);
    *texwidth = pixbuf_width(APP->texdata);
    *texheight = pixbuf_height(APP->texdata);
    *texformat = pixbuf_format(APP->texdata);
}

/*-----*/

#include "osmain.h"
osmain(i_create, i_destroy, "", App)

```

Listing 30.2: demo/glhello/ogl1.c

```

/* OpenGL 1 Demo */

#include "ogl1.h"
#include "glhello.h"
#include <ogl3d/ogl3d.h>
#include <sewer/cassert.h>
#include <core/heap.h>
#include <gui/view.h>

#include "nowarn.hxx"
#include <ogl3d/glew.h>
#include "warn.hxx"

struct _ogl1_t
{
    OGLCtx *ctx;
    GLboolean init;
    GLuint texture;
};

/*-----*/

OGL1 *ogl1_create(View *view, oglerr_t *err)
{
    void *nview = view_native(view);
    OGLCtx *ctx = NULL;
    OGLProps props;
    props.api = ekOGL_1_1;
    props.hdaccel = TRUE;
    props.color_bpp = 32;
    props.depth_bpp = 0;
    props.stencil_bpp = 0;
    props.aux_buffers = 0;
    props.transparent = FALSE;
    props.shared = NULL;
}

```

```

ctx = ogl3d_context(&props, nview, err);

if (ctx != NULL)
{
    OGL1 *ogl = heap_new0(OGL1);
    ogl->ctx = ctx;
    ogl->init = GL_FALSE;
    return ogl;
}

return NULL;
}

/*-----*/

void ogl1_destroy(OGL1 **ogl)
{
    cassert_no_null(ogl);
    cassert_no_null(*ogl);
    ogl3d_begin_draw((*ogl)->ctx);

    if ((*ogl)->init == GL_TRUE)
    {
        GLenum err;
        glBindTexture(GL_TEXTURE_2D, 0);
        glDeleteTextures(1, &(*ogl)->texture);
        cassert((err = glGetError()) == GL_NO_ERROR);
        unref(err);
    }

    ogl3d_end_draw((*ogl)->ctx);
    ogl3d_destroy(&(*ogl)->ctx);
    heap_delete(ogl, OGL1);
}

/*-----*/

/* Data to be stored in GPU memory */
static void i_device_data(OGL1 *ogl)
{
    const byte_t *texdata = NULL;
    uint32_t texwidth, texheight;
    pixformat_t texformat;
    glhello_texdata(&texdata, &texwidth, &texheight, &texformat);
    cassert(texformat == eRGB24);
    glGenTextures(1, &ogl->texture);
    cassert(glGetError() == GL_NO_ERROR);
    glBindTexture(GL_TEXTURE_2D, ogl->texture);
    glTexParameterf(GL_TEXTURE_2D, GL_TEXTURE_MAG_FILTER, GL_LINEAR);
    glTexParameterf(GL_TEXTURE_2D, GL_TEXTURE_MIN_FILTER, GL_LINEAR);
    glTexImage2D(GL_TEXTURE_2D, 0, GL_RGB, (GLsizei)texwidth, (GLsizei)

```

```

    ↪ texheight, 0, GL_RGB, GL_UNSIGNED_BYTE, (const void *)texdata);
    cassert(glGetError() == GL_NO_ERROR);
}

/*-----*/

void ogl1_draw(OpenGL *ogl, const real32_t width, const real32_t height, const
    ↪ real32_t angle, const real32_t scale)
{
    GLenum err;

    cassert_no_null(ogl);
    ogl3d_begin_draw(ogl->ctx);

    if (ogl->init == GL_FALSE)
    {
        i_device_data(ogl);
        ogl->init = GL_TRUE;
    }

    glViewport(0, 0, (GLsizei)width, (GLsizei)height);
    glClearColor(.8f, .8f, .8f, 1.0f);
    glClear(GL_COLOR_BUFFER_BIT);
    glMatrixMode(GL_MODELVIEW);
    glLoadIdentity();
    glScalef(scale, scale, 0);
    glRotatef(angle * 360, 0, 0, 1);
    glEnable(GL_TEXTURE_2D);
    glBindTexture(GL_TEXTURE_2D, ogl->texture);
    glTexEnvf(GL_TEXTURE_ENV, GL_TEXTURE_ENV_MODE, GL_MODULATE);
    /* Not in GL 1.1 */
    /* glTexEnvf(GL_TEXTURE_ENV, GL_SRC0_RGB, GL_PREVIOUS); */
    /* glTexEnvf(GL_TEXTURE_ENV, GL_SRC1_RGB, GL_TEXTURE); */
    cassert((err = glGetError()) == GL_NO_ERROR);

    glBegin(GL_TRIANGLES);
    glColor3f(1, 0, 0);
    glTexCoord2f(.5, 0);
    glVertex3f(0, 1, 0);
    glColor3f(0, 1, 0);
    glTexCoord2f(0, 1);
    glVertex3f(-1, -1, 0);
    glColor3f(0, 0, 1);
    glTexCoord2f(1, 1);
    glVertex3f(1, -1, 0);
    glEnd();
    unref(err);

    ogl3d_end_draw(ogl->ctx);
}

```

```

/*-----*/

void ogl1_resize(OpenGL *ogl, const real32_t width, const real32_t height)
{
    cassert_no_null(ogl);
    ogl3d_set_size(ogl->ctx, (uint32_t)width, (uint32_t)height);
}

```

Listing 30.3: demo/ghello/ogl2.c

```

/* OpenGL 2 Demo */

#include "ogl2.h"
#include "glhello.h"
#include <ogl3d/ogl3d.h>
#include <sewer/bmath.h>
#include <sewer/cassert.h>
#include <core/heap.h>
#include <gui/view.h>

#include "nowarn.hxx"
#include <ogl3d/glew.h>
#include "warn.hxx"

struct _ogl2_t
{
    OGLCtx *ctx;
    GLboolean init;
    GLuint texture;
    GLuint vbo;
    GLuint ibo;
    GLuint pshader;
    GLint pos_vertex;
    GLint col_vertex;
    GLint tex_vertex;
    GLint.mvp_uniform;
    GLint tex_uniform;
};

/*-----*/

static const GLchar *i_VS = "#version 120\n"
    "uniform mat4 uMVP;\n"
    "attribute vec3 vPos;\n"
    "attribute vec3 vColor;\n"
    "attribute vec2 vTex;\n"
    "varying vec3 outColor;\n"
    "varying vec2 texCoord;\n"
    "void main(void) {\n"
    "    gl_Position = uMVP * vec4(vPos.xyz, 1);\n"
    "    outColor = vColor;\n"

```

```

        texCoord = vTex;\n"
    "}\n ";

static const GLchar *i_FS = "#version 120\n"
    "varying vec3 outColor;\n"
    "varying vec2 texCoord;\n"
    "uniform sampler2D uTexture;\n"
    "void main (void) {\n"
    "    gl_FragColor = vec4(outColor.xyz, 1.0);\n"
    "    gl_FragColor *= texture2D(uTexture, texCoord)
    ↪ ;\n"
    "}\n";

/*-----*/

OGL2 *ogl2_create(View *view, oglerr_t *err)
{
    void *nview = view_native(view);
    OGLCtx *ctx = NULL;
    OGLProps props;
    props.api = ekOGL_2_1;
    props.hdaccel = TRUE;
    props.color_bpp = 32;
    props.depth_bpp = 0;
    props.stencil_bpp = 0;
    props.aux_buffers = 0;
    props.transparent = FALSE;
    props.shared = NULL;
    ctx = ogl3d_context(&props, nview, err);

    if (ctx != NULL)
    {
        OGL2 *ogl = heap_new0(OGL2);
        ogl->ctx = ctx;
        ogl->init = GL_FALSE;
        return ogl;
    }

    return NULL;
}

/*-----*/

void ogl2_destroy(OGL2 **ogl)
{
    cassert_no_null(ogl);
    cassert_no_null(*ogl);
    ogl3d_begin_draw((*ogl)->ctx);

    /* Delete all objects in device (GPU) space */
    if ((*ogl)->init == GL_TRUE)

```



```

{
    GLenum err;

    /* Unset all device objects */
    glBindTexture(GL_TEXTURE_2D, 0);
    glBindBuffer(GL_ARRAY_BUFFER, 0);
    glBindBuffer(GL_ELEMENT_ARRAY_BUFFER, 0);
    glUseProgram(0);

    /* Delete the texture */
    if ((*ogl)->texture != 0)
    {
        glDeleteTextures(1, &(*ogl)->texture);
        cassert((err = glGetError()) == GL_NO_ERROR);
        (*ogl)->texture = 0;
    }

    /* Delete the shader */
    if ((*ogl)->pshader != 0)
    {
        glDeleteProgram((*ogl)->pshader);
        cassert((err = glGetError()) == GL_NO_ERROR);
        (*ogl)->pshader = 0;
    }

    /* Delete the Vertex Buffer Object */
    if ((*ogl)->vbo != 0)
    {
        glDeleteBuffers(1, &(*ogl)->vbo);
        cassert((err = glGetError()) == GL_NO_ERROR);
        (*ogl)->vbo = 0;
    }

    /* Delete the Index(Element) Buffer Object */
    if ((*ogl)->ibo != 0)
    {
        glDeleteBuffers(1, &(*ogl)->ibo);
        cassert((err = glGetError()) == GL_NO_ERROR);
        (*ogl)->ibo = 0;
    }

    unref(err);
}

ogl3d_end_draw((*ogl)->ctx);
ogl3d_destroy(&(*ogl)->ctx);
heap_delete(ogl, OGL2);
}

/*-----*/

```

```

/* Data to be stored in GPU memory */
static void i_device_data(OpenGL *ogl)
{
    float vertices[] = {
        0, 1, 0, 1, 0, 0, .5f, 0, /* v0 pos, color, tex */
        -1, -1, 0, 0, 1, 0, 0, 1, /* v1 pos, color, tex */
        1, -1, 0, 0, 0, 1, 1, 1}; /* v2 pos, color, tex */
    uint32_t indices[] = {0, 1, 2};
    const byte_t *texdata;
    uint32_t texwidth, texheight;
    pixformat_t texformat;
    GLuint vshader;
    GLuint fshader;
    GLint status;
    GLenum err;
    char info[512];
    const char *version = cast_const(glGetString(GL_VERSION), char);
    const char *renderer = cast_const(glGetString(GL_RENDERER), char);
    unref(version);
    unref(renderer);

    /* Texture */
    glhello_texdata(&texdata, &texwidth, &texheight, &texformat);
    cassert(texformat == eRGB24);
    glGenTextures(1, &ogl->texture);
    cassert(glGetError() == GL_NO_ERROR);
    glBindTexture(GL_TEXTURE_2D, ogl->texture);
    glTexParameterf(GL_TEXTURE_2D, GL_TEXTURE_MAG_FILTER, GL_LINEAR);
    glTexParameterf(GL_TEXTURE_2D, GL_TEXTURE_MIN_FILTER, GL_LINEAR);
    glTexImage2D(GL_TEXTURE_2D, 0, GL_RGB, (GLsizei)texwidth, (GLsizei)
        ↪ texheight, 0, GL_RGB, GL_UNSIGNED_BYTE, (const void *)texdata);
    cassert(glGetError() == GL_NO_ERROR);

    /* Vertex Buffer Object */
    glGenBuffers(1, &ogl->vbo);
    glBindBuffer(GL_ARRAY_BUFFER, ogl->vbo);
    glBufferData(GL_ARRAY_BUFFER, sizeof(vertices), vertices, GL_STATIC_DRAW);

    /* Index Buffer */
    glGenBuffers(1, &ogl->ibo);
    glBindBuffer(GL_ELEMENT_ARRAY_BUFFER, ogl->ibo);
    glBufferData(GL_ELEMENT_ARRAY_BUFFER, sizeof(indices), indices,
        ↪ GL_STATIC_DRAW);

    /* Vertex Shader */
    vshader = glCreateShader(GL_VERTEX_SHADER);
    glShaderSource(vshader, 1, &i_VS, NULL);
    glCompileShader(vshader);
    glGetShaderiv(vshader, GL_COMPILE_STATUS, &status);
    glGetShaderInfoLog(vshader, 512, NULL, info);
    cassert(status != 0);
}

```

```

/* Pixel Shader */
fshader = glCreateShader(GL_FRAGMENT_SHADER);
glShaderSource(fshader, 1, &i_FS, NULL);
glCompileShader(fshader);
glGetShaderiv(fshader, GL_COMPILE_STATUS, &status);
glGetShaderInfoLog(fshader, 512, NULL, info);
cassert(status != 0);

/* Shader Program */
ogl->pshader = glCreateProgram();
glAttachShader(ogl->pshader, vshader);
glAttachShader(ogl->pshader, fshader);

/* The association between an attribute variable name and a generic
   ↪ attribute
   index can be specified at any time by calling glBindAttribLocation.
   Attribute bindings do not go into effect until glLinkProgram is called.
   After a program object has been linked successfully, the index values for
   attribute variables remain fixed until the next link command occurs.
   The attribute values can only be queried after a link if the link was
   successful. glGetAttribLocation returns the binding that actually went
   into effect the last time glLinkProgram was called for the specified
   program object. Attribute bindings that have been specified since the last
   link operation are not returned by glGetAttribLocation. */
glBindAttribLocation(ogl->pshader, 0, "vPos");
cassert((err = glGetError()) == GL_NO_ERROR);
glBindAttribLocation(ogl->pshader, 1, "vColor");
cassert((err = glGetError()) == GL_NO_ERROR);
glBindAttribLocation(ogl->pshader, 2, "vTex");
cassert((err = glGetError()) == GL_NO_ERROR);
glLinkProgram(ogl->pshader);
glGetProgramiv(ogl->pshader, GL_LINK_STATUS, &status);
glGetProgramInfoLog(ogl->pshader, 512, NULL, info);
cassert(status != 0);

/* Shader Parameters */
ogl->pos_vertex = glGetAttribLocation(ogl->pshader, "vPos");
cassert((err = glGetError()) == GL_NO_ERROR);
cassert(ogl->pos_vertex == 0);

ogl->col_vertex = glGetAttribLocation(ogl->pshader, "vColor");
cassert((err = glGetError()) == GL_NO_ERROR);
cassert(ogl->col_vertex == 1);

ogl->tex_vertex = glGetAttribLocation(ogl->pshader, "vTex");
cassert((err = glGetError()) == GL_NO_ERROR);
cassert(ogl->tex_vertex == 2);

ogl->mvp_uniform = glGetUniformLocation(ogl->pshader, "uMVP");
cassert((err = glGetError()) == GL_NO_ERROR);

```

```

ogl->tex_uniform = glGetUniformLocation(ogl->pshader, "uTexture");
cassert((err = glGetError()) == GL_NO_ERROR);

/* Delete vertex and pixel shared already linked */
glDeleteShader(vshader);
cassert((err = glGetError()) == GL_NO_ERROR);

glDeleteShader(fshader);
cassert((err = glGetError()) == GL_NO_ERROR);

unref(err);
}

/*-----*/

static void i_scale_rotate_Z(GLfloat *m, const real32_t a, const real32_t s)
{
    real32_t ca = bmath_cosf(a);
    real32_t sa = bmath_sinf(a);
    m[0] = s * ca;
    m[1] = s * sa;
    m[2] = 0;
    m[3] = 0;
    m[4] = -s * sa;
    m[5] = s * ca;
    m[6] = 0;
    m[7] = 0;
    m[8] = 0;
    m[9] = 0;
    m[10] = 1;
    m[11] = 0;
    m[12] = 0;
    m[13] = 0;
    m[14] = 0;
    m[15] = 1;
}

/*-----*/

void ogl2_draw(OpenGL *ogl, const real32_t width, const real32_t height, const
↪ real32_t angle, const real32_t scale)
{
    GLfloat m[16];
    GLenum err;

    cassert_no_null(ogl);
    ogl3d_begin_draw(ogl->ctx);

    if (ogl->init == GL_FALSE)
    {

```

```

    i_device_data(ogl);
    ogl->init = GL_TRUE;
}

glViewport(0, 0, (GLsizei)width, (GLsizei)height);
glClearColor(.8f, .8f, 0.8f, 1.0f);
glClear(GL_COLOR_BUFFER_BIT);

/* Set the texture */
glActiveTexture(GL_TEXTURE0);
glEnable(GL_TEXTURE_2D);
glBindTexture(GL_TEXTURE_2D, ogl->texture);
cassert((err = glGetError()) == GL_NO_ERROR);

/* Set vertex buffer */
glBindBuffer(GL_ARRAY_BUFFER, ogl->vbo);
cassert((err = glGetError()) == GL_NO_ERROR);

/* Set index buffer */
glBindBuffer(GL_ELEMENT_ARRAY_BUFFER, ogl->ibo);
cassert((err = glGetError()) == GL_NO_ERROR);

/* Enable vertex attributes */
glVertexAttribPointer((GLuint)ogl->pos_vertex, 3, GL_FLOAT, GL_FALSE, 8 *
    ↪ sizeof(float), (void *)0);
cassert((err = glGetError()) == GL_NO_ERROR);
glEnableVertexAttribArray((GLuint)ogl->pos_vertex);
cassert((err = glGetError()) == GL_NO_ERROR);
glVertexAttribPointer((GLuint)ogl->col_vertex, 3, GL_FLOAT, GL_FALSE, 8 *
    ↪ sizeof(float), (void *) (3 * sizeof(float)));
cassert((err = glGetError()) == GL_NO_ERROR);
glEnableVertexAttribArray((GLuint)ogl->col_vertex);
cassert((err = glGetError()) == GL_NO_ERROR);
glVertexAttribPointer((GLuint)ogl->tex_vertex, 2, GL_FLOAT, GL_FALSE, 8 *
    ↪ sizeof(float), (void *) (6 * sizeof(float)));
cassert((err = glGetError()) == GL_NO_ERROR);
glEnableVertexAttribArray((GLuint)ogl->tex_vertex);
cassert((err = glGetError()) == GL_NO_ERROR);

/* Set the shader */
glUseProgram(ogl->pshader);
cassert((err = glGetError()) == GL_NO_ERROR);

/* Model-View-Projection and draw */
i_scale_rotate_Z(m, angle * 2 * kBMATH_PIf, scale);
glUniformMatrix4fv(ogl->mvp_uniform, 1, GL_FALSE, m);
glDrawElements(GL_TRIANGLES, 3, GL_UNSIGNED_INT, 0);
cassert((err = glGetError()) == GL_NO_ERROR);

ogl3d_end_draw(ogl->ctx);
}

```

```

/*-----*/

void ogl2_resize(OpenGL *ogl, const real32_t width, const real32_t height)
{
    cassert_no_null(ogl);
    ogl3d_set_size(ogl->ctx, (uint32_t)width, (uint32_t)height);
}

```

Listing 30.4: demo/ghello/ogl3.c

```

/* OpenGL 3 Demo */

#include "ogl3.h"
#include "glhello.h"
#include <ogl3d/ogl3d.h>
#include <sewer/bmath.h>
#include <sewer/cassert.h>
#include <core/heap.h>
#include <gui/view.h>

#include "nowarn.hxx"
#include <ogl3d/glew.h>
#include "warn.hxx"

struct _ogl3_t
{
    OGLCtx *ctx;
    GLboolean init;
    GLuint texture;
    GLuint vbo;
    GLuint vao;
    GLuint ibo;
    GLuint pshader;
    GLint.mvp_uniform;
    GLint.tex_uniform;
};

/*-----*/

static const GLchar *i_VS = "#version 330\n"
    "uniform mat4 uMVP;\n"
    "layout(location = 0) in vec3 vPos;\n"
    "layout(location = 1) in vec3 vColor;\n"
    "layout(location = 2) in vec2 vTex;\n"
    "out vec3 outColor;\n"
    "out vec2 texCoord;\n"
    "void main(void) {\n"
    "    gl_Position = uMVP * vec4(vPos.xyz, 1);\n"
    "    outColor = vColor;\n"
    "    texCoord = vTex;\n"

```

```

        "}\n";

static const char_t *i_FS = "#version 330\n"
    "in vec3 outColor;\n"
    "in vec2 texCoord;\n"
    "out vec4 fragColor;\n"
    "uniform sampler2D uTexture;\n"
    "void main (void) {\n"
    "    fragColor = vec4(outColor.xyz, 1.0);\n"
    "    fragColor *= texture(uTexture, texCoord);\n"
    "}\n";

/*-----*/

OGL3 *ogl3_create(View *view, oglerr_t *err)
{
    void *nview = view_native(view);
    OGLCtx *ctx = NULL;
    OGLProps props;
    props.api = ekOGL_3_3;
    props.hdaccel = TRUE;
    props.color_bpp = 32;
    props.depth_bpp = 0;
    props.stencil_bpp = 0;
    props.aux_buffers = 0;
    props.transparent = FALSE;
    props.shared = NULL;
    ctx = ogl3d_context(&props, nview, err);

    if (ctx != NULL)
    {
        OGL3 *ogl = heap_new0(OGL3);
        ogl->ctx = ctx;
        ogl->init = GL_FALSE;
        return ogl;
    }

    return NULL;
}

/*-----*/

void ogl3_destroy(OGL3 **ogl)
{
    cassert_no_null(ogl);
    cassert_no_null(*ogl);
    ogl3d_begin_draw((*ogl)->ctx);

    /* Delete all objects in device (GPU) space */
    if ((*ogl)->init == GL_TRUE)
    {

```

```

GLenum err;

/* Unset all device objects */
glBindTexture(GL_TEXTURE_2D, 0);
glBindBuffer(GL_ARRAY_BUFFER, 0);
glBindBuffer(GL_ELEMENT_ARRAY_BUFFER, 0);
glBindVertexArray(0);
glUseProgram(0);

/* Delete the texture */
if ((*ogl)->texture != 0)
{
    glDeleteTextures(1, &(*ogl)->texture);
    cassert((err = glGetError()) == GL_NO_ERROR);
    (*ogl)->texture = 0;
}

/* Delete the shader */
if ((*ogl)->pshader != 0)
{
    glDeleteProgram((*ogl)->pshader);
    cassert((err = glGetError()) == GL_NO_ERROR);
    (*ogl)->pshader = 0;
}

/* Delete the Vertex Buffer Object */
if ((*ogl)->vbo != 0)
{
    glDeleteBuffers(1, &(*ogl)->vbo);
    cassert((err = glGetError()) == GL_NO_ERROR);
    (*ogl)->vbo = 0;
}

/* Delete the Vertex Array Object */
if ((*ogl)->vao != 0)
{
    glDeleteVertexArrays(1, &(*ogl)->vao);
    cassert((err = glGetError()) == GL_NO_ERROR);
    (*ogl)->vao = 0;
}

/* Delete the Index(Element) Buffer Object */
if ((*ogl)->ibo != 0)
{
    glDeleteBuffers(1, &(*ogl)->ibo);
    cassert((err = glGetError()) == GL_NO_ERROR);
    (*ogl)->ibo = 0;
}

unref(err);
}

```



```

    ogl3d_end_draw((*ogl)->ctx);
    ogl3d_destroy(&(*ogl)->ctx);
    heap_delete(ogl, OGL3);
}

/*-----*/

/* Data to be stored in GPU memory */
static void i_device_data(OGL3 *ogl)
{
    const float vertices[] = {
        0, 1, 0, 1, 0, 0, .5f, 0, /* v0 pos, color, tex */
        -1, -1, 0, 0, 1, 0, 0, 1, /* v1 pos, color, tex */
        1, -1, 0, 0, 0, 1, 1, 1}; /* v2 pos, color, tex */
    uint32_t indices[] = {0, 1, 2};
    const byte_t *texdata = NULL;
    uint32_t texwidth, texheight;
    pixformat_t texformat;
    GLuint vshader;
    GLuint fshader;
    GLint status;
    GLenum err;
    char info[512];
    const char *version = cast_const(glGetString(GL_VERSION), char);
    const char *renderer = cast_const(glGetString(GL_RENDERER), char);
    unref(version);
    unref(renderer);

    /* Texture */
    glhello_texdata(&texdata, &texwidth, &texheight, &texformat);
    cassert(texformat == e_kRGB24);
    glGenTextures(1, &ogl->texture);
    cassert(glGetError() == GL_NO_ERROR);
    glBindTexture(GL_TEXTURE_2D, ogl->texture);
    glTexParameteri(GL_TEXTURE_2D, GL_TEXTURE_MAG_FILTER, GL_LINEAR);
    glTexParameteri(GL_TEXTURE_2D, GL_TEXTURE_MIN_FILTER, GL_LINEAR);
    glTexImage2D(GL_TEXTURE_2D, 0, GL_RGB, (GLsizei)texwidth, (GLsizei)
        ↪ texheight, 0, GL_RGB, GL_UNSIGNED_BYTE, cast_const(texdata, void));
    cassert(glGetError() == GL_NO_ERROR);

    /* Vertex Array Object */
    glGenVertexArrays(1, &ogl->vao);
    glBindVertexArray(ogl->vao);
    cassert((err = glGetError()) == GL_NO_ERROR);

    /* Vertex Buffer Object */
    glGenBuffers(1, &ogl->vbo);
    glBindBuffer(GL_ARRAY_BUFFER, ogl->vbo);
    glBufferData(GL_ARRAY_BUFFER, sizeof(vertices), vertices, GL_STATIC_DRAW);
    cassert((err = glGetError()) == GL_NO_ERROR);
}

```

```

/* Enable vertex attributes */
/* 0 = layout(location = 0) vPos */
glVertexAttribPointer(0 /* vPos */, 3, GL_FLOAT, GL_FALSE, 8 * sizeof(float
↪ ), (void *)0);
cassert((err = glGetError()) == GL_NO_ERROR);
glEnableVertexAttribArray(0 /* vPos */);
cassert((err = glGetError()) == GL_NO_ERROR);
/* 1 = layout(location = 1) vColor */
glVertexAttribPointer(1 /* vColor */, 3, GL_FLOAT, GL_FALSE, 8 * sizeof(
↪ float), (void *) (3 * sizeof(float)));
cassert((err = glGetError()) == GL_NO_ERROR);
glEnableVertexAttribArray(1 /* vColor */);
cassert((err = glGetError()) == GL_NO_ERROR);
/* 2 = layout(location = 2) vTex */
glVertexAttribPointer(2 /* vTex */, 2, GL_FLOAT, GL_FALSE, 8 * sizeof(float
↪ ), (void *) (6 * sizeof(float)));
cassert((err = glGetError()) == GL_NO_ERROR);
glEnableVertexAttribArray(2 /* vTex */);
cassert((err = glGetError()) == GL_NO_ERROR);

/* Index Buffer */
glGenBuffers(1, &ogl->ibo);
glBindBuffer(GL_ELEMENT_ARRAY_BUFFER, ogl->ibo);
glBufferData(GL_ELEMENT_ARRAY_BUFFER, sizeof(indices), indices,
↪ GL_STATIC_DRAW);
cassert((err = glGetError()) == GL_NO_ERROR);

/* Vertex Shader */
vshader = glCreateShader(GL_VERTEX_SHADER);
glShaderSource(vshader, 1, &i_VS, NULL);
glCompileShader(vshader);
glGetShaderiv(vshader, GL_COMPILE_STATUS, &status);
glGetShaderInfoLog(vshader, 512, NULL, info);
cassert(status != 0);

/* Pixel Shader */
fshader = glCreateShader(GL_FRAGMENT_SHADER);
glShaderSource(fshader, 1, &i_FS, NULL);
glCompileShader(fshader);
glGetShaderiv(fshader, GL_COMPILE_STATUS, &status);
glGetShaderInfoLog(fshader, 512, NULL, info);
cassert(status != 0);

/* Shader Program */
ogl->pshader = glCreateProgram();
glAttachShader(ogl->pshader, vshader);
glAttachShader(ogl->pshader, fshader);
glLinkProgram(ogl->pshader);
glGetProgramiv(ogl->pshader, GL_LINK_STATUS, &status);
glGetProgramInfoLog(ogl->pshader, 512, NULL, info);

```

```

    cassert(status != 0);

    /* Shader uniform access */
    ogl->mvp_uniform = glGetUniformLocation(ogl->pshader, "uMVP");
    cassert((err = glGetError()) == GL_NO_ERROR);

    ogl->tex_uniform = glGetUniformLocation(ogl->pshader, "uTexture");
    cassert((err = glGetError()) == GL_NO_ERROR);

    /* Delete vertex and pixel shared already linked */
    glDeleteShader(vshader);
    cassert((err = glGetError()) == GL_NO_ERROR);

    glDeleteShader(fshader);
    cassert((err = glGetError()) == GL_NO_ERROR);

    unref(err);
}

/*-----*/

static void i_scale_rotate_Z(GLfloat *m, const real32_t a, const real32_t s)
{
    real32_t ca = bmath_cosf(a);
    real32_t sa = bmath_sinf(a);
    m[0] = s * ca;
    m[1] = s * sa;
    m[2] = 0;
    m[3] = 0;
    m[4] = -s * sa;
    m[5] = s * ca;
    m[6] = 0;
    m[7] = 0;
    m[8] = 0;
    m[9] = 0;
    m[10] = 1;
    m[11] = 0;
    m[12] = 0;
    m[13] = 0;
    m[14] = 0;
    m[15] = 1;
}

/*-----*/

void ogl3_draw(OpenGL *ogl, const real32_t width, const real32_t height, const
↪ real32_t angle, const real32_t scale)
{
    GLfloat m[16];
    GLenum err;

```

```

cassert_no_null(ogl);
ogl3d_begin_draw(ogl->ctx);

if (ogl->init == GL_FALSE)
{
    i_device_data(ogl);
    ogl->init = GL_TRUE;
}

glViewport(0, 0, (GLsizei)width, (GLsizei)height);
glClearColor(.8f, .8f, 0.8f, 1.0f);
glClear(GL_COLOR_BUFFER_BIT);

/* Set the texture */
glActiveTexture(GL_TEXTURE0);
glBindTexture(GL_TEXTURE_2D, ogl->texture);
cassert((err = glGetError()) == GL_NO_ERROR);

/* Set vertex array object */
glBindVertexArray(ogl->vao);
cassert((err = glGetError()) == GL_NO_ERROR);

/* Set index buffer object */
glBindBuffer(GL_ELEMENT_ARRAY_BUFFER, ogl->ibo);
cassert((err = glGetError()) == GL_NO_ERROR);

/* Set the shader */
glUseProgram(ogl->pshader);
cassert((err = glGetError()) == GL_NO_ERROR);

/* Model-View-Projection and draw */
i_scale_rotate_Z(m, angle * 2 * kBMATH_PI, scale);
glUniformMatrix4fv(ogl->mvp_uniform, 1, GL_FALSE, m);
glDrawElements(GL_TRIANGLES, 3, GL_UNSIGNED_INT, 0);
cassert((err = glGetError()) == GL_NO_ERROR);

ogl3d_end_draw(ogl->ctx);
}

/*-----*/

void ogl3_resize(OpenGL *ogl, const real32_t width, const real32_t height)
{
    cassert_no_null(ogl);
    ogl3d_set_size(ogl->ctx, (uint32_t)width, (uint32_t)height);
}

```

Hello 2D Collisions!

31.1 Hello 2D Collisions!

677

31.1. Hello 2D Collisions!

Col2dHello is a small environment for experimentation with 2D collision detection algorithms. It allows you to create different types of volumes, move them with the mouse and edit them through the side panel. The details of the functions can be found in “*2D Collisions*” (page 261).

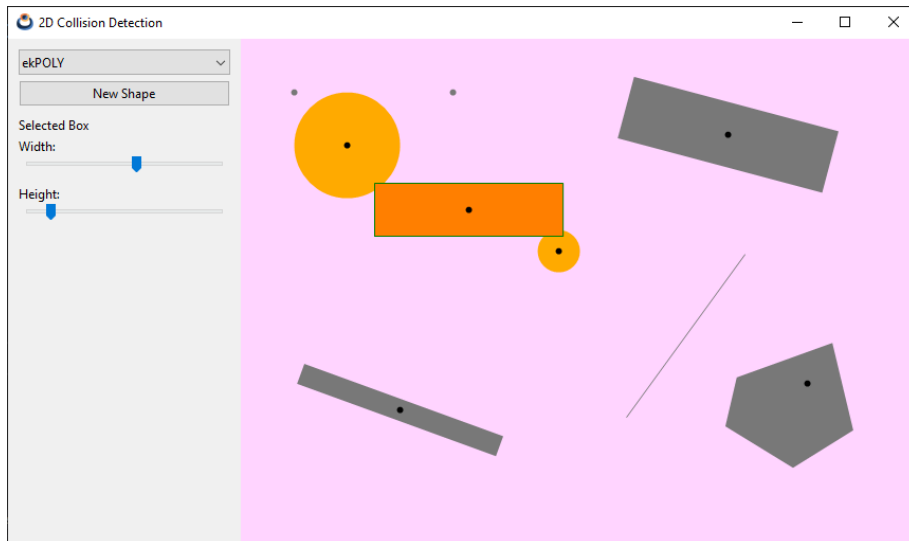

Figure 31.1: Windows version.

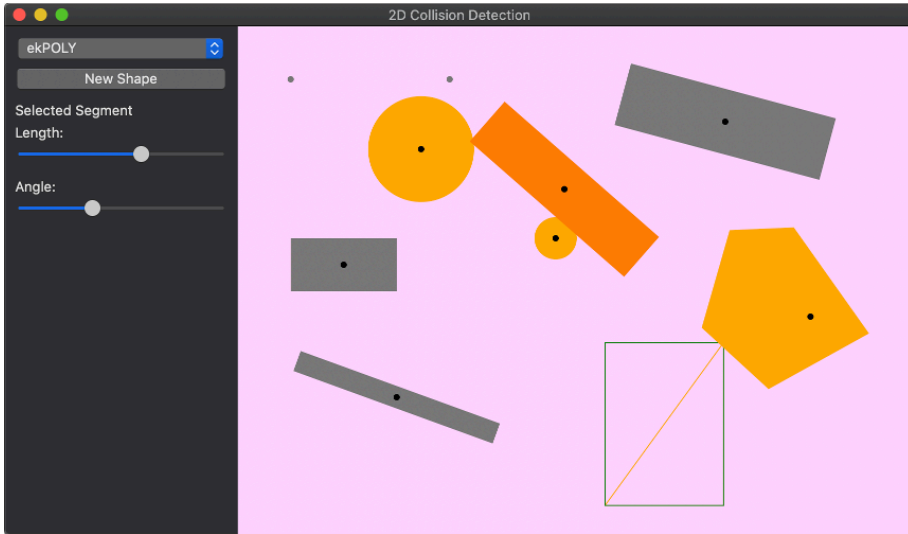

Figure 31.2: MacOS version.

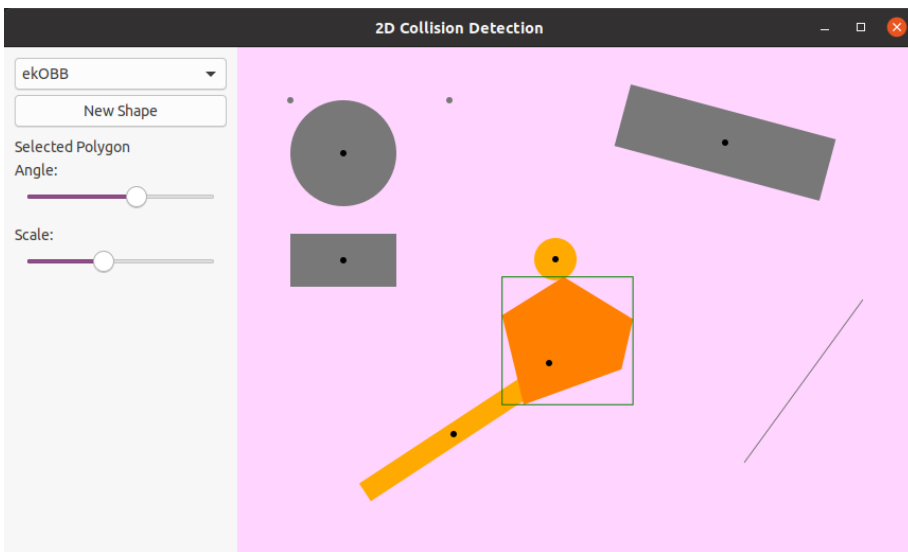

Figure 31.3: Linux version.

Listing 31.1: demo/col2dhello/col2dhello.c

```

/* 2D collision detection demo */

#include "col2dgui.h"
#include <nappgui.h>

/*-----*/

```

```

static void i_OnClose(App *app, Event *e)
{
    osapp_finish();
    unref(app);
    unref(e);
}

/*-----*/

static Tri2Df i_triangle(void)
{
    Tri2Df tri = tri2df(-3, 4, -1, -2, 7, -2);
    cassert(tri2d_ccwf(&tri) == TRUE);
    return tri;
}

/*-----*/

static Pol2Df *i_convex_pol(void)
{
    V2Df pt[] = {{4, 1}, {2, 5}, {-3, 5}, {-4, 2}, {0, -3}};
    Pol2Df *pol = NULL;
    bmem_rev_elems(pt, sizeof(pt) / sizeof(V2Df), V2Df);
    pol = pol2d_createf(pt, sizeof(pt) / sizeof(V2Df));
    cassert(pol2d_convexf(pol) == TRUE);
    cassert(pol2d_ccwf(pol) == FALSE);
    return pol;
}

/*-----*/

static Pol2Df *i_simple_pol(void)
{
    V2Df pt[] = {{9.78f, 12.17f}, {-10.00f, 11.01f}, {-9.68f, 3.20f}, {-9.30f,
    ↪ -5.98f}, {-4.27f, -5.84f}, {-4.03f, -12.17f}, {2.72f, -12.12f},
    ↪ {2.47f, -6.36f}, {2.04f, 3.26f}, {-1.45f, 3.05f}, {-1.08f, -2.08f},
    ↪ {-3.98f, -2.38f}, {-4.23f, 2.88f}, {-1.45f, 3.05f}, {2.04f, 3.26f},
    ↪ {10.00f, 3.75f}};
    Pol2Df *pol = NULL;
    bmem_rev_elems(pt, sizeof(pt) / sizeof(V2Df), V2Df);
    pol = pol2d_createf(pt, sizeof(pt) / sizeof(V2Df));
    cassert(pol2d_convexf(pol) == FALSE);
    cassert(pol2d_ccwf(pol) == FALSE);
    return pol;
}

/*-----*/

static Shape *i_new_shape(ArrSt(Shape) *shapes, const shtype_t type)
{

```



```

Shape *shape = arrst_new(shapes, Shape);
shape->type = type;
shape->mouse = FALSE;
shape->collisions = 0;
return shape;
}

/*-----*/

static void i_new_pnt(ArrSt(Shape) *shapes, const real32_t x, const real32_t y)
{
    Shape *shape = i_new_shape(shapes, ekPOINT);
    shape->body.pnt.x = x;
    shape->body.pnt.y = y;
}

/*-----*/

static void i_new_cloud(ArrSt(Shape) *shapes, const real32_t x, const real32_t
    ↪ y, const real32_t w, const real32_t h, const real32_t a)
{
    Shape *shape = i_new_shape(shapes, ekPOINT_CLOUD);
    shape->body.cloud.pnts = arrst_create(V2Df);
    shape->body.cloud.center.x = x;
    shape->body.cloud.center.y = y;
    shape->body.cloud.width = w;
    shape->body.cloud.height = h;
    shape->body.cloud.angle = a;
    shape->body.cloud.ctype = 0;
    shape->body.cloud.type = 0;
    (void)arrst_new_n(shape->body.cloud.pnts, POINT_CLOUD_N, V2Df);
    col2dhello_update_cloud(&shape->body.cloud);
}

/*-----*/

static void i_new_seg(ArrSt(Shape) *shapes, const real32_t x, const real32_t y,
    ↪ const real32_t l, const real32_t a)
{
    Shape *shape = i_new_shape(shapes, ekSEGMENT);
    shape->body(seg.center.x = x;
    shape->body(seg.center.y = y;
    shape->body(seg.length = l;
    shape->body(seg.angle = a;
    col2dhello_update_seg(&shape->body(seg);
}

/*-----*/

static void i_new_cir(ArrSt(Shape) *shapes, const real32_t x, const real32_t y,
    ↪ const real32_t r)

```

```

{
    Shape *shape = i_new_shape(shapes, ekCIRCLE);
    shape->body.cir.r = r;
    shape->body.cir.c.x = x;
    shape->body.cir.c.y = y;
}

/*-----*/

static void i_new_box(ArrSt(Shape) *shapes, const real32_t x, const real32_t y,
    ↪ const real32_t w, const real32_t h)
{
    Shape *shape = i_new_shape(shapes, ekBOX);
    shape->body.box.center.x = x;
    shape->body.box.center.y = y;
    shape->body.box.width = w;
    shape->body.box.height = h;
    col2dhello_update_box(&shape->body.box);
}

/*-----*/

static void i_new_obb(ArrSt(Shape) *shapes, const real32_t x, const real32_t y,
    ↪ const real32_t w, const real32_t h, const real32_t a)
{
    Shape *shape = i_new_shape(shapes, ekOBB);
    shape->body.obb.center.x = x;
    shape->body.obb.center.y = y;
    shape->body.obb.angle = a;
    shape->body.obb.width = w;
    shape->body.obb.height = h;
    shape->body.obb.obb = NULL;
    col2dhello_update_obb(&shape->body.obb);
}

/*-----*/

static void i_new_tri(ArrSt(Shape) *shapes, const real32_t x, const real32_t y,
    ↪ const real32_t a, const real32_t s)
{
    Shape *shape = i_new_shape(shapes, ekTRIANGLE);
    shape->body.tri.center.x = x;
    shape->body.tri.center.y = y;
    shape->body.tri.angle = a;
    shape->body.tri.scale = s;
    shape->body.tri.t2d = *kT2D_IDENTf;
    shape->body.tri.tri = i_triangle();
    col2dhello_update_tri(&shape->body.tri);
}

/*-----*/

```

```

static void i_new_pol(ArrSt(Shape) *shapes, const shtype_t type, const real32_t
    ↪ x, const real32_t y, const real32_t a, const real32_t s)
{
    Shape *shape = i_new_shape(shapes, type);
    shape->body.pol.center.x = x;
    shape->body.pol.center.y = y;
    shape->body.pol.angle = a;
    shape->body.pol.scale = s;
    shape->body.pol.t2d = *kT2D_IDENTf;
    shape->body.pol.pol = type == ekCONVEX_POLY ? i_convex_pol() : i_simple_pol
    ↪ ();
    col2dhello_update_pol(&shape->body.pol);
}

/*-----*/

static ArrSt(Shape) *i_shapes(void)
{
    ArrSt(Shape) *shapes = arrst_create(Shape);
    i_new_pnt(shapes, 520, 230);
    i_new_pnt(shapes, 220, 205);
    i_new_seg(shapes, 420, 280, 190, 125 * kBMATH_DEG2RADf);
    i_new_cir(shapes, 100, 100, 50);
    i_new_cir(shapes, 300, 200, 20);
    i_new_box(shapes, 100, 225, 100, 50);
    i_new_obb(shapes, 150, 350, 200, 20, 200 * kBMATH_DEG2RADf);
    i_new_obb(shapes, 460, 90, 200, 60, 15 * kBMATH_DEG2RADf);
    i_new_tri(shapes, 550, 475, 75 * kBMATH_DEG2RADf, 15);
    i_new_tri(shapes, 90, 480, 355 * kBMATH_DEG2RADf, 18);
    i_new_pol(shapes, ekCONVEX_POLY, 535, 325, 30 * kBMATH_DEG2RADf, 15);
    i_new_pol(shapes, ekSIMPLE_POLY, 370, 450, 45 * kBMATH_DEG2RADf, 7);
    return shapes;
}

/*-----*/

static App *i_create(void)
{
    App *app = heap_new0(App);
    col2dhello_dbind();
    app->shapes = i_shapes();
    app->dists = arrst_create(Dist);
    app->seltype = ekOBB;
    app->selshape = UINT32_MAX;
    app->show_seg_pt = TRUE;
    app->show_triangles = FALSE;
    app->show_convex_parts = FALSE;
    app->sel_area = 0;
    app->window = col2dhello_window(app);
    window_title(app->window, "2D Collision Detection");
}

```

```

window_origin(app->window, v2df(500, 200));
window_OnClose(app->window, listener(app, i_OnClose, App));
window_show(app->window);
col2dhello_dbind_shape(app);
col2dhello_collisions(app);
return app;
}

/*-----*/

static void i_remove_bounds(Cloud *cloud)
{
    cassert_no_null(cloud);
    switch (cloud->ctype)
    {
        case 0:
        case 1:
        case 2:
            break;
        case 3:
            obb2d_destroyf(&cloud->bound.obb);
            break;
        case 4:
            pol2d_destroyf(&cloud->bound.poly);
            break;
        cassert_default();
    }
}

/*-----*/

static void i_remove_shape(Shape *shape)
{
    cassert_no_null(shape);
    switch (shape->type)
    {
        case ekPOINT_CLOUD:
            arrst_destroy(&shape->body.cloud.pnts, NULL, V2Df);
            i_remove_bounds(&shape->body.cloud);
            break;

        case ekOBB:
            obb2d_destroyf(&shape->body.obb.obb);
            break;

        case ekCONVEX_POLY:
        case ekSIMPLE_POLY:
            pol2d_destroyf(&shape->body.pol.pol);
            break;

        case ekPOINT:

```

```

    case ekSEGMENT:
    case ekCIRCLE:
    case ekBOX:
    case ekTRIANGLE:
        break;

        cassert_default();
    }
}

/*-----*/

static void i_destroy(App **app)
{
    arrst_destroy(&(*app)->shapes, i_remove_shape, Shape);
    arrst_destroy(&(*app)->dists, NULL, Dist);
    window_destroy(&(*app)->window);
    heap_delete(app, App);
}

/*-----*/

void col2dhello_new_shape(App *app, const V2Df pos)
{
    switch (app->seltype)
    {
    case ekPOINT:
        i_new_pnt(app->shapes, pos.x, pos.y);
        break;

    case ekPOINT_CLOUD:
        i_new_cloud(app->shapes, pos.x, pos.y, 100, 50, 15 * kBMATH_DEG2RADf);
        break;

    case ekSEGMENT:
        i_new_seg(app->shapes, pos.x, pos.y, 100, 15 * kBMATH_DEG2RADf);
        break;

    case ekCIRCLE:
        i_new_cir(app->shapes, pos.x, pos.y, 30);
        break;

    case ekBOX:
        i_new_box(app->shapes, pos.x, pos.y, 100, 50);
        break;

    case ekOBB:
        i_new_obb(app->shapes, pos.x, pos.y, 100, 50, 15 * kBMATH_DEG2RADf);
        break;

    case ekTRIANGLE:

```

```

    i_new_tri(app->shapes, pos.x, pos.y, 15 * KBMATH_DEG2RADf, 15);
    break;

case ekCONVEX_POLY:
    i_new_pol(app->shapes, ekCONVEX_POLY, pos.x, pos.y, 0, 10);
    break;

case ekSIMPLE_POLY:
    i_new_pol(app->shapes, ekSIMPLE_POLY, pos.x, pos.y, 0, 10);
    break;

    cassert_default();
}

app->selshape = arrst_size(app->shapes, Shape) - 1;
}

/*-----*/

void col2dhello_update_gui(App *app)
{
    cassert_no_null(app);
    if (app->selshape != UINT32_MAX)
    {
        Shape *shape = arrst_get(app->shapes, app->selshape, Shape);
        switch (shape->type)
        {
            case ekPOINT:
            case ekPOINT_CLOUD:
            case ekSEGMENT:
                app->sel_area = 0;
                break;

            case ekCIRCLE:
                app->sel_area = cir2d_areaf(&shape->body.cir);
                break;

            case ekBOX:
                app->sel_area = box2d_areaf(&shape->body.box.box);
                break;

            case ekOBB:
                app->sel_area = obb2d_areaf(shape->body.obb.obb);
                break;

            case ekTRIANGLE:
                app->sel_area = tri2d_areaf(&shape->body.tri.tri);
                break;

            case ekCONVEX_POLY:
            case ekSIMPLE_POLY:

```

```

        app->sel_area = pol2d_areaf(shape->body.pol.pol);
        break;

        cassert_default();
    }
}
else
{
    app->sel_area = 0;
}

layout_dbind_obj(app->main_layout, app, App);
panel_update(app->obj_panel);
view_update(app->view);
}

/*-----*/

void col2dhello_update_seg(Seg *seg)
{
    V2Df hvec;
    cassert_no_null(seg);
    hvec.x = seg->length / 2;
    hvec.y = 0;
    v2d_rotatef(&hvec, seg->angle);
    seg->seg.p0.x = seg->center.x - hvec.x;
    seg->seg.p0.y = seg->center.y - hvec.y;
    seg->seg.p1.x = seg->center.x + hvec.x;
    seg->seg.p1.y = seg->center.y + hvec.y;
}

/*-----*/

Box2Df col2dhello_cloud_box(const Cloud *cloud)
{
    Box2Df box = cloud->box;
    box.min = v2d_addf(&cloud->box.min, &cloud->center);
    box.max = v2d_addf(&cloud->box.max, &cloud->center);
    return box;
}

/*-----*/

void col2dhello_update_cloud(Cloud *cloud)
{
    V2Df *pt = NULL;
    uint32_t i, n;
    real32_t hw, hh;
    cassert_no_null(cloud);
    pt = arrst_all(cloud->pnts, V2Df);
    n = arrst_size(cloud->pnts, V2Df);

```

```

hw = cloud->width / 2;
hh = cloud->height / 2;

for (i = 0; i < n; ++i)
{
    real32_t ox = bmath_randf(-.3f * hw, .3f * hw);
    real32_t oy = bmath_randf(-.3f * hh, .3f * hh);
    pt[i].x = bmath_randf(-hw, hw) + ox;
    pt[i].y = bmath_randf(-hh, hh) + oy;
}

if (cloud->angle != 0)
{
    T2Df t2d;
    t2d_rotatef(&t2d, kT2D_IDENTf, cloud->angle);
    t2d_vmultnf(pt, &t2d, pt, n);
}

cloud->box = box2d_from_pointsf(pt, n);
col2dhello_update_cloud_bounds(cloud);
}

/*-----*/

void col2dhello_update_cloud_bounds(Cloud *cloud)
{
    const V2Df *p = arrst_all(cloud->pnts, V2Df);
    uint32_t n = arrst_size(cloud->pnts, V2Df);

    i_remove_bounds(cloud);
    switch (cloud->type)
    {
    case 0:
        cloud->bound.cir = cir2d_from_boxf(&cloud->box);
        break;

    case 1:
        cloud->bound.cir = cir2d_from_pointsf(p, n);
        break;

    case 2:
        cloud->bound.cir = cir2d_minimumf(p, n);
        break;

    case 3:
        cloud->bound.obb = obb2d_from_pointsf(p, n);
        break;

    case 4:
        cloud->bound.poly = pol2d_convex_hullf(p, n);
        break;
    }
}

```



```

        cassert_default();
    }

    cloud->ctype = cloud->type;
}

/*-----*/

void col2dhello_update_box(Box *box)
{
    cassert_no_null(box);
    box->box.min.x = box->center.x - box->width / 2;
    box->box.min.y = box->center.y - box->height / 2;
    box->box.max.x = box->center.x + box->width / 2;
    box->box.max.y = box->center.y + box->height / 2;
}

/*-----*/

void col2dhello_update_obb(OBB *obb)
{
    cassert_no_null(obb);
    if (obb->obb == NULL)
        obb->obb = obb2d_createf(&obb->center, obb->width, obb->height, obb->
            ↪ angle);
    else
        obb2d_updatef(obb->obb, &obb->center, obb->width, obb->height, obb->
            ↪ angle);
}

/*-----*/

void col2dhello_update_tri(Tri *tri)
{
    T2Df t2d, nt2d;
    cassert_no_null(tri);
    t2d_inversef(&t2d, &tri->t2d);
    t2d_movef(&nt2d, kT2D_IDENTf, tri->center.x, tri->center.y);
    t2d_rotatef(&nt2d, &nt2d, tri->angle);
    t2d_scalef(&nt2d, &nt2d, tri->scale, tri->scale);
    t2d_multf(&t2d, &nt2d, &t2d);
    tri2d_transformf(&tri->tri, &t2d);
    tri->t2d = nt2d;
}

/*-----*/

void col2dhello_update_pol(Pol *pol)
{
    T2Df t2d, nt2d;
    cassert_no_null(pol);

```

```

cassert_no_null(pol->pol);
t2d_inversef(&t2d, &pol->t2d);
t2d_movef(&nt2d, kT2D_IDENTf, pol->center.x, pol->center.y);
t2d_rotatef(&nt2d, &nt2d, pol->angle);
t2d_scalef(&nt2d, &nt2d, pol->scale, pol->scale);
t2d_multf(&t2d, &nt2d, &t2d);
pol2d_transformf(pol->pol, &t2d);
pol->t2d = nt2d;
}

/*-----*/

static bool_t i_mouse_inside(const Shape *shape, const real32_t mouse_x, const
↪ real32_t mouse_y)
{
    V2Df m = v2df(mouse_x, mouse_y);

    switch (shape->type)
    {
    case ekPOINT:
        return col2d_point_pointf(&shape->body.pnt, &m, CENTER_RADIUS, NULL);

    case ekPOINT_CLOUD:
    {
        Box2Df box = col2dhello_cloud_box(&shape->body.cloud);
        return col2d_box_pointf(&box, &m, NULL);
    }

    case ekSEGMENT:
        return col2d_segment_pointf(&shape->body.seg.seg, &m, CENTER_RADIUS,
↪ NULL);

    case ekCIRCLE:
        return col2d_circle_pointf(&shape->body.cir, &m, NULL);

    case ekBOX:
        return col2d_box_pointf(&shape->body.box.box, &m, NULL);

    case ekOBB:
        return col2d_obb_pointf(shape->body.obb.obb, &m, NULL);

    case ekTRIANGLE:
        return col2d_tri_pointf(&shape->body.tri.tri, &m, NULL);

    case ekCONVEX_POLY:
    case ekSIMPLE_POLY:
        return col2d_poly_pointf(shape->body.pol.pol, &m, NULL);

        cassert_default();
    }
}

```

```

    return FALSE;
}

/*-----*/

void col2dhello_mouse_collisions(App *app, const real32_t mouse_x, const
    ↪ real32_t mouse_y)
{
    arrst_foreach(shape, app->shapes, Shape)
        shape->mouse = i_mouse_inside(shape, mouse_x, mouse_y);
    arrst_end()
}

/*-----*/

static void i_point_segment_dist(const Seg2Df *seg, const V2Df *pnt, ArrSt(Dist
    ↪ ) *dists)
{
    Dist *dist = arrst_new(dists, Dist);
    real32_t t = seg2d_close_paramf(seg, pnt);
    dist->p0 = *pnt;
    dist->p1 = seg2d_evalf(seg, t);
}

/*-----*/

void col2dhello_collisions(App *app)
{
    Shape *shape = arrst_all(app->shapes, Shape);
    uint32_t n = arrst_size(app->shapes, Shape);
    uint32_t i, j;

    arrst_clear(app->dists, NULL, Dist);

    for (i = 0; i < n; ++i)
        shape[i].collisions = 0;

    for (i = 0; i < n; ++i)
        for (j = i + 1; j < n; ++j)
        {
            const Shape *shapel = shape[i].type < shape[j].type ? &shape[i] : &
                ↪ shape[j];
            const Shape *shape2 = shape[i].type < shape[j].type ? &shape[j] : &
                ↪ shape[i];
            bool_t col = FALSE;

            switch (shapel->type)
            {
            case ekPOINT:
                switch (shape2->type)
                {

```

```

    case ekPOINT:
        col = col2d_point_pointf(&shapel->body.pnt, &shape2->body.
            ↪ pnt, CENTER_RADIUS, NULL);
        break;

    case ekPOINT_CLOUD:
        col = FALSE;
        break;

    case ekSEGMENT:
        col = col2d_segment_pointf(&shape2->body.seg.seg, &shapel->
            ↪ body.pnt, CENTER_RADIUS, NULL);
        i_point_segment_dist(&shape2->body.seg.seg, &shapel->body.
            ↪ pnt, app->dists);
        break;

    case ekCIRCLE:
        col = col2d_circle_pointf(&shape2->body.cir, &shapel->body.
            ↪ pnt, NULL);
        break;

    case ekBOX:
        col = col2d_box_pointf(&shape2->body.box.box, &shapel->body
            ↪ .pnt, NULL);
        break;

    case ekOBB:
        col = col2d_obb_pointf(shape2->body.obb.obb, &shapel->body.
            ↪ pnt, NULL);
        break;

    case ekTRIANGLE:
        col = col2d_tri_pointf(&shape2->body.tri.tri, &shapel->body
            ↪ .pnt, NULL);
        break;

    case ekCONVEX_POLY:
    case ekSIMPLE_POLY:
        col = col2d_poly_pointf(shape2->body.pol.pol, &shapel->body
            ↪ .pnt, NULL);
        break;

        cassert_default();
    }
    break;

    case ekPOINT_CLOUD:
        col = FALSE;
        break;

    case ekSEGMENT:

```

```

switch (shape2->type)
{
case ekSEGMENT:
    col = col2d_segment_segmentf(&shape1->body.seg.seg, &shape2
        ↪ ->body.seg.seg, NULL);
    break;

case ekCIRCLE:
    col = col2d_circle_segmentf(&shape2->body.cir, &shape1->
        ↪ body.seg.seg, NULL);
    break;

case ekBOX:
    col = col2d_box_segmentf(&shape2->body.box.box, &shape1->
        ↪ body.seg.seg, NULL);
    break;

case ekOBB:
    col = col2d_obb_segmentf(shape2->body.obb.obb, &shape1->
        ↪ body.seg.seg, NULL);
    break;

case ekTRIANGLE:
    col = col2d_tri_segmentf(&shape2->body.tri.tri, &shape1->
        ↪ body.seg.seg, NULL);
    break;

case ekCONVEX_POLY:
case ekSIMPLE_POLY:
    col = col2d_poly_segmentf(shape2->body.pol.pol, &shape1->
        ↪ body.seg.seg, NULL);
    break;

case ekPOINT:
case ekPOINT_CLOUD:
    cassert_default();
}
break;

case ekCIRCLE:
    switch (shape2->type)
    {
    case ekCIRCLE:
        col = col2d_circle_circlef(&shape1->body.cir, &shape2->body
            ↪ .cir, NULL);
        break;

    case ekBOX:
        col = col2d_box_circlef(&shape2->body.box.box, &shape1->
            ↪ body.cir, NULL);
        break;
    }
}

```

```

    case ekOBB:
        col = col2d_obb_circlef(shape2->body.obb.obb, &shape1->body
            ↪ .cir, NULL);
        break;

    case ekTRIANGLE:
        col = col2d_tri_circlef(&shape2->body.tri.tri, &shape1->
            ↪ body.cir, NULL);
        break;

    case ekCONVEX_POLY:
    case ekSIMPLE_POLY:
        col = col2d_poly_circlef(shape2->body.pol.pol, &shape1->
            ↪ body.cir, NULL);
        break;

    case ekPOINT:
    case ekPOINT_CLOUD:
    case ekSEGMENT:
        cassert_default();
    }
    break;

case ekBOX:
    switch (shape2->type)
    {
    case ekBOX:
        col = col2d_box_boxf(&shape1->body.box.box, &shape2->body.
            ↪ box.box, NULL);
        break;

    case ekOBB:
        col = col2d_obb_boxf(shape2->body.obb.obb, &shape1->body.
            ↪ box.box, NULL);
        break;

    case ekTRIANGLE:
        col = col2d_tri_boxf(&shape2->body.tri.tri, &shape1->body.
            ↪ box.box, NULL);
        break;

    case ekCONVEX_POLY:
    case ekSIMPLE_POLY:
        col = col2d_poly_boxf(shape2->body.pol.pol, &shape1->body.
            ↪ box.box, NULL);
        break;

    case ekPOINT:
    case ekPOINT_CLOUD:
    case ekSEGMENT:

```

```

        case ekCIRCLE:
            cassert_default();
        }
        break;

    case ekOBB:
        switch (shape2->type)
        {
            case ekOBB:
                col = col2d_obb_obbf(shape1->body.obb.obb, shape2->body.obb
                    ↪ .obb, NULL);
                break;

            case ekTRIANGLE:
                col = col2d_tri_obbf(&shape2->body.tri.tri, shape1->body.
                    ↪ obb.obb, NULL);
                break;

            case ekCONVEX_POLY:
            case ekSIMPLE_POLY:
                col = col2d_poly_obbf(shape2->body.pol.pol, shape1->body.
                    ↪ obb.obb, NULL);
                break;

            case ekPOINT:
            case ekPOINT_CLOUD:
            case ekSEGMENT:
            case ekCIRCLE:
            case ekBOX:
                cassert_default();
        }
        break;

    case ekTRIANGLE:
        switch (shape2->type)
        {
            case ekTRIANGLE:
                col = col2d_tri_trif(&shape1->body.tri.tri, &shape2->body.
                    ↪ tri.tri, NULL);
                break;

            case ekCONVEX_POLY:
            case ekSIMPLE_POLY:
                col = col2d_poly_trif(shape2->body.pol.pol, &shape1->body.
                    ↪ tri.tri, NULL);
                break;

            case ekPOINT:
            case ekPOINT_CLOUD:
            case ekSEGMENT:
            case ekCIRCLE:

```

```

        case ekBOX:
        case ekOBB:
            cassert_default();
        }
        break;

    case ekCONVEX_POLY:
    case ekSIMPLE_POLY:
        switch (shape2->type)
        {
            case ekCONVEX_POLY:
            case ekSIMPLE_POLY:
                col = col2d_poly_polyf(shape1->body.pol.pol, shape2->body.
                    ↪ pol.pol, NULL);
                break;

            case ekPOINT:
            case ekPOINT_CLOUD:
            case ekSEGMENT:
            case ekCIRCLE:
            case ekBOX:
            case ekOBB:
            case ekTRIANGLE:
                cassert_default();
            }
            break;

            cassert_default();
        }

    if (col == TRUE)
    {
        shape[i].collisions += 1;
        shape[j].collisions += 1;
    }
}

/*-----*/

#include "osmain.h"
osmain(i_create, i_destroy, "", App)

```

Listing 31.2: demo/col2dhello/col2dhello.hxx

```

/* 2D collision detection demo */

#ifndef __COL2DHELLO_HXX__
#define __COL2DHELLO_HXX__

#include <gui/gui.hxx>

```



```

#define CENTER_RADIUS      3
#define POINT_CLOUD_N     100

typedef struct _cloud_t Cloud;
typedef struct _seg_t Seg;
typedef struct _box_t Box;
typedef struct _obb_t OBB;
typedef struct _tri_t Tri;
typedef struct _pol_t Pol;
typedef struct _shape_t Shape;
typedef struct _dist_t Dist;
typedef struct _app_t App;

typedef enum _shtype_t
{
    ekPOINT,
    ekPOINT_CLOUD,
    ekSEGMENT,
    ekCIRCLE,
    ekBOX,
    ekOBB,
    ekTRIANGLE,
    ekCONVEX_POLY,
    ekSIMPLE_POLY
} shtype_t;

struct _cloud_t
{
    ArrSt(V2Df) *pnts;
    Box2Df box;
    V2Df center;
    real32_t width;
    real32_t height;
    real32_t angle;
    uint32_t ctype, type;

    union
    {
        Cir2Df cir;
        OBB2Df *obb;
        Pol2Df *poly;
    } bound;
};

struct _seg_t
{
    V2Df center;
    real32_t length;
    real32_t angle;
    Seg2Df seg;

```

```

};

struct _box_t
{
    V2Df center;
    real32_t width;
    real32_t height;
    Box2Df box;
};

struct _obb_t
{
    V2Df center;
    real32_t width;
    real32_t height;
    real32_t angle;
    OBB2Df *obb;
};

struct _tri_t
{
    V2Df center;
    real32_t angle;
    real32_t scale;
    T2Df t2d;
    Tri2Df tri;
};

struct _pol_t
{
    V2Df center;
    real32_t angle;
    real32_t scale;
    T2Df t2d;
    Pol2Df *pol;
};

struct _shape_t
{
    shtype_t type;
    bool_t mouse;
    uint32_t collisions;

    union {
        V2Df pnt;
        Cloud cloud;
        Seg seg;
        Cir2Df cir;
        Box box;
        OBB obb;
        Tri tri;
    };
};

```

```

        Pol pol;
    } body;
};

struct _dist_t
{
    V2Df p0;
    V2Df p1;
};

struct _app_t
{
    Window *window;
    View *view;
    Layout *main_layout;
    Layout *pnt_layout;
    Layout *cld_layout;
    Layout *seg_layout;
    Layout *cir_layout;
    Layout *box_layout;
    Layout *obb_layout;
    Layout *tri_layout;
    Layout *pol_layout;
    Panel *obj_panel;
    ArrSt(Shape) *shapes;
    ArrSt(Dist) *dists;
    shtype_t seltype;
    uint32_t selshape;
    bool_t show_seg_pt;
    bool_t show_triangles;
    bool_t show_convex_parts;
    real32_t sel_area;
    V2Df mouse_pos;
    V2Df obj_pos;
};

DeclSt(Shape);
DeclSt(Dist);

#endif

```

Listing 31.3: demo/col2dhello/col2dgui.c

```

/* Col2D Hello GUI */

#include "col2dgui.h"
#include <nappgui.h>

/*-----*/

void col2dhello_dbind(void)

```

```

{
    dbind_enum(shtype_t, ekPOINT, "");
    dbind_enum(shtype_t, ekPOINT_CLOUD, "");
    dbind_enum(shtype_t, ekSEGMENT, "");
    dbind_enum(shtype_t, ekCIRCLE, "");
    dbind_enum(shtype_t, ekBOX, "");
    dbind_enum(shtype_t, ekOBB, "");
    dbind_enum(shtype_t, ekTRIANGLE, "");
    dbind_enum(shtype_t, ekCONVEX_POLY, "");
    dbind_enum(shtype_t, ekSIMPLE_POLY, "");
    dbind(App, shtype_t, seltype);
    dbind(App, bool_t, show_seg_pt);
    dbind(App, bool_t, show_triangles);
    dbind(App, bool_t, show_convex_parts);
    dbind(App, real32_t, sel_area);
    dbind(Cloud, real32_t, width);
    dbind(Cloud, real32_t, height);
    dbind(Cloud, real32_t, angle);
    dbind(Cloud, uint32_t, type);
    dbind(Seg, real32_t, length);
    dbind(Seg, real32_t, angle);
    dbind(Cir2Df, real32_t, r);
    dbind(Box, real32_t, width);
    dbind(Box, real32_t, height);
    dbind(OBB, real32_t, width);
    dbind(OBB, real32_t, height);
    dbind(OBB, real32_t, angle);
    dbind(Tri, real32_t, angle);
    dbind(Tri, real32_t, scale);
    dbind(Pol, real32_t, angle);
    dbind(Pol, real32_t, scale);
    dbind_range(Cloud, real32_t, width, 50, 200);
    dbind_range(Cloud, real32_t, height, 50, 200);
    dbind_range(Cloud, real32_t, angle, 0, 360 * kBMATH_DEG2RADf);
    dbind_range(Seg, real32_t, length, 20, 300);
    dbind_range(Seg, real32_t, angle, 0, 360 * kBMATH_DEG2RADf);
    dbind_range(Cir2Df, real32_t, r, 5, 100);
    dbind_range(Box, real32_t, width, 20, 300);
    dbind_range(Box, real32_t, height, 20, 300);
    dbind_range(OBB, real32_t, width, 20, 300);
    dbind_range(OBB, real32_t, height, .2f, 300);
    dbind_range(OBB, real32_t, angle, 0, 360 * kBMATH_DEG2RADf);
    dbind_range(Tri, real32_t, angle, 0, 360 * kBMATH_DEG2RADf);
    dbind_range(Tri, real32_t, scale, 5, 30);
    dbind_range(Pol, real32_t, angle, 0, 360 * kBMATH_DEG2RADf);
    dbind_range(Pol, real32_t, scale, 5, 30);
}

/*-----*/

static void i_OnCloud(App *app, Event *e)

```

```

{
    Shape *shape = arrst_get(app->shapes, app->selshape, Shape);
    cassert(shape->type == ekPOINT_CLOUD);

    if (evbind_modify(e, Cloud, uint32_t, type) == TRUE)
        col2dhello_update_cloud_bounds(&shape->body.cloud);
    else
        col2dhello_update_cloud(&shape->body.cloud);

    col2dhello_collisions(app);
    col2dhello_update_gui(app);
}

/*-----*/

static void i_OnSeg(App *app, Event *e)
{
    Shape *shape = arrst_get(app->shapes, app->selshape, Shape);
    cassert(shape->type == ekSEGMENT);
    col2dhello_update_seg(&shape->body.seg);
    col2dhello_collisions(app);
    col2dhello_update_gui(app);
    unref(e);
}

/*-----*/

static void i_OnCircle(App *app, Event *e)
{
    col2dhello_collisions(app);
    col2dhello_update_gui(app);
    unref(e);
}

/*-----*/

static void i_OnBox(App *app, Event *e)
{
    Shape *shape = arrst_get(app->shapes, app->selshape, Shape);
    cassert(shape->type == ekBOX);
    col2dhello_update_box(&shape->body.box);
    col2dhello_collisions(app);
    col2dhello_update_gui(app);
    unref(e);
}

/*-----*/

static void i_OnOBB(App *app, Event *e)
{
    Shape *shape = arrst_get(app->shapes, app->selshape, Shape);

```

```

    cassert(shape->type == ekOBB);
    col2dhello_update_obb(&shape->body.obb);
    col2dhello_collisions(app);
    col2dhello_update_gui(app);
    unref(e);
}

/*-----*/

static void i_OnTri(App *app, Event *e)
{
    Shape *shape = arrst_get(app->shapes, app->selshape, Shape);
    cassert(shape->type == ekTRIANGLE);
    col2dhello_update_tri(&shape->body.tri);
    col2dhello_collisions(app);
    col2dhello_update_gui(app);
    unref(e);
}

/*-----*/

static void i_OnPoly(App *app, Event *e)
{
    Shape *shape = arrst_get(app->shapes, app->selshape, Shape);
    cassert(shape->type == ekCONVEX_POLY || shape->type == ekSIMPLE_POLY);
    col2dhello_update_pol(&shape->body.pol);
    col2dhello_collisions(app);
    col2dhello_update_gui(app);
    unref(e);
}

/*-----*/

static void i_OnOpt(App *app, Event *e)
{
    col2dhello_update_gui(app);
    unref(e);
}

/*-----*/

static Layout *i_empty_layout(void)
{
    Layout *layout = layout_create(1, 1);
    return layout;
}

/*-----*/

static Layout *i_point_layout(App *app)
{

```

```

    Layout *layout = layout_create(1, 1);
    Label *label = label_create();
    label_text(label, "Selected Point");
    layout_label(layout, label, 0, 0);
    app->pnt_layout = layout;
    return layout;
}

/*-----*/

static Layout *i_bounding_layout(void)
{
    Layout *layout = layout_create(1, 5);
    Button *button1 = button_radio();
    Button *button2 = button_radio();
    Button *button3 = button_radio();
    Button *button4 = button_radio();
    Button *button5 = button_radio();
    button_text(button1, "BBox Circle");
    button_text(button2, "Points Circle");
    button_text(button3, "Minimum Circle");
    button_text(button4, "Gaussian OBB");
    button_text(button5, "Convex Hull");
    layout_button(layout, button1, 0, 0);
    layout_button(layout, button2, 0, 1);
    layout_button(layout, button3, 0, 2);
    layout_button(layout, button4, 0, 3);
    layout_button(layout, button5, 0, 4);
    layout_vmargin(layout, 0, 5);
    layout_vmargin(layout, 1, 5);
    layout_vmargin(layout, 2, 5);
    layout_vmargin(layout, 3, 5);
    cell_dbind(layout_cell(layout, 0, 0), Cloud, uint32_t, type);
    return layout;
}

/*-----*/

static Layout *i_cloud_layout(App *app)
{
    Layout *layout1 = layout_create(1, 9);
    Layout *layout2 = i_bounding_layout();
    Label *label1 = label_create();
    Label *label2 = label_create();
    Label *label3 = label_create();
    Label *label4 = label_create();
    Label *label5 = label_create();
    Slider *slider1 = slider_create();
    Slider *slider2 = slider_create();
    Slider *slider3 = slider_create();
    label_text(label1, "Selected Point Cloud");

```

```

label_text(label2, "Width:");
label_text(label3, "Height:");
label_text(label4, "Angle:");
label_text(label5, "Bounding Volume");
layout_label(layout1, label1, 0, 0);
layout_label(layout1, label2, 0, 1);
layout_label(layout1, label3, 0, 3);
layout_label(layout1, label4, 0, 5);
layout_label(layout1, label5, 0, 7);
layout_slider(layout1, slider1, 0, 2);
layout_slider(layout1, slider2, 0, 4);
layout_slider(layout1, slider3, 0, 6);
layout_layout(layout1, layout2, 0, 8);
layout_vmargin(layout1, 0, 5);
layout_vmargin(layout1, 2, 10);
layout_vmargin(layout1, 4, 10);
layout_vmargin(layout1, 6, 5);
layout_vmargin(layout1, 7, 8);
cell_dbind(layout_cell(layout1, 0, 2), Cloud, real32_t, width);
cell_dbind(layout_cell(layout1, 0, 4), Cloud, real32_t, height);
cell_dbind(layout_cell(layout1, 0, 6), Cloud, real32_t, angle);
layout_dbind(layout1, listener(app, i_OnCloud, App), Cloud);
app->cld_layout = layout1;
return layout1;
}

/*-----*/

static Layout *i_segment_layout(App *app)
{
    Layout *layout = layout_create(1, 5);
    Label *label1 = label_create();
    Label *label2 = label_create();
    Label *label3 = label_create();
    Slider *slider1 = slider_create();
    Slider *slider2 = slider_create();
    label_text(label1, "Selected Segment");
    label_text(label2, "Length:");
    label_text(label3, "Angle:");
    layout_label(layout, label1, 0, 0);
    layout_label(layout, label2, 0, 1);
    layout_label(layout, label3, 0, 3);
    layout_slider(layout, slider1, 0, 2);
    layout_slider(layout, slider2, 0, 4);
    layout_vmargin(layout, 0, 5);
    layout_vmargin(layout, 2, 10);
    cell_dbind(layout_cell(layout, 0, 2), Seg, real32_t, length);
    cell_dbind(layout_cell(layout, 0, 4), Seg, real32_t, angle);
    layout_dbind(layout, listener(app, i_OnSeg, App), Seg);
    app->seg_layout = layout;
    return layout;
}

```



```

}

/*-----*/

static Layout *i_circle_layout(App *app)
{
    Layout *layout = layout_create(1, 3);
    Label *label1 = label_create();
    Label *label2 = label_create();
    Slider *slider = slider_create();
    label_text(label1, "Selected Circle");
    label_text(label2, "Radix:");
    layout_label(layout, label1, 0, 0);
    layout_label(layout, label2, 0, 1);
    layout_slider(layout, slider, 0, 2);
    layout_vmargin(layout, 0, 5);
    cell_dbind(layout_cell(layout, 0, 2), Cir2Df, real32_t, r);
    layout_dbind(layout, listener(app, i_OnCircle, App), Cir2Df);
    app->cir_layout = layout;
    return layout;
}

/*-----*/

static Layout *i_box_layout(App *app)
{
    Layout *layout = layout_create(1, 5);
    Label *label1 = label_create();
    Label *label2 = label_create();
    Label *label3 = label_create();
    Slider *slider1 = slider_create();
    Slider *slider2 = slider_create();
    label_text(label1, "Selected Box");
    label_text(label2, "Width:");
    label_text(label3, "Height:");
    layout_label(layout, label1, 0, 0);
    layout_label(layout, label2, 0, 1);
    layout_label(layout, label3, 0, 3);
    layout_slider(layout, slider1, 0, 2);
    layout_slider(layout, slider2, 0, 4);
    layout_vmargin(layout, 0, 5);
    layout_vmargin(layout, 2, 10);
    cell_dbind(layout_cell(layout, 0, 2), Box, real32_t, width);
    cell_dbind(layout_cell(layout, 0, 4), Box, real32_t, height);
    layout_dbind(layout, listener(app, i_OnBox, App), Box);
    app->box_layout = layout;
    return layout;
}

/*-----*/

```

```

static Layout *i_obb_layout(App *app)
{
    Layout *layout = layout_create(1, 7);
    Label *label1 = label_create();
    Label *label2 = label_create();
    Label *label3 = label_create();
    Label *label4 = label_create();
    Slider *slider1 = slider_create();
    Slider *slider2 = slider_create();
    Slider *slider3 = slider_create();
    label_text(label1, "Selected Oriented Box");
    label_text(label2, "Width:");
    label_text(label3, "Height:");
    label_text(label4, "Angle:");
    layout_label(layout, label1, 0, 0);
    layout_label(layout, label2, 0, 1);
    layout_label(layout, label3, 0, 3);
    layout_label(layout, label4, 0, 5);
    layout_slider(layout, slider1, 0, 2);
    layout_slider(layout, slider2, 0, 4);
    layout_slider(layout, slider3, 0, 6);
    layout_vmargin(layout, 0, 5);
    layout_vmargin(layout, 2, 10);
    layout_vmargin(layout, 4, 10);
    cell_dbind(layout_cell(layout, 0, 2), OBB, real32_t, width);
    cell_dbind(layout_cell(layout, 0, 4), OBB, real32_t, height);
    cell_dbind(layout_cell(layout, 0, 6), OBB, real32_t, angle);
    layout_dbind(layout, listener(app, i_OnOBB, App), OBB);
    app->obb_layout = layout;
    return layout;
}

/*-----*/

static Layout *i_tri_layout(App *app)
{
    Layout *layout = layout_create(1, 5);
    Label *label1 = label_create();
    Label *label2 = label_create();
    Label *label3 = label_create();
    Slider *slider1 = slider_create();
    Slider *slider2 = slider_create();
    label_text(label1, "Selected Triangle");
    label_text(label2, "Angle:");
    label_text(label3, "Scale:");
    layout_label(layout, label1, 0, 0);
    layout_label(layout, label2, 0, 1);
    layout_label(layout, label3, 0, 3);
    layout_slider(layout, slider1, 0, 2);
    layout_slider(layout, slider2, 0, 4);
    layout_vmargin(layout, 0, 5);
}

```

```

    layout_vmargin(layout, 2, 10);
    cell_dbind(layout_cell(layout, 0, 2), Tri, real32_t, angle);
    cell_dbind(layout_cell(layout, 0, 4), Tri, real32_t, scale);
    layout_dbind(layout, listener(app, i_OnTri, App), Tri);
    app->tri_layout = layout;
    return layout;
}

/*-----*/

static Layout *i_pol_layout(App *app)
{
    Layout *layout = layout_create(1, 5);
    Label *label1 = label_create();
    Label *label2 = label_create();
    Label *label3 = label_create();
    Slider *slider1 = slider_create();
    Slider *slider2 = slider_create();
    label_text(label1, "Selected Polygon");
    label_text(label2, "Angle:");
    label_text(label3, "Scale:");
    layout_label(layout, label1, 0, 0);
    layout_label(layout, label2, 0, 1);
    layout_label(layout, label3, 0, 3);
    layout_slider(layout, slider1, 0, 2);
    layout_slider(layout, slider2, 0, 4);
    layout_vmargin(layout, 0, 5);
    layout_vmargin(layout, 2, 10);
    cell_dbind(layout_cell(layout, 0, 2), Pol, real32_t, angle);
    cell_dbind(layout_cell(layout, 0, 4), Pol, real32_t, scale);
    layout_dbind(layout, listener(app, i_OnPoly, App), Pol);
    app->pol_layout = layout;
    return layout;
}

/*-----*/

static void i_OnNewShape(App *app, Event *e)
{
    S2Df size;
    view_get_size(app->view, &size);
    col2dhello_new_shape(app, v2df(size.width / 2, size.height / 2));
    col2dhello_dbind_shape(app);
    col2dhello_collisions(app);
    view_update(app->view);
    unref(e);
}

/*-----*/

static Layout *i_new_layout(App *app)

```

```

{
    Layout *layout = layout_create(1, 2);
    PopUp *popup = popup_create();
    Button *button = button_push();
    button_text(button, "New Shape");
    button_OnClick(button, listener(app, i_OnNewShape, App));
    layout_popup(layout, popup, 0, 0);
    layout_button(layout, button, 0, 1);
    layout_vmargin(layout, 0, 5);
    cell_dbind(layout_cell(layout, 0, 0), App, shtype_t, seltype);
    return layout;
}

/*-----*/

static Layout *i_area_layout(void)
{
    Layout *layout = layout_create(2, 1);
    Label *labell1 = label_create();
    Label *label2 = label_create();
    label_text(labell1, "Area:");
    layout_label(layout, labell1, 0, 0);
    layout_label(layout, label2, 1, 0);
    layout_hmargin(layout, 0, 5);
    layout_halign(layout, 1, 0, ekJUSTIFY);
    layout_hexpand(layout, 1);
    cell_dbind(layout_cell(layout, 1, 0), App, real32_t, sel_area);
    return layout;
}

/*-----*/

static Layout *i_left_layout(App *app)
{
    Layout *layout1 = layout_create(1, 6);
    Layout *layout2 = i_new_layout(app);
    Layout *layout3 = i_area_layout();
    Layout *layout4 = i_empty_layout();
    Layout *layout5 = i_point_layout(app);
    Layout *layout6 = i_cloud_layout(app);
    Layout *layout7 = i_segment_layout(app);
    Layout *layout8 = i_circle_layout(app);
    Layout *layout9 = i_box_layout(app);
    Layout *layout10 = i_obb_layout(app);
    Layout *layout11 = i_tri_layout(app);
    Layout *layout12 = i_pol_layout(app);
    Button *button1 = button_check();
    Button *button2 = button_check();
    Button *button3 = button_check();
    Panel *panel = panel_create();
    button_text(button1, "Show Segment-Point distance");

```

```

button_text(button2, "Show Polygon triangles");
button_text(button3, "Show Convex partition");
panel_layout(panel, layout4);
panel_layout(panel, layout5);
panel_layout(panel, layout6);
panel_layout(panel, layout7);
panel_layout(panel, layout8);
panel_layout(panel, layout9);
panel_layout(panel, layout10);
panel_layout(panel, layout11);
panel_layout(panel, layout12);
layout_layout(layout1, layout2, 0, 0);
layout_button(layout1, button1, 0, 1);
layout_button(layout1, button2, 0, 2);
layout_button(layout1, button3, 0, 3);
layout_layout(layout1, layout3, 0, 4);
layout_panel(layout1, panel, 0, 5);
layout_vmargn(layout1, 0, 10);
layout_vmargn(layout1, 1, 5);
layout_vmargn(layout1, 2, 5);
layout_vmargn(layout1, 3, 5);
layout_vmargn(layout1, 4, 10);
layout_margin(layout1, 10);
app->obj_panel = panel;
app->main_layout = layout1;
cell_dbind(layout_cell(layout1, 0, 1), App, bool_t, show_seg_pt);
cell_dbind(layout_cell(layout1, 0, 2), App, bool_t, show_triangles);
cell_dbind(layout_cell(layout1, 0, 3), App, bool_t, show_convex_parts);
layout_dbind(layout1, listener(app, i_OnOpt, App), App);
layout_dbind_obj(layout1, app, App);
return layout1;
}

/*-----*/

static color_t i_color(const uint32_t collision, const bool_t mouse)
{
    if (collision > 0)
    {
        if (collision == 1)
            return color_rgb(255, 170, 0);

        if (collision == 2)
            return color_rgb(255, 127, 0);

        return color_rgb(255, 42, 0);
    }
    else
    {
        if (mouse == TRUE)
            return color_rgb(127, 85, 255);
    }
}

```

```

        return color_gray(120);
    }
}

/*-----*/

static void i_draw_point(DCtx *ctx, const V2Df *pt)
{
    draw_v2df(ctx, ekFILL, pt, CENTER_RADIUS);
}

/*-----*/

static void i_draw_cloud(DCtx *ctx, const Cloud *cloud)
{
    arrst_foreach(pt, cloud->pnts, V2Df)
        draw_circle(ctx, ekSTROKE, pt->x + cloud->center.x, pt->y + cloud->
            ↪ center.y, 1);
    arrst_end()

    switch (cloud->type)
    {
    case 0:
    case 1:
    case 2:
    {
        real32_t cx = cloud->bound.cir.c.x + cloud->center.x;
        real32_t cy = cloud->bound.cir.c.y + cloud->center.y;
        draw_circle(ctx, ekSTROKE, cx, cy, cloud->bound.cir.r);
        draw_fill_color(ctx, kCOLOR_BLACK);
        draw_circle(ctx, ekFILL, cx, cy, CENTER_RADIUS);
        break;
    }

    case 3:
    {
        T2Df t2d;
        V2Df center = obb2d_centerf(cloud->bound.obb);
        t2d_movef(&t2d, kT2D_IDENTf, cloud->center.x, cloud->center.y);
        draw_matrixf(ctx, &t2d);
        draw_obb2df(ctx, ekSTROKE, cloud->bound.obb);
        draw_fill_color(ctx, kCOLOR_BLACK);
        draw_circle(ctx, ekFILL, center.x, center.y, CENTER_RADIUS);
        draw_matrixf(ctx, kT2D_IDENTf);
        break;
    }

    case 4:
    {
        T2Df t2d;

```

```

        V2Df center = pol2d_centroidf(cloud->bound.poly);
        t2d_movef(&t2d, kT2D_IDENTf, cloud->center.x, cloud->center.y);
        draw_matrixf(ctx, &t2d);
        draw_pol2df(ctx, ekSTROKE, cloud->bound.poly);
        draw_fill_color(ctx, kCOLOR_BLACK);
        draw_circle(ctx, ekFILL, center.x, center.y, CENTER_RADIUS);
        draw_matrixf(ctx, kT2D_IDENTf);
        break;
    }

    cassert_default();
}

/*-----*/

static void i_draw_segment(DCtx *ctx, const Seg *seg)
{
    draw_seg2df(ctx, &seg->seg);
}

/*-----*/

static void i_draw_circle(DCtx *ctx, const Cir2Df *circle)
{
    draw_cir2df(ctx, ekFILL, circle);
    draw_fill_color(ctx, kCOLOR_BLACK);
    draw_circle(ctx, ekFILL, circle->c.x, circle->c.y, CENTER_RADIUS);
}

/*-----*/

static void i_draw_box(DCtx *ctx, const Box *box)
{
    draw_box2df(ctx, ekFILL, &box->box);
    draw_fill_color(ctx, kCOLOR_BLACK);
    draw_circle(ctx, ekFILL, box->center.x, box->center.y, CENTER_RADIUS);
}

/*-----*/

static void i_draw_obb(DCtx *ctx, const OBB *obb)
{
    draw_obb2df(ctx, ekFILL, obb->obb);
    draw_fill_color(ctx, kCOLOR_BLACK);
    draw_circle(ctx, ekFILL, obb->center.x, obb->center.y, CENTER_RADIUS);
}

/*-----*/

static void i_draw_tri(DCtx *ctx, const Tri *tri)

```

```

{
    V2Df center = tri2d_centroidf(&tri->tri);
    draw_tri2df(ctx, ekFILL, &tri->tri);
    draw_fill_color(ctx, kCOLOR_BLACK);
    draw_circle(ctx, ekFILL, center.x, center.y, CENTER_RADIUS);
}

/*-----*/

static void i_draw_poly(DCtx *ctx, const Pol *pol)
{
    V2Df center = pol2d_visual_centerf(pol->pol, .05f);
    draw_pol2df(ctx, ekFILL, pol->pol);
    draw_fill_color(ctx, kCOLOR_BLACK);
    draw_circle(ctx, ekFILL, center.x, center.y, CENTER_RADIUS);
}

/*-----*/

static void i_draw_poly_triangles(DCtx *ctx, const Pol2Df *poly)
{
    ArrSt(Tri2Df) *triangles = pol2d_trianglesf(poly);
    bool_t ccw = pol2d_ccwf(poly);

    arrst_foreach(tri, triangles, Tri2Df)
        cassert_unref(tri2d_ccwf(tri) == ccw, ccw);
        draw_tri2df(ctx, ekSTROKE, tri);
    arrst_end()

    arrst_destroy(&triangles, NULL, Tri2Df);
}

/*-----*/

static void i_draw_poly_convex_parts(DCtx *ctx, const Pol2Df *poly)
{
    ArrPt(Pol2Df) *convex_polys = pol2d_convex_partitionf(poly);
    bool_t ccw = pol2d_ccwf(poly);

    arrpt_foreach(convex, convex_polys, Pol2Df)
        cassert(pol2d_convexf(convex) == TRUE);
        cassert_unref(pol2d_ccwf(convex) == ccw, ccw);
        draw_pol2df(ctx, ekSTROKE, convex);
    arrpt_end()

    arrpt_destroy(&convex_polys, pol2d_destroyf, Pol2Df);
}

/*-----*/

static void i_draw_bbox(DCtx *ctx, const Shape *shape)

```



```

{
    Box2Df bbox = kBOX2D_NULLf;
    real32_t p[2] = {2, 2};
    switch (shape->type)
    {
    case ekPOINT:
    {
        Cir2Df c = cir2df(shape->body.pnt.x, shape->body.pnt.y, CENTER_RADIUS);
        box2d_add_circlef(&bbox, &c);
        break;
    }

    case ekPOINT_CLOUD:
        bbox = col2dhello_cloud_box(&shape->body.cloud);
        break;

    case ekSEGMENT:
        box2d_addf(&bbox, &shape->body.seg.seg.p0);
        box2d_addf(&bbox, &shape->body.seg.seg.p1);
        break;

    case ekCIRCLE:
        box2d_add_circlef(&bbox, &shape->body.cir);
        break;

    case ekBOX:
        box2d_mergef(&bbox, &shape->body.box.box);
        break;

    case ekOBB:
    {
        const V2Df *corners = obb2d_cornersf(shape->body.obb.obb);
        box2d_addnf(&bbox, corners, 4);
        break;
    }

    case ekTRIANGLE:
    {
        const V2Df *points = (const V2Df *)&shape->body.tri.tri;
        box2d_addnf(&bbox, points, 3);
        break;
    }

    case ekCONVEX_POLY:
    case ekSIMPLE_POLY:
    {
        const V2Df *points = pol2d_pointsf(shape->body.pol.pol);
        uint32_t n = pol2d_nf(shape->body.pol.pol);
        box2d_addnf(&bbox, points, n);
        break;
    }
}

```

```

        cassert_default();
    }

    draw_line_color(ctx, color_rgb(0, 128, 0));
    draw_line_dash(ctx, p, 2);
    draw_box2df(ctx, ekSTROKE, &bbox);
    draw_line_dash(ctx, NULL, 0);
}

/*-----*/

static void i_OnDraw(App *app, Event *e)
{
    const EvDraw *p = event_params(e, EvDraw);
    real32_t dash[2] = {2, 2};
    draw_clear(p->ctx, color_rgb(255, 212, 255));

    arrst_foreach(shape, app->shapes, Shape)
        draw_fill_color(p->ctx, i_color(shape->collisions, shape->mouse));
        draw_line_color(p->ctx, i_color(shape->collisions, shape->mouse));

    switch (shape->type)
    {
    case ekPOINT:
        i_draw_point(p->ctx, &shape->body.pnt);
        break;

    case ekPOINT_CLOUD:
        i_draw_cloud(p->ctx, &shape->body.cloud);
        break;

    case ekSEGMENT:
        i_draw_segment(p->ctx, &shape->body.seg);
        break;

    case ekCIRCLE:
        i_draw_circle(p->ctx, &shape->body.cir);
        break;

    case ekBOX:
        i_draw_box(p->ctx, &shape->body.box);
        break;

    case ekOBB:
        i_draw_obb(p->ctx, &shape->body.obb);
        break;

    case ekTRIANGLE:
        i_draw_tri(p->ctx, &shape->body.tri);
        break;
    }
}

```

```

    case ekCONVEX_POLY:
    case ekSIMPLE_POLY:
        i_draw_poly(p->ctx, &shape->body.pol);
        break;

        cassert_default();
    }

    if (app->selshape == shape_i)
        i_draw_bbox(p->ctx, shape);

arrst_end()

if (app->show_seg_pt == TRUE)
{
    real32_t pattern[2] = {2, 2};
    draw_line_dash(p->ctx, pattern, 2);
    draw_line_color(p->ctx, kCOLOR_MAGENTA);
    arrst_foreach(dist, app->dists, Dist)
        draw_line(p->ctx, dist->p0.x, dist->p0.y, dist->p1.x, dist->p1.y);
    arrst_end()
}

draw_line_width(p->ctx, 1);
draw_line_color(p->ctx, kCOLOR_BLACK);
draw_line_dash(p->ctx, dash, 2);

if (app->show_triangles == TRUE)
{
    arrst_foreach(shape, app->shapes, Shape)
        if (shape->type == ekCONVEX_POLY || shape->type == ekSIMPLE_POLY)
            i_draw_poly_triangles(p->ctx, shape->body.pol.pol);
    arrst_end()
}

if (app->show_triangles == FALSE && app->show_convex_parts == TRUE)
{
    arrst_foreach(shape, app->shapes, Shape)
        if (shape->type == ekSIMPLE_POLY)
            i_draw_poly_convex_parts(p->ctx, shape->body.pol.pol);
    arrst_end()
}

draw_line_dash(p->ctx, NULL, 2);
}

/*-----*/

static void i_OnMove(App *app, Event *e)
{

```

```

    const EvMouse *p = event_params(e, EvMouse);
    View *view = event_sender(e, View);
    col2dhello_mouse_collisions(app, p->x, p->y);
    view_update(view);
}

/*-----*/

static void i_get_shape_pos(const Shape *shape, V2Df *pos)
{
    switch (shape->type)
    {
        case ekPOINT:
            *pos = shape->body.pnt;
            break;

        case ekPOINT_CLOUD:
            *pos = shape->body.cloud.center;
            break;

        case ekSEGMENT:
            *pos = shape->body.seg.center;
            break;

        case ekCIRCLE:
            *pos = shape->body.cir.c;
            break;

        case ekBOX:
            *pos = shape->body.box.center;
            break;

        case ekOBB:
            *pos = shape->body.obb.center;
            break;

        case ekTRIANGLE:
            *pos = shape->body.tri.center;
            *pos = shape->body.tri.center;
            break;

        case ekCONVEX_POLY:
        case ekSIMPLE_POLY:
            *pos = shape->body.pol.center;
            break;

        cassert_default();
    }
}

/*-----*/

```

```

static void i_set_shape_pos(Shape *shape, const V2Df pos)
{
    switch (shape->type)
    {
        case ekPOINT:
            shape->body.pnt = pos;
            break;

        case ekPOINT_CLOUD:
            shape->body.cloud.center = pos;
            break;

        case ekSEGMENT:
            shape->body.seg.center = pos;
            col2dhello_update_seg(&shape->body.seg);
            break;

        case ekCIRCLE:
            shape->body.cir.c = pos;
            break;

        case ekBOX:
            shape->body.box.center = pos;
            col2dhello_update_box(&shape->body.box);
            break;

        case ekOBB:
            shape->body.obb.center = pos;
            col2dhello_update_obb(&shape->body.obb);
            break;

        case ekTRIANGLE:
            shape->body.tri.center = pos;
            col2dhello_update_tri(&shape->body.tri);
            break;

        case ekCONVEX_POLY:
        case ekSIMPLE_POLY:
            shape->body.pol.center = pos;
            col2dhello_update_pol(&shape->body.pol);
            break;

        cassert_default();
    }
}

/*-----*/

static void i_OnDown(App *app, Event *e)
{

```

```

uint32_t selshape = UINT32_MAX;
arrst_foreach(shape, app->shapes, Shape)
    if (shape->mouse == TRUE)
    {
        selshape = shape_i;
        break;
    }
arrst_end()

if (selshape != app->selshape)
{
    View *view = event_sender(e, View);
    app->selshape = selshape;
    col2dhello_dbind_shape(app);
    view_update(view);
}

if (app->selshape != UINT32_MAX)
{
    const EvMouse *p = event_params(e, EvMouse);
    const Shape *shape = arrst_get(app->shapes, app->selshape, Shape);
    app->mouse_pos.x = p->x;
    app->mouse_pos.y = p->y;
    i_get_shape_pos(shape, &app->obj_pos);
}
}

/*-----*/

static void i_OnDrag(App *app, Event *e)
{
    if (app->selshape != UINT32_MAX)
    {
        const EvMouse *p = event_params(e, EvMouse);
        Shape *shape = arrst_get(app->shapes, app->selshape, Shape);
        V2Df move = v2df(app->obj_pos.x + (p->x - app->mouse_pos.x), app->
            ↪ obj_pos.y + (p->y - app->mouse_pos.y));
        i_set_shape_pos(shape, move);
        col2dhello_collisions(app);
        view_update(app->view);
    }
}

/*-----*/

static void i_OnAcceptFocus(App *app, Event *e)
{
    bool_t *r = event_result(e, bool_t);
    unref(app);
    *r = FALSE;
}

```

```

/*-----*/

static Layout *i_layout(App *app)
{
    Layout *layout1 = layout_create(2, 1);
    Layout *layout2 = i_left_layout(app);
    View *view = view_create();
    view_size(view, s2df(640, 580));
    view_OnDraw(view, listener(app, i_OnDraw, App));
    view_OnMove(view, listener(app, i_OnMove, App));
    view_OnDown(view, listener(app, i_OnDown, App));
    view_OnDrag(view, listener(app, i_OnDrag, App));
    view_OnAcceptFocus(view, listener(app, i_OnAcceptFocus, App));
    layout_layout(layout1, layout2, 0, 0);
    layout_view(layout1, view, 1, 0);
    layout_valign(layout1, 0, 0, ekTOP);
    layout_hexpand(layout1, 1);
    app->view = view;
    return layout1;
}

/*-----*/

Window *col2dhello_window(App *app)
{
    Panel *panel = panel_create();
    Layout *layout = i_layout(app);
    Window *window = window_create(ekWINDOW_STDRES);
    panel_layout(panel, layout);
    window_panel(window, panel);
    return window;
}

/*-----*/

void col2dhello_dbind_shape(App *app)
{
    if (app->selshape != UINT32_MAX)
    {
        Shape *shape = arrst_get(app->shapes, app->selshape, Shape);
        switch (shape->type)
        {
            case ekPOINT:
                panel_visible_layout(app->obj_panel, 1);
                app->sel_area = 0;
                break;

            case ekPOINT_CLOUD:
                layout_dbind_obj(app->cld_layout, &shape->body.cloud, Cloud);
                panel_visible_layout(app->obj_panel, 2);
        }
    }
}

```

```

        app->sel_area = 0;
        break;

    case ekSEGMENT:
        layout_dbind_obj(app->seg_layout, &shape->body.seg, Seg);
        panel_visible_layout(app->obj_panel, 3);
        app->sel_area = 0;
        break;

    case ekCIRCLE:
        layout_dbind_obj(app->cir_layout, &shape->body.cir, Cir2Df);
        panel_visible_layout(app->obj_panel, 4);
        app->sel_area = cir2d_areaf(&shape->body.cir);
        break;

    case ekBOX:
        layout_dbind_obj(app->box_layout, &shape->body.box, Box);
        panel_visible_layout(app->obj_panel, 5);
        break;

    case ekOBB:
        layout_dbind_obj(app->obb_layout, &shape->body.obb, OBB);
        panel_visible_layout(app->obj_panel, 6);
        break;

    case ekTRIANGLE:
        layout_dbind_obj(app->tri_layout, &shape->body.tri, Tri);
        panel_visible_layout(app->obj_panel, 7);
        break;

    case ekCONVEX_POLY:
    case ekSIMPLE_POLY:
        layout_dbind_obj(app->pol_layout, &shape->body.pol, Pol);
        panel_visible_layout(app->obj_panel, 8);
        break;

        cassert_default();
    }
}
else
{
    layout_dbind_obj(app->cld_layout, NULL, Cloud);
    layout_dbind_obj(app->seg_layout, NULL, Seg);
    layout_dbind_obj(app->cir_layout, NULL, Cir2Df);
    layout_dbind_obj(app->box_layout, NULL, Box);
    layout_dbind_obj(app->obb_layout, NULL, OBB);
    layout_dbind_obj(app->tri_layout, NULL, Tri);
    layout_dbind_obj(app->pol_layout, NULL, Pol);
    panel_visible_layout(app->obj_panel, 0);
}

```



```
col2dhello_update_gui(app);  
}
```

Drawing on an image

32.1 Drawing on an image

721

32.1. Drawing on an image

In this example we see how to generate vector graphics in two different contexts using the same drawing code (Figure 32.1). On the left side we render directly into the window through a `View` control. On the right side generate an image using different resolutions. To show it we use a `ImageView` control configured to stretch the image in case it is smaller than the control itself, which makes clear the loss of quality. The **source code** is in folder `/demo/drawing` of the SDK distribution.

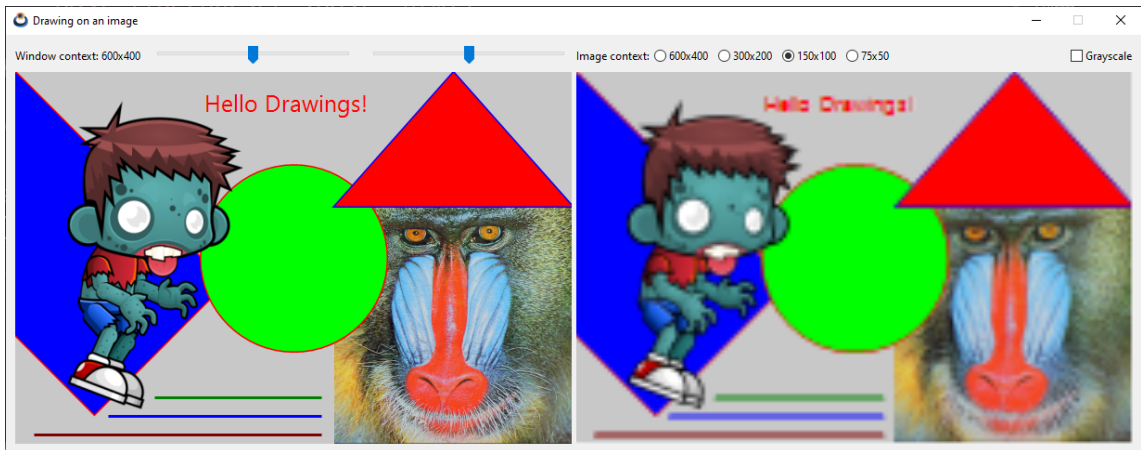

Figure 32.1: 2D Contexts: Window (left), Image (right).

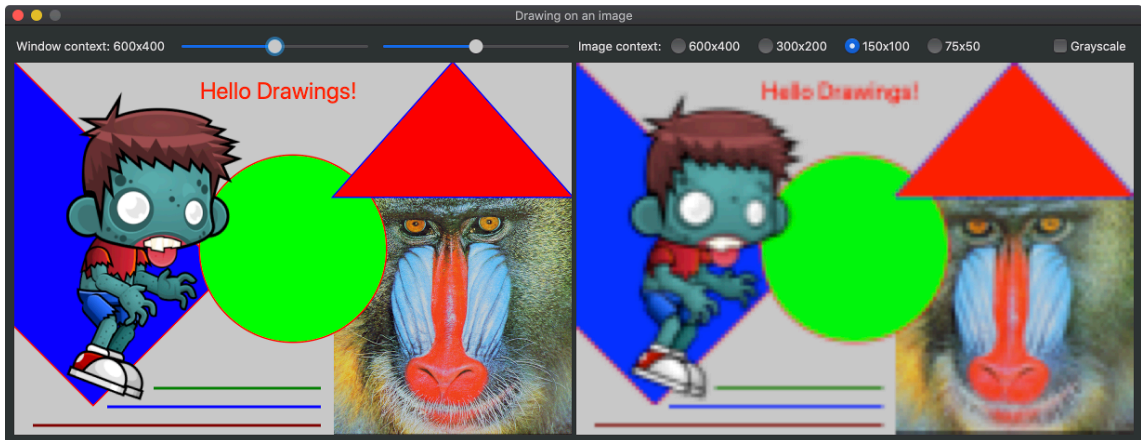

Figure 32.2: macOS version.

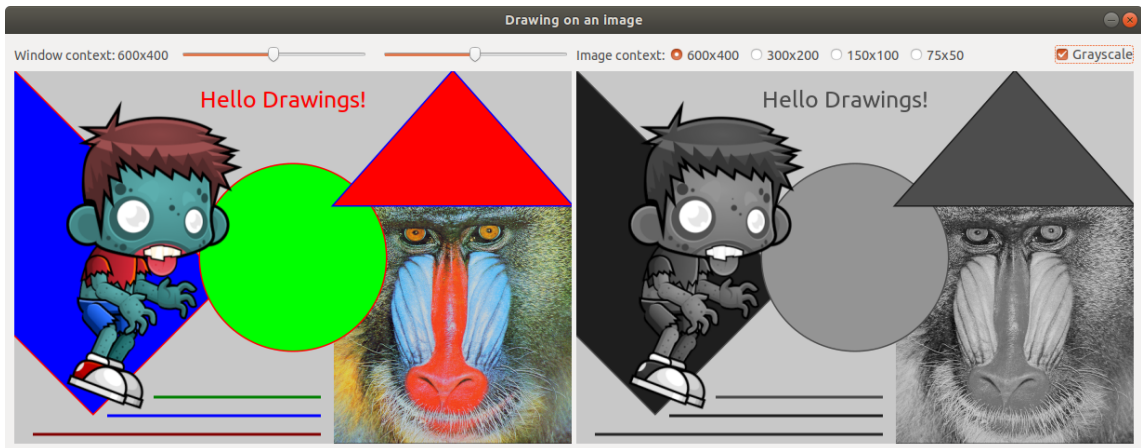

Figure 32.3: Linux version.

Listing 32.1: demo/drawing/drawing.c

```

/* Drawing on an image */

#include "res_drawing.h"
#include <nappgui.h>

typedef struct _app_t App;

struct _app_t
{
    Window *window;
    Window *expwin;
    Font *font;
    View *view;
}

```

```

    ImageView *iview;
    uint32_t res;
    real32_t angle;
    real32_t scale;
    String *exp_path;
    codec_t exp_codec;
    uint32_t exp_bpp;
    bool_t exp_alpha;
};

static uint32_t i_WIDTH[4] = {600, 300, 150, 75};
static uint32_t i_HEIGHT[4] = {400, 200, 100, 50};
static real32_t i_SCALE[4] = {1, .5f, .25f, .125f};

/*-----*/

static void i_draw(DCtx *ctx, const T2Df *t2d_global, const Font *font)
{
    T2Df t2d_object;
    V2Df triangle[] = { {472,0}, {600,144}, {344,144} };
    const Image *image1 = gui_image(MONKEY_GIF);
    const Image *image2 = gui_image(ZOMBIE_PNG);
    t2d_scalef(&t2d_object, t2d_global, .5f, .5f);
    draw_matrixf(ctx, &t2d_object);
    draw_image(ctx, image1, 688, 288);
    draw_line_color(ctx, color_rgb(255, 0, 0));
    draw_line_width(ctx, 3);
    draw_fill_color(ctx, color_rgb(0, 0, 255));
    t2d_rotatef(&t2d_object, t2d_global, kBMATH_PIf / 4);
    draw_matrixf(ctx, &t2d_object);
    draw_rect(ctx, ekSKFILL, 0, 0, 320, 200);
    draw_fill_color(ctx, color_rgb(0, 255, 0));
    draw_matrixf(ctx, t2d_global);
    draw_circle(ctx, ekSKFILL, 300, 200, 100);
    draw_line_color(ctx, color_rgb(0, 0, 255));
    draw_fill_color(ctx, color_rgb(255, 0, 0));
    draw_polygon(ctx, ekSKFILL, triangle, 3);
    t2d_scalef(&t2d_object, t2d_global, .7f, .7f);
    draw_matrixf(ctx, &t2d_object);
    draw_image(ctx, image2, 0, 0);
    draw_font(ctx, font);
    draw_matrixf(ctx, t2d_global);
    draw_text_color(ctx, color_rgb(255, 0, 0));
    draw_text(ctx, "Hello Drawings!", 200, 15);
    draw_line_color(ctx, color_rgb(0, 128, 0));
    draw_line(ctx, 150, 350, 330, 350);
    draw_line_color(ctx, color_rgb(0, 0, 255));
    draw_line(ctx, 100, 370, 330, 370);
    draw_line_color(ctx, color_rgb(128, 0, 0));
    draw_line(ctx, 20, 390, 330, 390);
}

```

```

/*-----*/

static void i_OnDraw(App *app, Event *e)
{
    T2Df t2d;
    const EvDraw *p = event_params(e, EvDraw);
    t2d_rotatef(&t2d, kT2D_IDENTf, app->angle);
    t2d_scalef(&t2d, &t2d, app->scale, 1);
    draw_clear(p->ctx, color_rgb(200, 200, 200));
    i_draw(p->ctx, &t2d, app->font);
}

/*-----*/

static void i_draw_img(App *app)
{
    T2Df t2d;
    DCtx *ctx = dctx_bitmap(i_WIDTH[app->res], i_HEIGHT[app->res], ekRGB24);
    Image *image;
    t2d_scalef(&t2d, kT2D_IDENTf, i_SCALE[app->res], i_SCALE[app->res]);
    draw_clear(ctx, color_rgb(200, 200, 200));
    i_draw(ctx, &t2d, app->font);
    image = dctx_image(&ctx);
    imageview_image(app->iview, image);
    image_destroy(&image);
}

/*-----*/

static void i_OnResolution(App *app, Event *e)
{
    const EvButton *p = event_params(e, EvButton);
    app->res = p->index;
    i_draw_img(app);
}

/*-----*/

static Layout *i_filename_layout(void)
{
    Layout *layout = layout_create(2, 1);
    Edit *edit = edit_create();
    Button *button = button_push();
    button_text(button, "Open");
    layout_edit(layout, edit, 0, 0);
    layout_button(layout, button, 1, 0);
    return layout;
}

/*-----*/

```

```

static Layout *i_bpp_layout(void)
{
    Layout *layout = layout_create(1, 5);
    Button *button1 = button_radio();
    Button *button2 = button_radio();
    Button *button3 = button_radio();
    Button *button4 = button_radio();
    Button *button5 = button_radio();
    button_text(button1, "1 bpp (2 colors)");
    button_text(button2, "2 bpp (4 colors)");
    button_text(button3, "4 bpp (16 colors)");
    button_text(button4, "8 bpp (32 colors)");
    button_text(button5, "RGB (True color)");
    layout_button(layout, button1, 0, 0);
    layout_button(layout, button2, 0, 1);
    layout_button(layout, button3, 0, 2);
    layout_button(layout, button4, 0, 3);
    layout_button(layout, button5, 0, 4);
    return layout;
}

/*-----*/

static void i_OnOk(App *app, Event *e)
{
    window_stop_modal(app->expwin, 1);
    unref(e);
}

/*-----*/

static void i_OnCancel(App *app, Event *e)
{
    window_stop_modal(app->expwin, 0);
    unref(e);
}

/*-----*/

static Window *i_export_window(App *app)
{
    Window *window = window_create(ekWINDOW_TITLE | ekWINDOW_CLOSE);
    Panel *panel = panel_create();
    Layout *layout1 = layout_create(3, 4);
    Layout *layout2 = i_filename_layout();
    Layout *layout3 = i_bpp_layout();
    Label *label1 = label_create();
    Label *label2 = label_create();
    Label *label3 = label_create();
    Label *label4 = label_create();
}

```

```

PopUp *popup = popup_create();
Button *button1 = button_check();
Button *button2 = button_push();
Button *button3 = button_push();
label_text(label1, "File name:");
label_text(label2, "Format:");
label_text(label3, "Pixel Depth (bpp):");
label_text(label4, "Transparent background:");
button_text(button2, "Ok");
button_text(button3, "Cancel");
button_OnClick(button2, listener(app, i_OnOk, App));
button_OnClick(button3, listener(app, i_OnCancel, App));
layout_label(layout1, label1, 0, 0);
layout_label(layout1, label2, 0, 1);
layout_label(layout1, label3, 0, 2);
layout_label(layout1, label4, 0, 3);
layout_layout(layout1, layout2, 1, 0);
layout_popup(layout1, popup, 1, 1);
layout_layout(layout1, layout3, 1, 2);
layout_button(layout1, button1, 1, 3);
layout_button(layout1, button2, 2, 0);
layout_button(layout1, button3, 2, 1);
panel_layout(panel, layout1);
window_panel(window, panel);
window_title(window, "Image export");
return window;
}

/*-----*/

static void i_export_png(void)
{
    const uint32_t w = 640, h = 400;
    uint32_t i, j, wi = w / 4;
    Palette *palette = palette_create(4);
    Pixbuf *pixbuf = pixbuf_create(w, h, ekINDEX2);
    color_t *c = palette_colors(palette);
    Image *image = NULL;
    c[0] = color_rgba(255, 0, 0, 255);
    c[1] = color_rgba(0, 255, 0, 170);
    c[2] = color_rgba(0, 0, 255, 85);
    c[3] = color_rgba(255, 255, 255, 1);
    for (i = 0; i < w; ++i)
    {
        uint32_t idx = 3;
        if (i < wi)
            idx = 0;
        else if (i < 2 * wi)
            idx = 1;
        else if (i < 3 * wi)
            idx = 2;
    }
}

```

```

        for (j = 0; j < h; ++j)
            pixbuf_set(pixbuf, i, j, idx);
    }

    image = image_from_pixbuf(pixbuf, palette);
    image_codec(image, ekGIF);
    image_to_file(image, "/home/fran/Desktop/export.gif", NULL);
    pixbuf_destroy(&pixbuf);
    palette_destroy(&palette);
    image_destroy(&image);

    {
        Image *img = image_from_file("/home/fran/Desktop/country.jpg", NULL);
        image_codec(img, ekGIF);
        image_to_file(img, "/home/fran/Desktop/country.gif", NULL);
        image_destroy(&img);
    }
}

/*-----*/

static void i_OnExport(App *app, Event *e)
{
    V2Df p0, p1;
    S2Df s0, s1;
    uint32_t res = 0;
    unref(e);
    app->expwin = i_export_window(app);
    p0 = window_get_origin(app->window);
    s0 = window_get_size(app->window);
    s1 = window_get_size(app->expwin);
    p1 = v2df(p0.x + (s0.width - s1.width) / 2, p0.y + (s0.height - s1.height)
    ↪ / 2);
    window_origin(app->expwin, p1);
    res = window_modal(app->expwin, app->window);

    if (res == 1)
    {
        i_export_png();
    }

    window_destroy(&app->expwin);
}

/*-----*/

static Layout *i_img_layout(App *app)
{
    Layout *layout = layout_create(7, 1);
    Label *label = label_create();

```



```

    Button *button1 = button_radio();
    Button *button2 = button_radio();
    Button *button3 = button_radio();
    Button *button4 = button_radio();
    Button *button5 = button_push();
    label_text(label, "Image context:");
    button_text(button1, "600x400");
    button_text(button2, "300x200");
    button_text(button3, "150x100");
    button_text(button4, "75x50");
    button_text(button5, "Export...");
    button_state(button1, ekGUI_ON);
    button_OnClick(button1, listener(app, i_OnResolution, App));
    button_OnClick(button5, listener(app, i_OnExport, App));
    layout_label(layout, label, 0, 0);
    layout_button(layout, button1, 1, 0);
    layout_button(layout, button2, 2, 0);
    layout_button(layout, button3, 3, 0);
    layout_button(layout, button4, 4, 0);
    layout_button(layout, button5, 6, 0);
    layout_hmargin(layout, 0, 5);
    layout_hmargin(layout, 1, 10);
    layout_hmargin(layout, 2, 10);
    layout_hmargin(layout, 3, 10);
    layout_hexpand(layout, 5);
    return layout;
}

/*-----*/

static void i_OnAngle(App *app, Event *e)
{
    const EvSlider *p = event_params(e, EvSlider);
    app->angle = (p->pos - .5f) * kBMATH_PIF;
    view_update(app->view);
}

/*-----*/

static void i_OnScale(App *app, Event *e)
{
    const EvSlider *p = event_params(e, EvSlider);
    app->scale = p->pos + .5f;
    view_update(app->view);
}

/*-----*/

static Layout *i_win_layout(App *app)
{
    Layout *layout = layout_create(5, 1);

```

```

Label *label1 = label_create();
Label *label2 = label_create();
Label *label3 = label_create();
Slider *slider1 = slider_create();
Slider *slider2 = slider_create();
label_text(label1, "Window context: 600x400");
label_text(label2, "Angle:");
label_text(label3, "Scale:");
slider_value(slider1, .5f);
slider_value(slider2, .5f);
slider_OnMoved(slider1, listener(app, i_OnAngle, App));
slider_OnMoved(slider2, listener(app, i_OnScale, App));
layout_label(layout, label1, 0, 0);
layout_label(layout, label2, 1, 0);
layout_label(layout, label3, 3, 0);
layout_slider(layout, slider1, 2, 0);
layout_slider(layout, slider2, 4, 0);
layout_hmargin(layout, 0, 10);
layout_hmargin(layout, 2, 10);
layout_hexpand2(layout, 2, 4, .5f);
return layout;
}

/*-----*/

static Panel *i_panel(App *app)
{
    Panel *panel = panel_create();
    Layout *layout1 = layout_create(2, 2);
    Layout *layout2 = i_win_layout(app);
    Layout *layout3 = i_img_layout(app);
    View *view = view_create();
    ImageView *iview = imageview_create();
    view_size(view, s2df(600, 400));
    imageview_size(iview, s2df(600, 400));
    view_OnDraw(view, listener(app, i_OnDraw, App));
    imageview_scale(iview, eKGUI_SCALE_ASPECT);
    layout_layout(layout1, layout2, 0, 0);
    layout_view(layout1, view, 0, 1);
    layout_imageview(layout1, iview, 1, 1);
    layout_layout(layout1, layout3, 1, 0);
    layout_margin(layout1, 10);
    layout_hmargin(layout1, 0, 5);
    layout_vmargint(layout1, 0, 5);
    panel_layout(panel, layout1);
    app->view = view;
    app->iview = iview;
    return panel;
}

/*-----*/

```

```

static void i_OnClose(App *app, Event *e)
{
    osapp_finish();
    unref(app);
    unref(e);
}

/*-----*/

static App *i_create(void)
{
    App *app = heap_new0(App);
    Panel *panel = i_panel(app);
    gui_repack(res_drawing_repack);
    gui_language("");
    app->window = window_create(ekWINDOW_STD);
    app->font = font_system(25.f, 0);
    app->res = 0;
    app->angle = 0;
    app->scale = 1;
    i_draw_img(app);
    window_panel(app->window, panel);
    window_title(app->window, "Drawing on an image");
    window_origin(app->window, v2df(500, 200));
    window_OnClose(app->window, listener(app, i_OnClose, App));
    window_show(app->window);
    return app;
}

/*-----*/

static void i_destroy(App **app)
{
    window_destroy(&(*app)->window);
    font_destroy(&(*app)->font);
    heap_delete(app, App);
}

/*-----*/

#include "osmain.h"
osmain(i_create, i_destroy, "", App)

```

DrawBig

33.1	DrawBig	731
33.2	DrawBig layout	731
33.3	DrawBig expansion	734
33.4	Drawing view in DrawBig	735
33.5	DrawBig overlay	736
33.6	DrawBig multilayout	737
33.7	DrawBig animations	738
33.8	Layout coloring in DrawBig	739
33.9	DrawBig overlapping windows	740
33.10	DrawBig source code	741

33.1. DrawBig

In this example we present an application that can serve as a basis for different projects. It consists of a generic viewer with scroll, which allows navigation between a multitude of items (Figure 33.1), (Figure 33.2), (Figure 33.3). On both sides we have several list boxes and a table. At the top we have different controls as a toolbar and, at the bottom, status information.

33.2. DrawBig layout

In (Figure 33.4) we have the layout of the window. The space is divided into three rows (controls, middle part and info). The middle part, in turn, is divided into three horizontal cells (lists, view and table).

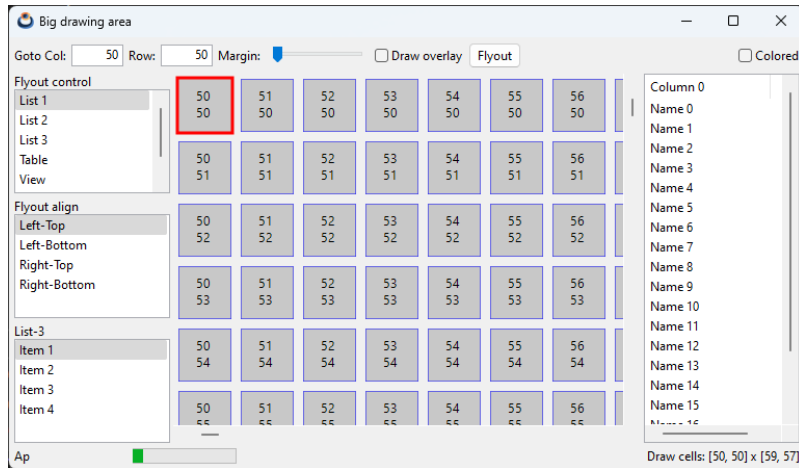

Figure 33.1: DrawBig Windows version.



Figure 33.2: DrawBig macOS version.

Main skeleton of the layout.

```
static Layout *i_multi_layout(App *app)
{
    Layout *layout1 = layout_create(1, 3);
    Layout *layout2 = i_control_layout(app);
    Layout *layout3 = i_middle_layout(app);
    Layout *layout4 = i_info_layout(app);
}
...
static Layout *i_control_layout(App *app)
{
    Layout *layout = layout_create(10, 1);
```

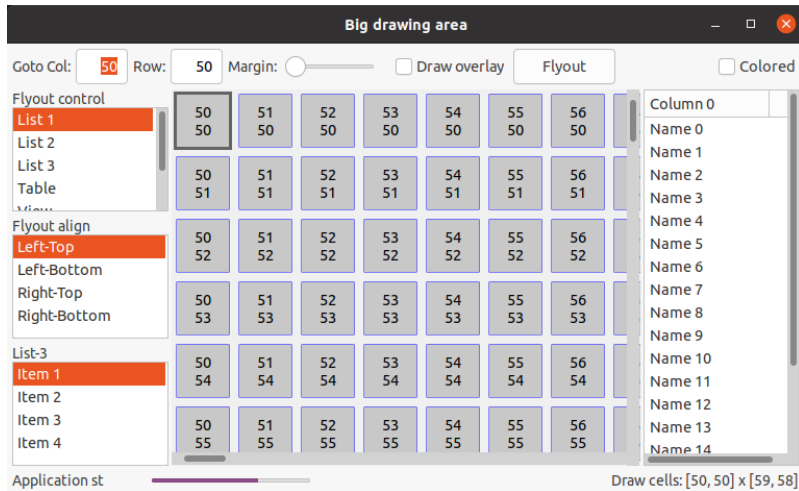

Figure 33.3: DrawBig Linux version.

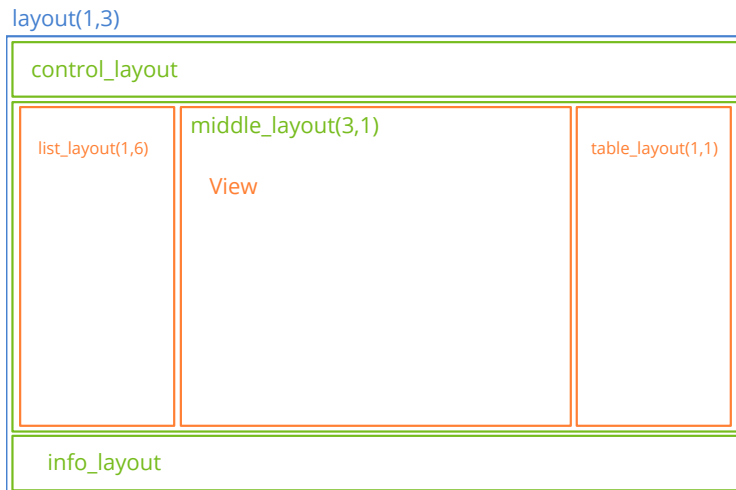

Figure 33.4: DrawBig layout.

```

}
...
static Layout *i_middle_layout(App *app)
{
    Layout *layout1 = layout_create(3, 1);
    Layout *layout2 = i_list_layout(app);
    Layout *layout3 = i_table_layout(app);
    View *view = view_scroll();
}
...
static Layout *i_info_layout(App *app)

```

```

{
    Layout *layout = layout_create(4, 1);
}
...
static Layout *i_list_layout(App *app)
{
    Layout *layout = layout_create(1, 6);
}
...
static Layout *i_table_layout(App *app)
{
    Layout *layout = layout_create(1, 1);
}

```

33.3. DrawBig expansion

The application allows the resizing/maximization of the window, so it is necessary to explain how the different cells will grow (Figure 33.5). The vertical expansion will fall 100% on *middle_layout*, leaving *control_layout* and *info_layout* with a constant height. Within the central layout, both the view and the table will expand vertically to 100% as well. However, on the left side, the expansion will be distributed among the three lists at 33% for each one. Speaking of horizontal expansion, it will be done 100% on the drawing view in *middle_layout*, leaving the lists and table with a constant width. In *control_layout* and *info_layout* two empty cells will be expanded horizontally, in such a way that allows certain controls (checkbox, label) to remain aligned to the right of the window.

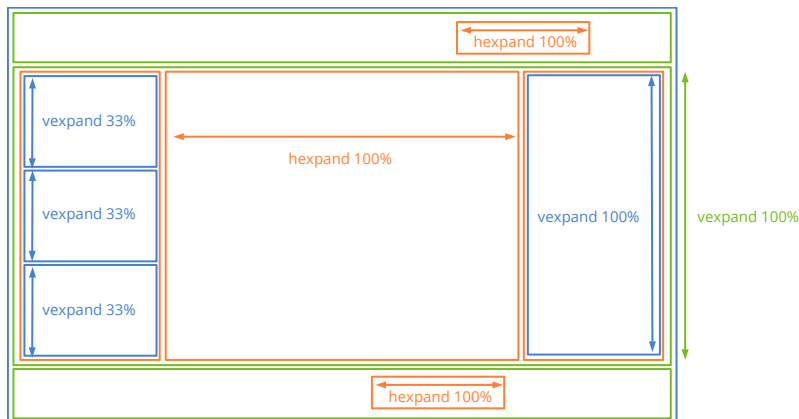

Figure 33.5: Expanding cells in DrawBig.

```

static Layout *i_multi_layout(App *app)
{
    ...
    /* All the vertical expansion will be done in the middle layout

```

```

        control_layout (top) and info_layout (bottom) will preserve the 'natural
        ↪ ' height */
    layout_vexpand(layout1, 1);
    ...
}
...
static Layout *i_list_layout(App *app)
{
    ...
    /* The vertical expansion will be distributed equally between listboxes */
    layout_vexpand3(layout, 1, 3, 5, .33f, .33f);
    ...
}
...
static Layout *i_control_layout(App *app)
{
    ...
    /* All the horizontal expansion will be done in an empty cell between
    * 'Colored' checkbox and 'Flyout' button */
    layout_hexpand(layout, 8);
    ...
}
...
static Layout *i_info_layout(App *app)
{
    ...
    /* All the horizontal expansion will be done in empty column-cell(2) */
    layout_hexpand(layout, 2);
    ...
}
...
static Layout *i_middle_layout(App *app)
{
    /* All the horizontal expansion will be done in the middle cell (view)
    list_layout (left) and table_layout (right) will preserve the 'natural'
    ↪ width */
    layout_hexpand(layout1, 1);
}

```

33.4. Drawing view in DrawBig

The central view shows how to manage a very large drawing area, of which only a small portion is visible (Figure 33.6). We will represent a grid of 2000x2000 cells, using a `View` control with scroll bars. In this example we have delved into:

- Optimize the `OnDraw` event to draw only the visible area, avoiding launching unnecessary graphic commands.
- Size scroll bars with `view_content_size`.



Figure 33.6: Main view in DrawBig.

- Move the visible area using `view_scroll_x`, `view_scroll_y`.
- Get the visible area with `view_viewport`.
- Use of the mouse: Being able to click on a cell or highlight it when the cursor is over it.
- Keyboard usage: Allow the view to capture focus and move the active element with the [Left], [Right], [Up] and [Down] keys. Keyboard navigation requires that this element always be visible.

33.5. DrawBig overlay

An overlay is a graphic layer that is drawn over the main content (Figure 33.7). They are especially useful in scrolling views, since they use the control reference system $(0, 0)$ - (left, top), without taking into account the displacement of the drawing context due to the scroll bars.

```
static void i_OnOverlay(App *app, Event *e)
{
    const EvDraw *p = event_params(e, EvDraw);
    cassert_no_null(app);
    if (app->overlay == TRUE)
    {
        draw_fill_color(p->ctx, KCOLOR_BLACK);
    }
}
```

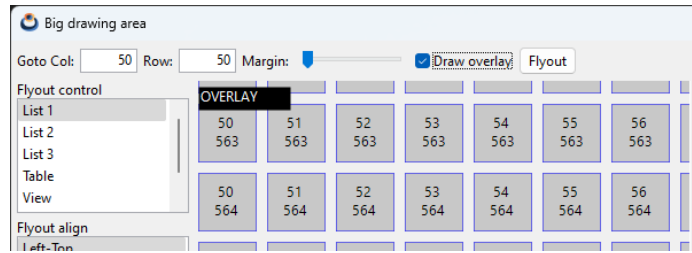

Figure 33.7: DrawBig overlays.

```

        draw_text_color(p->ctx, kCOLOR_WHITE);
        draw_rect(p->ctx, ekFILL, 5, 5, 80, 20);
        draw_text(p->ctx, "OVERLAY", 5, 5);
    }
}
...
view_OnOverlay(view, listener(app, i_OnOverlay, App));

```

33.6. DrawBig multilayout

When we navigate through the central view, if we press the [RETURN] key the window content will change to show an enlarged view of the selected element (Figure 33.8). This is achieved by associating two different layouts with the main panel and switching between them at runtime.

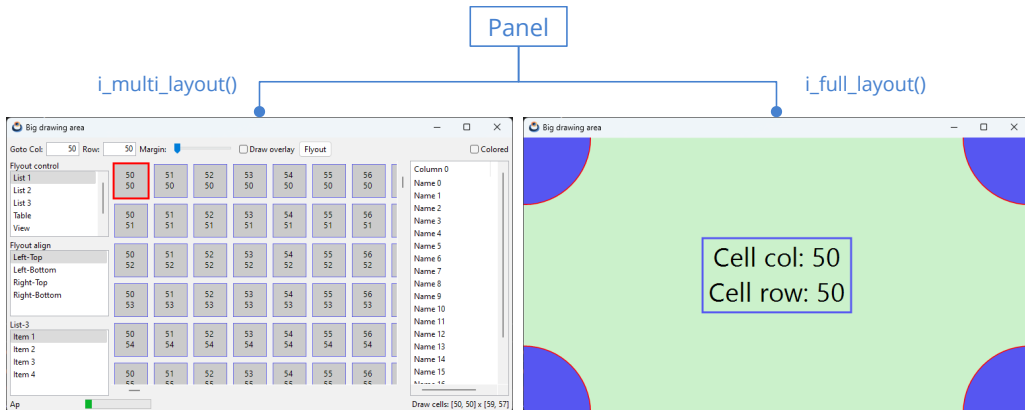

Figure 33.8: Panel with two layouts in DrawBig.

```

static Panel *i_panel(App *app)
{
    Panel *panel = panel_create();
    Layout *layout1 = i_multi_layout(app);
    Layout *layout2 = i_full_layout(app);
    panel_layout(panel, layout1);
    panel_layout(panel, layout2);
}

```

```

...
}
...
if (p->key == ekKEY_RETURN)
{
    panel_visible_layout(app->panel, 1);
    panel_update(app->panel);
    window_focus(app->window, guicontrol(app->fullview));
}

```

33.7. DrawBig animations

The bottom status bar shows a small animation of a text field and a progress bar (Figure 33.9). The state of the animation should be controlled in the `i_update()` method of `osmain_sync`. More information in “*Synchronous applications*” (page 397).

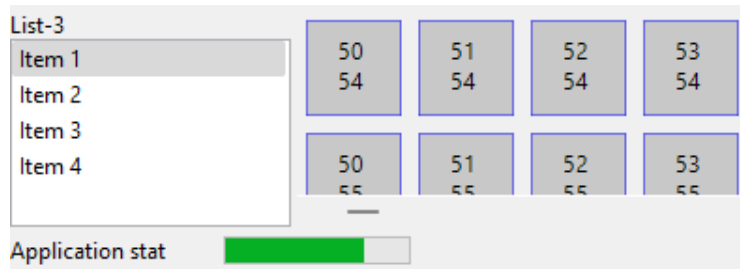

Figure 33.9: Animation of GUI elements. animation in https://nappgui.com/img/howto/drawbig_anim.gif.

```

static void i_update(App *app, const real64_t prtime, const real64_t ctime)
{
    char_t text[128];
    unref(prtime);
    unref(ctime);
    str_copy_cn(text, sizeof(text), i_STATUS_TEXT, app->anim_frame);
    label_text(app->status_label, text);
    progress_value(app->progress, (real32_t)app->anim_frame / (real32_t)app->
        ↪ anim_total);
    app->anim_frame += 1;
    if (app->anim_frame > app->anim_total)
        app->anim_frame = 0;
}
...
#include "osmain.h"
osmain_sync(0.1, i_create, i_destroy, i_update, "", App)

```

33.8. Layout coloring in DrawBig

DrawBig has a checkbox with which we can activate the coloring of layouts (Figure 33.10). In this way we can check the limits and margins in the final composition of the window.



Figure 33.10: Coloring of layouts in DrawBig.

```
static void i_OnColored(App *app, Event *e)
{
    const EvButton *p = event_params(e, EvButton);
    if (p->state == ekGUI_ON)
    {
        layout_bgcolor(app->main_layout, color_rgb(128, 0, 0));
        layout_bgcolor(app->middle_layout, color_rgb(0, 128, 0));
        layout_bgcolor(app->control_layout, color_rgb(0, 0, 128));
        layout_bgcolor(app->info_layout, color_rgb(128, 128, 0));
    }
    else
    {
        layout_bgcolor(app->main_layout, kCOLOR_DEFAULT);
        layout_bgcolor(app->middle_layout, kCOLOR_DEFAULT);
        layout_bgcolor(app->control_layout, kCOLOR_DEFAULT);
        layout_bgcolor(app->info_layout, kCOLOR_DEFAULT);
    }

    panel_update(app->panel);
}
```

33.9. DrawBig overlapping windows

Finally, DrawBig allows you to launch an overlay window, with additional controls, which is deactivated when you press [ESC], [RETURN] or click on the main window (Figure 33.11). This window has been created without a frame or title bar and can be aligned with respect to any interior control.



Figure 33.11: Overlay window in DrawBig.

```
static void i_flyout_over_control(App *app, GuiControl *control, const uint32_t
    ↪ align)
{
    /* Control bounds in window coordinates */
    R2Df frame = window_control_frame(app->window, control);
    /* Top-Left control in screen coordinates */
    V2Df pos = window_client_to_screen(app->window, frame.pos);
    /* Flyout window size */
    S2Df size = window_get_size(app->flyout);

    switch (align) {
    case 0:
        break;
    case 1:
        pos.y += (frame.size.height - size.height);
        break;
    case 2:
        pos.x += (frame.size.width - size.width);
        break;
    case 3:
        pos.x += (frame.size.width - size.width);
        pos.y += (frame.size.height - size.height);
        break;
    }
}
```

```

    /* Position in screen coordinates */
    window_origin(app->flyout, pos);
    window_overlay(app->flyout, app->window);
}

```

33.10. DrawBig source code

Listing 33.1: demo/drawbig/drawbig.c

```

/* Drawing a big area with scrollbars */

#include <nappgui.h>

typedef struct _app_t App;

struct _app_t
{
    Window *window;
    Window *flyout;
    Panel *panel;
    ListBox *list1;
    ListBox *list2;
    ListBox *list3;
    TableView *table;
    Edit *edit1;
    Edit *edit2;
    View *view;
    View *fullview;
    Label *cells_label;
    Label *status_label;
    Progress *progress;
    uint32_t col_id;
    uint32_t row_id;
    uint32_t margin;
    uint32_t mouse_cell_x;
    uint32_t mouse_cell_y;
    uint32_t sel_cell_x;
    uint32_t sel_cell_y;
    bool_t focus;
    bool_t overlay;
    Layout *main_layout;
    Layout *middle_layout;
    Layout *control_layout;
    Layout *info_layout;
    char_t temptxt[256];
    uint32_t anim_frame;
    uint32_t anim_total;
    Font *fullfont;
    color_t drawcolor;
    color_t backcolor;
}

```

```

};

static const uint32_t i_NUM_COLS = 2000;
static const uint32_t i_NUM_ROWS = 2000;
static const real32_t i_CELL_SIZE = 50;
static const char_t *i_CELLS_INFO = "Draw cells: [%d, %d] x [%d, %d]";
static const char_t *i_STATUS_TEXT = "Application status...";

/*-----*/

static void i_dbind(void)
{
    dbind(App, uint32_t, col_id);
    dbind(App, uint32_t, row_id);
    dbind(App, uint32_t, margin);
    dbind(App, bool_t, overlay);
    dbind_range(App, uint32_t, col_id, 0, i_NUM_COLS - 1);
    dbind_range(App, uint32_t, row_id, 0, i_NUM_ROWS - 1);
    dbind_range(App, uint32_t, margin, 10, 50);
}

/*-----*/

static void i_content_size(App *app)
{
    real32_t width = i_NUM_COLS * i_CELL_SIZE + (i_NUM_COLS + 1) * app->margin;
    real32_t height = i_NUM_ROWS * i_CELL_SIZE + (i_NUM_ROWS + 1) * app->margin
    ↪ ;
    view_content_size(app->view, s2df((real32_t)width, (real32_t)height), s2df
    ↪ (10, 10));
}

/*-----*/

static void i_scroll_to_cell(App *app)
{
    real32_t xpos = app->col_id * i_CELL_SIZE + (app->col_id + 1) * app->margin
    ↪ ;
    real32_t ypos = app->row_id * i_CELL_SIZE + (app->row_id + 1) * app->margin
    ↪ ;
    xpos -= 5;
    ypos -= 5;
    view_scroll_x(app->view, xpos);
    view_scroll_y(app->view, ypos);
}

/*-----*/

static void i_draw_clipped(App *app, DCtx *ctx, const real32_t x, const
    ↪ real32_t y, const real32_t width, const real32_t height)
{

```

```

uint32_t sti, edi;
uint32_t stj, edj;
real32_t cellsize = i_CELL_SIZE + (real32_t)app->margin;
real32_t hcell = i_CELL_SIZE / 2;
real32_t posx = 0;
real32_t posy = 0;
uint32_t i, j;

/* Calculate the visible cols */
sti = (uint32_t)bmath_floorf(x / cellsize);
edi = sti + (uint32_t)bmath_ceilf(width / cellsize) + 1;
if (edi > i_NUM_COLS)
    edi = i_NUM_COLS;

/* Calculate the visible rows */
stj = (uint32_t)bmath_floorf(y / cellsize);
edj = stj + (uint32_t)bmath_ceilf(height / cellsize) + 1;
if (edj > i_NUM_ROWS)
    edj = i_NUM_ROWS;

posy = (real32_t)app->margin + stj * cellsize;

{
    char_t text[256];
    bstd_sprintf(text, sizeof(text), i_CELLS_INFO, sti, stj, edi, edj);
    label_text(app->cells_label, text);
}

draw_fill_color(ctx, color_gray(240));
draw_rect(ctx, ekFILL, x, y, width, height);
draw_fill_color(ctx, color_gray(200));
draw_line_color(ctx, kCOLOR_BLUE);
draw_line_width(ctx, 1);
draw_text_align(ctx, ekCENTER, ekCENTER);
draw_text_halign(ctx, ekCENTER);

for (j = stj; j < edj; ++j)
{
    posx = (real32_t)app->margin + sti * cellsize;
    for (i = sti; i < edi; ++i)
    {
        char_t text[128];
        bool_t special_cell = FALSE;

        bstd_sprintf(text, sizeof(text), "%d\n%d", i, j);

        if (app->sel_cell_x == i && app->sel_cell_y == j)
        {
            draw_line_width(ctx, 6);
            if (app->focus == TRUE)
                draw_line_color(ctx, kCOLOR_RED);
        }
    }
}

```



```

        else
            draw_line_color(ctx, color_gray(100));

            special_cell = TRUE;
        }
        else if (app->mouse_cell_x == i && app->mouse_cell_y == j)
        {
            draw_line_width(ctx, 3);
            draw_line_color(ctx, kCOLOR_BLUE);
            special_cell = TRUE;
        }

        draw_rect(ctx, ekSKFILL, posx, posy, i_CELL_SIZE, i_CELL_SIZE);
        draw_text(ctx, text, posx + hcell, posy + hcell);

        if (special_cell == TRUE)
        {
            draw_line_width(ctx, 1);
            draw_line_color(ctx, kCOLOR_BLUE);
        }

        posx += cellsize;
    }

    posy += cellsize;
}
}

/*-----*/

static void i_OnDraw(App *app, Event *e)
{
    const EvDraw *p = event_params(e, EvDraw);
    i_draw_clipped(app, p->ctx, p->x, p->y, p->width, p->height);
}

/*-----*/

static void i_OnOverlay(App *app, Event *e)
{
    const EvDraw *p = event_params(e, EvDraw);
    cassert_no_null(app);
    if (app->overlay == TRUE)
    {
        draw_fill_color(p->ctx, kCOLOR_BLACK);
        draw_text_color(p->ctx, kCOLOR_WHITE);
        draw_rect(p->ctx, ekFILL, 5, 5, 80, 20);
        draw_text(p->ctx, "OVERLAY", 5, 5);
    }
}
}

```

```

/*-----*/

static void i_mouse_cell(App *app, const real32_t x, const real32_t y, const
↳ uint32_t action)
{
    real32_t cellsize = i_CELL_SIZE + (real32_t)app->margin;
    uint32_t mx = (uint32_t)bmath_floorf(x / cellsize);
    uint32_t my = (uint32_t)bmath_floorf(y / cellsize);
    real32_t xmin = mx * cellsize + (real32_t)app->margin;
    real32_t xmax = xmin + i_CELL_SIZE;
    real32_t ymin = my * cellsize + (real32_t)app->margin;
    real32_t ymax = ymin + i_CELL_SIZE;

    if (x >= xmin && x <= xmax && y >= ymin && y <= ymax)
    {
        if (action == 0)
        {
            app->mouse_cell_x = mx;
            app->mouse_cell_y = my;
        }
        else
        {
            app->sel_cell_x = mx;
            app->sel_cell_y = my;
        }
    }
    else
    {
        app->mouse_cell_x = UINT32_MAX;
        app->mouse_cell_y = UINT32_MAX;
    }

    view_update(app->view);
}

/*-----*/

static void i_OnMove(App *app, Event *e)
{
    const EvMouse *p = event_params(e, EvMouse);
    i_mouse_cell(app, p->x, p->y, 0);
}

/*-----*/

static void i_OnUp(App *app, Event *e)
{
    const EvMouse *p = event_params(e, EvMouse);
    i_mouse_cell(app, p->x, p->y, 0);
}

```

```

/*-----*/

static void i_OnDown(App *app, Event *e)
{
    const EvMouse *p = event_params(e, EvMouse);
    i_mouse_cell(app, p->x, p->y, 1);
}

/*-----*/

static void i_OnFocus(App *app, Event *e)
{
    const bool_t *p = event_params(e, bool_t);
    app->focus = *p;
    view_update(app->view);
}

/*-----*/

static void i_OnKeyDown(App *app, Event *e)
{
    const EvKey *p = event_params(e, EvKey);
    View *view = event_sender(e, View);
    real32_t margin = (real32_t)app->margin;
    real32_t cellsize = i_CELL_SIZE + margin;
    V2Df scroll;
    S2Df size;

    view_viewport(view, &scroll, &size);

    if (p->key == ekKEY_DOWN && app->sel_cell_y < i_NUM_ROWS - 1)
    {
        real32_t ymin = (app->sel_cell_y + 1) * cellsize + margin;
        ymin += i_CELL_SIZE;

        if (scroll.y + size.height <= ymin)
        {
            view_scroll_y(view, ymin - size.height + margin);
            app->mouse_cell_x = UINT32_MAX;
            app->mouse_cell_y = UINT32_MAX;
        }

        app->sel_cell_y += 1;
        view_update(app->view);
    }

    if (p->key == ekKEY_UP && app->sel_cell_y > 0)
    {
        real32_t ymin = (app->sel_cell_y - 1) * cellsize + (real32_t)app->
        ↵ margin;
    }
}

```

```

if (scroll.y >= ymin)
{
    view_scroll_y(view, ymin - margin);
    app->mouse_cell_x = UINT32_MAX;
    app->mouse_cell_y = UINT32_MAX;
}

app->sel_cell_y -= 1;
view_update(app->view);
}

if (p->key == ekKEY_RIGHT && app->sel_cell_x < i_NUM_COLS - 1)
{
    real32_t xmin = (app->sel_cell_x + 1) * cellsize + margin;
    xmin += i_CELL_SIZE;

    if (scroll.x + size.width <= xmin)
    {
        view_scroll_x(view, xmin - size.width + margin);
        app->mouse_cell_x = UINT32_MAX;
        app->mouse_cell_y = UINT32_MAX;
    }

    app->sel_cell_x += 1;
    view_update(app->view);
}

if (p->key == ekKEY_LEFT && app->sel_cell_x > 0)
{
    real32_t xmin = (app->sel_cell_x - 1) * cellsize + (real32_t)app->
    ↪ margin;

    if (scroll.x >= xmin)
    {
        view_scroll_x(view, xmin - margin);
        app->mouse_cell_x = UINT32_MAX;
        app->mouse_cell_y = UINT32_MAX;
    }

    app->sel_cell_x -= 1;
    view_update(app->view);
}

if (p->key == ekKEY_RETURN)
{
    panel_visible_layout(app->panel, 1);
    panel_update(app->panel);
    window_focus(app->window, guicontrol(app->fullview));
}
}

```

```

/*-----*/

static void i_OnDataChange(App *app, Event *e)
{
    unref(e);

    /* If col/row editbox are changed, change the focused cell in view */
    if (evbind_modify(e, App, uint32_t, col_id) == TRUE
        || evbind_modify(e, App, uint32_t, row_id) == TRUE)
    {
        app->sel_cell_x = app->col_id;
        app->sel_cell_y = app->row_id;
    }

    i_scroll_to_cell(app);
    view_update(app->view);
}

/*-----*/

static void i_flyout_over_control(App *app, GuiControl *control, const uint32_t
    ↪ align)
{
    /* Control bounds in window coordinates */
    R2Df frame = window_control_frame(app->window, control);
    /* Top-Left control in screen coordinates */
    V2Df pos = window_client_to_screen(app->window, frame.pos);
    /* Flyout window size */
    S2Df size = window_get_size(app->flyout);

    switch (align) {
    case 0:
        break;
    case 1:
        pos.y += (frame.size.height - size.height);
        break;
    case 2:
        pos.x += (frame.size.width - size.width);
        break;
    case 3:
        pos.x += (frame.size.width - size.width);
        pos.y += (frame.size.height - size.height);
        break;
    }

    /* Position in screen coordinates */
    window_origin(app->flyout, pos);
    window_overlay(app->flyout, app->window);
}

/*-----*/

```

```

static uint32_t i_listbox_sel(ListBox *list)
{
    uint32_t i, n = listbox_count(list);
    for (i = 0; i < n; ++i)
    {
        if (listbox_selected(list, i) == TRUE)
            return i;
    }

    return 0;
}

/*-----*/

static void i_OnIdleLaunch(App *app, Event *e)
{
    GuiControl *control = guicontrol(app->list1);
    uint32_t selctrl = i_listbox_sel(app->list1);
    uint32_t selalign = i_listbox_sel(app->list2);
    switch (selctrl) {
    case 0:
        control = guicontrol(app->list1);
        break;
    case 1:
        control = guicontrol(app->list2);
        break;
    case 2:
        control = guicontrol(app->list3);
        break;
    case 3:
        control = guicontrol(app->table);
        break;
    case 4:
        control = guicontrol(app->view);
        break;
    case 5:
        control = guicontrol(app->edit1);
        break;
    case 6:
        control = guicontrol(app->edit2);
        break;
    }

    i_flyout_over_control(app, control, selalign);
    unref(e);
}

/*-----*/

static void i_OnFlyoutClick(App *app, Event *e)

```

```

{
    gui_OnIdle(listener(app, i_OnIdleLaunch, App));
    unref(e);
}

/*-----*/

static void i_OnColored(App *app, Event *e)
{
    const EvButton *p = event_params(e, EvButton);
    if (p->state == ekGUI_ON)
    {
        layout_bgcolor(app->main_layout, color_rgb(128, 0, 0));
        layout_bgcolor(app->middle_layout, color_rgb(0, 128, 0));
        layout_bgcolor(app->control_layout, color_rgb(0, 0, 128));
        layout_bgcolor(app->info_layout, color_rgb(128, 128, 0));
    }
    else
    {
        layout_bgcolor(app->main_layout, kCOLOR_DEFAULT);
        layout_bgcolor(app->middle_layout, kCOLOR_DEFAULT);
        layout_bgcolor(app->control_layout, kCOLOR_DEFAULT);
        layout_bgcolor(app->info_layout, kCOLOR_DEFAULT);
    }

    panel_update(app->panel);
}

/*-----*/

static Layout *i_control_layout(App *app)
{
    Layout *layout = layout_create(10, 1);
    Label *label1 = label_create();
    Label *label2 = label_create();
    Label *label3 = label_create();
    Edit *edit1 = edit_create();
    Edit *edit2 = edit_create();
    Slider *slider = slider_create();
    Button *button1 = button_check();
    Button *button2 = button_push();
    Button *button3 = button_check();
    label_text(label1, "Goto Col:");
    label_text(label2, "Row:");
    label_text(label3, "Margin:");
    edit_align(edit1, ekRIGHT);
    edit_align(edit2, ekRIGHT);
    button_text(button1, "Draw overlay");
    button_text(button2, "Flyout");
    button_text(button3, "Colored");
    button_tooltip(button1, "Draw a fixed overlay on top of scrolled view");
}

```

```

button_tooltip(button2, "Display a flyout window over the control selected
    ↔ in list-1, with alignment selected in list-2");
button_tooltip(button3, "Enable/disable the layout colouring");
button_OnClick(button2, listener(app, i_OnFlyoutClick, App));
button_OnClick(button3, listener(app, i_OnColored, App));
layout_label(layout, label1, 0, 0);
layout_label(layout, label2, 2, 0);
layout_label(layout, label3, 4, 0);
layout_edit(layout, edit1, 1, 0);
layout_edit(layout, edit2, 3, 0);
layout_slider(layout, slider, 5, 0);
layout_button(layout, button1, 6, 0);
layout_button(layout, button2, 7, 0);
layout_button(layout, button3, 9, 0);

/* Force the width of editbox columns */
layout_hsize(layout, 1, 50);
layout_hsize(layout, 3, 50);

/* Horizontal margins between controls */
layout_hmargin(layout, 0, 5);
layout_hmargin(layout, 1, 5);
layout_hmargin(layout, 2, 5);
layout_hmargin(layout, 3, 5);
layout_hmargin(layout, 4, 5);
layout_hmargin(layout, 5, 5);
layout_hmargin(layout, 6, 5);
layout_hmargin(layout, 7, 5);

/* All the horizontal expansion will be done in an empty cell between
 * 'Colored' checkbox and 'Flyout' button */
layout_hexpand(layout, 8);

/* Data binding */
cell_dbind(layout_cell(layout, 1, 0), App, uint32_t, col_id);
cell_dbind(layout_cell(layout, 3, 0), App, uint32_t, row_id);
cell_dbind(layout_cell(layout, 5, 0), App, uint32_t, margin);
cell_dbind(layout_cell(layout, 6, 0), App, bool_t, overlay);

app->edit1 = edit1;
app->edit2 = edit2;
app->control_layout = layout;
return layout;
}

/*-----*/

static Layout *i_info_layout(App *app)
{
    Layout *layout = layout_create(4, 1);
    Label *label1 = label_create();

```



```

Label *label2 = label_create();
Progress *progress = progress_create();
char_t text[256];

label_align(label2, ekRIGHT);

layout_label(layout, label1, 0, 0);
layout_label(layout, label2, 3, 0);
layout_progress(layout, progress, 1, 0);
layout_hmargin(layout, 0, 10);

/* All the horizontal expansion will be done in empty column-cell(2) */
layout_hexpand(layout, 2);

/* Keep the labels for futher updates */
app->status_label = label1;
app->cells_label = label2;

/* Text for labels dimensioning */
bstd_sprintf(text, sizeof(text), i_CELLS_INFO, 1000, 1000, 1000, 1000);
label_size_text(app->cells_label, text);
label_size_text(app->status_label, i_STATUS_TEXT);
label_text(app->status_label, i_STATUS_TEXT);
app->info_layout = layout;
app->progress = progress;
return layout;
}

/*-----*/

static Layout *i_list_layout(App *app)
{
    Layout *layout = layout_create(1, 6);
    Label *label1 = label_create();
    Label *label2 = label_create();
    Label *label3 = label_create();
    ListBox *list1 = listbox_create();
    ListBox *list2 = listbox_create();
    ListBox *list3 = listbox_create();
    label_text(label1, "Flyout control");
    label_text(label2, "Flyout align");
    label_text(label3, "List-3");
    listbox_add_elem(list1, "List 1", NULL);
    listbox_add_elem(list1, "List 2", NULL);
    listbox_add_elem(list1, "List 3", NULL);
    listbox_add_elem(list1, "Table", NULL);
    listbox_add_elem(list1, "View", NULL);
    listbox_add_elem(list1, "Edit 1", NULL);
    listbox_add_elem(list1, "Edit 2", NULL);
    listbox_add_elem(list2, "Left-Top", NULL);
    listbox_add_elem(list2, "Left-Bottom", NULL);
}

```

```

listbox_add_elem(list2, "Right-Top", NULL);
listbox_add_elem(list2, "Right-Bottom", NULL);
listbox_add_elem(list3, "Item 1", NULL);
listbox_add_elem(list3, "Item 2", NULL);
listbox_add_elem(list3, "Item 3", NULL);
listbox_add_elem(list3, "Item 4", NULL);
listbox_select(list1, 0, TRUE);
listbox_select(list2, 0, TRUE);
listbox_select(list3, 0, TRUE);

/* Natural size of listboxes */
listbox_size(list1, s2df(150, 100));
listbox_size(list2, s2df(150, 100));
listbox_size(list3, s2df(150, 100));

layout_label(layout, label1, 0, 0);
layout_label(layout, label2, 0, 2);
layout_label(layout, label3, 0, 4);
layout_listbox(layout, list1, 0, 1);
layout_listbox(layout, list2, 0, 3);
layout_listbox(layout, list3, 0, 5);

/* Vertical margin between a label and the above listbox */
layout_vmargin(layout, 1, 5);
layout_vmargin(layout, 3, 5);

/* The vertical expansion will be distributed equally between listboxes */
layout_vexpand3(layout, 1, 3, 5, .33f, .33f);

app->list1 = list1;
app->list2 = list2;
app->list3 = list3;
return layout;
}

/*-----*/

static void i_OnTable(App *app, Event *e)
{
    uint32_t etype = event_type(e);

    switch (etype) {
    case ekGUI_EVENT_TBL_NROWS:
    {
        uint32_t *n = event_result(e, uint32_t);
        *n = 20;
        break;
    }

    case ekGUI_EVENT_TBL_CELL:
    {

```

```

        const EvTbPos *pos = event_params(e, EvTbPos);
        EvTbCell *cell = event_result(e, EvTbCell);
        bstd_sprintf(app->temptxt, sizeof(app->temptxt), "Name %d", pos->row);
        cell->text = app->temptxt;
        break;
    }
}

/*-----*/

static Layout *i_table_layout(App *app)
{
    Layout *layout = layout_create(1, 1);
    TableView *table = tableview_create();
    tableview_new_column_text(table);
    tableview_size(table, s2df(150, 200));
    tableview_column_width(table, 0, 120);
    tableview_OnData(table, listener(app, i_OnTable, App));
    tableview_update(table);
    layout_tableview(layout, table, 0, 0);
    app->table = table;
    return layout;
}

/*-----*/

static Layout *i_middle_layout(App *app)
{
    Layout *layout1 = layout_create(3, 1);
    Layout *layout2 = i_list_layout(app);
    Layout *layout3 = i_table_layout(app);
    View *view = view_scroll();
    view_size(view, s2df(450, 200));
    view_OnDraw(view, listener(app, i_OnDraw, App));
    view_OnOverlay(view, listener(app, i_OnOverlay, App));
    view_OnMove(view, listener(app, i_OnMove, App));
    view_OnUp(view, listener(app, i_OnUp, App));
    view_OnDown(view, listener(app, i_OnDown, App));
    view_OnFocus(view, listener(app, i_OnFocus, App));
    view_OnKeyDown(view, listener(app, i_OnKeyDown, App));
    layout_layout(layout1, layout2, 0, 0);
    layout_view(layout1, view, 1, 0);
    layout_layout(layout1, layout3, 2, 0);

    /* Add the view to tabstop list */
    layout_tabstop(layout1, 1, 0, TRUE);

    /* A small horizontal margin between view cell and list (left) table (right
       ↪ ) layouts */
    layout_hmargin(layout1, 0, 3);
}

```

```

    layout_hmargin(layout1, 1, 3);

    /* All the horizontal expansion will be done in the middle cell (view)
       list_layout (left) and table_layout (right) will preserve the 'natural'
       ↪ width */
    layout_hexpand(layout1, 1);
    app->view = view;
    app->middle_layout = layout1;
    return layout1;
}

/*-----*/

static Layout *i_multi_layout(App *app)
{
    Layout *layout1 = layout_create(1, 3);
    Layout *layout2 = i_control_layout(app);
    Layout *layout3 = i_middle_layout(app);
    Layout *layout4 = i_info_layout(app);
    layout_layout(layout1, layout2, 0, 0);
    layout_layout(layout1, layout3, 0, 1);
    layout_layout(layout1, layout4, 0, 2);

    /* All the vertical expansion will be done in the middle layout
       control_layout (top) and info_layout (bottom) will preserve the 'natural'
       ↪ height */
    layout_vexpand(layout1, 1);

    /* A vertical margins between middle and (controls, info) */
    layout_vmargin(layout1, 0, 5);
    layout_vmargin(layout1, 1, 5);

    /* A border margin for all layout edges */
    layout_margin(layout1, 5);

    /* Object binding to main layout */
    layout_dbind(layout1, listener(app, i_OnDataChange, App), App);
    layout_dbind_obj(layout1, app, App);

    return layout1;
}

/*-----*/

static void i_OnDrawFull(App *app, Event *e)
{
    const EvDraw *p = event_params(e, EvDraw);
    char_t text[128];
    real32_t twidth = 0, theight = 0;
    real32_t radius = 100;

```

```

/* Background */
draw_fill_color(p->ctx, app->backcolor);
draw_rect(p->ctx, ekFILL, p->x, p->y, p->width, p->height);

/* Draw a text centered into view */
draw_text_color(p->ctx, gui_label_color());
draw_font(p->ctx, app->fullfont);
draw_text_align(p->ctx, ekCENTER, ekCENTER);
draw_text_halign(p->ctx, ekCENTER);
bstd_sprintf(text, sizeof(text), "Cell col: %d\nCell row: %d", app->
    ↪ sel_cell_x, app->sel_cell_y);
draw_text(p->ctx, text, p->width / 2, p->height / 2);

/* Draw a text border */
draw_line_color(p->ctx, app->drawcolor);
draw_line_width(p->ctx, 3);
draw_text_extents(p->ctx, text, -1, &twidth, &theight);
draw_rect(p->ctx, ekSTROKE, (p->width - twidth) / 2, (p->height - theight)
    ↪ / 2, twidth, theight);

/* Draw corner circles */
draw_line_color(p->ctx, kCOLOR_RED);
draw_fill_color(p->ctx, app->drawcolor);
draw_circle(p->ctx, ekSKFILL, 0, 0, radius);
draw_circle(p->ctx, ekSKFILL, 0, p->height, radius);
draw_circle(p->ctx, ekSKFILL, p->width, 0, radius);
draw_circle(p->ctx, ekSKFILL, p->width, p->height, radius);
unref(app);
}

/*-----*/

static void i_OnKeyDownFull(App *app, Event *e)
{
    /* If we press any key with the fullview active, the normal
     * layout will be restored and draw big view focused*/
    panel_visible_layout(app->panel, 0);
    panel_update(app->panel);
    window_focus(app->window, guicontrol(app->view));
    unref(e);
}

/*-----*/

static Layout *i_full_layout(App *app)
{
    Layout *layout = layout_create(1, 1);
    View *view = view_create();
    view_OnDraw(view, listener(app, i_OnDrawFull, App));
    view_OnKeyDown(view, listener(app, i_OnKeyDownFull, App));
    layout_view(layout, view, 0, 0);
}

```

```

    app->fullview = view;
    return layout;
}

/*-----*/

static Panel *i_panel(App *app)
{
    Panel *panel = panel_create();
    Layout *layout1 = i_multi_layout(app);
    Layout *layout2 = i_full_layout(app);
    panel_layout(panel, layout1);
    panel_layout(panel, layout2);
    app->main_layout = layout1;
    return panel;
}

/*-----*/

static void i_OnMoved(App *app, Event *e)
{
    const EvPos *p = event_params(e, EvPos);
    bstd_printf("Window moved: (%d, %d)\n", (uint32_t)p->x, (uint32_t)p->y);
    unref(app);
}

/*-----*/

static void i_OnClose(App *app, Event *e)
{
    osapp_finish();
    unref(app);
    unref(e);
}

/*-----*/

static Window *i_create_flywin(void)
{
    uint32_t nrows = 4;
    Layout *layout = layout_create(2, nrows);
    Panel *panel = panel_create();
    Window *window = window_create(ekWINDOW_RETURN | ekWINDOW_ESC);
    uint32_t i;

    for (i = 0; i < nrows; ++i)
    {
        char_t text[64];
        Label *label = label_create();
        Slider *slider = slider_create();
        bstd_sprintf(text, sizeof(text), "Flyout control %d", i);
    }
}

```

```

    label_text(label, text);
    layout_label(layout, label, 0, i);
    layout_slider(layout, slider, 1, i);

    if (i < nrows - 1)
        layout_vmargin(layout, i, 5);
}

layout_hmargin(layout, 0, 5);
layout_margin(layout, 10);
layout_skcolor(layout, kCOLOR_RED);
panel_layout(panel, layout);
window_panel(window, panel);
return window;
}

/*-----*/

static App *i_create(void)
{
    App *app = heap_new0(App);
    Panel *panel = NULL;
    i_dbind();
    app->col_id = 50;
    app->row_id = 50;
    app->margin = 10;
    app->mouse_cell_x = UINT32_MAX;
    app->mouse_cell_y = UINT32_MAX;
    app->sel_cell_x = app->col_id;
    app->sel_cell_y = app->row_id;
    app->overlay = FALSE;
    app->focus = FALSE;
    panel = i_panel(app);
    app->window = window_create(ekWINDOW_STDRES);
    app->flyout = i_create_flywin();
    app->panel = panel;
    app->anim_frame = 0;
    app->anim_total = str_len_c(i_STATUS_TEXT);
    app->fullfont = font_system(40, 0);
    app->drawcolor = gui_alt_color(color_rgb(80, 80, 240), color_rgb(240, 240,
        ↪ 80));
    app->backcolor = gui_alt_color(color_rgb(200, 240, 200), color_rgb(80, 128,
        ↪ 80));
    i_content_size(app);
    window_panel(app->window, panel);
    window_title(app->window, "Big drawing area");
    window_origin(app->window, v2df(500, 200));
    window_OnMoved(app->window, listener(app, i_OnMoved, App));
    window_OnClose(app->window, listener(app, i_OnClose, App));
    window_show(app->window);
    /* The keyboard focus initially into the view */
}

```

```

    window_focus(app->window, guicontrol(app->view));
    i_scroll_to_cell(app);
    return app;
}

/*-----*/

static void i_destroy(App **app)
{
    window_destroy(&(*app)->window);
    window_destroy(&(*app)->flyout);
    font_destroy(&(*app)->fullfont);
    heap_delete(app, App);
}

/*-----*/

static void i_update(App *app, const real64_t prtime, const real64_t ctime)
{
    char_t text[128];
    unref(prtime);
    unref(ctime);
    str_copy_cn(text, sizeof(text), i_STATUS_TEXT, app->anim_frame);
    label_text(app->status_label, text);
    progress_value(app->progress, (real32_t)app->anim_frame / (real32_t)app->
        ↪ anim_total);
    app->anim_frame += 1;
    if (app->anim_frame > app->anim_total)
        app->anim_frame = 0;
}

/*-----*/

#include "osmain.h"
osmain_sync(0.1, i_create, i_destroy, i_update, "", App)

```

Images from URLs

34.1 Images from URLs

761

34.1. Images from URLs

In this demo we build a simple web image viewer. The program allows you to download and view them through a list. The **source code** is in folder `/demo/urlimg` of the SDK distribution.

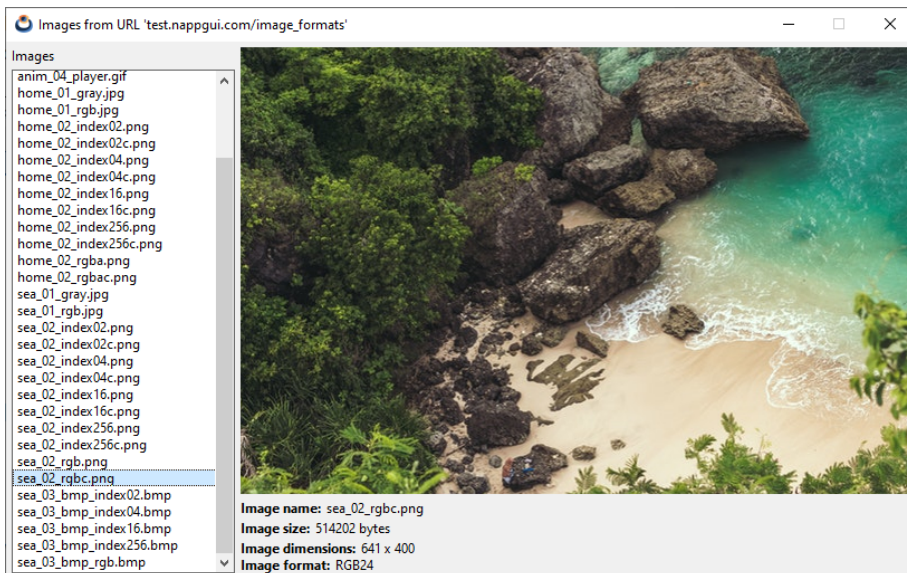

Figure 34.1: Windows version

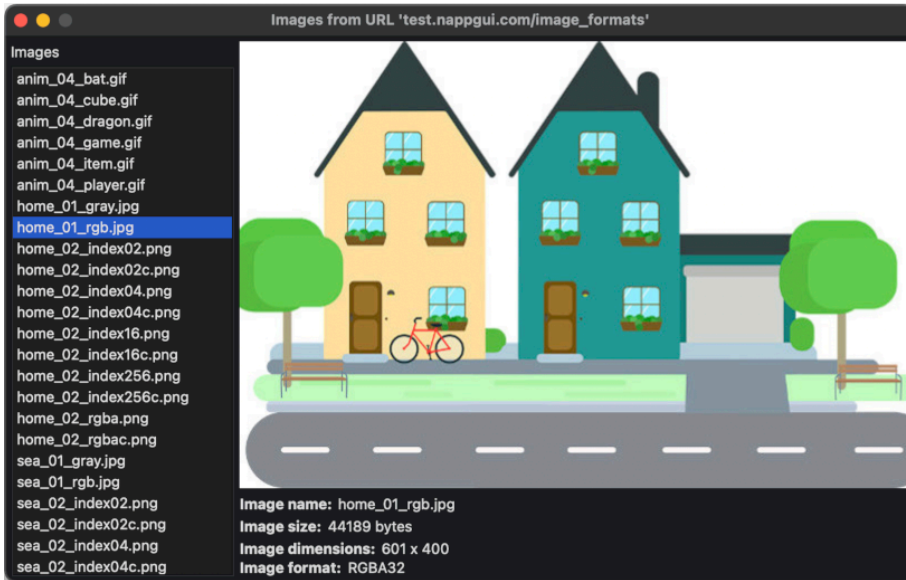

Figure 34.2: macOS version

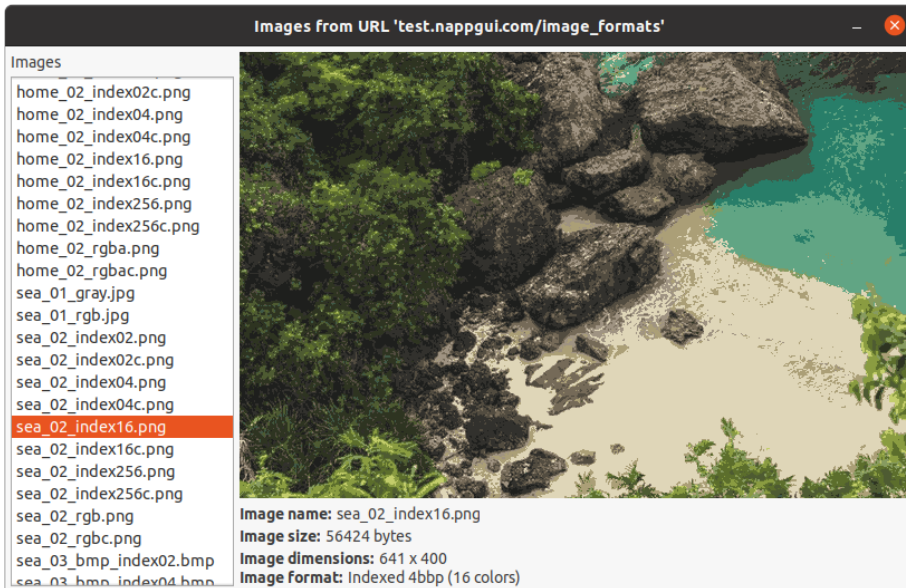

Figure 34.3: Linux version

Listing 34.1: demo/urlimg/urlimg.c

```
/* Images from URL */
#include <inet/inet.h>
```

```

#include <inet/httpreq.h>
#include <nappgui.h>

typedef struct _app_t App;

struct _app_t
{
    Window *window;
    ImageView *view;
    uint32_t selected;
    Label *imgname;
    Label *imgsize;
    Label *imgres;
    Label *imgformat;
};

static const char_t *i_FILES[] = {
    "anim_04_bat.gif",
    "anim_04_cube.gif",
    "anim_04_dragon.gif",
    "anim_04_game.gif",
    "anim_04_item.gif",
    "anim_04_player.gif",
    "static_05_cube.gif",
    "home_01_gray.jpg",
    "home_01_rgb.jpg",
    "home_02_index02.png",
    "home_02_index02c.png",
    "home_02_index04.png",
    "home_02_index04c.png",
    "home_02_index16.png",
    "home_02_index16c.png",
    "home_02_index256.png",
    "home_02_index256c.png",
    "home_02_rgba.png",
    "home_02_rgbac.png",
    "sea_01_gray.jpg",
    "sea_01_rgb.jpg",
    "sea_02_index02.png",
    "sea_02_index02c.png",
    "sea_02_index04.png",
    "sea_02_index04c.png",
    "sea_02_index16.png",
    "sea_02_index16c.png",
    "sea_02_index256.png",
    "sea_02_index256c.png",
    "sea_02_rgb.png",
    "sea_02_rgbc.png",
    "sea_03_bmp_index02.bmp",
    "sea_03_bmp_index04.bmp",
    "sea_03_bmp_index16.bmp",

```

```

"sea_03_bmp_index256.bmp",
"sea_03_bmp_rgb.bmp"};

/*-----*/

static __INLINE String *i_pixformat(const pixformat_t format, const uint32_t
↳ ncolors)
{
    switch (format)
    {
        case ekINDEX1:
            return str_printf("Indexed 1bbp (%d colors)", ncolors);
        case ekINDEX2:
            return str_printf("Indexed 2bbp (%d colors)", ncolors);
        case ekINDEX4:
            return str_printf("Indexed 4bbp (%d colors)", ncolors);
        case ekINDEX8:
            return str_printf("Indexed 8bbp (%d colors)", ncolors);
        case ekGRAY8:
            return str_c("Gray8");
        case ekRGB24:
            return str_c("RGB24");
        case ekRGBA32:
            return str_c("RGBA32");
        case ekFIMAGE:
            break;
    }
    return str_c("Unknown");
}

/*-----*/

static void i_download(App *app)
{
    String *url = str_printf("http://test.nappgui.com/image_formats/%s",
↳ i_FILES[app->selected]);
    Stream *stm = http_dget(tc(url), NULL, NULL);
    if (stm != NULL)
    {
        uint32_t ncolors = 0;
        uint64_t start = stm_bytes_readed(stm);
        Image *image = image_read(stm);
        uint64_t end = stm_bytes_readed(stm);
        uint32_t width = image_width(image);
        uint32_t height = image_width(image);
        pixformat_t format = image_format(image);
        String *ssize = str_printf("%d bytes", (uint32_t)(end - start));
        String *sres = NULL;
        String *sformat = NULL;

        /* Full check of read/write pixels

```

```

We create again the same image, based on pixel info */
if (image_get_codec(image) != ekGIF)
{
    Pixbuf *pixels = image_pixels(image, ekFIMAGE);
    Image *nimage = image_from_pixbuf(pixels, NULL);
    cassert(format == pixbuf_format(pixels));
    pixbuf_destroy(&pixels);
    image_destroy(&image);
    image = nimage;
}

imageview_image(app->view, image);
sres = str_printf("%d x %d", width, height);
sformat = i_pixformat(format, ncolors);
label_text(app->imgname, i_FILES[app->selected]);
label_text(app->imgsize, tc(ssize));
label_text(app->imgres, tc(sres));
label_text(app->imgformat, tc(sformat));
stm_close(&stm);
image_destroy(&image);
str_destroy(&ssize);
str_destroy(&sres);
str_destroy(&sformat);
}

str_destroy(&url);
}

/*-----*/

static Layout *i_label(const char_t *title, Label **info)
{
    Layout *layout = layout_create(2, 1);
    Label *label = label_create();
    Font *font = font_system(font_regular_size(), ekFBOLD);
    *info = label_create();
    label_text(label, title);
    label_font(label, font);
    layout_label(layout, label, 0, 0);
    layout_label(layout, *info, 1, 0);
    layout_halign(layout, 1, 0, ekJUSTIFY);
    layout_hmargin(layout, 0, 5);
    layout_hexpand(layout, 1);
    font_destroy(&font);
    return layout;
}

/*-----*/

static void i_add_files(ListBox *listbox)
{

```

```

uint32_t i, n = sizeof(i_FILES) / sizeof(char_t *);
for (i = 0; i < n; ++i)
    listbox_add_elem(listbox, i_FILES[i], NULL);
listbox_select(listbox, 0, TRUE);
}

/*-----*/

static void i_OnSelect(App *app, Event *e)
{
    const EvButton *p = event_params(e, EvButton);
    app->selected = p->index;
    i_download(app);
}

/*-----*/

static Panel *i_panel(App *app)
{
    Panel *panel = panel_create();
    Layout *layout1 = layout_create(2, 1);
    Layout *layout2 = layout_create(1, 2);
    Layout *layout3 = layout_create(1, 5);
    Label *label = label_create();
    ListBox *listbox = listbox_create();
    ImageView *view = imageview_create();
    app->view = view;
    label_text(label, "Images");
    i_add_files(listbox);
    listbox_OnSelect(listbox, listener(app, i_OnSelect, App));
    imageview_size(view, s2df(600, 400));
    layout_label(layout2, label, 0, 0);
    layout_listbox(layout2, listbox, 0, 1);
    layout_imageview(layout3, view, 0, 0);
    layout_layout(layout3, i_label("Image name:", &app->imgname), 0, 1);
    layout_layout(layout3, i_label("Image size:", &app->imgsize), 0, 2);
    layout_layout(layout3, i_label("Image dimensions:", &app->imgres), 0, 3);
    layout_layout(layout3, i_label("Pixel format:", &app->imgformat), 0, 4);
    layout_layout(layout1, layout2, 0, 0);
    layout_layout(layout1, layout3, 1, 0);
    layout_margin(layout1, 5);
    layout_hmargin(layout1, 0, 5);
    layout_vmargn(layout2, 0, 5);
    layout_vmargn(layout3, 0, 5);
    layout_vmargn(layout3, 1, 3);
    layout_vmargn(layout3, 2, 3);
    layout_hsize(layout1, 0, 200);
    layout_vexpand(layout2, 1);
    panel_layout(panel, layout1);
    return panel;
}

```

```

/*-----*/

static void i_OnClose(App *app, Event *e)
{
    osapp_finish();
    unref(app);
    unref(e);
}

/*-----*/

static App *i_create(void)
{
    App *app = heap_new0(App);
    Panel *panel = i_panel(app);
    app->window = window_create(ekWINDOW_STD);
    app->selected = 0;
    inet_start();
    i_download(app);
    window_panel(app->window, panel);
    window_title(app->window, "Images from URL 'http://test.nappgui.com/
    ↵ image_formats'");
    window_origin(app->window, v2df(500, 200));
    window_OnClose(app->window, listener(app, i_OnClose, App));
    window_show(app->window);
    return app;
}

/*-----*/

static void i_destroy(App **app)
{
    window_destroy(&(*app)->window);
    inet_finish();
    heap_delete(app, App);
}

/*-----*/

#include "osmain.h"
osmain(i_create, i_destroy, "", App)

```

Color table

35.1 Color table

769

35.1. Color table

The choice of arbitrary RGB colors for use in graphic interfaces will not always be consistent with the desktop theme of the target platform. In “*Colors*” (page 285) a series of “system” colors are defined and the possibility of creating alternative versions for light or dark themes. This demo shows this repertoire depending on the platform where the program runs. The **source code** is in folder `/demo/colorview` of the SDK distribution.

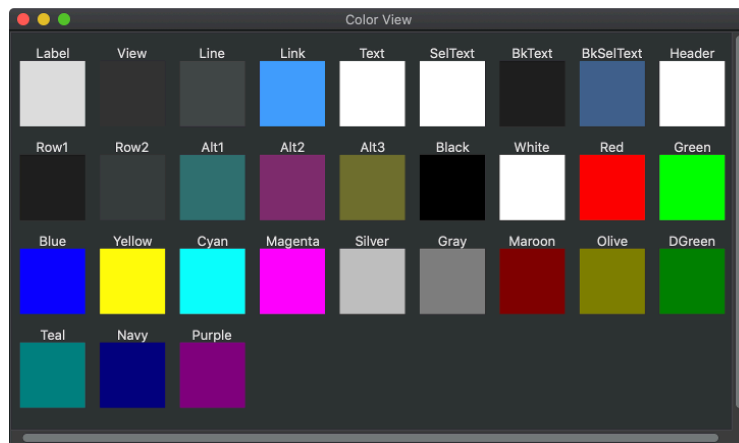

Figure 35.1: Color table.

Listing 35.1: `demo/colorview/colorview.c`

```

/* Color View */

#include <nappgui.h>

typedef struct _viewitem_t ViewItem;
typedef struct _app_t App;

struct _viewitem_t
{
    const char_t *name;
    color_t color;
};

struct _app_t
{
    Window *window;
    View *view;
    ArrSt(ViewItem) *items;
    uint32_t num_cols;
    Font *font;
};

DeclSt(ViewItem);
static const real32_t i_ITEM_WIDTH = 64;
static const real32_t i_VER_MARGIN = 10;
static const real32_t i_HOR_MARGIN = 15;

/*-----*/

static void i_add(ArrSt(ViewItem) *items, const char_t *name, const color_t
    ↪ color)
{
    ViewItem *item = arrst_new(items, ViewItem);
    item->name = name;
    item->color = color;
}

/*-----*/

static ArrSt(ViewItem) *i_colors(void)
{
    ArrSt(ViewItem) *items = arrst_create(ViewItem);
    i_add(items, "Label", gui_label_color());
    i_add(items, "View", gui_view_color());
    i_add(items, "Line", gui_line_color());
    i_add(items, "Border", gui_border_color());
    i_add(items, "Link", gui_link_color());
    i_add(items, "Alt1", gui_alt_color(color_rgb(192, 255, 255), color_rgb(48,
    ↪ 112, 112)));
    i_add(items, "Alt2", gui_alt_color(color_rgb(255, 192, 255), color_rgb(128,
    ↪ 48, 112)));
}

```

```

i_add(items, "Alt3", gui_alt_color(color_rgb(255, 255, 192), color_rgb(112,
↪ 112, 48)));
i_add(items, "Black", kCOLOR_BLACK);
i_add(items, "White", kCOLOR_WHITE);
i_add(items, "Red", kCOLOR_RED);
i_add(items, "Green", kCOLOR_GREEN);
i_add(items, "Blue", kCOLOR_BLUE);
i_add(items, "Yellow", kCOLOR_YELLOW);
i_add(items, "Cyan", kCOLOR_CYAN);
i_add(items, "Magenta", kCOLOR_MAGENTA);
i_add(items, "Silver", color_rgb(192, 192, 192));
i_add(items, "Gray", color_rgb(128, 128, 128));
i_add(items, "Maroon", color_rgb(128, 0, 0));
i_add(items, "Olive", color_rgb(128, 128, 0));
i_add(items, "DGreen", color_rgb(0, 128, 0));
i_add(items, "Teal", color_rgb(0, 128, 128));
i_add(items, "Navy", color_rgb(0, 0, 128));
i_add(items, "Purple", color_rgb(128, 0, 128));
return items;
}

/*-----*/

static void i_draw(DCtx *ctx, real32_t x, real32_t y, real32_t width, real32_t
↪ height, const ViewItem *item)
{
    real32_t cx1 = x + width / 2;
    real32_t cx2 = x + (width - i_ITEM_WIDTH) / 2;
    real32_t cy = y + height - i_ITEM_WIDTH;
    draw_fill_color(ctx, item->color);
    draw_rect(ctx, ekFILL, cx2, cy, i_ITEM_WIDTH, i_ITEM_WIDTH);
    draw_text_color(ctx, gui_label_color());
    draw_text(ctx, item->name, cx1, cy);
}

/*-----*/

static void i_OnDraw(App *app, Event *e)
{
    const EvDraw *p = event_params(e, EvDraw);
    real32_t cwidth = (p->width - 2 * i_HOR_MARGIN) / app->num_cols;
    real32_t cheight = i_ITEM_WIDTH + font_height(app->font);

    draw_font(p->ctx, app->font);
    draw_text_align(p->ctx, ekCENTER, ekBOTTOM);

    arrst_foreach(item, app->items, ViewItem)
        uint32_t row = item_i / app->num_cols;
        uint32_t col = item_i % app->num_cols;
        real32_t x = i_HOR_MARGIN + col * cwidth;
        real32_t y = row * cheight + (row + 1) * i_VER_MARGIN;

```

```

        i_draw(p->ctx, x, y, cwidth, cheight, item);
    arrst_end()
}

/*-----*/

static void i_OnSize(App *app, Event *e)
{
    const EvSize *p = event_params(e, EvSize);
    View *view = event_sender(e, View);
    real32_t minwidth = i_ITEM_WIDTH + 2 * i_HOR_MARGIN;
    real32_t cwidth = 0, cheight = 0;

    cwidth = p->width;

    if (cwidth < minwidth)
    {
        cwidth = minwidth;
        app->num_cols = 1;
    }
    else
    {
        uint32_t n, num_rows;
        app->num_cols = (uint32_t)((cwidth - i_HOR_MARGIN) / (i_ITEM_WIDTH +
            ↪ i_HOR_MARGIN));
        n = arrst_size(app->items, ViewItem);
        num_rows = (n / app->num_cols);
        if ((n % app->num_cols) > 0)
            num_rows += 1;

        cheight = num_rows * (i_ITEM_WIDTH + font_height(app->font) +
            ↪ i_VER_MARGIN) + i_VER_MARGIN;
        if (cheight < p->height)
            cheight = p->height;
    }

    view_content_size(view, s2df(cwidth, cheight), s2df(1, 1));
    view_update(view);
}

/*-----*/

static Panel *i_panel(App *app)
{
    Panel *panel = panel_create();
    Layout *layout = layout_create(1, 1);
    View *view = view_scroll();
    view_size(view, s2df(300, 200));
    view_OnDraw(view, listener(app, i_OnDraw, App));
    view_OnSize(view, listener(app, i_OnSize, App));
    layout_view(layout, view, 0, 0);
}

```

```

    panel_layout(panel, layout);
    return panel;
}

/*-----*/

static void i_OnClose(App *app, Event *e)
{
    osapp_finish();
    unref(app);
    unref(e);
}

/*-----*/

static App *i_create(void)
{
    App *app = heap_new0(App);
    Panel *panel = i_panel(app);
    app->items = i_colors();
    app->font = font_system(font_regular_size(), 0);
    app->window = window_create(ekWINDOW_STDRES);
    window_panel(app->window, panel);
    window_title(app->window, "Color View");
    window_origin(app->window, v2df(500, 200));
    window_size(app->window, s2df(500, 300));
    window_OnClose(app->window, listener(app, i_OnClose, App));
    window_show(app->window);
    return app;
}

/*-----*/

static void i_destroy(App **app)
{
    arrst_destroy(&(*app)->items, NULL, ViewItem);
    window_destroy(&(*app)->window);
    font_destroy(&(*app)->font);
    heap_delete(app, App);
}

/*-----*/

#include "osmain.h"
osmain(i_create, i_destroy, "", App)

```

Read/Write Json

36.1 Read/Write Json

775

36.1. Read/Write Json

Listing 36.1: demo/htjson/htjson.c

```
/* JSON parsing examples */

#include "res_htjson.h"
#include <draw2d/draw2dall.h>
#include <inet/json.h>

/*-----*/

/* C structs that map a Json object */
typedef struct _product_t Product;
typedef struct _products_t Products;

struct _product_t
{
    String *description;
    real32_t price;
};

struct _products_t
{
    uint32_t size;
    ArrSt(Product) *data;
};

DeclSt(Product);
```



```

/*-----*/

static Stream *i_stm_from_json(const char_t *json_data)
{
    return stm_from_block((const byte_t *)json_data, str_len_c(json_data));
}

/*-----*/

int main(int argc, char *argv[])
{
    unref(argc);
    unref(argv);
    draw2d_start();

    /* Parsing a Json boolean */
    {
        Stream *stm = i_stm_from_json("true");
        bool_t *json = json_read(stm, NULL, bool_t);
        bstd_printf("bool_t from Json: %d\n", *json);
        json_destroy(&json, bool_t);
        stm_close(&stm);
    }

    /* Parsing a Json unsigned int */
    {
        Stream *stm = i_stm_from_json("6654");
        uint16_t *json = json_read(stm, NULL, uint16_t);
        bstd_printf("uint16_t from Json: %d\n", *json);
        json_destroy(&json, uint16_t);
        stm_close(&stm);
    }

    /* Parsing a Json signed int */
    {
        Stream *stm = i_stm_from_json("-567");
        int16_t *json = json_read(stm, NULL, int16_t);
        bstd_printf("int16_t from Json: %d\n", *json);
        json_destroy(&json, int16_t);
        stm_close(&stm);
    }

    /* Parsing a Json real */
    {
        Stream *stm = i_stm_from_json("456.45");
        real32_t *json = json_read(stm, NULL, real32_t);
        bstd_printf("real32_t from Json: %.3f\n", *json);
        json_destroy(&json, real32_t);
        stm_close(&stm);
    }
}

```

```

/* Parsing a Json string */
{
    Stream *stm = i_stm_from_json("\"Hello World\"");
    String *json = json_read(stm, NULL, String);
    bstd_printf("String from Json: %s\n", tc(json));
    json_destroy(&json, String);
    stm_close(&stm);
}

/* Parsing a Json b64 encoded image */
{
    uint32_t size;
    ResPack *pack = res_htjson_repack("");
    const byte_t *data = respack_file(pack, JSON_B64_IMAGE_TXT, &size);
    Stream *stm = stm_from_block(data, size);
    Image *json = json_read(stm, NULL, Image);
    uint32_t width = image_width(json);
    uint32_t height = image_height(json);
    bstd_printf("Image from Json: width: %d height: %d\n", width, height);
    json_destroy(&json, Image);
    stm_close(&stm);
    respack_destroy(&pack);
}

/* Parsing a Json int array */
{
    Stream *stm = i_stm_from_json("[ -321, 12, -8943, 228, -220, 347 ]");
    ArrSt(int16_t) *json = json_read(stm, NULL, ArrSt(int16_t));
    bstd_printf("ArrSt(int16_t) from Json: ");
    arrst_foreach(id, json, int16_t)
        bstd_printf("%d ", *id);
    arrst_end()
    bstd_printf("\n");
    json_destroy(&json, ArrSt(int16_t));
    stm_close(&stm);
}

/* Parsing a Json String array */
{
    Stream *stm = i_stm_from_json("[ \"Red\", \"Green\", \"Blue\", \"Yellow
↔ \", \"Orange\" ]");
    ArrPt(String) *json = json_read(stm, NULL, ArrPt(String));
    bstd_printf("ArrPt(String) from Json: ");
    arrpt_foreach(str, json, String)
        bstd_printf("%s ", tc(str));
    arrpt_end()
    bstd_printf("\n");
    json_destroy(&json, ArrPt(String));
    stm_close(&stm);
}

```

```

/* Data binding (only once time in application) */
/* This allows the Json parser to know the structure of the objects */
dbind(Product, String *, description);
dbind(Product, real32_t, price);
dbind(Products, uint32_t, size);
dbind(Products, ArrSt(Product) *, data);

/* Parsing a Json object */
{
    static const char_t *JSON_OBJECT = "\
    {\
        \"size\" : 3,\
        \"data\" : [\
            {\
                \"description\" : \"Intel i7-7700K\",\  
                \"price\" : 329.99\  
            },\  
            {\
                \"description\" : \"Ryzen-5-1600\",\  
                \"price\" : 194.99\  
            },\  
            {\
                \"description\" : \"GTX-1060\",\  
                \"price\" : 449.99\  
            }\  
        ]\  
    }";

    Stream *stm = i_stm_from_json(JSON_OBJECT);
    Products *json = json_read(stm, NULL, Products);
    bstd_printf("Products object from Json: size %d\n", json->size);
    arrst_foreach(elem, json->data, Product)
        bstd_printf("    Product: %s Price %.2f\n", tc(elem->description),
            ↪ elem->price);
    arrst_end()
    bstd_printf("\n");
    json_destroy(&json, Products);
    stm_close(&stm);
}

/* Writting data/objects to JSon */
{
    Stream *stm = stm_memory(1024);

    /* Write boolean as Json */
    {
        bool_t data_bool = TRUE;
        stm_writef(stm, "Json from bool_t: ");
        json_write(stm, &data_bool, NULL, bool_t);
        stm_writef(stm, "\n");
    }
}

```

```

}

/* Write unsigned integer as Json */
{
    uint16_t data_uint = 6654;
    stm_writef(stm, "Json from uint16_t: ");
    json_write(stm, &data_uint, NULL, uint16_t);
    stm_writef(stm, "\n");
}

/* Write integer as Json */
{
    int16_t data_int = -567;
    stm_writef(stm, "Json from int16_t: ");
    json_write(stm, &data_int, NULL, int16_t);
    stm_writef(stm, "\n");
}

/* Write real32_t as Json */
{
    real32_t data_real = 456.45f;
    stm_writef(stm, "Json from real32_t: ");
    json_write(stm, &data_real, NULL, real32_t);
    stm_writef(stm, "\n");
}

/* Write String as Json */
{
    String *data_str = str_c("Hello World");
    stm_writef(stm, "Json from String: ");
    json_write(stm, data_str, NULL, String);
    stm_writef(stm, "\n");
    str_destroy(&data_str);
}

/* Write Image as Json (string b64) */
{
    Pixbuf *pixbuf = pixbuf_create(2, 2, ekGRAY8);
    Image *data_image = NULL;
    bmem_set1(pixbuf_data(pixbuf), 2 * 2, 128);
    data_image = image_from_pixbuf(pixbuf, NULL);
    stm_writef(stm, "Json from Image: ");
    json_write(stm, data_image, NULL, Image);
    stm_writef(stm, "\n");
    pixbuf_destroy(&pixbuf);
    image_destroy(&data_image);
}

/* Write int array as Json */
{
    ArrSt(int16_t) *array = arrst_create(int16_t);

```

```

arrst_append(array, -321, int16_t);
arrst_append(array, 12, int16_t);
arrst_append(array, -8943, int16_t);
arrst_append(array, 228, int16_t);
arrst_append(array, -220, int16_t);
arrst_append(array, 347, int16_t);
stm_writelf(stm, "Json from int array: ");
json_write(stm, array, NULL, ArrSt(int16_t));
stm_writelf(stm, "\n");
arrst_destroy(&array, NULL, int16_t);
}

/* Write string array as Json */
{
    ArrPt(String) *array = arrpt_create(String);
    arrpt_append(array, str_c("Red"), String);
    arrpt_append(array, str_c("Green"), String);
    arrpt_append(array, str_c("Blue"), String);
    arrpt_append(array, str_c("Yellow"), String);
    arrpt_append(array, str_c("Orange"), String);
    stm_writelf(stm, "Json from string array: ");
    json_write(stm, array, NULL, ArrPt(String));
    stm_writelf(stm, "\n");
    arrpt_destroy(&array, str_destroy, String);
}

/* Write object as Json */
{
    Products *products = heap_new(Products);
    products->size = 3;
    products->data = arrst_create(Product);

    {
        Product *product = arrst_new(products->data, Product);
        product->description = str_c("Intel i7-7700K");
        product->price = 329.99f;
    }

    {
        Product *product = arrst_new(products->data, Product);
        product->description = str_c("Ryzen-5-1600");
        product->price = 194.99f;
    }

    {
        Product *product = arrst_new(products->data, Product);
        product->description = str_c("GTX-1060");
        product->price = 449.99f;
    }

    stm_writelf(stm, "Json from object: ");
}

```

```

    json_write(stm, products, NULL, Products);
    stm_writelf(stm, "\n");
    dbind_destroy(&products, Products);
}

{
    String *str = stm_str(stm);
    bstd_printf("%s\n", tc(str));
    str_destroy(&str);
}

stm_close(&stm);
}

draw2d_finish();
return 0;
}

```

Program output.

```

bool_t from Json: 1
uint16_t from Json: 6654
int16_t from Json: -567
real32_t from Json: 456.450
String from Json: Hello World
Image from Json: width: 269 height: 400
ArrSt(int16_t) from Json: -321 12 -8943 228 -220 347
ArrPt(String) from Json: Red Green Blue Yellow Orange
Products object from Json: size 3
    Product: Intel i7-7700K Price 329.99
    Product: Ryzen-5-1600 Price 194.99
    Product: GTX-1060 Price 449.99

Json from bool_t: true
Json from uint16_t: 6654
Json from int16_t: -567
Json from real32_t: 456.450012
Json from String: "Hello World"
Json from Image: "iVBORw0KGgoAAAANSUheEUgAAAAI..."
Json from int array: [ -321, 12, -8943, 228, -220, 347 ]
Json from string array: [ "Red", "Green", "Blue", "Yellow", "Orange" ]
Json from object: {"size" : 3, "data" : [ {"description" : "Intel i7-7700K", "
    ↳ price" : 329.989990 }, {"description" : "Ryzen-5-1600", "price" :
    ↳ 194.990005 }, {"description" : "GTX-1060", "price" : 449.989990 } ] }

```

Alternative to STL

37.1 Alternative to STL

783

37.1. Alternative to STL

The C++ *Standard Template Library* provides generic containers and algorithms as part of the language. The problem is that they cannot be used from “pure” C code, so NAppGUI provides an implementation of Arrays and Set at least as efficient as those of STL.

Result in i7-4970k Win10 x64

```
NAppGUI Containers vs STL.  
- Created 2000000 elements of 328 bytes  
- Starting...  
- Add to ArrSt(Product) and sort: 2.160294  
- Add to vector<Product> and sort: 2.499203  
- Add to ArrPt(Product) and sort: 0.697777  
- Add to vector<Product*> and sort: 0.541828  
- Add to SetSt(Product): 2.386245  
- Add to set<Product>: 2.533197  
- Add to SetPt(Product): 2.861091  
- Add to set<Product*>: 2.919082
```

Listing 37.1: demo/stlcmp/stlcmp.cpp

```
/* NAppGUI containers VS STL */  
  
#include <core/coreall.h>  
#include <core/arrst.hpp>  
#include <core/arrpt.hpp>  
#include <core/setst.hpp>
```



```

#include <core/setpt.hpp>
#include <sewer/nowarn.hxx>
#include <vector>
#include <set>
#include <algorithm>
#include <stdlib.h>
#include <sewer/warn.hxx>

using namespace std;

struct Product
{
    uint32_t id;
    char_t code[64];
    char_t description[256];
    real32_t price;
};

DeclSt(Product);
DeclPt(Product);

/*-----*/

static void i_init(Product *product, uint32_t id, real32_t price)
{
    cassert_no_null(product);
    product->id = id;
    bstd_sprintf(product->code, 64, "Code-[%d]", id);
    bstd_sprintf(product->description, 256, "Description-[%d]", id);
    product->price = price;
}

/*-----*/

static Product *i_create(uint32_t id, real32_t price)
{
    Product *product = heap_new(Product);
    i_init(product, id, price);
    return product;
}

/*-----*/

static int i_compare(const Product *p1, const Product *p2)
{
    return (int)p1->id - (int)p2->id;
}

/*-----*/

struct i_stl_compare

```

```

{
    inline bool operator()(const Product &lhs, const Product &rhs) const
    {
        return lhs.id < rhs.id;
    }

    inline bool operator()(const Product *lhs, const Product *rhs) const
    {
        return lhs->id < rhs->id;
    }
};

/*-----*/

// All stl destructors should be called before 'core_finish',
// because this function makes a Debug memory dump.
static void i_core_finish(void)
{
    core_finish();
}

/*-----*/

int main(int argc, char *argv[])
{
    bool_t err;
    uint32_t n;
    uint32_t *ids;
    Product *products;
    Product **pproducts;
    ArrSt(Product) *arrst;
    ArrPt(Product) *arrpt;
    SetSt(Product) *setst;
    SetPt(Product) *setpt;
    vector<Product> stl_arrst;
    vector<Product *> stl_arrpt;
    set<Product, i_stl_compare> stl_setst;
    set<Product *, i_stl_compare> stl_setpt;
    Clock *clock;
    real64_t t;

    core_start();
    atexit(i_core_finish);

    if (argc == 2)
    {
        n = str_to_u32(argv[1], 10, &err);
        if (err == TRUE)
        {
            log_printf("Use: stlcmp [size].");
            return 0;
        }
    }
}

```

```

    }
}
else
{
    n = 2000000;
}

bstd_printf("NAppGUI Containers vs STL.\n");

// Create the elements. This time is out of the test
// The elements will be shuffled randomly
ids = heap_new_n(n, uint32_t);
for (uint32_t i = 0; i < n; ++i)
    ids[i] = i;
bmath_rand_seed(526);
bmem_shuffle_n(ids, n, uint32_t);

products = heap_new_n(n, Product);
pproducts = heap_new_n(n, Product *);
for (uint32_t i = 0; i < n; ++i)
{
    i_init(&products[i], ids[i], 100.f + i);
    pproducts[i] = i_create(ids[i], 100.f + i);
}

arrst = arrst_create(Product);
arrpt = arrpt_create(Product);
setst = setst_create(i_compare, Product);
setpt = setpt_create(i_compare, Product);

clock = clock_create(0.);
bstd_printf("- Created %u elements of %u bytes\n", n, sizeof32(Product));
bstd_printf("- Starting...\n");

// NAppGUI struct array
clock_reset(clock);
for (uint32_t i = 0; i < n; ++i)
{
    Product *p = arrst_new(arrst, Product);
    *p = products[i];
}
arrst_sort(arrst, i_compare, Product);
t = clock_elapsed(clock);
bstd_printf("- Add to ArrSt(Product) and sort: %.6f\n", t);

// STL struct array
clock_reset(clock);
for (uint32_t i = 0; i < n; ++i)
    stl_arrst.push_back(products[i]);
sort(stl_arrst.begin(), stl_arrst.end(), i_stl_compare());
t = clock_elapsed(clock);

```

```

bstd_printf("- Add to vector<Product> and sort: %.6f\n", t);

// NAppGUI pointer array
clock_reset(clock);
for (uint32_t i = 0; i < n; ++i)
    arrpt_append(arrpt, pproducts[i], Product);
arrpt_sort(arrpt, i_compare, Product);
t = clock_elapsed(clock);
bstd_printf("- Add to ArrPt(Product) and sort: %.6f\n", t);

// STL pointer array
clock_reset(clock);
for (uint32_t i = 0; i < n; ++i)
    stl_arrpt.push_back(pproducts[i]);
sort(stl_arrpt.begin(), stl_arrpt.end(), i_stl_compare());
t = clock_elapsed(clock);
bstd_printf("- Add to vector<Product*> and sort: %.6f\n", t);

// NAppGUI struct set
clock_reset(clock);
for (uint32_t i = 0; i < n; ++i)
{
    // TODO: review 'setst_insert'. The copy makes the insertion slower
    Product *product = setst_insert(setst, &products[i], Product);
    *product = products[i];
}
t = clock_elapsed(clock);
bstd_printf("- Add to SetSt(Product): %.6f\n", t);

// STL struct set
clock_reset(clock);
for (uint32_t i = 0; i < n; ++i)
    stl_setst.insert(products[i]);
t = clock_elapsed(clock);
bstd_printf("- Add to set<Product>: %.6f\n", t);

// NAppGUI pointer set
clock_reset(clock);
for (uint32_t i = 0; i < n; ++i)
    setpt_insert(setpt, pproducts[i], Product);
t = clock_elapsed(clock);
bstd_printf("- Add to SetPt(Product): %.6f\n", t);

// STL pointer set
clock_reset(clock);
for (uint32_t i = 0; i < n; ++i)
    stl_setpt.insert(pproducts[i]);
t = clock_elapsed(clock);
bstd_printf("- Add to set<Product*>: %.6f\n", t);

// Verify the sorting correctness

```

```

clock_reset(clock);
arrst_foreach(product, arrst, Product)
    if (product->id != product_i)
        bstd_printf("- Sorting error!!!!\n");
arrst_end()
t = clock_elapsed(clock);
bstd_printf("- Loop ArrSt(Product): %.6f\n", t);

clock_reset(clock);
for (size_t i = 0; i < stl_arrst.size(); ++i)
{
    if (i != stl_arrst[i].id)
        bstd_printf("- Sorting error!!!!\n");
}
t = clock_elapsed(clock);
bstd_printf("- Loop vector<Product>: %.6f\n", t);

clock_reset(clock);
arrpt_foreach(product, arrpt, Product)
    if (product->id != product_i)
        bstd_printf("- Sorting error!!!!\n");
arrpt_end()
t = clock_elapsed(clock);
bstd_printf("- Loop ArrPt(Product): %.6f\n", t);

clock_reset(clock);
for (size_t i = 0; i < stl_arrpt.size(); ++i)
{
    if (i != stl_arrpt[i]->id)
        bstd_printf("- Sorting error!!!!\n");
}
t = clock_elapsed(clock);
bstd_printf("- Loop vector<Product*>: %.6f\n", t);

clock_reset(clock);
setst_foreach(product, setst, Product)
    if (product->id != product_i)
        bstd_printf("- Sorting error!!!!\n");
setst_fornext(product, setst, Product);
t = clock_elapsed(clock);
bstd_printf("- Loop SetSt<Product>: %.6f\n", t);

uint32_t ic = 0;
clock_reset(clock);
for (set<Product, i_stl_compare>::iterator i = stl_setst.begin(); i !=
    ↪ stl_setst.end(); ++i)
{
    if (i->id != ic++)
        bstd_printf("- Sorting error!!!!\n");
}
t = clock_elapsed(clock);

```

```

bstd_printf("- Loop set<Product>: %.6f\n", t);

clock_reset(clock);
setpt_foreach(product, setpt, Product)
    if (product->id != product_i)
        bstd_printf("- Sorting error!!!!\n");
setpt_fornext(product, setpt, Product);
t = clock_elapsed(clock);
bstd_printf("- Loop SetPt<Product>: %.6f\n", t);

ic = 0;
clock_reset(clock);
for (set<Product *, i_stl_compare>::iterator i = stl_setpt.begin(); i !=
    ↪ stl_setpt.end(); ++i)
{
    if ((*i)->id != ic++)
        bstd_printf("- Sorting error!!!!\n");
}
t = clock_elapsed(clock);
bstd_printf("- Loop set<Product*>: %.6f\n", t);

clock_destroy(&clock);
arrst_destroy(&arrst, NULL, Product);
arrpt_destroy(&arrpt, NULL, Product);
setst_destroy(&setst, NULL, Product);
setpt_destroy(&setpt, NULL, Product);

for (uint32_t i = 0; i < n; ++i)
    heap_delete(&products[i], Product);

heap_delete_n(&products, n, Product);
heap_delete_n(&pproducts, n, Product *);
heap_delete_n(&ids, n, uint32_t);

return 0;
}

```

Part 4

Library reference

Sewer library

38.1. Types and Constants

int8_t

8-bit signed integer. It can represent a value between `INT8_MIN` and `INT8_MAX`.

int16_t

16-bit signed integer. It can represent a value between `INT16_MIN` and `INT16_MAX`.

int32_t

32-bit signed integer. It can represent a value between `INT32_MIN` and `INT32_MAX`.

int64_t

64-bit signed integer. It can represent a value between `INT64_MIN` and `INT64_MAX`.

uint8_t

8-bit unsigned integer. It can represent a value between 0 and `UINT8_MAX`.

uint16_t

16-bit unsigned integer. It can represent a value between 0 and `UINT16_MAX`.

uint32_t

32-bit unsigned integer. It can represent a value between 0 and `UINT32_MAX`.

uint64_t

64-bit unsigned integer. It can represent a value between 0 and `UINT64_MAX`.

char_t

8-bit character type (Unicode). A single character may need 1, 2, 3 or 4 elements (bytes), depending on “*UTF encodings*” (page 163).

byte_t

8-bit type to store generic memory blocks.

bool_t

8-bit boolean. Only two values are allowed `TRUE` (1) and `FALSE` (0).

real

32 or 64-bit floating point number.

real32_t

32-bit floating point number. The C `float` type.

real64_t

64-bit floating point number. The C `double` type.

TRUE

True.

```
const bool_t TRUE = 1;
```

FALSE

False.

```
const bool_t FALSE = 0;
```

NULL

Null pointer.

```
const void* NULL = 0;
```

INT8_MIN

-128.

```
const int8_t INT8_MIN = 0x80;
```

INT8_MAX

127.

```
const int8_t INT8_MAX = 0x7F;
```

INT16_MIN

-32.768.

```
const int16_t INT16_MIN = 0x8000;
```

INT16_MAX

32.767.

```
const int16_t INT16_MAX = 0x7FFF;
```

INT32_MIN

-2.147.483.648.

```
const int32_t INT32_MIN = 0x80000000;
```

INT32_MAX

2.147.483.647.

```
const int32_t INT32_MAX = 0x7FFFFFFF;
```

INT64_MIN

-9.223.372.036.854.775.808.

```
const int64_t INT64_MIN = 0x8000000000000000;
```

INT64_MAX

9.223.372.036.854.775.807.

```
const int64_t INT64_MAX = 0x7FFFFFFFFFFFFFFF;
```

UINT8_MAX

255.

```
const uint8_t UINT8_MAX = 0xFF;
```

UINT16_MAX

65.535.

```
const uint16_t UINT16_MAX = 0xFFFF;
```

UINT32_MAX

4.294.967.295.

```
const uint32_t UINT32_MAX = 0xFFFFFFFF;
```

UINT64_MAX

18.446.744.073.709.551.615.

```
const uint64_t UINT64_MAX = 0xFFFFFFFFFFFFFFFF;
```

kE

Euler's number.

```
const real32_t kBMath_Ef = 2.718281828459045f;  
const real64_t kBMath_Ed = 2.718281828459045;  
const real BMath::kE;
```

kLN2

The natural logarithm of 2.

```
const real32_t kBMath_LN2f = 0.6931471805599453f;  
const real64_t kBMath_LN2d = 0.6931471805599453;  
const real BMath::kLN2;
```

kLN10

The natural logarithm of 10.

```
const real32_t kBMATH_LN10f = 2.302585092994046f;
const real64_t kBMATH_LN10d = 2.302585092994046;
const real BMath::kLN10;
```

kPI

The number Pi.

```
const real32_t kBMATH_PIf = 3.141592653589793f;
const real64_t kBMATH_PId = 3.141592653589793;
const real BMath::kPI;
```

kSQRT2

Square root of 2.

```
const real32_t kBMATH_SQRT2f = 1.414213562373095f;
const real64_t kBMATH_SQRT2d = 1.414213562373095;
const real BMath::kSQRT2;
```

kSQRT3

Square root of 3.

```
const real32_t kBMATH_SQRT3f = 1.732050807568878f;
const real64_t kBMATH_SQRT3d = 1.732050807568878;
const real BMath::kSQRT3;
```

kDEG2RAD

Conversion from one degree to radians.

```
const real32_t kBMATH_DEG2RADf = 0.017453292519943f;
const real64_t kBMATH_DEG2RADd = 0.017453292519943;
const real BMath::kDEG2RAD;
```

kRAD2DEG

Conversion of a radian to degrees.

```
const real32_t kBMATH_RAD2DEGf = 57.2957795130823f;
const real64_t kBMATH_RAD2DEGd = 57.2957795130823;
const real BMath::kRAD2DEG;
```

kINFINITY

Infinite, represented by a very large value.

```
const real32_t kBMath_INFINITYf = ∞f;
const real64_t kBMath_INFINITYd = ∞;
const real BMath::kINFINITY;
```

enum unicode_t

Represents the “*UTF encodings*” (page 163).

```
ekUTF8    UTF8 encoding.
ekUTF16   UTF16 encoding.
ekUTF32   UTF32 encoding.
```

struct REnv

“*Random numbers*” (page 166) environment.

```
struct REnv;
```

38.2. Functions

FPtr_destroy

Destructor function prototype.

```
void
(*FPtr_destroy)(type **item);
```

item Double pointer to the object to destroy. It must be assigned to `NULL` after the destruction to invalidate its use.

FPtr_copy

Copy constructor function prototype.

```
type*
(*FPtr_copy)(const type *item);
```

item Pointer to the object to be copied.

Return:

The new object that is an exact copy of the input.

FPtr_scopy

Unallocated memory copy constructor prototype.

```
void
(*FPtr_scopy) (type *dest,
               const type *src);
```

dest Destination object (copy).

src Pointer to the object to be copied (source).

Remarks:

In this copy operation, the memory required by the object has already been allocated. We must create dynamic memory for the fields of the object that require it, but not for the object itself. Usually used to copy arrays of objects (not pointers to objects).

FPtr_compare

Comparison function prototype.

```
int
(*FPtr_compare) (const type *item1,
                 const type *item2);
```

item1 First item to compare.

item2 Second item to compare.

Return:

Comparison result.

FPtr_compare_ex

Similar to `FPtr_compare`, but receive an additional parameter that may influence the comparison.

```
int
(*FPtr_compare_ex) (const type *item1,
                   const type *item2,
                   const dtype *data);
```

item1 First item to compare.

item2 Second item to compare.

data Additional parameter.

Return:

Comparison result.

FPtr_assert

Callback function prototype called when an assert occurs.

```
void
(*FPtr_assert)(type *item,
               const uint32_t group,
               const char_t *caption,
               const char_t *detail,
               const char_t *file,
               const uint32_t line);
```

item User data passed as the first parameter.

group 0 = Fatal error, 1 = Execution can continue.

caption Title.

detail Detailed message.

file Source file where the assert occurred.

line Line inside the source file.

unref

Mark the parameter as non-referenced, disabling the compiler's warnings.

```
void
unref(param);
```

```
static void i_OnClick(App *app, Event *e)
{
    unref(e);
    app_click_action(app);
}
```

param Parameter.

cassert

Basic *assert* sentence. If the condition is evaluated at **FALSE**, a “continuable” *assert* will be launched. The message shown will be the literal of the condition itself.

```
void
cassert(bool_t cond);
```

```
// "row < arrpt_size(layout->rows)"
// will be shown in the assert window
cassert(row < arrpt_size(layout->rows));
```

cond Boolean expression.

cassert_msg

Same as the `cassert()` sentence, but using a custom message, instead of the literal condition.

```
void
cassert_msg(bool_t cond,
            const char_t *msg);
```

```
// "'row' out of range"
// will be shown in the assert window
cassert_msg(layout < layout->num_rows, "'row' out of range");
```

cond Boolean expression.

msg Message related to the *assert*.

cassert_fatal

Same as the `cassert()` sentence, but throwing a **critical** assert (not “continuable”).

```
void
cassert_fatal(bool_t cond);
```

```
// "gravity > 0."
// will be shown in the assert window
cassert_fatal(gravity > 0.);
```

cond Boolean expression.

cassert_fatal_msg

Same as the `cassert_msg()` sentence, but throwing a **critical** assert (not “continuable”).

```
void
cassert_fatal_msg(bool_t cond,
                 const char_t *msg);
```

```
// "'gravity' can't be negative."
// will be shown in the assert window
cassert_fatal_msg(gravity > 0., "'gravity' can't be negative");
```

cond Boolean expression.
 msg Message related to the *assert*.

cassert_no_null

Triggers a critical *assert* if a pointer has `NULL` value.

```
void
cassert_no_null(void *ptr);
```

ptr Pointer to evaluate.

cassert_no_nullf

Triggers a critical *assert* if a **function** pointer has `NULL` value.

```
void
cassert_no_nullf(void *fptr);
```

fptr Pointer to evaluate.

cassert_default

Triggers a “continuable” *assert* if the **switch** statement reaches the `default:` state. Useful to ensure that, for example, all the values of an enum have been considered.

```
void
cassert_default(void);
```

```
switch(alien) {
case LEFT:
    // Do something
    break;
case RIGHT:
    // Do something
    break;
// Others are not allowed.
cassert_default();
}
```

cassert_set_func

Set a custom function to execute an alternative code when an *assert* occurs. By default, in desktop applications, an informative window is displayed (Figure 13.4) and the message is saved in a “Log” (page 192) file.

```
void
cassert_set_func(void *data,
                 FPtr_assert func_assert);
```

data User data or application context.

func_assert *Callback* function called after the activation of an *assert*.

Remarks:

When using this function, the previous *asserts* management will be deactivated.

ptr_get

Access to the content of the pointer (dereference), verifying previously that it is not `NULL`.

```
void
ptr_get(type *ptr,
        type);
```

```
void compute(const V2Df *v1, const V2Df *v2)
{
    /* Safer than t = *v1; */
    V2Df t = ptr_get(v1, V2Df);
    ...
}
```

ptr Pointer.

type Pointer type.

ptr_dget

Access the content of a double pointer, invalidating it later.

```
void
ptr_dget(type **ptr,
         type);
```

```
Ctrl *create(Model **model, View **view)
{
    Ctrl *ctrl = heap_new(Ctrl);
    ctrl->model = ptr_dget(model, Model);
    ctrl->view = ptr_dget(view, View);
    // *model = NULL
    // *view = NULL
    return ctrl;
}
```

ptr Double pointer.

type Pointer type.

ptr_dget_no_null

Like `ptr_dget`, but the content of the double pointer (`*dptr`) can not be `NULL`.

```
void
ptr_dget_no_null(type **ptr,
                type);
```

```
Ctrl *create(Model **model, View **view)
{
    // *model and *view can't be NULL
    Ctrl *ctrl = heap_new(Ctrl);
    ctrl->model = ptr_dget_no_null(model, Model);
    ctrl->view = ptr_dget_no_null(view, View);
    return ctrl;
}
```

ptr Double pointer.

type Pointer type.

ptr_assign

Assign content from one pointer to another, if the destination is not `NULL`.

```
void
ptr_assign(dest,
          src);
```

dest Destination pointer.

src Source pointer.

ptr_destopt

Destroy an object if not `NULL`.

```
void
ptr_destopt(FPtr_destroy func_destroy,
            type dptr,
            type);
```

```
cassert_no_null(dptr);
if (*dptr != NULL)
{
```

```

func_destroy(*dptr);
*dptr = NULL;
}

```

`func_destroy` Destructor.

`dptr` Double pointer to the object to destroy.

`type` Object type.

ptr_copyopt

Copy the object if not `NULL`.

```

void
ptr_copyopt(FPtr_copy func_copy,
            type ptr,
            type);

```

```

if (ptr != NULL)
    return func_copy(ptr);
else
    return NULL;

```

`func_copy` Copy constructor.

`ptr` Object to copy (source).

`type` Object type.

unicode_convers

Converts a Unicode string from one encoding to another.

```

uint32_t
unicode_convers(const char_t *from_str,
                char_t *to_str,
                const unicode_t from,
                const unicode_t to,
                const uint32_t osize);

```

```

const char32_t str[] = U"Hello World";
char_t utf8_str[256];
unicode_convers((const char_t*)str, utf8_str, ekUTF32, ekUTF8, 256);

```

from_str Source string (terminated in null character '\0').
to_str Destination buffer.
from Source string encoding.
to Coding required in **to_str**.
osize Size of the output buffer. Maximum number of bytes that will be written in **to_str**, including the null character ('\0'). If the original string can not be copied entirely, it will be cutted and the null character added.

Return:

Number of bytes written in **to_str** (including the null character).

unicode_convers_n

Like **unicode_convers**, but indicating a maximum size for the input string.

```

uint32_t
unicode_convers_n(const char_t *from_str,
                 char_t *to_str,
                 const unicode_t from,
                 const unicode_t to,
                 const uint32_t isize,
                 const uint32_t osize);
  
```

from_str Source string.
to_str Destination buffer.
from Source string encoding.
to Coding required in **to_str**.
isize Size of the input string (in bytes).
osize Size of the output buffer.

Return:

Number of bytes written in **to_str** (including the null character).

unicode_convers_nbytes

Gets the number of bytes needed to convert a Unicode string from one encoding to another. It will be useful to calculate the space needed in dynamic memory allocation.

```

uint32_t
unicode_convers_nbytes(const char_t *str,
                      const unicode_t from,
                      const unicode_t to);
  
```

```

const char32_t str[] = U"Hello World";
uint32_t size = unicode_convers_nbytes((char_t*)str, ekUTF32, ekUTF8);
/ * size == 12 * /

```

str Origin string (null-terminated).
 from Encoding of str.
 to Required encoding.

Return:

Number of bytes required (including the null character).

unicode_convers_nbytes_n

Same as `unicode_convers_nbytes`, but indicating the size of the source string.

```

uint32_t
unicode_convers_nbytes_n(const char_t *str,
                        const uint32_t isize,
                        const unicode_t from,
                        const unicode_t to);

```

str Origin string. It is not necessary null-terminated.
 isize Size of the input string in bytes.
 from Encoding of str.
 to Required encoding.

Return:

Number of bytes required (including the null character).

unicode_nbytes

Gets the size (in bytes) of a Unicode string.

```

uint32_t
unicode_nbytes(const char_t *str,
              const unicode_t format);

```

str Unicode string (null-terminated `'\0'`).
 format Encoding of str.

Return:

The size in bytes (including the null character).

unicode_nchars

Gets the length (in characters) of a Unicode string.

```
uint32_t
unicode_nchars(const char_t *str,
               const unicode_t format);
```

str Unicode string (null-terminated '\0').

format Encoding of str.

Return:

The number of characters ('\0' **not included**).

Remarks:

In ASCII strings, the number of bytes is equal to the number of characters. In Unicode it depends on the coding and the string.

unicode_to_u32

Gets the value of the first *codepoint* of the Unicode string.

```
uint32_t
unicode_to_u32(const char_t *str,
               const unicode_t format);
```

```
char_t str[] = "áéíóúÃÑ&";
uint32_t cp = unicode_to_u32(str, ekUTF8);
/* cp == 'á' == 225 == U+E1 */
```

str Unicode string (null-terminated '\0').

format Encoding of str.

Return:

The code of the first str character.

unicode_to_u32b

Like `unicode_to_u32` but with an additional field to store the number of bytes occupied by the codepoint.

```
uint32_t
unicode_to_u32b(const char_t *str,
                const unicode_t format,
                uint32_t *bytes);
```

`str` Unicode string (null-terminated `'\0'`).
`format` Encoding of `str`.
`bytes` Saves the number of bytes needed to represent the codepoint by `format`.

Return:

The code of the first `str` character.

unicode_to_char

Write the codepoint at the beginning of `str`, using the `format` encoding.

```
uint32_t
unicode_to_char(const uint32_t codepoint,
               char_t *str,
               const unicode_t format);
```

```
char_t str[64] = "\\\"";
uint32_t n = unicode_to_char(0xE1, str, ekUTF8);
unicode_to_char(0, str + n, ekUTF8);
/* str == "á" */
/* n = 2 */
```

`codepoint` Character code.
`str` Destination string.
`format` Encoding for codepoint.

Return:

The number of bytes written (1, 2, 3 or 4).

Remarks:

To write several *codepoints*, combine `unicode_to_char` with `unicode_next`.

unicode_valid_str

Check if a string is a valid Unicode.

```
bool_t
unicode_valid_str(const char_t *str,
                 const unicode_t format);
```

`str` String to be checked (ending in `'\0'`).
`format` Expected Unicode encoding.

Return:

`TRUE` if it is valid.

unicode_valid_str_n

Like `unicode_valid_str`, but indicating a maximum size for the input string.

```
bool_t
unicode_valid_str_n(const char_t *str,
                   const uint32_t size,
                   const unicode_t format);
```

`str` String to be checked (ending in `'\0'`).

`size` Maximum size of the string (in bytes).

`format` Expected Unicode encoding.

Return:

`TRUE` if it is valid.

unicode_valid

Check if a *codepoint* is valid.

```
bool_t
unicode_valid(const uint32_t codepoint);
```

`codepoint` The Unicode code of the character.

Return:

`TRUE` if the parameter is a valid *codepoint*. `FALSE` otherwise.

unicode_next

Advance to the next character in a Unicode string. In general, random access is not possible as we do in ANSI-C (`str[i++]`). We must iterate a string from the beginning. More in “*UTF encodings*” (page 163).

```
const char_t*
unicode_next(const char_t *str,
             const unicode_t format);
```

```
char_t str[] = "áéíóúÄ";
char_t *iter = str;           /* iter == "áéíóúÄ" */
iter = unicode_next(iter, ekUTF8); /* iter == "éíóúÄ" */
iter = unicode_next(iter, ekUTF8); /* iter == "íóúÄ" */
```

```

iter = unicode_next(iter, ekUTF8); /* iter == "óúÄ" */
iter = unicode_next(iter, ekUTF8); /* iter == "úÄ" */
iter = unicode_next(iter, ekUTF8); /* iter == "Ä" */
iter = unicode_next(iter, ekUTF8); /* iter == "" */
iter = unicode_next(iter, ekUTF8); /* Segmentation fault!! */

```

str Unicode string.

format str encoding.

Return:

Pointer to the next character in the string.

Remarks:

It does not verify the end of the string. We must stop the iteration when `codepoint == 0`.

unicode_back

Go back to the previous character of a Unicode string.

```

const char_t*
unicode_back(const char_t *str,
             const unicode_t format);

```

str Unicode string.

format str encoding.

Return:

Pointer to the previous character of the string.

Remarks:

It does not verify the beginning of the string.

unicode_move

Advances `nchars` characters from a Unicode string. Equivalent to several calls to `unicode_next`.

```

const char_t*
unicode_move(const char_t *str,
             const uint32_t nchars,
             const unicode_t format);

```

```

char_t str[] = "áéíóúÄ";
char_t *iter = str;                               /* iter == "áéíóúÄ" */
iter = unicode_move(iter, 4, ekUTF8);             /* iter == "úÄ" */
iter = unicode_move(iter, 20, ekUTF8);           /* iter == "" */

```

str Unicode string.

nchars Number of characters to advance.

format str encoding.

Return:

Pointer to the numbered nchars character in the string.

Remarks:

If the string has fewer than nchars characters, it will return the null character '\0'. It will not advance beyond the buffer limits.

unicode_isascii

Check if codepoint is a US-ASCII 7 character.

```

bool_t
unicode_isascii(const uint32_t codepoint);

```

codepoint The Unicode character code.

Return:

Test result.

unicode_isalnum

Check if codepoint is an alphanumeric character.

```

bool_t
unicode_isalnum(const uint32_t codepoint);

```

codepoint The Unicode character code.

Return:

Test result.

Remarks:

Only consider US-ASCII characters.

unicode_isalpha

Check if `codepoint` is an alphabetic character.

```
bool_t  
unicode_isalpha(const uint32_t codepoint);
```

`codepoint` The Unicode character code.

Return:

Test result.

Remarks:

Only consider US-ASCII characters.

unicode_iscntrl

Check if `codepoint` is a control character.

```
bool_t  
unicode_iscntrl(const uint32_t codepoint);
```

`codepoint` The Unicode character code.

Return:

Test result.

Remarks:

Only consider US-ASCII characters.

unicode_isdigit

Check if `codepoint` is digit (0-9).

```
bool_t  
unicode_isdigit(const uint32_t codepoint);
```

`codepoint` The Unicode character code.

Return:

Test result.

Remarks:

Only consider US-ASCII characters.

unicode_isgraph

Check if `codepoint` is a printable character (except white space ' ').

```
bool_t  
unicode_isgraph(const uint32_t codepoint);
```

`codepoint` The Unicode character code.

Return:

Test result.

Remarks:

Only consider US-ASCII characters.

unicode_isprint

Check if `codepoint` is a printable character (including white space ' ').

```
bool_t  
unicode_isprint(const uint32_t codepoint);
```

`codepoint` The Unicode character code.

Return:

Test result.

Remarks:

Only consider US-ASCII characters.

unicode_ispunct

Check if `codepoint` is a printable character (except white space ' ' and alphanumeric).

```
bool_t  
unicode_ispunct(const uint32_t codepoint);
```

`codepoint` The Unicode character code.

Return:

Test result.

Remarks:

Only consider US-ASCII characters.

unicode_isspace

Check if `codepoint` is a spacing character, new line, carriage return, horizontal or vertical tab.

```
bool_t
unicode_isspace(const uint32_t codepoint);
```

`codepoint` The Unicode character code.

Return:

Test result.

Remarks:

Only consider US-ASCII characters.

unicode_isxdigit

Check if `codepoint` is a hexadecimal digit **0 1 2 3 4 5 6 7 8 9 a b c d e f A B C D E F**.

```
bool_t
unicode_isxdigit(const uint32_t codepoint);
```

`codepoint` The Unicode character code.

Return:

Test result.

Remarks:

Only consider US-ASCII characters.

unicode_islower

Check if `codepoint` is a lowercase letter.

```
bool_t
unicode_islower(const uint32_t codepoint);
```

`codepoint` The Unicode character code.

Return:

Test result.

Remarks:

Only consider US-ASCII characters.

unicode_isupper

Check if codepoint is a capital letter.

```
bool_t  
unicode_isupper(const uint32_t codepoint);
```

codepoint The Unicode character code.

Return:

Test result.

Remarks:

Only consider US-ASCII characters.

unicode_tolower

Convert a letter to lowercase.

```
uint32_t  
unicode_tolower(const uint32_t codepoint);
```

codepoint The Unicode character code.

Return:

The conversion to lowercase if the entry is a capital letter. Otherwise, the same codepoint.

Remarks:

Only consider US-ASCII characters.

unicode_toupper

Convert a letter to uppercase.

```
uint32_t  
unicode_toupper(const uint32_t codepoint);
```

codepoint The Unicode character code.

Return:

The conversion to upper case if the entry is a lowercase letter. Otherwise, the same codepoint.

Remarks:

Only consider US-ASCII characters.

bm_{math}_cos

Get the cosine of an angle.

```
real32_t
bmmath_cosf(const real32_t angle);

real64_t
bmmath_cosd(const real64_t angle);

real
BMath::cos(const real angle);
```

angle Angle in radians.

Return:

The cosine of the angle.

bm_{math}_sin

Get the sine of an angle.

```
real32_t
bmmath_sinf(const real32_t angle);

real64_t
bmmath_sind(const real64_t angle);

real
BMath::sin(const real angle);
```

angle Angle in radians.

Return:

The sine of the angle.

bm_{math}_tan

Get the tangent of an angle.

```

real32_t
bmath_tanf(const real32_t angle);

real64_t
bmath_tand(const real64_t angle);

real
BMath::tan(const real angle);

```

angle Angle in radians.

Return:

The angle tangent.

bmath_acos

Get the cosine arc, or inverse cosine, which is the angle whose cosine is the value.

```

real32_t
bmath_acosf(const real32_t cos);

real64_t
bmath_acosd(const real64_t cos);

real
BMath::acos(const real cos);

```

cos Cosine (-1, 1).

Return:

The angle (0, Pi).

bmath_asin

Get the sine arc, or inverse sine, which is the angle whose sine is the value.

```

real32_t
bmath_asinf(const real32_t sin);

real64_t
bmath_asind(const real64_t sin);

real
BMath::asin(const real sin);

```

sin Sine (-1, 1).

Return:

The angle $(0, \text{Pi})$.

bm_{math}_atan2

Get the tangent arc, or inverse tangent. Es is the angle measured from the X axis to the line containing the origin $(0, 0)$ and the point with the coordinates (x, y) .

```
real32_t
bmmath_atan2f(const real32_t y,
              const real32_t x);

real64_t
bmmath_atan2d(const real64_t y,
              const real64_t x);

real
BMmath::atan2(const real y,
              const real x);
```

y Y coordinate.

x Coordinate X.

Return:

The angle $(-\text{Pi}, \text{Pi})$.

bm_{math}_norm_angle

Normalizes an angle, that is, it returns the same angle expressed in the range $(-\text{Pi}, \text{Pi})$.

```
real32_t
bmmath_norm_anglef(const real32_t a);

real64_t
bmmath_norm_angled(const real64_t a);

real
BMmath::norm_angle(const real a);
```

a The angle in radians.

Return:

The angle $(-\text{Pi}, \text{Pi})$.

bmath_sqrt

Get the square root of a number.

```

real32_t
bmath_sqrtf(const real32_t value);

real64_t
bmath_sqrtld(const real64_t value);

real
BMath::sqrt(const real value);

```

value The number.

Return:

The square root.

bmath_isqrt

Get the inverse square root of a number (1/sqrt).

```

real32_t
bmath_isqrtf(const real32_t value);

real64_t
bmath_isqrtld(const real64_t value);

real
BMath::isqrt(const real value);

```

value The number.

Return:

The inverse square root.

bmath_log

Get the natural logarithm (base e) of a number.

```

real32_t
bmath_logf(const real32_t value);

real64_t
bmath_logld(const real64_t value);

real
BMath::log(const real value);

```

value The number.

Return:

The logarithm.

bmath_log10

Get the logarithm in base 10 of a number.

```
real32_t
bmath_log10f(const real32_t value);

real64_t
bmath_log10d(const real64_t value);

real
BMath::log10(const real value);
```

value The number.

Return:

The logarithm.

bmath_exp

Get the number of Euler e (2.7182818) raised to a power.

```
real32_t
bmath_expf(const real32_t value);

real64_t
bmath_expd(const real64_t value);

real
BMath::exp(const real value);
```

value The exponent.

Return:

The exponential.

bmath_pow

Calculate a power, base raised to exponent.

```
real32_t
bmath_powf(const real32_t base,
```

```

        const real32_t exponent);

real64_t
bmath_powd(const real64_t base,
           const real64_t exponent);

real
BMath::pow(const real base,
           const real exponent);

```

base Base.

exponent Exponent.

Return:

The result of the power.

bmath_abs

Get the absolute value of a number.

```

real32_t
bmath_absf(const real32_t value);

real64_t
bmath_absd(const real64_t value);

real
BMath::abs(const real value);

```

value The number.

Return:

The absolute value.

bmath_max

Get the maximum of two values.

```

real32_t
bmath_maxf(const real32_t value1,
           const real32_t value2);

real64_t
bmath_maxd(const real64_t value1,
           const real64_t value2);

real
BMath::max(const real value1,

```

```
const real value2);
```

value1 First number.

value2 Second number.

Return:

The maximum value.

bmath_min

Get the minimum of two values.

```
real32_t
bmath_minf(const real32_t value1,
           const real32_t value2);

real64_t
bmath_mind(const real64_t value1,
           const real64_t value2);

real
BMath::min(const real value1,
           const real value2);
```

value1 First number.

value2 Second number.

Return:

The minimum value.

bmath_clamp

Restrict a value to a certain range.

```
real32_t
bmath_clampf(const real32_t value,
             const real32_t min,
             const real32_t max);

real64_t
bmath_clampd(const real64_t value,
             const real64_t min,
             const real64_t max);

real
BMath::clamp(const real value,
             const real min,
```



```
const real max);
```

value The number.

min Minimum value of the range.

max Maximum value of the range.

Return:

The limited value.

bmath_mod

Get the module of divide num/den.

```
real32_t
bmath_modf(const real32_t num,
           const real32_t den);

real64_t
bmath_modd(const real64_t num,
           const real64_t den);

real
BMath::mod(const real num,
           const real den);
```

num Numerator.

den Denominator.

Return:

The module.

bmath_modf

Get the integer and fraction part of a real number.

```
real32_t
bmath_modff(const real32_t value,
            real32_t *intpart);

real64_t
bmath_modfd(const real64_t value,
            real64_t *intpart);

real
BMath::modf(const real value,
            real *intpart);
```

value The number.

intpart Get the integer part.

Return:

The fractional part $[0, 1)$.

bmath_prec

Get the number of decimals (precision) of a real number.

```
uint32_t
bmath_precl(const real32_t value);

uint32_t
bmath_precl(const real64_t value);

uint32_t
BMath::prec(const real value);
```

value The number.

Return:

The number of decimal places.

bmath_round

Rounds a number to the nearest integer (above or below).

```
real32_t
bmath_roundf(const real32_t value);

real64_t
bmath_roundl(const real64_t value);

real
BMath::round(const real value);
```

value The number.

Return:

The nearest whole.

bmath_round_step

Round a number to the nearest fraction.

```

real32_t
bmath_round_stepf(const real32_t value,
                  const real32_t step);

real64_t
bmath_round_stepd(const real64_t value,
                  const real64_t step);

real
BMath::round_step(const real value,
                  const real step);

```

value The number.

step The fraction.

Return:

The nearest number.

bmath_floor

Rounds a number to the integer below.

```

real32_t
bmath_floorf(const real32_t value);

real64_t
bmath_floord(const real64_t value);

real
BMath::floor(const real value);

```

value The number.

Return:

The largest integer number, less than or equal to the number.

bmath_ceil

Round a number to the integer above.

```

real32_t
bmath_ceilf(const real32_t value);

real64_t
bmath_ceilid(const real64_t value);

real

```

```
BMath::ceil(const real value);
```

value The number.

Return:

The smallest integer number, greater than or equal to the number.

bmath_rand_seed

Establish a new seed of random numbers.

```
void
bmath_rand_seed(const uint32_t seed);
```

seed The new seed.

Remarks:

Each time the seed changes, a new sequence of random numbers begins. For the same seed, we will get the same sequence, so they are pseudo-random numbers. Similar seeds (eg. 4, 5) produce radically different sequences. Use `bmath_rand_env` in multi-threaded applications.

bmath_rand

Gets a random real number, within an interval.

```
real32_t
bmath_randf(const real32_t from,
            const real32_t to);

real64_t
bmath_randed(const real64_t from,
            const real64_t to);

real
BMath::rand(const real from,
            const real to);
```

from The lower limit of the interval.

to The upper limit of the interval.

Return:

The random number.

bmath_randi

Gets a random number, within an interval.

```
uint32_t
bmath_randi(const uint32_t from,
            const uint32_t to);
```

from The lower limit of the interval.

to The upper limit of the interval.

Return:

The random number.

bmath_rand_env

Create *thread-safe* environment for random numbers.

```
REnv*
bmath_rand_env(const uint32_t seed);
```

seed The seed.

Return:

The environment.

bmath_rand_destroy

Destroy an environment of random numbers.

```
void
bmath_rand_destroy(REnv **env);
```

env The environment. Will be set to `NULL` after destruction.

bmath_rand_mt

Gets a random real number, within an interval.

```
real32_t
bmath_rand_mtf(REnv *env,
               const real32_t from,
               const real32_t to);

real64_t
bmath_rand_mtd(REnv *env,
               const real64_t from,
```

```

        const real64_t to);

real
BMath::rand_mt(REnv *env,
               const real from,
               const real to);

```

env The random number environment.

from The lower limit of the interval.

to The upper limit of the interval.

Return:

The random number.

bmath_rand_mti

Gets a random number, within an interval.

```

uint32_t
bmath_rand_mti(REnv *env,
               const uint32_t from,
               const uint32_t to);

```

env The random number environment.

from The lower limit of the interval.

to The upper limit of the interval.

Return:

The random number.

blib_strlen

Returns the length in bytes of a text string.

```

uint32_t
blib_strlen(const char_t *str);

```

str String terminated with null character '\0'.

Return:

String length not including the null character.

Remarks:

See “Unicode” (page 161), the number of bytes is not equivalent to the number of characters.

blib_strstr

Find a substring within a longer string.

```
const char_t*
blib_strstr(const char_t *str,
            const char_t *substr);
```

str String terminated with null character '\0'.

substr Substring to search ending in null character '\0'.

Return:

Pointer to the start of the first substring found or **NULL** if none exists.

blib_strcpy

Copy the content of one string to another.

```
void
blib_strcpy(char_t *dest,
            const uint32_t size,
            const char_t *src);
```

dest Destiny buffer.

size Destination buffer size in bytes.

src String to copy ending in null character '\0'.

Remarks:

Only the first `size-1` bytes will be copied, in case `src` is longer than the capacity of `dest`.

blib_strncpy

Copy the first `n` bytes of one string to another.

```
void
blib_strncpy(const char_t *dest,
            const uint32_t size,
            const char_t *src,
            const uint32_t n);
```

- dest Destiny buffer.
- size Destination buffer size in bytes.
- src String to copy ending in null character `'\0'`.
- n Number of bytes to copy.

Remarks:

Only the first `size-1` bytes will be copied, in case `n` is greater than `size`.

blib_strcat

Concatenation of strings.

```
void
blib_strcat(char_t *dest,
            const uint32_t size,
            const char_t *src);
```

- dest Source and destination buffer.
- size Destination buffer size in bytes.
- src String to add to `dest`, terminated with null character `'\0'`.

Remarks:

The `size-1` bytes in `dest` will not be exceeded, so the concatenation will be truncated if necessary.

blib_strcmp

Compare two strings.

```
int
blib_strcmp(const char_t *str1,
            const char_t *str2);
```

- str1 First string to compare, terminated with null character `'\0'`.
- str2 Second string to compare, terminated with null character `'\0'`.

Return:

Comparison Result.

blib_strncmp

Compare the first `n` bytes of two strings.

```
int
bllib_strncmp(const char_t *str1,
              const char_t *str2,
              const uint32_t n);
```

- str1 First string to compare, terminated with null character '\0'.
- str2 Second string to compare, terminated with null character '\0'.
- n Maximum number of bytes to compare.

Return:

Comparison Result.

bllib_strftime

Transforms a date into a text string, using the strftime format.

```
uint32_t
bllib_strftime(char_t *dest,
               const uint32_t size,
               const char_t *format,
               const int16_t year,
               const uint8_t month,
               const uint8_t mday,
               const uint8_t wday,
               const uint8_t hour,
               const uint8_t minute,
               const uint8_t second);
```

- dest Pointer to the buffer where the result will be written. Will terminate in null character '\0'.
- size Size of dest in bytes.
- format Format the string with the date.
- year Year.
- month Month number (1,12).
- mday Day of the month (1,31).
- wday Weekday (0,6). 0=Sunday.
- hour Hour (0,23).
- minute Minute (0,59).
- second Second (0,59).

Return:

The number of bytes written to `dest`, not including the character `'\0'`. If the string does not fit in `dest` it returns 0.

Remarks:

See “*Date conversion*” (page 167).

blib_strtol

Convert a text string to an integer.

```
int64_t
blib_strtol(const char_t *str,
            char_t **endptr,
            uint32_t base,
            bool_t *err);
```

`str` String starting with an integer.

`endptr` Pointer whose value will be the first character after the number. Can be `NULL`.

`base` Number base: 2, 8, 10, 16.

`err` Value `TRUE` is assigned if there is an error in the parsing of the string. Can be `NULL`.

Return:

String parsing result number.

blib_strtoul

Convert a text string to an unsigned integer.

```
uint64_t
blib_strtoul(const char_t *str,
             char_t **endptr,
             uint32_t base,
             bool_t *err);
```

`str` String starting with an integer.

`endptr` Pointer whose value will be the first character after the number. Can be `NULL`.

`base` Number base: 2, 8, 10, 16.

`err` Value `TRUE` is assigned if there is an error in the parsing of the string. Can be `NULL`.

Return:

String parsing result number.

blib_strtof

Convert a text string to a 32-bit real number.

```
real32_t
blib_strtof(const char_t *str,
            char_t **endptr,
            bool_t *err);
```

str String starting with an real number.

endptr Pointer whose value will be the first character after the number. Can be `NULL`.

err Value `TRUE` is assigned if there is an error in the parsing of the string. Can be `NULL`.

Return:

String parsing result number.

blib_strtod

Convert a text string to a 32-bit real number.

```
real64_t
blib_strtod(const char_t *str,
            char_t **endptr,
            bool_t *err);
```

str String starting with an real number.

endptr Pointer whose value will be the first character after the number. Can be `NULL`.

err Value `TRUE` is assigned if there is an error in the parsing of the string. Can be `NULL`.

Return:

String parsing result number.

blib_qsort

Sorts a vector of elements using the *QuickSort* algorithm.

```

void
blib_qsort(byte_t *array,
           const uint32_t nelems,
           const uint32_t size,
           FPtr_compare func_compare);

```

array Vector of elements.
 nelems Number of elements.
 size Size of each element.
 func_compare Comparison function.

blib_qsort_ex

Sorts a vector of elements using the *QuickSort* algorithm.

```

void
blib_qsort_ex(byte_t *array,
              const uint32_t nelems,
              const uint32_t size,
              FPtr_compare_ex func_compare,
              const byte_t *data);

```

array Vector of elements.
 nelems Number of elements.
 size Size of each element.
 func_compare Compare function that accepts extra data.
 data Extra data that will be passed in each comparison.

blib_bsearch

Search for an element in an ordered vector.

```

bool_t
blib_bsearch(const byte_t *array,
             const byte_t *key,
             const uint32_t nelems,
             const uint32_t size,
             FPtr_compare func_compare,
             uint32_t *pos);

```

array Vector of elements.
 key Search key.
 nelems Number of elements.
 size Size of each element.
 func_compare Comparison function.
 pos Position of the found element. It can be `NULL`.

Return:

`TRUE` if the element was found.

blib_bsearch_ex

Search for an element in an ordered vector.

```

bool_t
blib_bsearch_ex(const byte_t *array,
               const byte_t *key,
               const uint32_t nelems,
               const uint32_t size,
               FPtr_compare_ex func_compare,
               const byte_t *data,
               uint32_t *pos);

```

array Vector of elements.
 key Search key.
 nelems Number of elements.
 size Size of each element.
 func_compare Compare function that accepts extra data.
 data Extra data that will be passed in each comparison.
 pos Position of the found element. It can be `NULL`.

Return:

`TRUE` if the element was found.

blib_getenv

Gets the value of an environment variable.

```
const char_t*
blib_getenv(const char_t *name);
```

name The name of the variable.

Return:

The value of the variable. `NULL` if said variable does not exist.

blib_setenv

Sets the value of an environment variable.

```
int32_t
blib_setenv(const char_t *name,
            const char_t *value);
```

name The name of the variable.

value The value of the variable.

Return:

0 if set correctly. Otherwise, an error code.

Remarks:

If the variable already exists, its value will be overwritten.

blib_atexit

Add a function that will be called when the program ends.

```
void
blib_atexit(void() (void) *func);
```

func Function.

blib_abort

The execution of the program ends abruptly.

```
void
blib_abort(void);
```

Remarks:

No resources are released or a controlled shutdown is performed. The only case where its use is justified is to exit the program after detecting an unrecoverable error (eg `NULL` pointer).

`blib_exit`

Terminates a process.

```
void
blib_exit(int code);
```

`code` Return code.

`blib_debug_break`

Stops program execution at the point where the function is located and returns debugger control so we can inspect the stack, variables, etc.

```
void
blib_debug_break(void);
```

`bstd_sprintf`

Write a string with the `printf` format in a memory buffer.

```
uint32_t
bstd_sprintf(char_t *str,
             const uint32_t size,
             const char_t *format,
             ...);
```

`str` Pointer to the buffer where the result will be written. It will end in a null character `'\0'`.

`size` Size of `str` in bytes.

`format` String with the `printf`-like format with a variable number of parameters.

`...` Arguments or variables of `printf`.

Return:

The number of bytes written, not including the null character `'\0'`.

Remarks:

It is a safe function and will not write more than `size` bytes. To obtain the necessary size of `str`, call this function with `str=NULL` and `size=0`.

bstd_vsprintf

Like `bstd_sprintf` but with the list of arguments already resolved.

```
uint32_t
bstd_vsprintf(char_t *str,
              const uint32_t size,
              const char_t *format,
              va_list args);
```

`str` Pointer to the buffer where the result will be written. It will end in a null character `'\0'`.

`size` Size of `str` in bytes.

`format` String with the printf-like format with a variable number of parameters.

`args` Arguments.

Return:

The number of bytes written, not including the null character `'\0'`.

Remarks:

It is a safe function and will not write more than `size` bytes.

bstd_printf

Writes a formatted string in the standard output (`stdout`). It is equivalent to the function `printf` from the standard library.

```
uint32_t
bstd_printf(const char_t *format,
           ...);
```

`format` String with the printf-like format with a variable number of parameters.

`...` Arguments or variables of printf.

Return:

The number of bytes written in `stdout`.

bstd_eprintf

Writes a formatted string in the error output (`stderr`).

```
uint32_t
bstd_eprintf(const char_t *format,
            ...);
```

format String with the printf-like format with a variable number of parameters.
 ... Arguments or variables of printf.

Return:

The number of bytes written in `stderr`.

bstd_writeln

Write a string C UTF8 in the standard output (`stdout`).

```
uint32_t
bstd_writeln(const char_t *str);
```

str String C UTF8 ending in null character '\0'.

Return:

The number of bytes written in `stdout`.

bstd_ewriteln

Write a string C UTF8 on the error output (`stderr`).

```
uint32_t
bstd_ewriteln(const char_t *str);
```

str String C UTF8 ending in null character '\0'.

Return:

The number of bytes written in `stderr`.

bstd_read

Read data from standard input `stdin`.

```
bool_t
bstd_read(byte_t *data,
          const uint32_t size,
          uint32_t *rsize);
```

data Buffer where the read data will be written.

size The number of maximum bytes to read (buffer size).

rsize Receive the number of bytes actually read. Can be `NULL`.

Return:

`TRUE` if data has been read. `FALSE` if any error has occurred.

Remarks:

“*Standard stream*” (page 204) implements high-level functions for reading/writing on standard channels.

bstd_write

Write data in the standard output `stdout`.

```
bool_t
bstd_write(const byte_t *data,
           const uint32_t size,
           uint32_t *wsize);
```

`data` Buffer that contains the data to write.

`size` The number of bytes to write.

`wsize` It receives the number of bytes actually written. Can be `NULL`.

Return:

`TRUE` if data has been written. `FALSE` if any error has occurred.

Remarks:

“*Standard stream*” (page 204) implements high-level functions for reading/writing on standard channels.

bstd_ewrite

Write data in the error output `stderr`.

```
bool_t
bstd_ewrite(const byte_t *data,
            const uint32_t size,
            uint32_t *wsize);
```

`data` Buffer that contains the data to write.

`size` The number of bytes to write.

`wsize` It receives the number of bytes actually written. Can be `NULL`.

Return:

`TRUE` if data has been written. `FALSE` if any error has occurred.

Remarks:

“*Standard stream*” (page 204) implements high-level functions for reading/writing on standard channels.

bmem_malloc

Reserve a memory block with the default alignment `sizeof(void*)`.

```
byte_t*
bmem_malloc(const uint32_t size);
```

size Size in bytes of the block.

Return:

Pointer to the new block. Must be released with `bmem_free` when it is no longer necessary.

Remarks:

Use “*Heap - Memory manager*” (page 196) for more efficient and secure allocations.

bmem_realloc

Reallocs an existing memory block due to the expansion or reduction of it. Guarantees that the previous content of the block is preserved `min(size, new_size)`. Try to do it without moving memory (in situ), but if it is not possible look for a new zone. It also guarantees the default alignment `sizeof(void*)` if has to reserve a new block.

```
byte_t*
bmem_realloc(byte_t *mem,
             const uint32_t size,
             const uint32_t new_size);
```

mem Pointer to the original block to relocate.

size Size in bytes of the original block mem.

new_size New required size, in bytes.

Return:

Pointer to the relocated block. It will be the same as the original pointer `mem` if the relocation “in-situ” has been successful. Must be released with `bmem_free` when it is no longer necessary.

Remarks:

Use “*Heap - Memory manager*” (page 196) for more efficient and secure allocations.

bmem_aligned_malloc

Reserve a memory block with alignment.

```
byte_t*
bmem_aligned_malloc(const uint32_t size,
                  const uint32_t align);
```

size Size in bytes of the block.

align Alignment. It must be power of 2.

Return:

Pointer to the new block. Must be released with `bmem_free` when it is no longer necessary.

Remarks:

Use “*Heap - Memory manager*” (page 196) for more efficient and secure allocations.

bmem_aligned_realloc

Like `bmem_realloc`, but it guarantees a specific alignment.

```
byte_t*
bmem_aligned_realloc(byte_t *mem,
                   const uint32_t size,
                   const uint32_t new_size,
                   const uint32_t align);
```

mem Pointer to the original block to relocate.

size Size in bytes of the original block mem.

new_size New required size, in bytes.

align Alignment. It must be power of 2.

Return:

Pointer to the relocated block.

Remarks:

Use “*Heap - Memory manager*” (page 196) for more efficient and secure allocations.

bmem_free

Free memory pointed by mem, previously reserved by `bmem_malloc`, `bmem_realloc` or its equivalents with alignment.

```
void
bmem_free(byte_t *mem);
```

mem Pointer to the memory block to be released.

Remarks:

Use “*Heap - Memory manager*” (page 196) for more efficient and secure allocations.

bmem_set1

Fill a block of memory with the same 1-byte mask.

```
void
bmem_set1(byte_t *dest,
          const uint32_t size,
          const byte_t mask);
```

dest Pointer to the memory block.

size Size in bytes of the block dest.

mask Mask.

bmem_set4

Fill a block of memory with the same 4-byte mask.

```
void
bmem_set4(byte_t *dest,
          const uint32_t size,
          const byte_t *mask);
```

```
byte_t mblock[10];
byte_t mask[4] = "abcd";
bmem_set4(mblock, 10, mask);
/* mblock = "abcdabcdab" */
```

dest Pointer to the memory block.

size Size in bytes of the block dest. It is not necessary to be a multiple of 4.

mask 4-byte mask.

bmem_set8

Fill a block of memory with the same 8-byte mask.

```
void
bmem_set8(byte_t *dest,
          const uint32_t size,
          const byte_t *mask);
```

dest Pointer to the memory block.

size Size in bytes of the block `dest`. It is not necessary to be a multiple of 8.

mask 8-byte mask.

bmem_set16

Fill a block of memory with the same 16-byte mask.

```
void
bmem_set16(byte_t *dest,
           const uint32_t size,
           const byte_t *mask);
```

dest Pointer to the memory block.

size Size in bytes of the block `dest`. It is not necessary to be a multiple of 16.

mask 16-byte mask.

bmem_set_u32

Fill an array of type `uint32_t` with the same value.

```
void
bmem_set_u32(uint32_t *dest,
            const uint32_t n,
            const uint32_t value);
```

dest Pointer to the array.

n Array size (number of elements).

value Filling value.

bmem_set_r32

Fills an array of type `real32_t` with the same value.

```
void
bmem_set_r32(real32_t *dest,
```

```

    const uint32_t n,
    const real32_t value);

```

- dest Pointer to the array.
- n Array size (number of elements).
- value Filling value.

bmem_cmp

Compare two generic memory blocks.

```

int
bmem_cmp(const byte_t *mem1,
         const byte_t *mem2,
         const uint32_t size);

```

- mem1 Pointer to the first block of memory.
- mem2 Pointer to the second block of memory.
- size Number of bytes to compare.

Return:

Comparison result.

bmem_is_zero

Check if a memory block is completely filled with 0s.

```

bool_t
bmem_is_zero(const byte_t *mem,
            const uint32_t size);

```

- mem Pointer to the memory block.
- size Size in bytes of the block mem.

Return:

TRUE if all positions are 0, otherwise **FALSE**.

bmem_set_zero

Fill a memory block with 0s.

```

void
bmem_set_zero(byte_t *dest,
             const uint32_t size);

```

`dest` Pointer to the memory block that must be filled.

`size` Size in bytes of the block `dest`.

bmem_zero

Initialize an object with 0s.

```
void
bmem_zero(type *dest,
          type);
```

```
typedef struct
```

```
{
    uint32_t f1;
    real32_t f2;
    String *f3;
    ...
} MyType;
```

```
MyType t1;
bmem_zero(&t1, MyType);
/* t1 = {0} */
```

`dest` Pointer to the object.

`type` Object type.

bmem_zero_n

Initialize an array of objects with 0s.

```
void
bmem_zero_n(type *dest,
            const uint32_t n,
            type);
```

`dest` Object array.

`n` Array size.

`type` Object type.

bmem_copy

Copy the contents of one block in another. The blocks must not be overlapping.

```
void
bmem_copy(byte_t *dest,
          const byte_t *src,
```



```
const uint32_t size);
```

dest Pointer to the destination block.

src Pointer to the source block.

size Number of bytes to copy.

bmem_copy_n

Copy an array of objects to another location.

```
void
bmem_copy_n(type *dest,
            const type *src,
            const uint32_t n,
            type);
```

```
real32_t v1[64];
real32_t v2[64]; = {1.f, 45.f, 12.4f, ...};
bmem_copy_n(v1, v2, 64, real32_t);
```

dest Pointer to the destination array.

src Pointer to the source array.

n Array size (number of elements, not bytes).

type Object type.

bmem_move

Like `bmem_copy`, but the blocks can overlap.

```
void
bmem_move(byte_t *dest,
          const byte_t *src,
          const uint32_t size);
```

dest Pointer to the destination block.

src Pointer to the source block.

size Number of bytes to copy.

Remarks:

If we have the certainty that both blocks do not overlap, `bmem_copy` is much more efficient.

bmem_overlaps

Check if two memory blocks overlap.

```
bool_t
bmem_overlaps(byte_t *mem1,
              byte_t *mem2,
              const uint32_t size1,
              const uint32_t size2);
```

- mem1 Pointer to the first block.
- mem2 Pointer to the second block.
- size1 Size of the first block (in bytes).
- size2 Size of the second block (in bytes).

Return:

TRUE if there is overlap.

bmem_rev

Reverts a memory block $m[i] = m[ni-1]$.

```
void
bmem_rev(byte_t *mem,
         const uint32_t size);
```

- mem Pointer to the memory block.
- size Block size in bytes.

bmem_rev2

Reverts a 2-byte memory block.

```
void
bmem_rev2(byte_t *mem);
```

- mem Pointer to the memory block.

bmem_rev4

Reverts a 4-byte memory block.

```
void
bmem_rev4(byte_t *mem);
```

- mem Pointer to the memory block.

bmem_rev8

Reverts an 8-byte memory block.

```
void
bmem_rev8(byte_t *mem);
```

mem Pointer to the memory block.

bmem_revcopy

Make a reverse copy of a memory block.

```
void
bmem_revcopy(byte_t *dest,
              const byte_t *src,
              const uint32_t size);
```

dest Pointer to the destination block.

src Pointer to the source block.

size Number of bytes to copy.

bmem_rev_elems

Reverts the elements inside an array.

```
void
bmem_rev_elems(type*,
               const uint32_t num_elems,
               type);
```

type* Pointer to the beginning of the array.

num_elems Number of elements of the array.

type Object type.

bmem_swap

Exchanges the contents of two memory blocks (not overlapping). At end, mem1[i] = mem2[i] and mem2[i] = mem1[i].

```
void
bmem_swap(byte_t *mem1,
           byte_t *mem2,
           const uint32_t size);
```

mem1 Pointer to the first block.
 mem2 Pointer to the second block.
 size Number of bytes to be exchanged.

bmem_swap_type

Exchange the contents of two objects.

```
void
bmem_swap_type(type *obj1,
               type *obj2,
               type);
```

obj1 First object.
 obj2 Second object.
 type Object type.

bmem_shuffle

Randomly shuffles a memory block.

```
void
bmem_shuffle(byte_t *mem,
             const uint32_t size,
             const uint32_t esize);
```

mem Pointer to the memory block.
 size Block size (number of elements).
 esize Size of each element.

Remarks:

This function is based on a pseudo-random number generator. Use `bmath_rand_seed` to change the sequence.

bmem_shuffle_n

Randomly shuffle an object array.

```
void
bmem_shuffle_n(type *array,
              const uint32_t size,
              type);
```

array Elements array.
size Number of elements.
type Object type.

Remarks:

This function is based on a pseudo-random number generator. Use `bmmath_rand_seed` to change the sequence.

Osbs library

39.1. Types and Constants

enum platform_t

Operating systems supported by NAppGUI.

- `ekWINDOWS` Microsoft Windows.
- `ekMACOS` Apple macOS.
- `ekLINUX` GNU/Linux.
- `ekIOS` Apple iOS.

enum device_t

Device type.

- `ekDESKTOP` Desktop or laptop computer.
- `ekPHONE` Phone.
- `ekTABLET` Tablet.

enum win_t

Microsoft Windows versions.

- `ekWIN_9x` Windows 95, 98 or ME.
- `ekWIN_NT4` Windows NT4.
- `ekWIN_2K` Windows 2000.
- `ekWIN_XP` Windows XP.

<code>ekWIN_XP1</code>	Windows XP Service Pack 1.
<code>ekWIN_XP2</code>	Windows XP Service Pack 2.
<code>ekWIN_XP3</code>	Windows XP Service Pack 3.
<code>ekWIN_VI</code>	Windows Vista.
<code>ekWIN_VI1</code>	Windows Vista Service Pack 1.
<code>ekWIN_VI2</code>	Windows Vista Service Pack 2.
<code>ekWIN_7</code>	Windows 7.
<code>ekWIN_71</code>	Windows 7 Service Pack 1.
<code>ekWIN_8</code>	Windows 8.
<code>ekWIN_81</code>	Windows 8 Service Pack 1.
<code>ekWIN_10</code>	Windows 10.
<code>ekWIN_NO</code>	The system is not Windows.

enum endian_t

Represents the “*Byte order*” (page 213), or how multi-byte data is stored in memory.

<code>ekLITEND</code>	<i>Little endian.</i> The lowest byte first.
<code>ekBIGEND</code>	<i>Big endian.</i> The highest byte first.

enum week_day_t

Weekday.

<code>ekSUNDAY</code>	Sunday.
<code>ekMONDAY</code>	Monday.
<code>ekTUESDAY</code>	Tuesday.
<code>ekWEDNESDAY</code>	Wednesday.
<code>ekTHURSDAY</code>	Thursday.
<code>ekFRIDAY</code>	Friday.
<code>ekSATURDAY</code>	Saturday.

enum month_t

Month.

<code>ekJANUARY</code>	January.
<code>ekFEBRUARY</code>	February.
<code>ekMARCH</code>	March.
<code>ekAPRIL</code>	April.
<code>ekMAY</code>	May.
<code>ekJUNE</code>	June.
<code>ekJULY</code>	July.
<code>ekAUGUST</code>	August.
<code>ekSEPTEMBER</code>	September.
<code>ekOCTOBER</code>	October.
<code>ekNOVEMBER</code>	November.
<code>ekDECEMBER</code>	December.

enum file_type_t

File type.

<code>ekARCHIVE</code>	Ordinary file.
<code>ekDIRECTORY</code>	Directory.
<code>ekOTHERFILE</code>	Another type of file reserved for the operating system (devices, pipes, etc.)

enum file_mode_t

Different ways to open a file.

<code>ekREAD</code>	Read only.
<code>ekWRITE</code>	Read and write.
<code>ekAPPEND</code>	Writing at the end of the file.

enum file_seek_t

Initial position of the pointer in `bfile_seek`.

<code>ekSEEKSET</code>	Start of file.
<code>ekSEEKCUR</code>	Current pointer position.

`ekSEEKEND` End of file.

enum ferror_t

Error codes manipulating files.

`ekFEXISTS` The file already exists.

`ekFNOPATH` The directory does not exist.

`ekFNOfFile` The file does not exist.

`ekFBIGNAME` The name of the file exceeds the capacity of the buffer to store it.

`ekFNOfiles` There are no more files when we travel through a directory.
`bfile_dir_get`.

`ekFNOEMPTY` You are trying to delete a non-empty directory.
`hfile_dir_destroy`.

`ekFNOACCESS` The file can not be accessed (possibly due to lack of permissions).

`ekFLOCK` The file is being used by another process.

`ekFBIG` The file is so big. It may appear in functions that can not handle files larger than 4Gb.

`ekFSEEKNEG` Negative position within a file. See `bfile_seek`.

`ekFUNDEF` There is no more information about the error.

`ekFOK` There is no error.

enum perror_t

Error codes working with processes.

`ekPPIPE` Error in the standard I/O channel.

`ekPEXEC` Error when launching the process. Surely the command is invalid.

`ekPOK` There is no error.

enum serror_t

Error code in network communications.

<code>ekSNONET</code>	There is no Internet connection on the device.
<code>ekSNOHOST</code>	Unable to connect to the remote server.
<code>ekSTIMEOUT</code>	The maximum wait time for the connection has been exceeded.
<code>ekSSTREAM</code>	Error in the I/O channel when reading or writing.
<code>ekSUNDEF</code>	There is no more information about the error.
<code>ekSOK</code>	There is no error.

struct Date

Public structure that contains the fields of a time stamp (date + time) for direct access.

```
struct Date
{
    int16_t year;
    uint8_t month;
    uint8_t wday;
    uint8_t mday;
    uint8_t hour;
    uint8_t minute;
    uint8_t second;
};
```

<code>year</code>	Year.
<code>month</code>	The month (1-12). <code>month_t</code> .
<code>wday</code>	The day of the week (0-6). <code>week_day_t</code> .
<code>mday</code>	The day of the month (1-31).
<code>hour</code>	The hour (0-23).
<code>minute</code>	The minute (0-59).
<code>second</code>	The second (0-59).

struct Dir

Represents an open directory, by which you can browse. `bfile_dir_open`.

```
struct Dir;
```

struct File

File handler on disk. `bfile_open`.

```
struct File;
```

struct Mutex

Mutual exclusion mechanism (**mutex**) used to control concurrent access to a resource. “*Locks*” (page 183).

```
struct Mutex;
```

struct Proc

Represents a running process, with which the main program can communicate using the standard I/O channels. `bproc_exec`.

```
struct Proc;
```

struct DLib

Represents a dynamically loaded library in the process. `dlib_open`.

```
struct DLib;
```

struct Thread

Represents a thread of execution, launched from the main process. `bthread_create`.

```
struct Thread;
```

struct Socket

Handler of network connection. `bsocket_connect`.

```
struct Socket;
```

39.2. Functions

FPtr_thread_main

Prototype of a thread start function (*thread main*). `bthread_create`.

```
uint32_t
(*FPtr_thread_main)(type *data);
```

data Data passed to the thread *main* function.

Return:

The thread return value.

osbs_start

Start *osbs* library, reserving space for global internal structures.

```
void
osbs_start(void);
```

osbs_finish

Ends *osbs* library, freeing space from global internal structures.

```
void
osbs_finish(void);
```

osbs_platform

Get the operating system in which the application is running.

```
platform_t
osbs_platform(void);
```

Return:

The platform.

osbs_windows

Get the Windows version.

```
win_t
osbs_windows(void);
```

Return:

The Microsoft Windows version.

osbs_endian

Get the “Byte order” (page 213) of the running platform.

```
endian_t
osbs_endian(void);
```

Return:

The byte order of multi-byte data types.

bproc_exec

Launch a new process.

```
Proc*
bproc_exec(const char_t *command,
           perror_t *error);
```

command The command to execute (path and arguments). Eg. "ls -lh" or "C:\Programs\imgresize background.png -w640 -h480".

error Error code if the function fails. Can be `NULL`.

Return:

Child process handler that we can use to communicate with him. If the function fails, return `NULL`.

Remarks:

“Multi-processing examples” (page 176).

bproc_close

Close communication with the child process and free resources.

```
void
bproc_close(Proc **proc);
```

proc Process handler. It will be set to `NULL` after closing.

Remarks:

If the process is still running, this function does not finish it. It only closes the communication channel between the parent and child that will continue to run independently. Like any other object, a process must always be closed, even if it has already finished its execution. “Multi-processing examples” (page 176).

bproc_cancel

Force the finalization of the process.

```
bool_t
bproc_cancel(Proc *proc);
```

proc Process handler.

Return:

`TRUE` if the process is finish. `FALSE` otherwise.

bproc_wait

Wait until the child process finishes.

```
uint32_t
bproc_wait(Proc *proc);
```

proc Process handler.

Return:

The return value of the child process or `UINT32_MAX` if there is any error.

bproc_finish

Check if the child process is still running.

```
bool_t
bproc_finish(Proc *proc,
             uint32_t *code);
```

proc Process handler.

code The output value of the process (if it has finished). Can be `NULL`.

Return:

`TRUE` if the child process has finish, `FALSE` if not.

Remarks:

This function returns immediately. It does not block the process that calls it.

bproc_read

Read data from the process standard output (stdout).

```
bool_t
bproc_read(Proc *proc,
           byte_t *data,
           const uint32_t size,
           uint32_t *rsize,
           perror_t *error);
```

- proc Process handler.
- data Buffer where the read data will be written.
- size The maximum bytes to read (buffer size).
- rsize Receive the number of bytes actually read. Can be `NULL`.
- error Error code if the function fails. Can be `NULL`.

Return:

`TRUE` if data has been read. `FALSE` if any error has occurred.

Remarks:

This function will block the parent process until the child writes in its `stdout`. If there is no data in the channel and the child ends, will return `FALSE` with `rsize = 0` and `error = ekPROC_SUCCESS`. “*Multi-processing examples*” (page 176).

bproc_eread

Read data from the process error output (`stderr`).

```
bool_t
bproc_eread(Proc *proc,
            byte_t *data,
            const uint32_t size,
            uint32_t *rsize,
            perror_t *error);
```

- proc Process handler.
- data Buffer where the read data will be written.
- size The maximum bytes to read (buffer size).
- rsize Receive the number of bytes actually read. Can be `NULL`.
- error Error code if the function fails. Can be `NULL`.

Return:

`TRUE` if data has been read. `FALSE` if any error has occurred.

Remarks:

This function will block the parent process until the child writes in its `stdout`. If there is no data in the channel and the child ends, will return `FALSE` with `rsize = 0` and `error = ekPROC_SUCCESS`. “*Multi-processing examples*” (page 176).

bproc_write

Write data in the process input channel (`stdin`).

```
bool_t
bproc_write(Proc *proc,
            const byte_t *data,
            const uint32_t size,
            uint32_t *wsize,
            perror_t *error);
```

`proc` Process handler.

`data` Buffer that contains the data to write.

`size` The number of bytes to write.

`wsize` It receives the number of bytes actually written. Can be `NULL`.

`error` Error code if the function fails. Can be `NULL`.

Return:

`TRUE` if data has been written. `FALSE` if any error has occurred.

Remarks:

This function will block the parent process if there is no space in the buffer to complete the write. When the child process reads `stdin` and free space, the writing will be completed and the parent process will continue its execution. “*Multi-processing examples*” (page 176).

bproc_read_close

Close the `stdout` channel of child process.

```
bool_t
bproc_read_close(Proc *proc);
```

`proc` Process handler.

Return:

`TRUE` if the channel has been closed. `FALSE` if it was already closed.

Remarks:

This function allows ignoring the output of the child process, preventing blockages due to channel saturation. “*Launching processes*” (page 175).

bproc_eread_close

Close the `stderr` channel of child process.

```
bool_t
bproc_eread_close(Proc *proc);
```

`proc` Process handler.

Return:

`TRUE` if the channel has been closed. `FALSE` if it was already closed.

Remarks:

This function allows ignoring the error output of the child process, preventing blockages due to channel saturation. “*Launching processes*” (page 175).

bproc_write_close

Close the `stdin` channel of child process.

```
bool_t
bproc_write_close(Proc *proc);
```

`proc` Process handler.

Return:

`TRUE` if the channel has been closed. `FALSE` if it was already closed.

Remarks:

Some processes need to read all the `stdin` content before starting work. When closing the channel, the child process receives the signal EOF *End-Of-File* in `stdin`. “*Launching processes*” (page 175).

bproc_exit

End the current process (the caller) and all its execution children.

```
void
bproc_exit(const uint32_t code);
```

`code` The exit code of the process.

bthread_create

Create a new execution thread, which starts in `thmain`.

```
Thread*
bthread_create(FPtr_thread_main thmain,
               type *data,
               type);
```

`thmain` The thread start function *thread_main*. Shared data can be passed through the *data* pointer.

`data` Data passed as a parameter to `thmain`.

`type` Type of *data*.

Return:

Thread handle. If the function fails, return `NULL`.

Remarks:

The thread will run in parallel until `thmain` return or call `bthread_cancel`. “*Throwing threads*” (page 179).

bthread_current_id

Returns the identifier of the current thread, that is, the one that is running when this function is called.

```
int
bthread_current_id(void);
```

Return:

Thread identifier.

bthread_close

Close the thread handler and free resources.

```
void
bthread_close(Thread **thread);
```

`thread` Thread handle. It will be put to `NULL` after closing.

Remarks:

If the thread is still running, this function does not finish it. Like any other object, a thread must always be closed, even if it has already finished its execution. “*Throwing threads*” (page 179).

bthread_cancel

Force a thread termination.

```
void
bthread_cancel(Thread *thread);
```

thread Thread handler.

Remarks:

It is not recommended to call this function. There will be no “clean” exit of the thread. If it is within a critical section, it will not be released. Neither will it release the dynamic memory reserved privately by the thread. The correct way to end a thread of execution is to return `thmain`. Shared variables can be used (“*Mutual exclusion*” (page 183)) to indicate to a thread that it should end cleanly.

bthread_wait

Stops the thread that calls this function until `thread` finishes its execution.

```
uint32_t
bthread_wait(Thread *thread);
```

thread Thread handle to which we must wait.

Return:

The thread return value. If an error occurs, return `UINT32_MAX`.

bthread_finish

Check if the thread is still running.

```
bool_t
bthread_finish(Thread *thread,
               uint32_t *code);
```

thread Thread handler.

code The return value of the *thmain* function (if it has ended). Can be `NULL`.

Return:

`TRUE` if the thread has finished, `FALSE` otherwise.

Remarks:

This function returns immediately.

bthread_sleep

Suspends the execution of the current thread (the one that calls this function) for a certain number of milliseconds.

```
void
bthread_sleep(const uint32_t milliseconds);
```

milliseconds Time interval (in milliseconds) that the suspension will last.

Remarks:

Performs a “passive” suspension, where no “empty loop” will be executed. The thread is dropped by the *scheduler* and reactivated later.

bmutex_create

Creates a mutual exclusion object that allows multiple threads to share the same resource, such as a memory or file area on disk, preventing them from accessing at the same time.

```
Mutex*
bmutex_create(void);
```

Return:

The mutual exclusion handler.

Remarks:

“*Threads*” (page 178), “*Multi-thread example*” (page 180).

bmutex_close

Close the mutual exclusion object and free memory.

```
void
bmutex_close(Mutex **mutex);
```

mutex The mutual exclusion handler. It will be set to `NULL` after closing.

Remarks:

“*Threads*” (page 178), “*Multi-thread example*” (page 180).

bmutex_lock

Marks the start of a critical section, blocking access to a shared resource. If another thread tries to block, it will be stopped until the current thread calls `bmutex_unlock`.

```
void
bmutex_lock(Mutex *mutex);
```

mutex The mutual exclusion handler.

Remarks:

“Threads” (page 178), “Multi-thread example” (page 180).

bmutex_unlock

Mark the end of a critical section, unlocking access to a shared resource. If another thread is waiting, access will be allowed to its critical section and, therefore, to the shared resource.

```
void
bmutex_unlock(Mutex *mutex);
```

mutex The mutual exclusion handler.

Remarks:

To avoid unnecessary delays, the time between `bmutex_lock` and `bmutex_unlock` should be as short as possible. Any calculation that the thread can make in its private memory space must precede the call to `bmutex_lock`. “Threads” (page 178), “Multi-thread example” (page 180).

dlib_open

Load a dynamic library at runtime.

```
DLib*
dlib_open(const char_t *path,
          const char_t *libname);
```

```
DLib *lib = dlib_open(NULL, "myplugin");
// myplugin.dll           In Windows
// libmyplugin.so        In Linux
// libmyplugin.dylib     In macOS
```

path Directory where the library is located. Can be `NULL`.

libname Library name. It must be the “plain” name without prefixes, suffixes or extensions specific to each operating system.

Return:

Pointer to library or `NULL` if failed to load.

Remarks:

If `path` is `NULL`, the library search strategy of each operating system will be followed. See “*Library search paths*” (page 184).

dlib_close

Close a previously opened library with `dlib_open`.

```
void
dlib_close(DLib **dlib);
```

`dlib` Pointer to the library. Will be set to `NULL` upon destruction.

dlib_proc

Get a pointer to a library method.

```
type
dlib_proc(DLib *lib,
          const char_t *procname,
          type);
```

```
typedef uint32_t(*FPtr_add)(const uint32_t, const uint32_t);
FPtr_add func_add = dlib_proc(lib, "plugin_add", FPtr_add);
uint32_t ret = func_add(67, 44);
```

`lib` Library.

`procname` Method name.

`type` Method type. Needed to convert from a generic pointer.

Return:

Pointer to method.

dlib_var

Get a pointer to a library variable.

```
type*
dlib_var(DLib *lib,
         const char_t *varname,
         type);
```

```
const V2Df *vzero = dlib_var(lib, "kV2D_ZEROf", V2Df);
```

lib Library.
varname Variable name.
type Variable type.

Return:

Pointer to variable.

bfile_dir_work

Gets the current working directory of the process. It is the directory from which the relative *pathnames* will be interpreted.

```
uint32_t
bfile_dir_work(char_t *pathname,
               const uint32_t size);
```

pathname Buffer where the directory will be written.
size Size in bytes of the buffer pathname.

Return:

The number of bytes written in pathname, including the null character '\0'.

Remarks:

“*Filename and pathname*” (page 186)

bfile_dir_set_work

Change the current working directory of the application. The relative *pathnames* will be interpreted from here.

```
bool_t
bfile_dir_set_work(const char_t *pathname,
                  ferrort_t *error);
```

pathname The name of the directory.
error Error code if the function fails. Can be **NULL**.

Return:

TRUE if the working directory has changed, **FALSE** if there have been any errors.

Remarks:

“*Filename and pathname*” (page 186)

bfile_dir_home

Get the home directory of the current user.

```
uint32_t
bfile_dir_home(char_t *pathname,
               const uint32_t size);
```

pathname Buffer where the directory will be written.

size Size in bytes of the buffer pathname.

Return:

The number of bytes written in `pathname`, including the null character `'\0'`.

Remarks:

“*Filename and pathname*” (page 186)

bfile_dir_data

Gets the *AppData* directory where application configuration data can be saved.

```
uint32_t
bfile_dir_data(char_t *pathname,
               const uint32_t size);
```

pathname Buffer where the directory will be written.

size Size in bytes of the buffer `pathname`.

Return:

The number of bytes written in `pathname`, including the null character `'\0'`.

Remarks:

“*Home and AppData*” (page 187)

bfile_dir_exec

Gets the absolute *pathname* of the current executable.

```
uint32_t
bfile_dir_exec(char_t *pathname,
               const uint32_t size);
```

```
char_t path[512];
bfile_dir_exec(path, 512);
path = "C:\Program Files\TheApp\theapp.exe"
```

pathname Buffer where the directory will be written.
 size Size in bytes of the buffer pathname.

Return:

The number of bytes written in `pathname`, including the null character `'\0'`.

bfile_dir_create

Create a new directory. It will fail if any intermediate directory of `pathname` does not exist.

```
bool_t
bfile_dir_create(const char_t *pathname,
                 ferror_t *error);
```

pathname Name of the directory to be created, ending in a null character `'\0'`.
 error Error code if the function fails. Can be `NULL`.

Return:

`TRUE` if the directory has been created, `FALSE` if there have been any errors.

Remarks:

`bfile_dir_create` create all intermediate directories at once.

bfile_dir_open

Open a directory to browse its contents. Then you have to use `bfile_dir_get` to iterate. The *filename* is not ordered under any criteria. At the end, you should call `bfile_dir_close`.

```
Dir*
bfile_dir_open(const char_t *pathname,
               ferror_t *error);
```

pathname Name of the directory, ending in a null character `'\0'`.
 error Error code if the function fails. Can be `NULL`.

Return:

The directory handler or `NULL` if there has been an error.

bfile_dir_close

Close a previously open directory with `bfile_dir_open`.

```
void
bfile_dir_close(Dir **dir);
```

`dir` The directory handler. It will be set to `NULL` after the closing.

bfile_dir_get

Gets the attributes of the current file when we go through a directory. Previously we have to open the directory with `bfile_dir_open`.

```
bool_t
bfile_dir_get(Dir *dir,
              char_t *filename,
              const uint32_t size,
              file_type_t *type,
              uint64_t *fsize,
              Date *updated,
              ferror_t *error);
```

`dir` Open directory handler.

`filename` Here will write the name of the file or sub-directory, ending in a null character `'\0'` and without including any path. Can be `NULL`.

`size` Size in bytes of the name buffer.

`type` Get the file type. Can be `NULL`.

`fsize` Gets the file size in bytes. Can be `NULL`.

`updated` Gets the date of the last update of the file. Can be `NULL`.

`error` Error code if the function fails. Can be `NULL`.

Return:

`TRUE` if the file attributes have been read correctly. When there are no more files to go, it returns `FALSE` with `error=ekFNOFILES`.

Remarks:

This function will advance to the next file within the open directory after obtaining the current item's data. If there is not enough space in `name`, will return `FALSE` with `error=ekFBIGNAME` and will not advance to the next file. Use `hfile_dir_loop` to browse the contents of a directory more comfortably.

bfile_dir_delete

Delete a directory. It will fail if the directory is not completely empty. Use `hfile_dir_destroy` to completely and recursively erase a directory that may have content.

```
bool_t
bfile_dir_delete(const char_t *pathname,
                ferror_t *error);
```

`pathname` Name of the directory, ending in a null character `'\0'`.
`error` Error code if the function fails. Can be `NULL`.

Return:

`TRUE` if the directory has been deleted, `FALSE` otherwise.

bfile_create

Create a new file. If previously it already exists its content will be erased. The new file will be opened for writing.

```
File*
bfile_create(const char_t *pathname,
            ferror_t *error);
```

`pathname` File name including its absolute or relative path.
`error` Error code if the function fails. Can be `NULL`.

Return:

The file handler or `NULL` if there has been an error.

bfile_open

Open an existing file. Do not create it, if file does not exist this function will fail.

```
File*
bfile_open(const char_t *pathname,
           const file_mode_t mode,
           ferror_t *error);
```

`pathname` File name including its absolute or relative path.
`mode` Opening mode.
`error` Error code if the function fails. Can be `NULL`.

Return:

The file handler or `NULL` if there has been an error.

bfile_close

Close a file previously opened with `bfile_create` or `bfile_open`.

```
void
bfile_close(File **file);
```

`file` File handler. It will be set to `NULL` after closing.

bfile_lstat

Get the attributes of a file through its *pathname*.

```
bool_t
bfile_lstat(const char_t *pathname,
            file_type_t *type,
            uint64_t *fsize,
            Date *updated,
            ferror_t *error);
```

`pathname` File name including its absolute or relative path.

`type` Get the file type. Can be `NULL`.

`fsize` Gets the file size in bytes. Can be `NULL`.

`updated` Gets the date of the last update of the file. Can be `NULL`.

`error` Error code if the function fails. Can be `NULL`.

Return:

`TRUE` if it worked correctly, or `FALSE` otherwise.

bfile_fstat

Get the attributes of a file through its handler.

```
bool_t
bfile_fstat(File *file,
            file_type_t *type,
            uint64_t *fsize,
            Date *updated,
            ferror_t *error);
```

- file File manager.
- type Get the file type. Can be `NULL`.
- fsize Gets the file size in bytes. Can be `NULL`.
- updated Gets the date of the last update of the file. Can be `NULL`.
- error Error code if the function fails. Can be `NULL`.

Return:

`TRUE` if it worked correctly, or `FALSE` otherwise.

bfile_read

Read data from an open file.

```
bool_t
bfile_read(File *file,
           byte_t *data,
           const uint32_t size,
           uint32_t *rsize,
           ferror_t *error);
```

- file File handler.
- data Buffer where the read data will be written.
- size The number of maximum bytes to read.
- rsize Receive the number of bytes actually read. Can be `NULL`.
- error Error code if the function fails. Can be `NULL`.

Return:

`TRUE` if the data has been read correctly. If there is no more data (end of the file) it returns `FALSE` with `rsize = 0` and `error=eKFOK`.

Remarks:

“*File stream*” (page 202) implements high-level functions for reading/writing files.

bfile_write

Write data in an open file.

```
bool_t
bfile_write(File *file,
           const byte_t *data,
           const uint32_t size,
```

```
uint32_t *wsize,
ferror_t *error);
```

- file File handler.
- data Buffer that contains the data to write.
- size The number of bytes to write.
- wsize It receives the number of bytes actually written. Can be `NULL`.
- error Error code if the function fails. Can be `NULL`.

Return:

`TRUE` if the data has been written, or `FALSE` if there have been any errors.

Remarks:

“*File stream*” (page 202) implements high-level functions for reading/writing files.

bfile_seek

Move a file pointer to a new location.

```
bool_t
bfile_seek(File *file,
           const int64_t offset,
           const file_seek_t whence,
           ferror_t *error);
```

- file File handler.
- offset Number of bytes to move the pointer. Can be negative.
- whence Pointer position from which `offset` will be added.
- error Error code if the function fails. Can be `NULL`.

Return:

`TRUE` if it worked correctly, `FALSE` if not.

Remarks:

It will return `FALSE` and error `ekFSEEKNEG` if the final pointer position is negative. It is not an error to set a pointer to a position beyond the end of the file. The file size does not increase until it is written to. A write operation increases the size of the file to the pointer position plus the size of the write buffer. Intermediate bytes would be left undetermined.

bfile_pos

Return the current position of the file pointer.

```
uint64_t
bfile_pos(const File *file);
```

file File handler.

Return:

Position from start of file.

bfile_delete

Delete a file from the file system.

```
bool_t
bfile_delete(const char_t *pathname,
            ferror_t *error);
```

pathname File name including its absolute or relative path.

error Error code if the function fails. Can be `NULL`.

Return:

`TRUE` if the file has been deleted, or `FALSE` if any error has occurred.

bsocket_connect

Create a client socket and try to establish a connection to a remote server.

```
Socket*
bsocket_connect(const uint32_t ip,
               const uint16_t port,
               const uint32_t timeout_ms,
               serror_t *error);
```

ip The 32-bit IPv4 address of the remote host. `bsocket_str_ip`.

port The connection port.

timeout_ms Maximum number of milliseconds to wait to establish connection. If it is 0 it will wait indefinitely.

error Error code if the function fails. Can be `NULL`.

Return:

Socket handle, or `NULL` if the function fails.

Remarks:

The process will be blocked until a response is obtained from the server or the timeout is fulfilled. See “*Client/Server example*” (page 188).

bsocket_server

Create a server socket.

```
Socket*
bsocket_server(const uint16_t port,
               const uint32_t max_connect,
               error_t *error);
```

port The port where the server will “listen”.

max_connect The maximum number of connections can queue.

error Error code if the function fails. It can be `NULL`.

Return:

Socket handle, or `NULL` if the function fails.

Remarks:

Client requests will be stored in a queue until a call to `bsocket_accept` is received. See “*Client/Server example*” (page 188).

bsocket_accept

Accepts a connection to the server created with `bsocket_server` and starts the conversation with the client.

```
Socket*
bsocket_accept(Socket *socket,
               const uint32_t timeout_ms,
               error_t *error);
```

socket Handler returned by `bsocket_server`.

timeout_ms Maximum number of milliseconds to wait to receive the request. If it is 0 it will wait indefinitely.

error Error code if the function fails. It can be `NULL`.

Return:

Socket handle, or `NULL` if the function fails.

Remarks:

The process will be blocked until a request is obtained from a client or the timeout is fulfilled. See “*Client/Server example*” (page 188).

bsocket_close

Close a previously created socket with `bsocket_connect`, `bsocket_server` or `bsocket_accept`.

```
void
bsocket_close(Socket **socket);
```

socket The socket handler. It will be set to `NULL` after closing.

bsocket_local_ip

Get the local ip address and port associated with the socket.

```
void
bsocket_local_ip(Socket *socket,
                 uint32_t *ip,
                 uint16_t *port);
```

socket Socket handle.

ip Local IP address.

port Local IP port.

bsocket_remote_ip

Get the IP address and the remote port associated with the other interlocutor of the connection.

```
void
bsocket_remote_ip(Socket *socket,
                  uint32_t *ip,
                  uint16_t *port);
```

socket Socket handle.

ip Remote IP address.

port Remote IP port.

bsocket_read_timeout

Sets the maximum time to wait for the function `bsocket_read`.

```
void
bsocket_read_timeout(Socket *socket,
                    const uint32_t timeout_ms);
```

socket Socket handle.

timeout_ms Maximum number of milliseconds to wait for the caller to write data to the channel. If it is 0 it will wait indefinitely.

bsocket_write_timeout

Sets the maximum time to wait for the function `bsocket_write`.

```
void
bsocket_write_timeout(Socket *socket,
                    const uint32_t timeout_ms);
```

socket Socket handle.

timeout_ms Maximum number of milliseconds that will wait until the caller reads the data and unblocked on the channel. If it is 0 it will wait indefinitely.

bsocket_read

Read data from the socket.

```
bool_t
bsocket_read(Socket *socket,
            byte_t *data,
            const uint32_t size,
            uint32_t *rsize,
            error_t *error);
```

socket Socket handle.

data Buffer where the read data will be written.

size The number of maximum bytes to read (buffer size).

rsize Receive the number of bytes actually read. Can be `NULL`.

error Error code if the function fails. Can be `NULL`.

Return:

`TRUE` if data has been read. `FALSE` if any error has occurred.

Remarks:

The process will be blocked until the interlocutor writes data to the channel or the timeout expires. See `bsocket_read_timeout`.

bsocket_write

Write data in the socket.

```
bool_t
bsocket_write(Socket *socket,
              const byte_t *data,
              const uint32_t size,
              uint32_t *wsize,
              serror_t *error);
```

socket Socket handle.

data Buffer that contains the data to write.

size The number of bytes to write.

wsize It receives the number of bytes actually written. Can be `NULL`.

error Error code if the function fails. Can be `NULL`.

Return:

`TRUE` if data has been written. `FALSE` if any error has occurred.

Remarks:

The process will be blocked if the channel is full until the interlocutor reads the data and unblocks or expires the timeout. See `bsocket_write_timeout`.

bsocket_url_ip

Get the IPv4 address of a host from its url.

```
uint32_t
bsocket_url_ip(const char_t *url,
              serror_t *error);
```

```
uint32_t ip = bsocket_url_ip("www.google.com", NULL);
if (ip != 0)
{
    Socket *sock = bsocket_connect(ip, 80, NULL);
    ...
}
```

- url The host url, eg. `www.google.com`.
- error Error code if the function fails. Can be `NULL`.

Return:

Value of the host's IPv4 address or 0 if there has been an error.

bsocket_str_ip

Get the IPv4 address from a string of type "192.168.1.1".

```
uint32_t
bsocket_str_ip(const char_t *ip);

uint32_t ip = bsocket_str_ip("192.168.1.1");
Socket *sock = bsocket_connect(ip, 80, NULL);
...
}
```

- ip The string with the IP.

Return:

Value of the IPv4 address in 32-bit binary format.

bsocket_host_name

Gets the name of the host.

```
const char_t*
bsocket_host_name(char_t *buffer,
                 const uint32_t size);
```

- buffer Buffer to store the name.

- size Size of buffer.

Return:

Pointer to the string buffer.

bsocket_host_name_ip

Gets the host name from its IP.

```
const char_t*
bsocket_host_name_ip(uint32_t ip,
                    char_t *buffer,
                    const uint32_t size);
```

- ip Value of the IPv4 address in 32-bit binary format.
- buffer Buffer to store the name.
- size Size of buffer.

Return:

Pointer to the string buffer.

bsocket_ip_str

Gets the IP address in text string format.

```
const char_t*
bsocket_ip_str(uint32_t ip,
               const char_t *ip);
```

- ip Value of the IPv4 address in 32-bit binary format.
- ip The string with the IP.

Return:

String of type “192.168.1.1”.

Remarks:

The string is returned in an internal buffer that will be overwritten on the next call. Make a copy of the string if we need it to be persistent.

bsocket_hton2

Change the “endianness” of a 16bit value prior to being sent through the socket *Host-to-Network*.

```
void
bsocket_hton2(byte_t *dest,
               const byte_t *src);
```

```
uint16_t value = 45321;
byte_t dest[2];
bsocket_hton2(dest, (const byte_t*)&value);
bsocket_write(sock, dest, 2, NULL, NULL);
```

- dest Destination buffer (at least 2 bytes).
- src Buffer (variable).

bsocket_hton4

Same as `bsocket_hton2`, for 4-byte values.

```
void
bsocket_hton4(byte_t *dest,
              const byte_t *src);
```

dest Destination buffer (at least 4 bytes).

src Buffer (variable).

bsocket_hton8

Same as `bsocket_hton2`, for 8-byte values.

```
void
bsocket_hton8(byte_t *dest,
              const byte_t *src);
```

dest Destination buffer (at least 8 bytes).

src Buffer (variable).

bsocket_ntoh2

Change the “endianness” of a 16bit value after being received by the socket *Network-to-Host*.

```
void
bsocket_ntoh2(byte_t *dest,
              const byte_t *src);
```

```
byte_t src[2];
uint16_t value;
bsocket_read(sock, src, 2, NULL, NULL);
bsocket_ntoh2((byte_t*)&value, src);
// value = 45321
```

dest 16-bit destination buffer (variable).

src Buffer received by socket.

bsocket_ntoh4

Same as `bsocket_ntoh2`, for 4-byte values.

```
void
bsocket_ntoh4(byte_t *dest,
              const byte_t *src);
```

dest Buffer (variable) destination 32bits.

src Buffer received by socket.

bsocket_ntoh8

Same as `bsocket_ntoh2`, for 8-byte values.

```
void
bsocket_ntoh8(byte_t *dest,
              const byte_t *src);
```

dest Buffer (variable) destination 64bits.

src Buffer received by socket.

btime_now

Gets the number of micro-seconds elapsed since January 1, 1970 until this precise moment. Use the difference between instants to know the time consumed by a process.

```
uint64_t
btime_now(void);
```

Return:

The number of micro-seconds elapsed, that is, the number of intervals of 1/1000000 seconds.

Remarks:

The initial instant is January 1, 1970 in Unix/Linux systems and January 1, 1601 in Windows since it is the first year of the Gregorian cycle in which Windows NT was activated. This function equates both starts, always returning the Unix time.

btime_date

Gets the current system date.

```
void
btime_date(Date *date);
```

date Current date.

btime_to_micro

Convert a date to Unix Time.

```
uint64_t
btime_to_micro(const Date *date);
```

date The date to convert.

Return:

The number of micro-seconds since January 1, 1970 UTC.

btime_to_date

Transform Unix Time into a date.

```
void
btime_to_date(const uint64_t micro,
              Date *date);
```

micro Number of micro-seconds since January 1, 1970 UTC.

date Result date.

log_printf

Write a message in the *log*, with the printf format.

```
uint32_t
log_printf(const char_t *format,
           ...);
```

```
log_printf("Leaks of object '%s' (%d bytes)", object->name, object->size);
[12:34:23] Leaks of object 'String' (96 bytes)
```

format String with the printf-like format with a variable number of parameters.

... Arguments or variables of printf.

Return:

The number of bytes written.

log_output

It establishes whether the content of the *log* will be redirected or not to the standard output.

```
void
log_output(const bool_t std,
           const bool_t err);
```

- std If **TRUE** the lines will be sent to the standard output `stdout`. Default, **TRUE**.
- err If **TRUE** the lines will be sent to the error output `stderr`. Default, **FALSE**.

log_file

Set a destination file, where the *log* lines will be written.

```
void
log_file(const char_t *pathname);
```

- pathname File name including its absolute or relative path. If the file does not exist it will be created and if it already exists, future lines will be added at the end of it. If **NULL** writing to *log* file will be disabled.

log_get_file

Gets the current file associated with the *log*.

```
const char_t*
log_get_file(void);
```

Return:

The absolute *pathname* of the file.

Core library

40.1. Types and Constants

DeclSt

Given a struct, enable macros for compile-time type checking in “*Arrays*” (page 215) and “*Binary search trees*” (page 225). Usage: `DeclSt(Product)` immediately after the struct definition. See “*Registers or pointers*” (page 216).

DeclPt

Same as `DeclSt` for pointer containers.

kSTDIN

Stream connected to the standard input `stdin`.

```
Stream* kSTDIN;
```

kSTDOUT

Stream connected to standard output `stdout`.

```
Stream* kSTDOUT;
```

kSTDERR

Stream connected to error output `stderr`.

```
Stream* kSTDERR;
```

kDEVNULL

Null write stream. All content sent through this channel will be ignored.

```
Stream* kDEVNULL;
```

kDATE_NULL

Represents an invalid date.

```
Date kDATE_NULL;
```

enum core_event_t

Event types in *core* library.

- `ekEASSERT` Redirection of “*Asserts*” (page 159).
- `ekEFILE` A file detected while browsing a directory. `hfile_dir_loop`.
- `ekEENTRY` Entry in a sub-directory while we go through a directory. `hfile_dir_loop`.
- `ekEEXIT` Exit of a sub-directory.

enum sstate_t

“*Streams*” (page 201) state.

- `ekSTOK` All ok, no errors.
- `ekSTEND` No more data on the channel.
- `ekSTCORRUPT` The data in the channel is invalid or has not been read correctly.
- `ekSTBROKEN` Error in the communication channel.

enum vkey_t

Keyboard codes. See “*Using the keyboard*” (page 332).

- `ekKEY_UNDEF`
- `ekKEY_A`
- `ekKEY_S`

ekKEY_D
ekKEY_F
ekKEY_H
ekKEY_G
ekKEY_Z
ekKEY_X
ekKEY_C
ekKEY_V
ekKEY_BSLASH
ekKEY_B
ekKEY_Q
ekKEY_W
ekKEY_E
ekKEY_R
ekKEY_Y
ekKEY_T
ekKEY_1
ekKEY_2
ekKEY_3
ekKEY_4
ekKEY_6
ekKEY_5
ekKEY_9
ekKEY_7
ekKEY_8
ekKEY_0
ekKEY_RCURLY
ekKEY_O

```
    ekKEY_U
ekKEY_LCURLY
    ekKEY_I
    ekKEY_P
ekKEY_RETURN
    ekKEY_L
    ekKEY_J
ekKEY_SEMICOLON
    ekKEY_K
    ekKEY_QUEST
    ekKEY_COMMA
    ekKEY_MINUS
    ekKEY_N
    ekKEY_M
ekKEY_PERIOD
    ekKEY_TAB
    ekKEY_SPACE
    ekKEY_GTLT
    ekKEY_BACK
ekKEY_ESCAPE
    ekKEY_F17
ekKEY_NUMDECIMAL
    ekKEY_NUMMULT
    ekKEY_NUMADD
ekKEY_NUMLOCK
    ekKEY_NUMDIV
    ekKEY_NUMRET
ekKEY_NUMMINUS
```

```
    ekKEY_F18
    ekKEY_F19
ekKEY_NUMEQUAL
    ekKEY_NUM0
    ekKEY_NUM1
    ekKEY_NUM2
    ekKEY_NUM3
    ekKEY_NUM4
    ekKEY_NUM5
    ekKEY_NUM6
    ekKEY_NUM7
    ekKEY_NUM8
    ekKEY_NUM9
    ekKEY_F5
    ekKEY_F6
    ekKEY_F7
    ekKEY_F3
    ekKEY_F8
    ekKEY_F9
    ekKEY_F11
    ekKEY_F13
    ekKEY_F16
    ekKEY_F14
    ekKEY_F10
    ekKEY_F12
    ekKEY_F15
ekKEY_PAGEUP
    ekKEY_HOME
```

```
    ekKEY_SUPR
    ekKEY_F4
ekKEY_PAGEDOWN
    ekKEY_F2
    ekKEY_END
    ekKEY_F1
    ekKEY_LEFT
ekKEY_RIGHT
    ekKEY_DOWN
    ekKEY_UP
ekKEY_LSHIFT
ekKEY_RSHIFT
    ekKEY_LCTRL
    ekKEY_RCTRL
    ekKEY_LALT
    ekKEY_RALT
ekKEY_INSERT
ekKEY_EXCLAM
    ekKEY_MENU
    ekKEY_LWIN
    ekKEY_RWIN
    ekKEY_CAPS
ekKEY_TILDE
ekKEY_GRAVE
    ekKEY_PLUS
```

enum mkey_t

Modifier keys.

```
    ekMKEY_NONE
```

```

    ekMKEY_SHIFT
ekMKEY_CONTROL
    ekMKEY_ALT
ekMKEY_COMMAND

```

enum token_t

Token types on `stm_read_token`.

```

    ekTSLCOM  One-line comment, which begins with //.
    ekTMLCOM  Multi-line commentary, enclosed between /* and */.
    ekTSPACE  Represents a series of blanks (' ', '\t', '\v', '\f', '\r').
    ekTEOL    Represents the new line character ('\n').
    ekTLESS   Less than sign '<'.
    ekTGREAT  Greater than sign '>'.
    ekTCOMMA  Comma sign ','.
    ekTPERIOD Point sign '.'.
    ekTSCOLON Semicolon sign ';'.
    ekTCOLON  Colon sign ':'.
    ekTOPENPAR Opening parenthesis '('.
    ekTCLOSPAR Closing parenthesis ')'.
    ekTOPENBRAC Opening bracket '['.
    ekTCLOSBRAC Closing bracket ']'.
    ekTOPENCURL Opening curly bracket '{'.
    ekTCLOSCURL Closing curly bracket '}'.
    ekTPLUS   Plus sign '+'.
    ekTMINUS  Minus sign '-'.
    ekTASTERK Asterisk sign '*'.
    ekTEQUALS Equal sign '='.
    ekTDOLLAR Dollar sign.
    ekTPERCEN Percentage sign '%'.

```

<code>ekTPOUND</code>	Pound sign '# '.
<code>ekTAMPER</code>	Ampersand sign '& '.
<code>ekTAPOST</code>	Apostrophe sign '''.
<code>ekTQUOTE</code>	Quotation sign '" '.
<code>ekTCIRCUM</code>	Circumflex accent sign '^ '.
<code>ekTTILDE</code>	Tilde sign '~ '.
<code>ekTEXCLA</code>	Exclamation sign '! '.
<code>ekTQUEST</code>	Question mark '? '.
<code>ekTVLINE</code>	Vertical bar sign ' '.
<code>ekTSLASH</code>	Slash bar sign '/ '.
<code>ekTBSLASH</code>	Backslash sign '\ '.
<code>ekTAT</code>	At sign '@ '.
<code>ekTINTEGER</code>	Integer number. “Numbers” (page 210).
<code>ekTOCTAL</code>	Octal number. “Numbers” (page 210).
<code>ekTHEX</code>	Hexadecimal number. “Numbers” (page 210).
<code>ekTREAL</code>	Real number. “Numbers” (page 210).
<code>ekTSTRING</code>	Unicode character string, enclosed in quotation marks. “Strings” (page 209).
<code>ekTIDENT</code>	Identifier. “Identifiers” (page 208).
<code>ekTUNDEF</code>	Unknown token.
<code>ekTCORRUP</code>	Error in the input “Streams” (page 201) or data.
<code>ekTEOF</code>	End of the “Streams” (page 201) or data. No more tokens.
<code>ekTRESERVED</code>	Keywords. Being of general purpose, the analyzer does not label any identifier as a reserved word. It must be done in phases after the analysis.

struct Buffer

Block of memory of general purpose, reserved dynamically. Once created, you can no longer resize. “Buffers” (page 200).

```
struct Buffer;
```

struct String

UTF8 character string reserved dynamically. They are “partially mutable” objects. The reserved memory can not grow, but characters can be substituted as long as the buffer’s initial capacity does not overflow. “*Strings*” (page 200).

```
struct String;
```

struct Stream

Generic input/output channel, where it is possible to read and write formatted data. “*Streams*” (page 201).

```
struct Stream;
```

struct ArrSt

Array of records. The type of object is indicated in parentheses. “*Arrays*” (page 215).

```
struct ArrSt;
```

struct ArrPt

Pointers array. The type of object is indicated in parentheses. “*Arrays (pointers)*” (page 225).

```
struct ArrPt;
```

struct SetSt

Set of records. The type of object is indicated in parentheses. “*Binary search trees*” (page 225).

```
struct SetSt;
```

struct SetPt

Pointers set. The type of object is indicated in parentheses. “*Binary search trees (pointers)*” (page 230).

```
struct SetPt;
```

struct RegEx

Regular expression. “*Regular expressions*” (page 230).

```
struct RegEx;
```

struct Event

Contains information regarding an event. “*Events*” (page 237).

```
struct Event;
```

struct KeyBuf

Keyboard buffer with the state of each key (pressed/released). “*Keyboard buffer*” (page 238).

```
struct KeyBuf;
```

struct Listener

Link to the generator and receiver of an event through a *callback* function “*Events*” (page 237).

```
struct Listener;
```

struct IListener

C++ interface for use class members as event handlers. “*Use of C++*” (page 45).

```
struct IListener;
```

struct DirEntry

Directory element, obtained by `hfile_dir_list`.

```
struct DirEntry
{
    String* name;
    file_type_t type;
    uint64_t size;
    Date date;
};
```

name File or subdirectory name, without path.

type Item type.
 size Size in bytes.
 date Date of last modification.

struct EvFileDir

Parameters of the event `ekEFILE` and `ekEENTRY` during automatic directory browsing. `hfile_dir_loop`.

```

struct EvFileDir
{
    const char_t* pathname;
    uint32_t level;
};

```

pathname The partial path from the parameter `pathname` of `hfile_dir_loop`.

level The depth of the directory from `pathname`.

struct ResPack

Package of resources that will be loaded together. Use `ResId` to access a specific resource. “Resources” (page 99).

```

struct ResPack;

```

struct ResId

Identifier of a resource. They are generated automatically by *nrc NAppGUI Resource Compiler*. “Resources” (page 99).

```

struct ResId;

```

struct Clock

It measures the time elapsed between two instants within the application, with microseconds precision. It is also useful for launching events at regular intervals of time.

```

struct Clock;

```

40.2. Functions

FPtr_remove

Releases the memory of an object's fields, but not the object itself. “*Registers or pointers*” (page 216).

```
void
(*FPtr_remove)(type *obj);
```

obj Pointer to the object whose fields must be released.

FPtr_event_handler

Event handler. They are *callback* functions that will be called by the generator of an event when it happens. “*Events*” (page 237).

```
void
(*FPtr_event_handler)(type *obj,
                      Event *event);
```

obj General data passed as the first parameter of the function.

event The event.

FPtr_read

Create an object from data read from a “*Streams*” (page 201). “*Serialization*” (page 221).

```
type*
(*FPtr_read)(Stream *stream);
```

stream The I/O channel where the object is serialized.

Return:

The created object, deserializing the stream data.

FPtr_read_init

Similar to `FPtr_read` where the memory of the object has already been reserved, but not initialized. “*Serialization*” (page 221).

```
void
(*FPtr_read_init)(Stream *stream,
                  type *obj);
```

stream The I/O channel where the object is serialized.

obj The object whose fields must be deserialized.

FPtr_write

Write an object in a “Streams” (page 201). “Serialization” (page 221).

```
void
(*FPtr_write)(Stream *stream,
              const type *obj);
```

stream The I/O channel where serialize the object.

obj The object to write.

core_start

Start the *core* library, reserving space for the global internal structures. Internally calls `osbs_start`.

```
void
core_start(void);
```

core_finish

Ends the *core* library, freeing the space of the global internal structures. Internally calls `osbs_finish`.

```
void
core_finish(void);
```

heap_start_mt

Start a multi-threaded section.

```
void
heap_start_mt(void);
```

Remarks:

See “Multi-thread memory” (page 197).

heap_end_mt

End a multi-thread section.

```
void
heap_end_mt(void);
```

Remarks:

See “Multi-thread memory” (page 197).

heap_verbose

Enable/disable memory auditor 'verbose' mode.

```
void
heap_verbose (bool_t verbose);
```

verbose `TRUE` to activate.

Remarks:

By default `FALSE`.

heap_stats

Enable/disable memory auditor statistics.

```
void
heap_stats (bool_t stats);
```

stats `TRUE` to activate.

Remarks:

By default `TRUE`.

heap_leaks

Returns `TRUE` if there are memory leaks at the end of execution.

```
bool_t
heap_leaks (void);
```

Return:

`TRUE` if leaks exist.

heap_malloc

Reserve a memory block with the default alignment `sizeof(void*)`.

```
byte_t*
heap_malloc (const uint32_t size,
             const char_t *name);
```

```
byte_t *mem = heap_malloc(1024 * 768, "PixelBuffer");
...
heap_free(&mem, 1024 * 768, "PixelBuffer");
```

size Size in bytes of the block.
 name Reference text for the auditor.

Return:

Pointer to the new block. Must be released with `heap_free` when it is no longer necessary.

Remarks:

Use this function for generic blocks. For types use `heap_new`.

heap_calloc

Like `heap_malloc`, but initializing the block with 0s.

```
byte_t*
heap_calloc(const uint32_t size,
            const char_t *name);
```

```
byte_t *mem = heap_calloc(256 * 256, "DrawCanvas");
/* mem = {0, 0, 0, 0, ..., 0}; */
...
heap_free(&mem, 256 * 256, "DrawCanvas");
```

size Size in bytes of the block.
 name Reference text for the auditor.

Return:

Pointer to the new block. Must be released with `heap_free` when it is no longer necessary.

Remarks:

Use this function for generic blocks. For types use `heap_new`.

heap_realloc

Reallocs an existing memory block due to the expansion or reduction of it. Guarantees that the previous content of the block is preserved `min(size, new_size)`. Try to do it without moving memory (in situ), but if it is not possible look for a new zone. It also guarantees the default alignment `sizeof(void*)` if you have to reserve a new block.

```
byte_t*
heap_realloc(byte_t *mem,
             const uint32_t size,
```



```

    const uint32_t new_size,
    const char_t *name);

```

```

byte_t *mem = heap_malloc(64, "ArrayData");
...
mem = heap_realloc(mem, 64, 128, ArrayData);
...
heap_free(&mem, 128, "ArrayData");

```

- mem Pointer to the original block to relocate.
- size Size in bytes of the original block mem.
- new_size New required size, in bytes.
- name Reference text for the auditor. It must be the same as the one used in `heap_malloc`.

Return:

Pointer to the relocated block. It will be the same as the original pointer `mem` if the relocation “in-situ” has been successful. Must be released with `heap_free` when it is no longer necessary.

Remarks:

Use this function for generic blocks. For types use `heap_realloc_n`.

heap_aligned_malloc

Reserve a memory block with alignment.

```

byte_t*
heap_aligned_malloc(const uint32_t size,
                  const uint32_t align,
                  const char_t *name);

```

```

byte_t *sse_data = heap_aligned_malloc(256 * 16, 16, "Vectors");
...
heap_free(&mem, 256 * 16, "Vectors");

```

- size Size in bytes of the block.
- align Alignment. It must be power of 2.
- name Reference text for the auditor.

Return:

Pointer to the new block. Must be released with `heap_free` when it is no longer necessary.

heap_aligned_malloc

Like `heap_aligned_malloc`, but initializing the block with 0s.

```
byte_t*
heap_aligned_malloc(const uint32_t size,
                  const uint32_t align,
                  const char_t *name);
```

```
byte_t *sse_data = heap_aligned_malloc(256 * 16, 16, "Vectors");
/* see_data = {0, 0, 0, 0, ..., 0}; */
...
heap_free(&mem, 256 * 16, "Vectors");
```

size Size in bytes of the block.

align Alignment. It must be power of 2.

name Reference text for the auditor.

Return:

Pointer to the new block. Must be released with `heap_free` when it is no longer necessary.

heap_aligned_realloc

Like `heap_realloc`, but guaranteeing memory alignment.

```
byte_t*
heap_aligned_realloc(byte_t *mem,
                   const uint32_t size,
                   const uint32_t new_size,
                   const uint32_t align,
                   const char_t *name);
```

```
byte_t *sse_data = heap_aligned_malloc(256 * 16, 16, "Vectors");
...
sse_data = heap_aligned_realloc(sse_data, 256 * 16, 512 * 16, 16, "Vectors");
...
heap_free(&mem, 512 * 16, "Vectors");
```

mem Pointer to the original block to relocate.

size Size in bytes of the original block mem.

new_size New required size, in bytes.

align Alignment. It must be power of 2.

name Text reference for the auditor. It must be the same as the one used in `heap_aligned_malloc`.

Return:

Pointer to the relocated block. Must be released with `heap_free` when it is no longer necessary.

heap_free

Free memory pointed by `mem`, previously reserved by `heap_malloc`, `heap_realloc` or its equivalents with alignment.

```
void
heap_free(byte_t **mem,
          const uint32_t size,
          const char_t *name);
```

- `mem` Double pointer to the block to be released. It will be set to `NULL` after the release.
- `size` Memory block size.
- `name` Reference text for the auditor, must be the same as that used in `heap_malloc`.

Remarks:

Use this function for generic memory blocks. For types it uses `heap_delete`.

heap_new

Reserve memory for an object. The return pointer is converted to `type`.

```
type*
heap_new(type);
```

```
MyAppCtrl *ctrl = heap_new(MyAppCtrl);
...
heap_delete(&ctrl, MyAppCtrl);
```

- `type` Object type.

Return:

Pointer to the created object. It must be destroyed by `heap_delete` when it is no longer necessary.

heap_new0

Like `heap_new`, but initializing the object with 0s.

```
type*
heap_new0 (type);
```

```
MyAppModel *model = heap_new0(MyAppModel);
/* model = {0} */
...
heap_delete (&model, MyAppModel);
```

type Object type.

Return:

Pointer to the created object. It must be destroyed by `heap_delete` when it is no longer necessary.

heap_new_n

Reserve memory for `n` objects. The return pointer is converted to `type`.

```
type*
heap_new_n(const uint32_t n,
           type);
```

```
Car *cars = heap_new_n(10, Car);
...
heap_delete_n(&cars, 10, Car);
```

n Number of objects to create.

type Object type.

Return:

Pointer to the newly created array. It must be destroyed by `heap_delete_n` when it is no longer necessary.

heap_new_n0

Like `heap_new_n`, but initializing the array with 0s.

```
type*
heap_new_n0(const uint32_t n,
            type);
```

```
Car *cars = heap_new_n0(10, Car);
/* cars = {0, 0, 0, ..., 0}; */
...
heap_delete_n(&cars, 10, Car);
```

n Number of objects to create.

type Object type.

Return:

Pointer to the newly created array. It must be destroyed by `heap_delete_n` when it is no longer necessary.

heap_realloc_n

Reallocs an array of objects created dynamically with `heap_new_n` or `heap_new_n0`. Guarantees that the previous objects remain unchanged `min(size, new_size)`.

```
type*
heap_realloc_n(type *mem,
               const uint32_t size,
               const uint32_t new_size,
               type);
```

```
Car *cars = heap_new_n(10, Car);
...
cars = heap_realloc_n(cars, 10, 20, Car);
/* cars[0]-[9] remains untouched. */
...
heap_delete_n(&cars, 20, Car);
```

mem Pointer to the array to relocate.

size Number of elements of the original array mem.

new_size New required size (in elements).

type Object type.

Return:

Pointer to the relocated array. It must be destroyed by `heap_delete_n` when it is no longer necessary.

heap_delete

Releases the object targeted by `obj`, previously reserved by `heap_new` or `heap_new0`.

```
void
heap_delete(type **obj,
            type);
```

obj Double pointer to the object to be released. It will be set to `NULL` after the release.

type Object type.

heap_delete_n

Free `n` objects targeted by `obj`, previously booked by `heap_new_n`, `heap_new_n0`.

```
void
heap_delete_n(type **obj,
              const uint32_t n,
              type);
```

obj Double pointer to the array to be released. It will be set to `NULL` after the release.

n Number of objects to be released, the same as in the reservation.

type Object type.

heap_auditor_add

Add an opaque object to the memory auditor.

```
void
heap_auditor_add(const char_t *name);
```

name Name of the object to add.

heap_auditor_delete

Releases an opaque object from the memory auditor.

```
void
heap_auditor_delete(const char_t *name);
```

name Name of the object to release.

buffer_create

Create a new buffer.

```
Buffer*
buffer_create(const uint32_t size);
```

size Buffer size in bytes.

Return:

The new buffer.

buffer_with_data

Create a new buffer and initialize it.

```
Buffer*
buffer_with_data(const byte_t *data,
                const uint32_t size);
```

data Data to initialize the buffer.

size Buffer size in bytes.

Return:

The new buffer.

buffer_destroy

Destroy the buffer.

```
void
buffer_destroy(Buffer **buffer);
```

buffer The buffer. It will be set to `NULL` after the destruction.

buffer_size

Gets the size of the buffer.

```
uint32_t
buffer_size(const Buffer *buffer);
```

buffer Buffer.

Return:

The size of the buffer in bytes.

buffer_data

Gets a pointer to the contents of the buffer.

```
byte_t*
buffer_data(Buffer *buffer);
```

buffer Buffer.

Return:

Pointer to the contents of the buffer that can be used to read or write.

buffer_const

Get a *const* pointer to the contents of the buffer.

```
const byte_t*
buffer_const(const Buffer *buffer);
```

buffer Buffer.

Return:

Pointer to the content of the buffer that can be used for reading only.

tc

Returns the inner C string in format “*UTF-8*” (page 164) contained in the String.

```
const char_t*
tc(const String *str);
```

str String object.

Return:

Pointer to the C-string.

tcc

Returns the inner C (non-const) string in “*UTF-8*” (page 164) format contained in String.

```
char_t*
tcc(String *str);
```

str String object.

Return:

Pointer to the C-string.

str_c

Create a String from a “*UTF-8*” (page 164)-encoded C string.

```
String*
str_c(const char_t *str);
```

str C UTF8 string ending in null character '\0'.

Return:

The String object.

str_cn

Create a String by copying the first *n* bytes of a C string.

```
String*
str_cn(const char_t *str,
       const uint32_t n);
```

str UTF8 C String.

n The number of bytes to copy.

Return:

The String object.

Remarks:

In “*UTF-8*” (page 164) strings, the number of bytes does not correspond to the number of characters.

str_trim

Create a String from a C string by cutting the blanks, both at the beginning and at the end.

```
String*
str_trim(const char_t *str);
```

str C UTF8 string ending in null character '\0'.

Return:

The String object.

str_trim_n

Create a String from the first `n` bytes of a C string cutting the blanks, both at the beginning and at the end.

```
String*
str_trim_n(const char_t *str,
           const uint32_t n);
```

`str` UTF8 C string.

`n` The number of bytes to consider from the original string. The copy can contain `'n'` or fewer bytes, depending on the number of blanks.

Return:

The String object.

str_copy

Create an exact copy of the String.

```
String*
str_copy(const String *str);
```

`str` The original String object.

Return:

The copy of String object.

Remarks:

Strings are a special type of mutable object. Copy involves creating a new object and not increasing a reference counter.

str_printf

Compose a String from several fields, using the the `printf` format.

```
String*
str_printf(const char_t *format,
           ...);
```

`format` String with the `printf`-like format with a variable number of parameters.

`...` Arguments or variables of the `printf`.

Return:

The String object.

Remarks:

The use of this function prevents **buffer overflow** vulnerabilities, associated with the classic C functions such as `strcpy`.

str_path

Like `str_printf`, but consider the string to be a *pathname* and therefore use the convenient separator according platform.

```
String*
str_path(const platform_t platform,
         const char_t *format,
         ...);
```

```
String *path = str_path(ekWINDOWS, "%s/img/%s.png", tc(product->category), tc(
    ↪ product->name));
path = "\\camera\\img\\sony_a5000.png"
```

platform Platform for which the *pathname* is created.

format String with the printf-like format with a variable number of parameters.

... Arguments or variables of the printf.

Return:

The String object.

str_cpath

Like `str_path`, but considering the platform where the program is running.

```
String*
str_cpath(const char_t *format,
         ...);
```

```
String *path = str_cpath("%s/img/%s.png", tc(product->category), tc(product->
    ↪ name));
path = "\\camera\\img\\sony_a5000.png" // In Windows
path = "/camera/img/sony_a5000.png" // In Unix-like
```

format String with the printf-like format with a variable number of parameters.

... Arguments or variables of the printf.

Return:

The String object.

str_relpath

Calculate the relative path to path1 to get to path2.

```
String*
str_relpath(const platform_t platform,
            const char_t *path1,
            const char_t *path2);
```

platform Platform for which the path is calculated (directory separator).

path1 The origin path.

path2 The destination path.

Return:

The string object that contains the relative path.

str_crepath

Calculate the relative path to path1 to get to path2.

```
String*
str_crepath(const char_t *path1,
            const char_t *path2);
```

path1 The origin path.

path2 The destination path.

Return:

The string object that contains the relative path.

Remarks:

Same as `str_relpath`, but using the directory separator of the platform where the program is running.

str_repl

Create a String by replacing an undetermined number of sub-strings. The first parameter is the original string. The following pairs indicate the sub-string to be searched and the sub-string that should replace it. The last parameter must be `NULL`.

```
String*
str_repl(const char_t *str,
        ...);
```

```
String *str = str_repl("const Product **pr;", "const", "", "*", "", " ", "",
    ↪ NULL);
str = "Productpr;"
```

str Original C UTF8 string terminated in null character '\0'.

... Variable number of parameters, in pairs. The first element of the pair indicates the sub-string to look for in `str`. The second element replaces it. The last value must be `NULL`.

Return:

The String object.

str_reserve

Create a String with `n+1` bytes, but without assigning any content.

```
String*
str_reserve(const uint32_t n);
```

n Number of bytes. Reserve space for one more (the '\n').

Return:

The String object. Its content will be indeterminate (garbage). It must be written later.

str_fill

Create a String by repeating `n` times the same character.

```
String*
str_fill(const uint32_t n,
        const char_t c);
```

n Number of characters.

c Pattern character.

Return:

The String object.

str_read

Create a String by reading its contents from a `Stream` (de-serialization). String must have been previously written by `str_write`.

```
String*
str_read(Stream *stream);
```

stream A read *stream*.

Return:

The String object.

Remarks:

It is a **binary** operation. String size is deserialized first.

str_write

Write a string in a “Streams” (page 201) (serialization).

```
void
str_write(Stream *stream,
          String *str);
```

stream A write *stream*.

str The String object.

Remarks:

It is a **binary** operation. The string size is serialized first. Use `str_writef` to write only the text.

str_writef

Write in a “Streams” (page 201) the C string contained in the string.

```
void
str_writef(Stream *stream,
           String *str);
```

stream A write *stream*.

str The String object.

Remarks:

Write only the *string* text, **without the null final character '0'**. It is equivalent to `stm_writef(stream, tc(str));` but more efficient, since you don't have to calculate the size of `str`.

str_copy_c

Copy the C string `src` in the buffer pointed by `dest`, including the null character `'\0'`.

```
void
str_copy_c(char_t *dest,
           const uint32_t size,
           const char_t *str);
```

`dest` Destination Buffer.

`size` Size in bytes of `dest`.

`str` UTF8 C string terminated in null character `'\0'`.

Remarks:

It is a safe operation. They will not be written in `dest` more of `size` bytes and a character will never be truncated. `dest` it will always end the null character `'\0'`.

str_copy_cn

Copy in `dest` a maximum of `n` bytes of the C UTF8 string pointed by `src`, including the null character `'\0'`.

```
void
str_copy_cn(char_t *dest,
           const uint32_t size,
           const char_t *str,
           const uint32_t n);
```

`dest` Destination Buffer.

`size` Size in bytes of `dest`.

`str` UTF8 C string.

`n` Maximum number of bytes to copy in `dest`.

Remarks:

It is a safe operation. They will not be written in `dest` more of `n` bytes and a character will never be truncated. `dest` it will always end the null character `'\0'`.

str_cat

Dynamically concatenates the content of `src` in `dest`.

```
void
str_cat(String **dest,
       const char_t *src);
```

****dest** *String* object of origin and destination.
src UTF8 C string to concatenate.

Remarks:

This operation involves reallocating dynamic memory. To compose long texts it is more efficient to use `Stream`.

str_cat_c

Concatenate the content of `src` in `dest`. The null character in `dest` will be overwritten by the first character of `src`.

```
void
str_cat_c(char_t *dest,
          const uint32_t size,
          const char_t *src);
```

dest UTF8 C string origin and destination.
size Size in bytes of `dest`.
src UTF8 C string to concatenate.

Remarks:

It is a safe operation. They will not be written in `dest` more of `size` bytes and a character will never be truncated. `dest` it will always end the null character `'\0'`.

str_upd

Change the content of a *string* to another.

```
void
str_upd(String **str,
        const char_t *new_str);
```

```
// Equivalent code
String *str = ..original content..
String *temp = str_c(new_str);
str_destroy(&str);
str = temp;
temp = NULL;
```

str Destination *string* object. The original content will be deleted.
new_str UTF8 C string that will replace the original.

str_destroy

Destroy a string object.

```
void
str_destroy(String **str);
```

str The string object. Will be set to `NULL` after destruction.

str_destopt

Destroy a string object if its content is not `NULL` (optional destroyer).

```
void
str_destopt(String **str);
```

str The string object. Will be set to `NULL` after destruction.

str_len

Returns the size in bytes of a string.

```
uint32_t
str_len(const String *str);
```

str The String object.

Return:

The number of bytes, not including the null character `'\0'`.

Remarks:

In “*UTF-8*” (page 164) strings the number of bytes is not the same as the characters. `str_nchars`.

str_len_c

Returns the size in bytes of a UTF8 C string.

```
uint32_t
str_len_c(const char_t *str);
```

str UTF8 C string terminated in null character `'\0'`.

Return:

The number of bytes, not including the null character `'\0'`.

Remarks:

In “*UTF-8*” (page 164) strings the number of bytes is not the same as the characters. `str_nchars`.

str_nchars

Returns the number of characters of a string object.

```
uint32_t
str_nchars(const String *str);
```

`str` The String object.

Return:

The number of characters, not including the null character `'\0'`.

Remarks:

In “*UTF-8*” (page 164) strings the number of bytes is not the same as the characters.

str_prefix

Locate the common begin of two strings.

```
uint32_t
str_prefix(const char_t *str1,
          const char_t *str2);
```

`str1` First UTF8 C string terminated in null character `'\0'`.

`str2` Second UTF8 C string terminated in null character `'\0'`.

Return:

The number of bytes that are identical at the beginning of both strings.

str_is_prefix

Check if one string is prefix of another.

```
bool_t
str_is_prefix(const char_t *str,
             const char_t *prefix);
```

`str` UTF8 C string terminated in null character `'\0'`.

`prefix` Prefix of `str` terminated in null character `'\0'`.

Return:

`TRUE` if `prefix` is prefix of `str`.

str_is_sufix

Check if one string is a suffix of another.

```
bool_t
str_is_sufix(const char_t *str,
            const char_t *sufix);
```

`str` Null-terminated UTF8 C string `'\0'`.

`sufix` Suffix of `str` terminated in null character `'\0'`.

Return:

`TRUE` si `sufix` is suffix of `str`.

str_scmp

Compare two strings alphabetically.

```
int
str_scmp(const String *str1,
        const String *str2);
```

`str1` First string.

`str2` Second string.

Return:

Comparison result.

str_cmp

Compare alphabetically a string with a UTF8 C string.

```
int
str_cmp(const String *str1,
        const char_t *str2);
```

`str1` String object.

`str2` C UTF8 string terminated in null character `'\0'`.

Return:

Comparison result.

str_cmp_c

Compare alphabetically two UTF8 C strings terminated in a null character '\0'.

```
int
str_cmp_c(const char_t *str1,
          const char_t *str2);
```

str1 First UTF8 C string.

str2 Second UTF8 C string.

Return:

Comparison result.

str_cmp_cn

Compare alphabetically the first `n` bytes of two UTF8 C strings terminated in a null character '\0'.

```
int
str_cmp_cn(const char_t *str1,
           const char_t *str2,
           const uint32_t n);
```

str1 First UTF8 C string.

str2 Second UTF8 C string.

n Maximum number of bytes to compare.

Return:

Comparison result.

Remarks:

It is a safe operation. If either of the two chains reaches the end before reaching `n` bytes, the comparison ends.

str_empty

Check if a string is empty (`str->data[0] == '\0'`).

```
bool_t
str_empty(const String *str);
```

str The String object.

Return:

`TRUE` if it is empty or is `NULL`.

str_empty_c

Check if a UTF8 C string is empty (`str[0] == '\0'`).

```
bool_t
str_empty_c(const char_t *str);
```

`str` UTF8 C string.

Return:

`TRUE` if it is empty or is `NULL`.

str_equ

Check if the content of a string is equal to a C string.

```
bool_t
str_equ(const String *str1,
        const char_t *str2);
```

`str1` String object.

`str2` UTF8 C string terminated in null character `'\0'`.

Return:

`TRUE` if they are equals.

str_equ_c

Check if two UTF8 C strings are equal.

```
bool_t
str_equ_c(const char_t *str1,
          const char_t *str2);
```

`str1` First UTF8 C string terminated in null character `'\0'`.

`str2` Second UTF8 C string terminated in null character `'\0'`.

Return:

`TRUE` if they are equals.

str_equ_cn

Check if the first bytes of two UTF8 C strings are equal.

```
bool_t
str_equ_cn(const char_t *str1,
           const char_t *str2,
           const uint32_t n);
```

str1 First UTF8 C string terminated in null character '\0'.

str2 Second UTF8 C string terminated in null character '\0'.

n First 'n' bytes to compare.

Return:

TRUE if they are equals.

Remarks:

If '\0' is reached in either of the two strings, **TRUE** will be returned.

str_equ_nocase

Check if two UTF8 C strings are equal, ignoring upper or lower case.

```
bool_t
str_equ_nocase(const char_t *str1,
               const char_t *str2);
```

str1 First UTF8 C string terminated in null character '\0'.

str2 Second UTF8 C string terminated in null character '\0'.

Return:

TRUE if they are equals.

Remarks:

Only US-ASCII characters are considered (0-127).

str_equ_end

Check the termination of a string.

```
bool_t
str_equ_end(const char_t *str,
            const char_t *end);
```

str UTF8 C string terminated in null character '\0'.
 end UTF8 C string with termination.

Return:

TRUE if str ends in end.

str_upper

Change lowercase letters to uppercase.

```
void
str_upper(String *str);
```

str The String object.

Remarks:

Only US-ASCII characters (0-127) are considered. The original string will change, but not the memory requirements.

str_lower

Change uppercase letters to lowercase letters.

```
void
str_lower(String *str);
```

str The String object.

Remarks:

Only US-ASCII characters (0-127) are considered. The original string will change, but not the memory requirements.

str_upper_c

Convert a string to uppercase.

```
void
str_upper_c(char_t *dest,
            const uint32_t size,
            const char_t *str);
```

dest Destination buffer.

size Size in bytes of the destination buffer.

str String C UTF8 terminated in null character '\0'.

Remarks:

Only US-ASCII characters are considered (0-127).

str_lower_c

Convert a string to lowercase.

```
void
str_lower_c(char_t *dest,
            const uint32_t size,
            const char_t *str);
```

dest Destination buffer.

size Size in bytes of the destination buffer.

str String C UTF8 terminated in null character '\0'.

Remarks:

Only US-ASCII characters are considered (0-127).

str_subs

Change all instances of one character to another.

```
void
str_subs(String *str,
        const char_t replace,
        const char_t with);
```

```
String *str = str_c("customer.service.company.com");
str_subs(str, '.', '_');
str_uppercase(str);
str="CUSTOMER_SERVICE_COMPANY_COM"
```

str The String object.

replace Character to replace.

with Replacement character.

Remarks:

Only US-ASCII characters (0-127) are considered. The original string will change, but not the memory requirements.

str_repl_c

Change all instances of one substring to another.

```
void
str_repl_c(String *str,
           const char_t *replace,
           const char_t *with);
```

str The String object.

replace Substring to replace.

with Replacement substring.

Remarks:

The substrings `replace` and `with` they must be the same size, otherwise a “*Asserts*” (page 159) will be triggered. Use `str_repl` for the general case.

str_str

Search for a substring within a larger one.

```
const char_t*
str_str(const char_t *str,
        const char_t *substr);
```

str UTF8 C strings terminated in null character `'\0'`.

substr Substring to search terminated in null character `'\0'`.

Return:

Pointer to the first occurrence of `substr` in `str` or `NULL` if there is none.

str_split

Divide a string into two, using the first occurrence of a substring.

```
bool_t
str_split(const char_t *str,
          const char_t *substr,
          String **left,
          String **right);
```

```
const char_t *str = "one::two";
String *str1, *str2, *str3;
bool_t ok1, ok2;
ok1 = str_split(str, "::", &str1, &str2);
ok2 = str_split(tc(str1), "::", NULL, &str3);
```

```

str1 = "one"
str2 = "two"
str3 = ""
ok1 = TRUE
ok2 = FALSE

```

- str UTF8 C string terminated in null character '\0'.
- substr Substring to search.
- left Left substring. It will be equal to str if substr does not exist. The parameter can be `NULL` if not necessary.
- right Right substring. It will be equal to "" if substr does not exist. The parameter can be `NULL` if not necessary.

Return:

`TRUE` if substr exists in str.

Remarks:

If `NULL` is not used, left and right will always return a valid string, even if it is empty.

str_split_trim

Like `str_split` but removing all the blanks at the beginning and end of left and right.

```

bool_t
str_split_trim(const char_t *str,
               const char_t *substr,
               String **left,
               String **right);

```

- str UTF8 C string terminated in null character '\0'.
- substr Substring to search.
- left Left substring.
- right Right substring.

Return:

`TRUE` if substr exists in str.

Remarks:

If `NULL` is not used, left and right will always return a valid string, even if it is empty.

str_splits

Splits a string into several, using a substring as a separator.

```

ArrPt(String)*
str_splits(const char_t *str,
           const char_t *substr,
           const bool_t trim,
           const bool_t add_empty);

// strs will be a 0-size array
const char_t *str = "|| || ||";
ArrPt(String) *strs = str_splits(str, "|", TRUE, FALSE);

// strs will be a 7-size array of empty strings
const char_t *str = "|| || ||";
ArrPt(String) *strs = str_splits(str, "|", TRUE, TRUE);

```

str UTF8 C string terminated in null character '\0'.

substr Substring to search (separator). It can be `NULL`.

trim If `TRUE`, substrings will remove leading and trailing whitespace.

add_empty If `TRUE`, empty strings will be added to the result.

Return:

Array with the substrings found. It must be destroyed with `arrpt_destroy(&array, str_destroy, String)`.

Remarks:

trim is applied first and then add_empty.

str_split_pathname

Divide a *pathname* into path and file “*Filename and pathname*” (page 186).

```

void
str_split_pathname(const char_t *pathname,
                  String **path,
                  String **file);

String *path, *name, *name2;
str_split_pathname("C:\\Users\\john\\Desktop\\image.png", &path, &name);
str_split_pathname(tc(path), NULL, name2);
path = "C:\\Users\\john\\Desktop"
name = "image.png"
name2 = "Desktop"

```

- pathname Input pathname.
- path Directory path. The parameter can be `NULL` if not necessary.
- file File name or final directory. The parameter can be `NULL` if not necessary.

str_split_pathext

Like `str_split_pathname` but also extracting the file extension.

```
void
str_split_pathext(const char_t *pathname,
                 String **path,
                 String **file,
                 String **ext);
```

```
String *path, *name, *ext;
str_split_pathext("C:\\Users\\john\\Desktop\\image.png", &path, &name, &ext);
path = "C:\\Users\\john\\Desktop"
name = "image"
ext = "png"
```

- pathname Input pathname.
- path Path part.
- file File part.
- ext File extension.

str_filename

Returns the final part of a *pathname*. “*Filename and pathname*” (page 186).

```
const char_t*
str_filename(const char_t *pathname);
```

```
const char_t *name = str_filename("C:\\Users\\john\\Desktop\\image.png");
name = "image.png"
```

- pathname Input pathname.

Return:

The last part of a directory path.

str_filext

Returns the file extension, from a *pathname*. “*Filename and pathname*” (page 186).

```
const char_t*
str_fileext(const char_t *pathname);
```

```
const char_t *ext = str_fileext("C:\\Users\\john\\Desktop\\image.png");
ext = "png"
```

pathname Input pathname.

Return:

The file extension.

str_find

Search for a string in an array.

```
uint32_t
str_find(const ArrPt(String) *array,
         const char_t *str);
```

array Array.

str The string to find.

Return:

The position of the string or `UINT32_MAX` if it does not exist.

str_to_i8

Converts a text string into an integer.

```
int8_t
str_to_i8(const char_t *str,
          const uint32_t base,
          bool_t *error);
```

str Text string, ending in null character '\0'.

base Numeric base: 8 (octal), 10 (decimal), 16 (hexadecimal).

error Gets `TRUE` if there is an error in the conversion. Can be `NULL`.

Return:

The numerical value.

Remarks:

If the string is wrong or the value is out of range, return 0 with `error=TRUE`.

str_to_i16

Converts a text string into an integer.

```
int16_t
str_to_i16(const char_t *str,
           const uint32_t base,
           bool_t *error);
```

str Text string, ending in null character '\0'.

base Numeric base: 8 (octal), 10 (decimal), 16 (hexadecimal).

error Gets **TRUE** if there is an error in the conversion. Can be **NULL**.

Return:

The numerical value.

Remarks:

If the string is wrong or the value is out of range, return 0 with error=**TRUE**.

str_to_i32

Converts a text string into an integer.

```
int32_t
str_to_i32(const char_t *str,
           const uint32_t base,
           bool_t *error);
```

str Text string, ending in null character '\0'.

base Numeric base: 8 (octal), 10 (decimal), 16 (hexadecimal).

error Gets **TRUE** if there is an error in the conversion. Can be **NULL**.

Return:

The numerical value.

Remarks:

If the string is wrong or the value is out of range, return 0 with error=**TRUE**.

str_to_i64

Converts a text string into an integer.

```
int64_t
str_to_i64(const char_t *str,
          const uint32_t base,
          bool_t *error);
```

str Text string, ending in null character '\0'.

base Numeric base: 8 (octal), 10 (decimal), 16 (hexadecimal).

error Gets **TRUE** if there is an error in the conversion. Can be **NULL**.

Return:

The numerical value.

Remarks:

If the string is wrong or the value is out of range, return 0 with error=**TRUE**.

str_to_u8

Converts a text string into an integer.

```
uint8_t
str_to_u8(const char_t *str,
         const uint32_t base,
         bool_t *error);
```

str Text string, ending in null character '\0'.

base Numeric base: 8 (octal), 10 (decimal), 16 (hexadecimal).

error Gets **TRUE** if there is an error in the conversion. Can be **NULL**.

Return:

The numerical value.

Remarks:

If the string is wrong or the value is out of range, return 0 with error=**TRUE**.

str_to_u16

Converts a text string into an integer.

```
uint16_t
str_to_u16(const char_t *str,
          const uint32_t base,
          bool_t *error);
```

- str Text string, ending in null character '\0'.
- base Numeric base: 8 (octal), 10 (decimal), 16 (hexadecimal).
- error Gets **TRUE** if there is an error in the conversion. Can be **NULL**.

Return:

The numerical value.

Remarks:

If the string is wrong or the value is out of range, return 0 with error=**TRUE**.

str_to_u32

Converts a text string into an integer.

```
uint32_t
str_to_u32(const char_t *str,
          const uint32_t base,
          bool_t *error);
```

- str Text string, ending in null character '\0'.
- base Numeric base: 8 (octal), 10 (decimal), 16 (hexadecimal).
- error Gets **TRUE** if there is an error in the conversion. Can be **NULL**.

Return:

The numerical value.

Remarks:

If the string is wrong or the value is out of range, return 0 with error=**TRUE**.

str_to_u64

Converts a text string into an integer.

```
uint64_t
str_to_u64(const char_t *str,
          const uint32_t base,
          bool_t *error);
```

- str Text string, ending in null character '\0'.
- base Numeric base: 8 (octal), 10 (decimal), 16 (hexadecimal).
- error Gets **TRUE** if there is an error in the conversion. Can be **NULL**.

Return:

The numerical value.

Remarks:

If the string is wrong or the value is out of range, return 0 with `error=TRUE`.

str_to_r32

Convert a string of text into a real.

```
real32_t
str_to_r32(const char_t *str,
          bool_t *error);
```

`str` Text string, ending in null character `'\0'`.

`error` Gets `TRUE` if there is an error in the conversion. Can be `NULL`.

Return:

The numerical value.

Remarks:

If the string is wrong or the value is out of range, return 0.0 with `error=TRUE`.

str_to_r64

Convert a string of text into a real.

```
real64_t
str_to_r64(const char_t *str,
          bool_t *error);
```

`str` Text string, ending in null character `'\0'`.

`error` Gets `TRUE` if there is an error in the conversion. Can be `NULL`.

Return:

The numerical value.

Remarks:

If the string is wrong or the value is out of range, return 0.0 with `error=TRUE`.

stm_from_block

Create a read stream from an existing memory block.

```
Stream*
stm_from_block(const byte_t *data,
               const uint32_t size);
```

data Pointer to the memory block.

size Size in bytes of the memory block.

Return:

The stream.

Remarks:

The original block will not be modified (read only). When the end of the block is reached `stm_state` will return `ekSTEND`. “*Block stream*” (page 203).

stm_memory

Create a read/write memory stream.

```
Stream*
stm_memory(const uint32_t size);
```

size Initial buffer size (in bytes). It will grow if necessary.

Return:

The stream.

Remarks:

It can be used as an internal pipeline for the information exchange between functions or threads. It behaves like a FIFO (*First In First Out*) buffer. For multi-threaded access you must be protected with a `Mutex`. “*Memory stream*” (page 203).

stm_from_file

Create a stream to read from a file on disk.

```
Stream*
stm_from_file(const char_t *pathname,
              ferror_t *error);
```

pathname File *pathname*. “*Filename and pathname*” (page 186).

error Error code if the function fails. Can be `NULL`.

Return:

The stream or `NULL` if the file opening fails.

Remarks:

“*File stream*” (page 202).

stm_to_file

Create a stream to write data to a file on disk.

```
Stream*
stm_to_file(const char_t *pathname,
            ferror_t *error);
```

pathname File *pathname*. “*Filename and pathname*” (page 186).

error Error code if the function fails. Can be `NULL`.

Return:

The stream or `NULL` if file creation fails.

Remarks:

If the file already exists it will be overwritten. “*File stream*” (page 202).

stm_append_file

Create a stream to write data to the end of an existing file.

```
Stream*
stm_append_file(const char_t *pathname,
                ferror_t *error);
```

pathname File *pathname*. “*Filename and pathname*” (page 186).

error Error code if the function fails. Can be `NULL`.

Return:

The stream or `NULL` if the file opening fails.

Remarks:

It will fail if the file does not exist (do not create it). “*File stream*” (page 202).

stm_socket

Create a stream from a socket.

```
Stream*
stm_socket(Socket *socket);
```

socket Client or server socket.

Return:

The stream.

Remarks:

Allows to use the streams functionality to read or write to a remote process. The socket must have been previously created with `bsocket_connect` (client) or `bsocket_accept` (server). The stream will close the socket at `stm_close`. `bsocket_close` should not be called. See “*Socket stream*” (page 202).

stm_close

Close the stream. All resources such as file descriptors or *sockets* will be released. Before to closing, the data will be written to the channel `stm_flush`.

```
void
stm_close(Stream **stm);
```

stm The stream. Will be set to `NULL` after closing.

stm_get_write_endian

Get the current byte order when writing to the stream.

```
endian_t
stm_get_write_endian(const Stream *stm);
```

stm The stream.

Return:

The “*Byte order*” (page 213).

stm_get_read_endian

Get the current byte order when reading from the stream.

```
endian_t
stm_get_read_endian(const Stream *stm);
```

stm The stream.

Return:

The “*Byte order*” (page 213).

stm_set_write_endian

Set the order of bytes when writing to the stream, from now on.

```
void
stm_set_write_endian(Stream *stm,
                    const endian_t endian);
```

stm The stream.

endian The “*Byte order*” (page 213).

Remarks:

Default is `ekLITEND`, except in sockets that will be `ekBIGEND`.

stm_set_read_endian

Set the order of bytes when reading from the stream, from now on.

```
void
stm_set_read_endian(Stream *stm,
                   const endian_t endian);
```

stm The stream.

endian The “*Byte order*” (page 213).

Remarks:

Default is `ekLITEND`, except in sockets that will be `ekBIGEND`.

stm_get_write_utf

Gets the UTF encoding with which the texts are being written in the stream.

```
unicode_t
stm_get_write_utf(const Stream *stm);
```

stm The stream.

Return:

“*UTF encodings*” (page 163).

Remarks:

See “*Text stream*” (page 206).

stm_get_read_utf

Get the UTF encoding with which the texts are being read in the stream.

```
unicode_t
stm_get_read_utf(const Stream *stm);
```

stm The stream.

Return:

“*UTF encodings*” (page 163).

Remarks:

See “*Text stream*” (page 206).

stm_set_write_utf

Set the UTF encoding when writing texts in the stream, from now on.

```
void
stm_set_write_utf(Stream *stm,
                 const unicode_t format);
```

stm The stream.

format “*UTF encodings*” (page 163).

Remarks:

See “*Text stream*” (page 206).

stm_set_read_utf

Set the UTF encoding when reading texts in the stream, from now on.

```
void
stm_set_read_utf(Stream *stm,
                 const unicode_t format);
```

stm The stream.

format “*UTF encodings*” (page 163).

Remarks:

See “*Text stream*” (page 206).

stm_is_memory

Gets if it is a memory-resident stream.

```
bool_t
stm_is_memory(const Stream *stm);
```

stm The stream.

Return:

TRUE if it was created by `stm_from_block` or `stm_memory`.

stm_bytes_written

Gets the total bytes written in the stream since its creation.

```
uint64_t
stm_bytes_written(const Stream *stm);
```

stm The stream.

Return:

The total number of bytes written.

stm_bytes_readed

Get the total bytes read from the stream since its creation.

```
uint64_t
stm_bytes_readed(const Stream *stm);
```

stm The stream.

Return:

The total number of bytes readed.

stm_col

Get the column in text streams.

```
uint32_t
stm_col(const Stream *stm);
```

stm The stream.

Return:

Column number.

Remarks:

When we read characters in text streams with `stm_read_char` or derivatives, the columns and rows are counted in a similar way as text editors do. This information can be useful when displaying warnings or error messages. In mixed streams (binary + text), the count stops when reading binary data and continues when reading the text is resumed. View “*Text stream*” (page 206).

stm_row

Get row in text streams.

```
uint32_t
stm_row(const Stream *stm);
```

stm The stream.

Return:

Row number.

Remarks:

See `stm_col`.

stm_token_col

Gets the column of the last token read.

```
uint32_t
stm_token_col(const Stream *stm);
```

stm The stream.

Return:

Column number.

Remarks:

It only takes effect after calling `stm_read_token` or derivatives. See `stm_col` and “*Tokens*” (page 207).

stm_token_row

Gets the row of the last token read.

```
uint32_t
stm_token_row(const Stream *stm);
```

stm The stream.

Return:

Row number.

Remarks:

It only takes effect after calling `stm_read_token` or derivatives. See `stm_col` and “*Tokens*” (page 207).

stm_token_lexeme

Gets the lexeme of the last token read.

```
const char_t*
stm_token_lexeme(const Stream *stm);
```

stm The stream.

Return:

The lexeme. It is stored in a temporary buffer and will be lost when reading the next token. If you need it, make a copy with `str_c`.

Remarks:

It only takes effect after calling `stm_read_token` or derivatives. See `stm_col` and “*Tokens*” (page 207).

stm_token_escapes

Escape sequences option when reading tokens.

```
void
stm_token_escapes(const Stream *stm,
                  const bool_t active_escapes);
```

stm The stream.

active_escapes **TRUE** the escape sequences will be processed when reading **ekTSTRING** tokens. For example, the sequence "\n" will become the character 0x0A (10). **FALSE** will ignore escape sequences, reading strings literally. By default **FALSE**.

Remarks:

It will take effect on the next call to `stm_read_token`. See “*Tokens*” (page 207).

stm_token_spaces

Blanks option when reading tokens.

```
void
stm_token_spaces(const Stream *stm,
                 const bool_t active_spaces);
```

stm The stream.

active_spaces **TRUE** **ekTSPACE** tokens will be returned when finding sequences of whitespace. **FALSE** will ignore whitespace. By default **FALSE**.

Remarks:

It will take effect on the next call to `stm_read_token`. See “*Tokens*” (page 207).

stm_token_comments

Comments option when reading tokens.

```
void
stm_token_comments(const Stream *stm,
                   const bool_t active_comments);
```

stm The stream.

active_comments **TRUE** an **ekTMLCOM** token will be returned every time it encounters C comments `/ * Comment */` and **ekTSLCOM** for comments `C++ // Comment`. **FALSE** comments will be ignored. By default **FALSE**.

Remarks:

It will take effect on the next call to `stm_read_token`. See “*Tokens*” (page 207).

stm_state

Get the current state of the stream.

```
sstate_t
stm_state(const Stream *stm);
```

stm The stream.

Return:

The “*Stream state*” (page 214).

stm_file_err

Get additional information about the error, in disk streams.

```
error_t
stm_file_err(const Stream *stm);
```

stm The stream.

Return:

File error.

Remarks:

It is only relevant in “*File stream*” (page 202) with the state `ekSTBROKEN`.

stm_sock_err

Get additional information about the error, in network streams.

```
serror_t
stm_sock_err(const Stream *stm);
```

stm The stream.

Return:

Socket error.

Remarks:

It is only relevant in “*Socket stream*” (page 202) with the state `ekSTBROKEN`.

stm_corrupt

Set the stream status to `ekSTCORRUPT`.

```
void
stm_corrupt(Stream *stm);
```

`stm` The stream.

Remarks:

Sometimes, it is the application that detects that the data is corrupted since the data semantics wasn't expected.

stm_str

Create a string with the current content of the internal buffer. It is only valid for stream in memory. `stm_memory`.

```
String*
stm_str(const Stream *stm);
```

`stm` The stream.

Return:

The string with the buffer content.

stm_buffer

Gets a pointer to the current content of the internal buffer. Only valid for stream in memory. `stm_memory`.

```
const byte_t*
stm_buffer(const Stream *stm);
```

`stm` The stream.

Return:

Internal buffer pointer.

Remarks:

This pointer is read only. Writing here will have unexpected consequences.

stm_buffer_size

Get the current size of the internal buffer. Only valid for stream in memory. `stm_memory`.

```
uint32_t
stm_buffer_size(const Stream *stm);
```

`stm` The stream.

Return:

The size of the internal buffer (in bytes).

stm_write

Write bytes in the stream.

```
void
stm_write(Stream *stm,
          const byte_t *data,
          const uint32_t size);
```

`stm` The stream.

`data` Pointer to the data block to write.

`size` Number of bytes to write.

Remarks:

The block is written as is, regardless of the “*Byte order*” (page 213) neither the “*UTF encodings*” (page 163).

stm_write_char

Write a Unicode character in the stream.

```
void
stm_write_char(Stream *stm,
              const uint32_t codepoint);
```

`stm` The stream.

`codepoint` The “*Unicode*” (page 161) value of character.

Remarks:

The encoding can be changed with `stm_set_write_utf`.

stm_printf

Write text in the stream, using the `printf` format .

```
uint32_t
stm_printf(Stream *stm,
           const char_t *format,
           ...);
```

```
stm_printf(stream, Code: %-10s Price %5.2f\n", code, price);
```

`stm` The stream.

`format` String with the `printf`-like format with a variable number of parameters.

`...` Arguments or variables of the `printf`.

Return:

The number of bytes written.

Remarks:

The final null character (`'\0'`) will not be written. The encoding can be changed with `stm_set_write_utf`.

stm_writef

Writes a UTF8 C string in the stream.

```
uint32_t
stm_writef(Stream *stm,
           const char_t *str);
```

`stm` The stream.

`str` C UTF8 string terminated in null character `'\0'`.

Return:

The number of bytes written.

Remarks:

The final null character (`'\0'`) will not be written. This function is faster than `stm_printf` when the string is constant and does not need formatting. For `String` objects use `str_writef`. The encoding can be changed with `stm_set_write_utf`.

stm_write_bool

Write a `bool_t` variable in the stream.

```
void
stm_write_bool(Stream *stm,
               const bool_t value);
```

stm The stream.

value Value to write.

Remarks:

It is a binary write. Do not use in “pure” text streams.

stm_write_i8

Write a `int8_t` variable in the stream.

```
void
stm_write_i8(Stream *stm,
             const int8_t value);
```

stm The stream.

value Value to write.

Remarks:

It is a binary write. Do not use in “pure” text streams.

stm_write_i16

Write a `int16_t` variable in the stream.

```
void
stm_write_i16(Stream *stm,
              const int16_t value);
```

stm The stream.

value Value to write.

Remarks:

It is a binary write. Do not use in “pure” text streams. “*Byte order*” (page 213).

stm_write_i32

Write a `int32_t` variable in the stream.

```
void
stm_write_i32(Stream *stm,
              const int32_t value);
```

stm The stream.

value Value to write.

Remarks:

It is a binary write. Do not use in “pure” text streams. “*Byte order*” (page 213).

stm_write_i64

Write a `int64_t` variable in the stream.

```
void
stm_write_i64(Stream *stm,
              const int64_t value);
```

stm The stream.

value Value to write.

Remarks:

It is a binary write. Do not use in “pure” text streams. “*Byte order*” (page 213).

stm_write_u8

Write a `uint8_t` variable in the stream.

```
void
stm_write_u8(Stream *stm,
             const uint8_t value);
```

stm The stream.

value Value to write.

Remarks:

It is a binary write. Do not use in “pure” text streams.

stm_write_u16

Write a `uint16_t` variable in the stream.

```
void
stm_write_u16(Stream *stm,
              const uint16_t value);
```

stm The stream.

value Value to write.

Remarks:

It is a binary write. Do not use in “pure” text streams. “*Byte order*” (page 213).

stm_write_u32

Write a `uint32_t` variable in the stream.

```
void
stm_write_u32(Stream *stm,
              const uint32_t value);
```

stm The stream.

value Value to write.

Remarks:

It is a binary write. Do not use in “pure” text streams. “*Byte order*” (page 213).

stm_write_u64

Write a `uint64_t` variable in the stream.

```
void
stm_write_u64(Stream *stm,
              const uint64_t value);
```

stm The stream.

value Value to write.

Remarks:

It is a binary write. Do not use in “pure” text streams. “*Byte order*” (page 213).

stm_write_r32

Write a `real32_t` variable in the stream.

```
void
stm_write_r32(Stream *stm,
              const real32_t value);
```

stm The stream.

value Value to write.

Remarks:

It is a binary write. Do not use in “pure” text streams. “Byte order” (page 213).

stm_write_r64

Write a `real64_t` variable in the stream.

```
void
stm_write_r64(Stream *stm,
              const real64_t value);
```

stm The stream.

value Value to write.

Remarks:

It is a binary write. Do not use in “pure” text streams. “Byte order” (page 213).

stm_write_enum

Write a `enum` variable in the stream.

```
void
stm_write_enum(Stream *stm,
               const type value,
               type);
```

stm The stream.

value Value to write.

type The `enum` type.

Remarks:

It is a binary write. Do not use in “pure” text streams. “Byte order” (page 213).

stm_read

Read bytes from the stream.

```
uint32_t
stm_read(Stream *stm,
         byte_t *data,
         const uint32_t size);
```

stm The stream.

data Pointer to the buffer where the read data will be written.

size The number of bytes to read (buffer size).

Return:

The number of bytes actually read.

stm_read_char

Read a text character from the stream.

```
uint32_t
stm_read_char(Stream *stm);
```

stm The stream.

Return:

The Unicode character code.

Remarks:

The encoding of the input text can be changed with `stm_set_read_utf`.

stm_read_chars

Read several characters from the stream.

```
const char_t*
stm_read_chars(Stream *stm,
              const uint32_t n);
```

stm The stream.

n The number of characters to read.

Return:

Pointer to the UTF8 C string read. It will end with the null character `'\0'`.

Remarks:

The returned pointer is temporary and will be overwritten in the next reading. If necessary, make a copy with `str_c`. The encoding of the input text can be changed with `stm_set_read_utf`.

stm_read_line

Read stream characters until an end of line is reached `'\n'`.

```
const char_t*
stm_read_line(Stream *stm);
```

`stm` The stream.

Return:

Pointer to the UTF8 C string, terminated with the null character `'\0'`. The characters `'\n'` or `'\r\n'` will not be included in the result. `NULL` will be returned when the end of the stream is reached.

Remarks:

The returned pointer is temporary and will be overwritten in the next reading. If necessary, make a copy with `str_c`. The encoding of the input text can be changed with `stm_set_read_utf`.

stm_read_trim

Read the following sequence of characters removing the blank spaces.

```
const char_t*
stm_read_trim(Stream *stm);
```

`stm` The stream.

Return:

Pointer to the C UTF8 string read. It will end with the null character `'\0'`.

Remarks:

Useful for reading strings from text streams. It will ignore all leading blanks and read characters until the first blank is found (`' '`, `'\t'`, `'\n'`, `'\v'`, `'\f'`, `'\r'`). If you need more control over *tokens* use `stm_read_token`. The pointer returned is temporary and will be overwritten on the next read. If necessary, make a copy with `str_c`. The input text encoding can be adjusted with `stm_set_read_utf`. It will update the row and column counter. See `stm_col`.

stm_read_token

Get the following token in “*Text stream*” (page 206).

```
token_t
stm_read_token(Stream *stm);
```

stm The stream.

Return:

The type of token obtained.

Remarks:

To get the text string associated with the token, use `stm_token_lexeme`. See “*Tokens*” (page 207).

stm_read_i8_tok

Read the following token with `stm_read_token` and, if it is an integer, convert it to `int8_t`.

```
int8_t
stm_read_i8_tok(Stream *stm);
```

stm The stream.

Return:

The numeric value of the token.

Remarks:

In case a token of type `ekTINTEGER` cannot be read (with or without `ekTMINUS`) or the numeric value is out of range, 0 will be returned and the stream will be marked as corrupt with `stm_corrupt`.

stm_read_i16_tok

Read the next token and convert it to `int16_t`.

```
int16_t
stm_read_i16_tok(Stream *stm);
```

stm The stream.

Return:

The numeric value of the token.

Remarks:

See `stm_read_i8_tok`.

stm_read_i32_tok

Read the next token and convert it to `int32_t`.

```
int32_t
stm_read_i32_tok(Stream *stm);
```

`stm` The stream.

Return:

The numeric value of the token.

Remarks:

See `stm_read_i8_tok`.

stm_read_i64_tok

Read the next token and convert it to `int64_t`.

```
int64_t
stm_read_i64_tok(Stream *stm);
```

`stm` The stream.

Return:

The numeric value of the token.

Remarks:

See `stm_read_i8_tok`.

stm_read_u8_tok

Read the following token with `stm_read_token` and, if it is an integer, convert it to `uint8_t`.

```
uint8_t
stm_read_u8_tok(Stream *stm);
```

`stm` The stream.

Return:

The numeric value of the token.

Remarks:

In case a token of type `ekTINTEGER` cannot be read or the numeric value is out of range, 0 will be returned and the stream will be marked as corrupt with `stm_corrupt`.

stm_read_u16_tok

Read the next token and convert it to `uint16_t`.

```
uint16_t
stm_read_u16_tok(Stream *stm);
```

`stm` The stream.

Return:

The numeric value of the token.

Remarks:

See `stm_read_u8_tok`.

stm_read_u32_tok

Read the next token and convert it to `uint32_t`.

```
uint32_t
stm_read_u32_tok(Stream *stm);
```

`stm` The stream.

Return:

The numeric value of the token.

Remarks:

See `stm_read_u8_tok`.

stm_read_u64_tok

Read the next token and convert it to `uint64_t`.

```
uint64_t
stm_read_u64_tok(Stream *stm);
```

`stm` The stream.

Return:

The numeric value of the token.

Remarks:

See `stm_read_u8_tok`.

stm_read_r32_tok

Read the following token with `stm_read_token` and, if it is a real number, convert it to `real32_t`.

```
real32_t
stm_read_r32_tok(Stream *stm);
```

`stm` The stream.

Return:

The numeric value of the token.

Remarks:

In case a token of type `ekTINTEGER` or `ekTREAL` cannot be read (with or without `ekTMINUS`), 0 will be returned and the stream will be marked as corrupt with `stm_corrupt`.

stm_read_r64_tok

Read the next token and convert it to `real64_t`.

```
real64_t
stm_read_r64_tok(Stream *stm);
```

`stm` The stream.

Return:

The numeric value of the token.

Remarks:

See `stm_read_r32_tok`.

stm_read_bool

Read a `bool_t` value from the stream.

```
bool_t  
stm_read_bool(Stream *stm);
```

`stm` The stream.

Return:

Value read.

Remarks:

It is a binary reading. Do not use in “pure” text streams.

stm_read_i8

Read a `int8_t` value from the stream.

```
int8_t  
stm_read_i8(Stream *stm);
```

`stm` The stream.

Return:

Value read.

Remarks:

It is a binary reading. Do not use in “pure” text streams.

stm_read_i16

Read a `int16_t` value from the stream.

```
int16_t  
stm_read_i16(Stream *stm);
```

`stm` The stream.

Return:

Value read.

Remarks:

It is a binary reading. Do not use in “pure” text streams. “*Byte order*” (page 213).

stm_read_i32

Read a `int32_t` value from the stream.

```
int32_t
stm_read_i32(Stream *stm);
```

`stm` The stream.

Return:

Value read.

Remarks:

It is a binary reading. Do not use in “pure” text streams. “*Byte order*” (page 213).

stm_read_i64

Read a `int64_t` value from the stream.

```
int64_t
stm_read_i64(Stream *stm);
```

`stm` The stream.

Return:

Value read.

Remarks:

It is a binary reading. Do not use in “pure” text streams. “*Byte order*” (page 213).

stm_read_u8

Read a `uint8_t` value from the stream.

```
uint8_t
stm_read_u8(Stream *stm);
```

stm The stream.

Return:

Value read.

Remarks:

It is a binary reading. Do not use in “pure” text streams.

stm_read_u16

Read a `uint16_t` value from the stream.

```
uint16_t  
stm_read_u16(Stream *stm);
```

stm The stream.

Return:

Value read.

Remarks:

It is a binary reading. Do not use in “pure” text streams. “*Byte order*” (page 213).

stm_read_u32

Read a `uint32_t` value from the stream.

```
uint32_t  
stm_read_u32(Stream *stm);
```

stm The stream.

Return:

Value read.

Remarks:

It is a binary reading. Do not use in “pure” text streams. “*Byte order*” (page 213).

stm_read_u64

Read a `uint64_t` value from the stream.

```
uint64_t  
stm_read_u64(Stream *stm);
```

stm The stream.

Return:

Value read.

Remarks:

It is a binary reading. Do not use in “pure” text streams. “*Byte order*” (page 213).

stm_read_r32

Read a `real32_t` value from the stream.

```
real32_t
stm_read_r32(Stream *stm);
```

stm The stream.

Return:

Value read.

Remarks:

It is a binary reading. Do not use in “pure” text streams. “*Byte order*” (page 213).

stm_read_r64

Read a `real64_t` value from the stream.

```
real64_t
stm_read_r64(Stream *stm);
```

stm The stream.

Return:

Value read.

Remarks:

It is a binary reading. Do not use in “pure” text streams. “*Byte order*” (page 213).

stm_read_enum

Read a `enum` value from the stream.

```
type
stm_read_enum(Stream *stm,
              type);
```

stm The stream.

type The `enum` type.

Return:

Value read.

Remarks:

It is a binary reading. Do not use in “pure” text streams. “*Byte order*” (page 213).

stm_skip

Skip and ignore the next bytes of the stream.

```
void
stm_skip(Stream *stm,
         const uint32_t size);
```

stm The stream.

size The number of bytes to skip.

stm_skip_bom

Skip the possible *Byte Order Mark* sequence “`ï»¿`” found at the beginning of some text streams.

```
void
stm_skip_bom(Stream *stm);
```

stm The stream.

Remarks:

This function will have no effect if there is no such sequence at the beginning of the stream. The BOM is common in streams coming from some web servers.

stm_skip_token

Skip the next token in the stream. If the token does not correspond to the one indicated, the stream will be marked as corrupt.

```
void
stm_skip_token(Stream *stm,
               const token_t token);
```

```
void stm_skip_token(Stream *stm, const token_t token)
{
    token_t tok = stm_read_token(stm);
    if (tok != token)
        stm_corrupt(stm);
}
```

stm The stream.

token Expected token.

stm_flush

Write in the channel the existing information in the cache.

```
void
stm_flush(Stream *stm);
```

stm The stream.

Remarks:

To improve performance, write operations on disk streams or standard I/O are stored in an internal cache. This function forces writing on the channel and cleans the buffer. It will be useful with *full-duplex* protocols where the receiver awaits reply to continue.

stm_pipe

Connect two streams, reading data from one and writing it to another.

```
void
stm_pipe(Stream *from,
         Stream *to,
         const uint32_t n);
```

from The input stream (to read).

to The output stream (to write).

n The number of bytes to be transferred.

Remarks:

The transfer will be made on raw data, regardless of “*Byte order*” (page 213) or “*UTF encodings*” (page 163). If you are clear that this does not affect, it is much faster than using atomic read/write operations.

stm_lines

Iterate over all lines in a “Text stream” (page 206). You should use `stm_next` to close the loop.

```
void
stm_lines(const char_t *line,
          Stream *stm);
```

```
uint32_t i = 1;
Stream *stm = stm_from_file("/home/john/friends.txt", NULL);
stm_lines(line, stm)
    bstd_printf("Friend %d, name %s\n", i++, line);
stm_next(line, stm)
stm_close(&stm);
```

- line Name of the variable that will temporarily host the line. Use an internal stream cache, so you should make a copy with `str_c` if you need to keep it.
- stm The stream.

stm_next

Close a loop open by `stm_lines`.

```
void
stm_next(const char_t *line,
         Stream *stm);
```

- line Name of the line variable.
- stm The stream.

arrst_create

Create an empty array.

```
ArrSt(type)*
arrst_create(type);
```

- type Object type.

Return:

The new array.

arrst_copy

Create a copy of an array.

```
ArrSt(type) *
arrst_copy(const ArrSt(type) *array,
           FPtr_scopy func_copy,
           type);
```

array The original array.

func_copy Function that must copy the fields of each object.

type Object type.

Return:

The copy of the original array.

Remarks:

The copy function must allocate memory to the fields that require it, but NOT to the object itself. If we pass `NULL`, a byte-by-byte copy of the original object will be made, which may pose an integrity risk if the array elements contain `String` or other objects that need dynamic memory.

arrst_read

Create an array by reading its contents from a “Streams” (page 201) (de-serialization).

```
ArrSt(type) *
arrst_read(Stream *stream,
           FPtr_read_init func_read,
           type);
```

stream A read *stream*.

func_read Function to initialize an object from the data obtained from a stream. This function should not reserve memory for the object itself (the container already does). “*Serialization*” (page 221).

type Object type.

Return:

The array readed.

arrst_destroy

Destroy an array and all its elements.

```
void
arrst_destroy(ArrSt(type) **array,
              FPtr_remove func_remove,
              type);
```

array The array. It will be set to `NULL` after destruction.

func_remove Function that must free the memory associated with the object's fields, but not the object itself “*Destructors*” (page 222). If `NULL` only the array will be destroyed and not the internal content of the elements.

type Object type.

arrst_destopt

Destroy an array and all its elements, as long as the array object is not `NULL`.

```
void
arrst_destopt(ArrSt(type) **array,
              FPtr_remove func_remove,
              type);
```

array The array.

func_remove See `arrst_destroy`.

type Object type.

arrst_clear

Delete the contents of the array, without destroying the container that will be left with zero elements.

```
void
arrst_clear(ArrSt(type) *array,
            FPtr_remove func_remove,
            type);
```

array The array.

func_remove Remove function. See `arrst_destroy`.

type Object type.

arrst_write

Write an array in a “*Streams*” (page 201) (serialization).

```

void
arrst_write(Stream *stream,
            const ArrSt(type) *array,
            FPtr_write func_write,
            type);

```

stream A write *stream*.

array The array.

func_write Function that writes the content of an element in a stream “*Serialization*” (page 221).

type Object type.

arrst_size

Get the number of elements in an array.

```

uint32_t
arrst_size(const ArrSt(type) *array,
           type);

```

array The array.

type Object type.

Return:

Number of elements.

arrst_get

Get a pointer to the item in pos position.

```

type*
arrst_get(ArrSt(type) *array,
          const uint32_t pos,
          type);

```

array The array.

pos Item position or index.

type Object type.

Return:

Item Pointer.

arrst_get_const

Get a **const** pointer to the item in pos position.

```

const type*
arrst_get_const(const ArrSt(type) *array,
               const uint32_t pos,
               type);

```

array The array.
 pos Item position or index.
 type Object type.

Return:

Item Pointer.

arrst_first

Gets a pointer to the first element of the array.

```

type*
arrst_first(ArrSt(type) *array,
            type);

```

array The array.
 type Object type.

Return:

Item pointer.

arrst_first_const

Gets a **const** pointer to the first element of the array.

```

const type*
arrst_first_const(const ArrSt(type) *array,
                 type);

```

array The array.
 type Object type.

Return:

Item pointer.

arrst_last

Get a pointer to the last element of the array.

```
type*
arrst_last (ArrSt(type) *array,
           type);
```

array The array.

type Object type.

Return:

Item Pointer.

arrst_last_const

Get a **const** pointer to the last element of the array.

```
const type*
arrst_last_const (const ArrSt(type) *array,
                 type);
```

array The array.

type Object type.

Return:

Item Pointer.

arrst_all

Get a pointer to the internal memory of the array, which gives direct access to all the elements.

```
type*
arrst_all (ArrSt(type) *array,
          type);
```

array The array.

type Object type.

Return:

Base pointer. Increasing it one by one we will iterate over the elements.

Remarks:

Use `arrst_foreach` to iterate over all elements in a more secure and elegant way.

arrst_all_const

Get a **const** pointer to the internal memory of the array, which gives direct access to all the elements.

```
const type*
arrst_all_const(const ArrSt(type) *array,
               type);
```

array The array.

type Object type.

Return:

Base pointer. Increasing it one by one we will iterate over the elements.

Remarks:

Use `arrst_foreach_const` to iterate over all elements in a more secure and elegant way.

arrst_grow

Add `n` elements, not initialized, at the end of the array.

```
void
arrst_grow(ArrSt(type) *array,
           const uint32_t n,
           type);
```

array The array.

n Number of items to add.

type Object type.

arrst_new

Reserve space for an element at the end of the array.

```
type*
arrst_new(ArrSt(type) *array,
          type);
```

```
// arrst_append copies 'product'
Product product;
i_init_product(&product, ...);
arrst_append(array, product, Product);
```

```
// arrst_new avoids the copy
Product *product = arrst_new(array, Product);
i_init_product(product, ...);
```

array The array.

type Object type.

Return:

Pointer to added element.

Remarks:

It is slightly faster than `arrst_append`, especially in large structures, since it avoids copying the contents of the object. Initial memory content is indeterminate.

arrst_new0

Reserve space for an element at the end of the array and initialize it to 0.

```
type*
arrst_new0(ArrSt(type) *array,
           type);
```

array The array.

type Object type.

Return:

Pointer to added element.

Remarks:

Same as `arrst_new` but initializing all memory to 0.

arrst_new_n

Reserve space for multiple elements at the end of the array.

```
type*
arrst_new_n(ArrSt(type) *array,
            const uint32_t n,
            type);
```

array The array.

n Number of elements to add.

type Object type.

Return:

Pointer to the first element added.

Remarks:

Same as `arrst_new` but reserving multiple elements in the same call. Initial memory content is indeterminate.

arrst_new_n0

Reserve space for several elements at the end of the array and initialize them to 0.

```
type*
arrst_new_n0(ArrSt(type) *array,
             const uint32_t n,
             type);
```

`array` The array.

`n` Number of elements to add.

`type` Object type.

Return:

Pointer to the first element added.

Remarks:

Same as `arrst_new_n` but initializing all memory to 0.

arrst_prepend_n

Reserve space for several elements at the beginning of the array. The rest of the elements will be shifted to the right.

```
type*
arrst_prepend_n(ArrSt(type) *array,
                const uint32_t n,
                type);
```

`array` The array.

`n` Number of elements to insert.

`type` Object type.

Return:

Pointer to the first inserted element.

Remarks:

Initial memory content is indeterminate.

arrst_insert_n

Reserve space for several elements in an arbitrary position of the array.

```
type*
arrst_insert_n(ArrSt(type) *array,
               const uint32_t pos,
               const uint32_t n,
               type);
```

array The array.

pos Position where it will be inserted. The current element in `pos` and following will be shifted to the right.

n Number of elements to insert.

type Object type.

Return:

Pointer to the first inserted element.

Remarks:

Initial memory content is indeterminate.

arrst_append

Append an element to the end of the array.

```
void
arrst_append(ArrSt(type) *array,
             type value,
             type);
```

array The array.

value Item to add.

type Object type.

arrst_prepend

Insert an element at the beginning of the array. The rest of the elements will be shifted to the right.

```
void
arrst_prepend(ArrSt(type) *array,
              type value,
              type);
```

array The array.

value Item to insert.

type Object type.

arrst_insert

Insert an element in an arbitrary array position.

```
void
arrst_insert(ArrSt(type) *array,
             const uint32_t pos,
             type value,
             type);
```

array The array.

pos Position where it will be inserted. The current item in `pos` and following will be shifted to the right.

value Item to insert.

type Object type.

arrst_join

Join two vectors. Add all the elements of `src` to the end of `dest`.

```
void
arrst_join(ArrSt(type) *dest,
           const ArrSt(type) *src,
           FPtr_scopy func_copy,
           type);
```

```
ArrSt(Product) *products = create_products(...);
ArrSt(Product) *new_products = new_products(...);
```

```
// Join without 'copy' func. Dynamic 'Product' fields will be reused.
```

```
arrst_join(products, new_products, NULL, Product);
```

```
arrst_destroy(&new_products, NULL, Product);
```

```
...
```

```
arrst_destroy(&products, i_remove, Product);
```

```
// Join with 'copy' func. Dynamic 'Product' fields will be duplicate.
```

```

arrst_join(products, new_products, i_copy_data, Product);
arrst_destroy(&new_products, i_remove, Product);
...
arrst_destroy(&products, i_remove, Product);

```

dest The destination array.
src The array whose elements will be added to **dest**.
func_copy Object copy function.
type Object type.

Remarks:

The copy function must create dynamic memory for the fields that require it, but NOT for the object itself. See `arrst_copy`. If it is `NULL`, a byte-by-byte copy of the element will be made.

arrst_delete

Remove an element from the array.

```

void
arrst_delete(ArrSt(type) *array,
             const uint32_t pos,
             FPtr_remove func_remove,
             type);

```

array The array.
pos Position of the item to be deleted. The current item in `pos+1` and following will be shifted to the left.
func_remove 'Remove' function. See `arrst_destroy`.
type Object type.

arrst_pop

Remove the last element from the array.

```

void
arrst_pop(ArrSt(type) *array,
          FPtr_remove func_remove,
          type);

```

array The array.
func_remove 'Remove' function. See `arrst_destroy`.
type Object type.

arrst_sort

Sort array elements using Quicksort.

```
void
arrst_sort(ArrSt(type) *array,
           FPtr_compare func_compare,
           type);
```

array The array.

func_compare Function to compare two elements. “Sort and search” (page 223).

type Object type.

arrst_sort_ex

Sort array elements using Quicksort and additional data.

```
void
arrst_sort_ex(ArrSt(type) *array,
              FPtr_compare_ex func_compare,
              type,
              dtype);
```

array The array.

func_compare Function to compare two elements using an additional data.

type Object type.

dtype Type of data in the comparison function.

arrst_search

Search for an element in the array linearly $O(n)$.

```
type*
arrst_search(ArrSt(type) *array,
             FPtr_compare func_compare,
             const ktype *key,
             uint32_t *pos,
             type,
             ktype);
```

```
uint32_t pos;
uint32_t key = 345;
Product *product = arrst_search(arrst, i_compare_key, &key, &pos, Product,
                               ↪ uint32_t);
```

array	The array.
func_compare	Comparison function. The first parameter is the element, the second the search key. “ <i>Sort and search</i> ” (page 223).
key	Search key. Pointer to a data type that may be different from the type of array element.
pos	Position of the element in the array (if it exists), or <code>UINT32_MAX</code> if it does not exist. Can be <code>NULL</code> .
type	Object type.
ktype	Key type.

Return:

Pointer to the first element that matches the search criteria or `NULL` if none exists.

arrst_search_const

Const version of `arrst_search`.

```
const type*
arrst_search_const(const ArrSt(type) *array,
                  FPtr_compare func_compare,
                  const ktype *key,
                  uint32_t *pos,
                  type,
                  ktype);
```

array	The array.
func_compare	Comparison function.
key	Search key.
pos	Position of the element in the array.
type	Object type.
ktype	Key type.

Return:

Pointer to element.

arrst_bsearch

Search for an element in the array logarithmically $O(\log n)$.

```

type*
arrst_bsearch(ArrSt(type) *array,
              FPtr_compare func_compare,
              const ktype *key,
              uint32_t *pos,
              type,
              ktype);

```

array The array.

func_compare Comparison function. The first parameter is the element, the second the search key. “*Sort and search*” (page 223).

key Search key. Pointer to a data type that may be different from the type of array element.

pos Position of the element in the array (if it exists), or `UINT32_MAX` if it does not exist. Can be `NULL`.

type Object type.

ktype Key type.

Return:

Pointer to the first element that matches the search criteria or `NULL` if none exists.

Remarks:

The array must be sorted according to the same criteria as the search. If not, the result is unpredictable.

arrst_bsearch_const

Const version of `arrst_bsearch`.

```

const type*
arrst_bsearch_const(const ArrSt(type) *array,
                   FPtr_compare func_compare,
                   const ktype *key,
                   uint32_t *pos,
                   type,
                   ktype);

```

array	The array.
func_compare	Comparison function.
key	Search key.
pos	Element position in array.
type	Object type.
ktype	Key type.

Return:

Pointer to element.

arrst_foreach

Iterate on all array elements. Uses `arrst_end` to close the loop.

```
void
arrst_foreach(type *elem,
              ArrSt(type) *array,
              type);
```

```
arrst_foreach(product, array, Product)
    bstd_printf("Index:%d, Id:%d\n", product_i, product->id);
arrst_end()
```

elem	Name of the 'element' variable within the loop. Adding the suffix '_i' we get the index.
array	The array.
type	Object type.

arrst_foreach_const

Const version of `arrst_foreach`.

```
void
arrst_foreach_const(const type *elem,
                   const ArrSt(type) *array,
                   type);
```

elem	Element.
array	The array.
type	Object type.

arrst_forback

Iterate on all array elements backward, from the last to the first. Uses `arrst_end` to close the loop.

```
void
arrst_forback(type *elem,
              ArrSt(type) *array,
              type);
```

```
// Now in reverse order
arrst_forback(product, array, Product)
    bstd_printf("Index:%d, Id:%d\n", product_i, product->id);
arrst_end()
```

- elem Name of the 'element' variable within the loop. Adding the suffix '_i' we get the index.
- array The array.
- type Object type.

arrst_forback_const

Const version of `arrst_forback`.

```
void
arrst_forback_const(const type *elem,
                   const ArrSt(type) *array,
                   type);
```

- elem Element.
- array The array.
- type Object type.

arrst_end

Close the loop opened by `arrst_foreach`, `arrst_foreach_const`, `arrst_forback` or `arrst_forback_const`.

```
void
arrst_end(void);
```

arrpt_create

Create an empty array of pointers.

```
ArrPt(type)*
arrpt_create(type);
```

type Object type.

Return:

The new array.

arrpt_copy

Create a copy of an array of pointers.

```
ArrPt(type)*
arrpt_copy(const ArrPt(type) *array,
           FPtr_copy func_copy,
           type);
```

array The original array.

func_copy Object copy function.

type Object type.

Return:

The copy of the original array.

Remarks:

The copy function must create a dynamic object and allocate memory for internal fields that require it. If we pass `NULL`, a copy of the original pointers will be made, which can pose an integrity risk since the same object can be destroyed twice if we are not careful. See “*Copy objects*” (page 220).

arrpt_read

Create an array by reading its contents from a “*Streams*” (page 201) (de-serialization).

```
ArrPt(type)*
arrpt_read(Stream *stream,
           FPtr_read func_read,
           type);
```

stream A read *stream*.

func_read Constructor to create an object from the data obtained from a stream. “*Serialization*” (page 221).

type Object type.

Return:

The array readed.

arrpt_destroy

Destroy an array and all its elements.

```
void
arrpt_destroy(ArrPt(type) **array,
              FPtr_destroy func_destroy,
              type);
```

array The array. It will be set to `NULL` after destruction.

func_destroy Function to destroy an element “*Destructors*” (page 222). If `NULL` only the array will be destroyed, but not its elements.

type Object type.

arrpt_destopt

Destroy an array and all its elements, as long as the array object is not `NULL`.

```
void
arrpt_destopt(ArrSt(type) **array,
              FPtr_destroy func_destroy,
              type);
```

array The array.

func_destroy See `arrpt_destroy`.

type Object type.

arrpt_clear

Delete the contents of the array, without destroying the container that will be left with zero elements.

```
void
arrpt_clear(ArrPt(type) *array,
            FPtr_destroy func_destroy,
            type);
```

array The array.
 func_destroy Destructor function. See `arrpt_destroy`.
 type Object type.

arrpt_write

Write an array in a “Streams” (page 201) (serialization).

```
void
arrpt_write(Stream *stream,
            const ArrPt(type) *array,
            FPtr_write func_write,
            type);
```

stream A write *stream*.
 array The array.
 func_write Function that writes the content of an element in a stream “*Serializa-
 tion*” (page 221).
 type Object type.

arrpt_size

Get the number of elements in an array.

```
uint32_t
arrpt_size(const ArrPt(type) *array,
           type);
```

array The array.
 type Object type.

Return:

Number of elements.

arrpt_get

Get a pointer to the item in `pos` position.

```
type*
arrpt_get(ArrPt(type) *array,
          const uint32_t pos,
          type);
```

array The array.
 pos Item position or index.
 type Object type.

Return:

Item Pointer.

arrpt_get_const

Get a **const** pointer to the item in pos position.

```
const type*
arrpt_get_const(const ArrPt(type) *array,
               const uint32_t pos,
               type);
```

array The array.
 pos Item position or index.
 type Object type.

Return:

Item Pointer.

arrpt_first

Get a pointer to the first element of the array.

```
type*
arrpt_first(ArrPt(type) *array,
            type);
```

array The array.
 type Object type.

Return:

Item Pointer.

arrpt_first_const

Get a **const** pointer to the first element of the array.

```
const type*
arrpt_first_const(const ArrPt(type) *array,
                 type);
```

array The array.
 type Object type.

Return:

Item Pointer.

arrpt_last

Get a pointer to the last element of the array.

```
type*
arrpt_last (ArrPt (type) *array,
           type);
```

array The array.
 type Object type.

Return:

Item Pointer.

arrpt_last_const

Get a **const** pointer to the last element of the array.

```
const type*
arrpt_last_const (const ArrPt (type) *array,
                 type);
```

array The array.
 type Object type.

Return:

Item Pointer.

arrpt_all

Get a pointer to the internal memory of the array, which gives access to all the elements.

```
type**
arrpt_all (ArrPt (type) *array,
          type);
```

array The array.
 type Object type.

Return:

Base pointer. Increasing it one by one we will iterate over the elements.

Remarks:

Use `arrpt_foreach` to iterate over all elements in a more secure and elegant way.

arrpt_all_const

Get a **const** pointer to the internal memory of the array, which gives access to all the elements.

```
const type**
arrpt_all_const(const ArrPt(type) *array,
               type);
```

array The array.

type Object type.

Return:

Base pointer. Increasing it one by one we will iterate over the elements.

Remarks:

Use `arrpt_foreach_const` to iterate over all elements in a more secure and elegant way.

arrpt_grow

Append `n` elements, not initialized, at the end of the array.

```
type**
arrpt_grow(ArrPt(type) *array,
           const uint32_t n,
           type);
```

array The array.

n Number of items to add.

type Object type.

Return:

Pointer to the first item added.

arrpt_append

Adds a pointer to the end of the array.

```
void
arrpt_append(ArrPt(type) *array,
             type *value,
             type);
```

- array The array.
- value Pointer to the item to append.
- type Object type.

arrpt_prepend

Insert a pointer at the beginning of the array. The rest of the elements will be shifted to the right.

```
void
arrpt_prepend(ArrPt(type) *array,
              type *value,
              type);
```

- array The array.
- value Pointer to the element to insert.
- type Object type.

arrpt_insert

Insert a pointer in an arbitrary array position.

```
void
arrpt_insert(ArrPt(type) *array,
             const uint32_t pos,
             type *value,
             type);
```

- array The array.
- pos Position where it will be inserted. The current item in `pos` and following will be shifted to the right.
- value Pointer to the element to insert.
- type Object type.

arrpt_insert_n

Inserts several pointers at an arbitrary position in the array.

```

type**
arrpt_insert_n(ArrPt(type) *array,
               const uint32_t pos,
               const uint32_t n,
               type);

```

array The array.

pos Position where the first element will be inserted. The current element in pos and following will be shifted to the right.

n Number of elements to insert.

type Object type.

Return:

Pointer to the first inserted pointer.

Remarks:

The initial content of the memory is indeterminate.

arrpt_join

Join two vectors. Add all the elements of src to the end of dest.

```

void
arrpt_join(ArrPt(type) *dest,
           const ArrPt(type) *src,
           FPtr_copy func_copy,
           type);

```

```

ArrPt(Product) *products = create_products(...);
ArrPt(Product) *new_products = new_products(...);

// Join without 'copy' func. Dynamic 'Product' objects will be reused.
arrpt_join(products, new_products, NULL, Product);
arrpt_destroy(&new_products, NULL, Product);
...
arrpt_destroy(&products, i_destroy, Product);

// Join with 'copy' func. Dynamic 'Product' objects will be duplicate.
arrpt_join(products, new_products, i_copy, Product);
arrpt_destroy(&new_products, i_destroy, Product);
...
arrpt_destroy(&products, i_destroy, Product);

```

dest The destination array.
 src The array whose elements will be added to dest.
 func_copy Object copy function.
 type Object type.

Remarks:

The copy function must create dynamic memory for both the object and the fields that require it. If it is `NULL` it will only add a copy of the original pointer to dest.

arrpt_delete

Remove a pointer from the array.

```
void
arrpt_delete(ArrPt(type) *array,
             const uint32_t pos,
             FPtr_destroy func_destroy,
             type);
```

array The array.
 pos Position of the item to be deleted. The current item in pos+1 and following will be shifted to the left.
 func_destroy Element destructor. See `arrpt_destroy`.
 type Object type.

arrpt_pop

Remove the last pointer from the array.

```
void
arrpt_pop(ArrPt(type) *array,
          FPtr_destroy func_destroy,
          type);
```

array The array.
 func_destroy Element destructor. See `arrpt_destroy`.
 type Object type.

arrpt_sort

Sort the array elements using Quicksort.

```
void
arrpt_sort(ArrPt(type) *array,
           FPtr_compare func_compare,
           type);
```

array The array.

func_compare Function to compare two elements. “*Sort and search*” (page 223).

type Object type.

arrpt_sort_ex

Sort array elements using Quicksort and additional data.

```
void
arrpt_sort_ex(ArrPt(type) *array,
              FPtr_compare_ex func_compare,
              type,
              dtype);
```

array The array.

func_compare Function to compare two elements using an additional data.

type Object type.

dtype Type of data in the comparison function.

arrpt_find

Search for a specific pointer in the array.

```
uint32_t
arrpt_find(const ArrPt(type) *array,
           type *elem,
           type);
```

array The array.

elem Pointer to find.

type Object type.

Return:

The position of the pointer if it exists, or `UINT32_MAX` if not.

arrpt_search

Search for an element in the array linearly $O(n)$.

```
type*
arrpt_search(ArrPt(type) *array,
             FPtr_compare func_compare,
             ktype key,
             uint32_t *pos,
             type,
             ktype);
```

array The array.

func_compare Comparison function. The first parameter is the element, the second the search key. “Sort and search” (page 223).

key Search key. Pointer to a data type that may be different from the type of array element.

pos Position of the element in the array (if it exists), or `UINT32_MAX` if it does not exist. Can be `NULL`.

type Object type.

ktype Key type.

Return:

Pointer to the first element that matches the search criteria or `NULL` if none exists.

arrpt_search_const

Const version of `arrpt_search`.

```
const type*
arrpt_search_const(const ArrPt(type) *array,
                  FPtr_compare func_compare,
                  const ktype *key,
                  uint32_t *pos,
                  type,
                  ktype);
```

array	The array.
func_compare	Comparison function.
key	Search key.
pos	Position of the element in the array.
type	Object type.
ktype	Key type.

Return:

Element.

arrpt_bsearch

Search for an element in the array logarithmically $O(\log n)$.

```

type*
arrpt_bsearch(ArrPt(type) *array,
              FPtr_compare func_compare,
              ktype key,
              uint32_t *pos,
              type,
              ktype);

```

array	The array.
func_compare	Comparison function. The first parameter is the element, the second the search key. “Sort and search” (page 223).
key	Key to search. Pointer to a data type that can be different from the element type of the array.
pos	Position of the element in the array (if it exists), or <code>UINT32_MAX</code> if it does not exist. Can be <code>NULL</code> .
type	Object type.
ktype	Key type.

Return:

Pointer to the first element that matches the search criteria or `NULL` if none exists.

Remarks:

The array must be sorted according to the same criteria as the search. If not, the result is unpredictable.

arrpt_bsearch_const

Const version of `arrpt_bsearch`.

```
const type*
arrpt_bsearch_const(const ArrPt(type) *array,
                  FPtr_compare func_compare,
                  const ktype *key,
                  uint32_t *pos,
                  type,
                  ktype);
```

array The array.

func_compare Comparison function.

key Search key.

pos Position of the element in the array.

type Object type.

ktype Key type.

Return:

Element.

arrpt_foreach

Iterate on all array elements. Uses `arrpt_end` to close the loop.

```
void
arrpt_foreach(type *elem,
              ArrPt(type) *array,
              type);
```

```
arrpt_foreach(product, array, Product)
    bstd_printf("Index:%d, Id:%d\n", product_i, product->id);
arrpt_end()
```

elem Name of the 'element' variable within the loop. Adding the suffix '_i' we get the index.

array The array.

type Object type.

arrpt_foreach_const

Const version of `arrpt_foreach`.

```
void
arrpt_foreach_const(const type *elem,
                   const ArrPt(type) *array,
                   type);
```

elem Element.
array The array.
type Object type.

arrpt_forback

Iterate on all array elements backward, from the last to the first. Uses `arrpt_end` to close the loop.

```
void
arrpt_forback(type *elem,
              ArrPt(type) *array,
              type);
```

```
// Now in reverse order
arrpt_forback(product, array, Product)
    bstd_printf("Index:%d, Id:%d\n", product_i, product->id);
arrpt_end()
```

elem Name of the 'element' variable within the loop. Adding the suffix '`_i`' we get the index.
array The array.
type Object type.

arrpt_forback_const

Const version of `arrpt_forback`.

```
void
arrpt_forback_const(const type *elem,
                   const ArrPt(type) *array,
                   type);
```

elem Element.
array The array.
type Object type.

arrpt_end

Close the loop opened by `arrpt_foreach`, `arrpt_foreach_const`, `arrpt_forback` or `arrpt_forback_const`.

```
void
arrpt_end(void);
```

setst_create

Create an empty set of registers.

```
SetSt(type)*
setst_create(FPtr_compare func_compare,
            type);
```

`func_compare` Function to compare two elements. “*Sort and search*” (page 223).

`type` Object type.

Return:

The new set.

setst_destroy

Destroy a set and all its elements.

```
void
setst_destroy(SetSt(type) **set,
             FPtr_remove func_remove,
             type);
```

`set` The set. Will be set to `NULL` after destruction.

`func_remove` Function that must free the memory associated with the object’s fields, but not the object itself “*Destructors*” (page 222). If it is `NULL` only the set will be released and not the internal content of the elements.

`type` Object type.

setst_size

Get the number of set elements.

```
uint32_t
setst_size(const SetSt(type) *set,
           type);
```

set The set.

type Object type.

Return:

Number of items.

setst_get

Search for an item in $O(\log n)$. It is equivalent to `arrst_bsearch`. If exists, the internal structure iterator will be fixed in it.

```
type*
setst_get(SetSt(type) *set,
          const type *key,
          type);
```

```
Product key;
Product *pr;
key.id = 453;
pr = setst_get(setst, &key, Product);
```

set The set.

key Search key. It is a pointer to an object where only the relevant search fields must be initialized.

type Object type.

Return:

Pointer to the item if it exists, or `NULL` if not.

Remarks:

“Iterators” (page 227).

setst_get_const

Const version of `setst_get`.

```
const type*
setst_get_const(const SetSt(type) *set,
               const type *key,
               type);
```

set The set.
 key Search key.
 type Object type.

Return:

Element.

setst_insert

Insert a new item in the set.

```
type*
setst_insert(SetSt(type) *set,
             type *key,
             type);
```

```
Product *pr;
Product key;
key.id = 345;
pr = setst_insert(setst, &key, Product);
if (pr != NULL)
    i_init(pr, 345, 100.45f);
else
    error("Already exists");
```

set The set.
 key Key to insert. It is a pointer to an object where only the relevant search fields must be initialized.
 type Object type.

Return:

Pointer to the inserted element, which should be used to initialize the object. If an item with the same key already exists, it returns `NULL`.

Remarks:

Inserting or deleting elements invalidates the internal set iterator “*Iterators*” (page 227). You must re-initialize it with `setst_first`.

setst_delete

Remove an item from the set.

```
bool_t
setst_delete(SetSt(type) *set,
             type *key,
             FPtr_remove func_remove,
             type);
```

```
Product key;
key.id = 345;
if (setst_delete(setst, &key, product_remove, Product) == FALSE)
    error("Doesn't exists");
```

set The set.

key Key to delete. It is a pointer to an object where only the relevant search fields must be initialized.

func_remove Remove function. See `setst_destroy`.

type Object type.

Return:

`TRUE` if the item has been deleted, or `FALSE` if there is no item with that key.

Remarks:

Inserting or deleting elements invalidates the internal set iterator “*Iterators*” (page 227). You must re-initialize it with `setst_first`.

setst_first

Get the first set element and initialize the internal iterator.

```
type*
setst_first(SetSt(type) *set,
            type);
```

set The set.

type Object type.

Return:

Pointer to the first element or `NULL` if the set is empty.

Remarks:

“*Iterators*” (page 227).

setst_first_const

Const version of `setst_first`.

```
const type*
setst_first_const(const SetSt(type) *set,
                 type);
```

set The set.

type Object type.

Return:

Element.

setst_last

Get the last element of the set and initialize the internal iterator.

```
type*
setst_last(SetSt(type) *set,
           type);
```

set The set.

type Object type.

Return:

Pointer to the last item or `NULL` if the set is empty.

Remarks:

“Iterators” (page 227).

setst_last_const

Const version of `setst_last`.

```
const type*
setst_last_const(const SetSt(type) *set,
                 type);
```

set The set.

type Object type.

Return:

Element.

setst_next

Get the next set item, after increasing the internal iterator.

```

type*
setst_next(SetSt(type) *set,
           type);

```

set The set.

type Object type.

Return:

Pointer to the next item or **NULL** if the iterator has reached the last.

Remarks:

Use `setst_first` to initialize the internal iterator “*Iterators*” (page 227).

setst_next_const

Const version of `setst_next`.

```

const type*
setst_next_const(const SetSt(type) *set,
                type);

```

set The set.

type Object type.

Return:

Element.

setst_prev

Gets the previous element of the set, after decrementing the internal iterator.

```

type*
setst_prev(SetSt(type) *set,
           type);

```

set The set.

type Object type.

Return:

Pointer to the previous item or **NULL** if the iterator has reached the first.

Remarks:

Use `setst_last` to initialize the internal iterator on reversed loops “Iterators” (page 227).

setst_prev_const

Const version of `setst_prev`.

```
const type*
setst_prev_const(const SetSt(type) *set,
                type);
```

set The set.

type Object type.

Return:

Element.

setst_foreach

Go through all the elements of the set. Use `setst_fornext` to close the loop.

```
void
setst_foreach(type *elem,
              SetSt(type) *set,
              type);
```

```
setst_foreach(product, set, Product)
    bstd_printf("Position:%d, Id:%d\n", product_i, product->id);
setst_fornext(product, set, Product)
```

elem Name of the variable 'element' within the loop. Adding the suffix '`_i`' we get the index.

set The set.

type Object type.

setst_foreach_const

Const version of `setst_foreach`.

```
void
setst_foreach_const(const type *elem,
                   const SetSt(type) *set,
                   type);
```

elem Element.
 set The set.
 type Object type.

setst_fornext

Close the loop opened by `setst_foreach`, increasing the internal iterator.

```
void
setst_fornext(type *elem,
             SetSt(type) *set,
             type);
```

elem Name of the variable 'element'. It must be the same as `setst_foreach`.
 set The set.
 type Object type.

setst_fornext_const

Const version of `setst_fornext`.

```
void
setst_fornext_const(const type *elem,
                   const SetSt(type) *set,
                   type);
```

elem Element.
 set The set.
 type Object type.

setst_forback

Go through all the elements of the set in reverse order. Use `setst_forprev` to close the loop.

```
void
setst_forback(type *elem,
             SetSt(type) *set,
             type);
```

```
// Now in reverse order
setst_forback(product, set, Product)
  bstd_printf("Position:%d, Id:%d\n", product_i, product->id);
setst_forprev(product, set, Product)
```

elem Name of the variable 'element' within the loop. Adding the suffix '_i' we get the index.

set The set.

type Object type.

setst_forback_const

Const version of `setst_forback`.

```
void
setst_forback_const(const type *elem,
                   const SetSt(type) *set,
                   type);
```

elem Element.

set The set.

type Object type.

setst_forprev

Close the loop opened by `setst_forback`, decreasing the internal iterator.

```
void
setst_forprev(type *elem,
              SetSt(type) *set,
              type);
```

elem Name of the variable 'element'. It must be the same as `setst_foreach_rev`.

set The set.

type Object type.

setst_forprev_const

Const version of `setst_forprev`.

```
void
setst_forprev_const(const type *elem,
                   const SetSt(type) *set,
                   type);
```

elem Element.
 set The set.
 type Object type.

setpt_create

Create an empty pointer set.

```
SetPt(type) *
setpt_create(FPtr_compare func_compare,
             type);
```

func_compare Function to compare two elements. “*Sort and search*” (page 223).
 type Object type.

Return:

The new set.

setpt_destroy

Destroy a set and all its elements.

```
void
setpt_destroy(SetPt(type) **set,
              FPtr_destroy func_destroy,
              type);
```

set The set. Will be set to **NULL** after destruction.
 func_destroy Function to destroy an element of the set “*Destructors*” (page 222). If it is **NULL** only the set will be destroyed, but not its elements.
 type Object type.

setpt_size

Get the number of set elements.

```
uint32_t
setpt_size(const SetPt(type) *set,
           type);
```

set The set.
 type Object type.

Return:

Number of items.

setpt_get

Search for an item in $O(\log n)$. It is equivalent to `arrpt_bsearch`. The internal set iterator will be fixed in it.

```
type*
setpt_get(SetPt(type) *set,
         type *key,
         type);
```

```
Product key;
Product *pr;
key.id = 453;
pr = setpt_get(setpt, &key, Product);
```

set The set.

key Search key. It is a pointer to an object where only the relevant fields of the search must be initialized.

type Object type.

Return:

Pointer to the searched item if it exists, or `NULL` if not.

Remarks:

“Iterators” (page 227).

setpt_get_const

Const version of `setpt_get`.

```
const type*
setpt_get_const(const SetPt(type) *set,
              const type *key,
              type);
```

set The set.

key Search key.

type Object type.

Return:

Element.

setpt_insert

Insert a new item in the set.

```
bool_t
setpt_insert(SetPt(type) *set,
             type *value,
             type);
```

```
Product *pr = product_create(...);
if (setpt_insert(setpt, pr, Product) == FALSE)
{
    error("Already exists");
    product_destroy(&pr);
}
```

set The set.

value Pointer to the element to insert.

type Object type.

Return:

TRUE if the item has been inserted. **FALSE** if another element with the same key already exists.

Remarks:

Inserting or deleting elements invalidates the internal set iterator “*Iterators*” (page 227). You must initialize it with `setpt_first`.

setpt_delete

Remove an item from the set.

```
bool_t
setpt_delete(SetPt(type) *set,
             type *key,
             FPtr_destroy func_destroy,
             type);
```

```
Product key;
key.id = 345;
if (setpt_delete(setpt, &key, product_destroy, Product) == FALSE)
    error("Doesn't exists");
```

set The set.
 key Key to delete. It is a pointer to an object where only the relevant fields of the search must be initialized.
 func_destroy Element destructor. Can be `NULL`. See `setpt_destroy`.
 type Object type.

Return:

`TRUE` if the item has been deleted, or `FALSE` if there is no item with that key.

Remarks:

Inserting or deleting elements invalidates the internal set iterator “*Iterators*” (page 227). You must initialize it with `setpt_first`.

setpt_first

Get the first element of the set and initialize the internal iterator.

```
type*
setpt_first(SetPt(type) *set,
            type);
```

set The set.
 type Object type.

Return:

Pointer to the first element or `NULL` if the set is empty.

Remarks:

“*Iterators*” (page 227).

setpt_first_const

Const version of `setpt_first`.

```
const type*
setpt_first_const(const SetPt(type) *set,
                 type);
```

set The set.
 type Object type.

Return:

Element.

setpt_last

Get the last element of the set and initialize the internal iterator.

```
type*
setpt_last(SetPt(type) *set,
           type);
```

set The set.

type Object type.

Return:

Pointer to the last item or `NULL` if the set is empty.

Remarks:

“Iterators” (page 227).

setpt_last_const

Const version of `setpt_last`.

```
const type*
setpt_last_const(const SetPt(type) *set,
                type);
```

set The set.

type Object type.

Return:

Element.

setpt_next

Get the next set item, after increasing the internal iterator.

```
type*
setpt_next(SetPt(type) *set,
           type);
```

set The set.

type Object type.

Return:

Pointer to the next item or `NULL` if the iterator has reached the last.

Remarks:

Use `setpt_first` to initialize the internal iterator “*Iterators*” (page 227).

setpt_next_const

Const version of `setpt_next`.

```
const type*
setpt_next_const(const SetPt(type) *set,
                type);
```

set The set.

type Object type.

Return:

Element.

setpt_prev

Gets the previous element of the set, after decrementing the internal iterator.

```
type*
setpt_prev(SetPt(type) *set,
           type);
```

set The set.

type Object type.

Return:

Pointer to the previous item or `NULL` if the iterator has reached the first.

Remarks:

Use `setpt_last` to initialize the internal iterator on reversed loops “*Iterators*” (page 227).

setpt_prev_const

Const version of `setpt_prev`.

```
const type*
setpt_prev_const(const SetPt(type) *set,
                type);
```

set The set.

type Object type.

Return:

Element.

setpt_foreach

Loop over all the elements of the set. Use `setpt_fornext` to close the loop.

```
void
setpt_foreach(type *elem,
              SetPt(type) *set,
              type);
```

```
setpt_foreach(product, set, Product)
    bstd_printf("Position:%d, Id:%d\n", product_i, product->id);
setpt_fornext(product, set, Product)
```

elem Name of the variable 'element' within the loop. Adding the suffix '_i' we get the index.

set The set.

type Object type.

setpt_foreach_const

Const version of `setpt_foreach`.

```
void
setpt_foreach_const(const type *elem,
                   const SetPt(type) *set,
                   type);
```

elem Element.

set The set.

type Object type.

setpt_fornext

Close the loop opened by `setpt_foreach`, increasing the internal iterator.

```
void
setpt_fornext(type *elem,
              SetPt(type) *set,
              type);
```

elem Name of the variable 'element'. It must be the same as `setpt_foreach`.
 set The set.
 type Object type.

setpt_fornext_const

Const version of `setpt_fornext`.

```
void
setpt_fornext_const(const type *elem,
                  const SetPt(type) *set,
                  type);
```

elem Element.
 set The set.
 type Object type.

setpt_forback

Loop over all the elements of the set in reverse order. Use `setpt_forprev` to close the loop.

```
void
setpt_forback(type *elem,
              SetPt(type) *set,
              type);
```

```
// Now in reverse order
setpt_forback(product, set, Product)
  bstd_printf("Position:%d, Id:%d\n", product_i, product->id);
setpt_forprev(product, set, Product)
```

elem Name of the variable 'element' within the loop. Adding the suffix '`_i`' we get the index.
 set The set.
 type Object type.

setpt_forback_const

Const version of `setpt_forback`.

```
void
setpt_forback_const(const type *elem,
                   const SetPt(type) *set,
```

```
type);
```

elem Element.

set The set.

type Object type.

setpt_forprev

Close the loop opened by `setpt_forback`, decreasing the internal iterator.

```
void
setpt_forprev(type *elem,
              SetPt(type) *set,
              type);
```

elem Name of the variable 'element'. It must be the same as `setpt_foreach_rev`.

set The set.

type Object type.

setpt_forprev_const

Const version of `setpt_forprev`.

```
void
setpt_forprev_const(const type *elem,
                   const SetPt(type) *set,
                   type);
```

elem Element.

set The set.

type Object type.

regex_create

Create a regular expression from a pattern.

```
Regex*
regex_create(const char_t *pattern);
```

pattern Search pattern.

Return:

Regular expression (automata).

Remarks:

See “*Define patterns*” (page 230).

regex_destroy

Destroy a regular expression.

```
void
regex_destroy(Regex **regex);
```

regex Regular expression. Will be set to `NULL` after destruction.

regex_match

Check if a string matches the search pattern.

```
bool_t
regex_match(const Regex *regex,
            const char_t *str);
```

regex Regular expression.

str String to evaluate.

Return:

`TRUE` if the string is accepted by the regular expression.

dbind

Adds a structure/class field to its internal table within dbind.

```
void
dbind(type,
      mtype,
      name);
```

type Type of structure or class.

mtype Type of field to register.

name Name of the field within the structure.

Remarks:

Errors will be generated at compile time if the indicated field does not belong to the structure. The method also works for classes in C++.

dbind_enum

Register an enum type value.

```
void
dbind_enum(type,
           value,
           const char_t *alias);
```

type Enum type.
value Value.
alias Alias para el valor.

Remarks:

`dbind_enum(mode_t, ekIMAGE_ANALISYS, "Image Analisis");` it will use the string “Image Analisis” instead of “ekIMAGE_ANALISYS” for those I/O or interface operations that require displaying the literals of the enumeration. For example, to populate the fields of a `PopUp` linked with a data field.

dbind_create

Create an object of registered type, initializing its fields with the default values.

```
type*
dbind_create(type);
```

type Object type.

Return:

Newly created object or `NULL` if `dbind` does not recognize the data type.

dbind_init

Initializes the fields of an object of a registered type with the default values.

```
void
dbind_init(type *obj,
           type);
```

obj Object whose memory has been reserved, but not initialized.
type Object type.

dbind_remove

Destroys the memory reserved by the fields of an object of registered type, but does not destroy the object itself.

```
void
dbind_remove(type *obj,
             type);
```

obj Object.

type Object type.

dbind_destroy

Destroy an object of registered type. The memory allocated to the fields and sub-objects will also be released recursively.

```
void
dbind_destroy(type **obj,
             type);
```

obj Object. Will be set to `NULL` after destruction.

type Object type.

dbind_destopt

Destructor optional. Like `dbind_destroy`, but accepting `NULL` values for the object.

```
void
dbind_destopt(type **obj,
             type);
```

obj Object to destroy.

type Object type.

dbind_read

Creates an object of a registered type from the data read from a stream.

```
type*
dbind_read(Stream *stm,
           type);
```

stm Reading stream.

type Object type to read.

Return:

Newly created object or `NULL` if there has been an error.

dbind_write

Write the content of an object of registered type in a write stream.

```
void  
dbind_write(Stream *stm,  
            const type *data,  
            type);
```

stm Writing stream.

data Object to write.

type Type of object to write.

dbind_default

Set the default value of a field.

```
void  
dbind_default(type,  
             mtype,  
             name,  
             mtype value);
```

type Type of structure or class.

mtype Field type.

name Name of the field within the structure.

value Default value as of now.

dbind_range

Set the maximum and minimum value in numeric fields.

```
void  
dbind_range(type,  
            mtype,  
            name,  
            mtype min,  
            mtype max);
```

type Type of structure or class.
 mtype Field type.
 name Name of the field within the structure.
 min Minimum value.
 max Maximum value.

Remarks:

It will fail if used in non-numeric fields.

dbind_precision

Set the jump between two consecutive numerical values.

```

void
dbind_precision(type,
                mtype,
                name,
                mtype prec);

```

type Type of structure or class.
 mtype Field type.
 name Name of the field within the structure.
 prec Accuracy (eg .05f in `real32_t` values).

Remarks:

It will fail if used in non-numeric fields.

dbind_increment

Sets the increment of a numerical value when clicking on a “*UpDown*” (page 324) control.

```

void
dbind_increment(type,
                mtype,
                name,
                mtype incr);

```

type Type of structure or class.
 mtype Field type.
 name Name of the field within the structure.
 incr Increase.

Remarks:

It will fail if used in non-numeric fields.

dbind_suffix

Set a suffix that will be added to the numerical value when converted to text.

```
void
dbind_suffix(type,
             mtype,
             name,
             const char_t *suffix);
```

type Type of structure or class.

mtype Field type.

name Name of the field within the structure.

suffix Suffix.

Remarks:

It will fail if used in non-numeric fields.

listener

Create a listener. This function will link an event sender with the receiver, usually the application controller. The sender object is responsible for destroying the listener.

```
Listener*
listener(type *obj,
         FPtr_event_handler func_event_handler,
         type);
```

obj Receiver object that will be passed as the first parameter to `func_event_handler`.

func_event_handler *Callback* function that will be called when the event occurs. Also known as *event handler*.

type The type of receiver object.

Return:

Listener object.

listen

Like `listener`, but used in C++ to define class *callbacks*. “Use of C++” (page 45).

```
void
listen(void);
```

listener_destroy

Destroy a listener.

```
void
listener_destroy(Listener **listener);
```

`listener` Listener. Will be set to `NULL` after destruction.

Remarks:

The sender is responsible for destroying the listener.

listener_update

Update the receiver and event handler. It is equivalent to destroying it, and creating it again.

```
void
listener_update(Listener **listener,
                Listener *new_listener);
```

`listener` The current listener.

`new_listener` The new listener.

Remarks:

This method must be used within the sender.

listener_event

Launches an event from the sender to the receiver.

```
void
listener_event(Listener *listener,
               const uint32_t type,
               sender_type *sender,
               params_type *params,
               result_type *result,
               sender_type,
               params_type,
               result_type);
```

listener List through which the event will be sent.
 type Event code.
 sender Event sender.
 params Event parameters, or `NULL` if it doesn't have.
 result Event result, or `NULL` if not expected.
 sender_type Type of sender object.
 params_type Type of params object, or `void` if it does not have.
 result_type Type of result object, or `void` if it does not have.

Remarks:

This method must be invoked within the event sender.

listener_pass_event

Pass the received event to another object, changing only the sender. Useful for not generating a new `Event` object.

```

void
listener_pass_event(Listener *list,
                   Event *event,
                   sender_type *sender,
                   sender_type);
  
```

list List through which the event will be resent.
 event Incoming event.
 sender The new event sender.
 sender_type Sender object type.

Remarks:

This method must be invoked within the event sender.

event_type

Get the event type.

```

uint32_t
event_type(const Event *event);
  
```

event Event.

Return:

The event type. Normally associated with a enum. Examples in `core_event_t`, `gui_event_t`.

event_sender

Get the event sender.

```
type*
event_sender(Event *event,
             type);
```

event Event.

type Sender type.

Return:

Sender.

event_params

Get the event parameters, encapsulated in a structure, which will be different depending on the event type.

```
type*
event_params(Event *event,
            type);
```

event Event.

type Parameters type.

Return:

Event parameters.

event_result

Gets an object to write the results of the event. Some events require the return of data by the receiver. The type of result object will depend on the type of event.

```
type*
event_result(Event *event,
            type);
```

event Event.

type Result type.

Return:

Event results.

keybuf_create

Create a buffer with keyboard status.

```
KeyBuf*
keybuf_create(void);
```

Return:

The buffer.

keybuf_destroy

Destroy the buffer.

```
void
keybuf_destroy(KeyBuf **bufer);
```

bufer The buffer. It will be set to `NULL` after the destruction.

keybuf_OnUp

Set the state of a key as released.

```
void
keybuf_OnUp(KeyBuf *bufer,
            const vkey_t key);
```

bufer The buffer.

key The key code.

Remarks:

Normally it will not be necessary to call this function. It will be done by `View` or the module that captures keyboard events.

keybuf_OnDown

Sets the state of a key as pressed.

```
void
keybuf_OnDown(KeyBuf *bufer,
              const vkey_t key);
```

bufer The buffer.
key The key code.

Remarks:

Normally it will not be necessary to call this function. It will be done by `View` or the module that captures keyboard events.

keybuf_clear

Clear the buffer. Set all keys as released.

```
void
keybuf_clear(KeyBuf *bufer);
```

bufer The buffer.

Remarks:

Normally it will not be necessary to call this function. It will be done by `View` or the module that captures keyboard events.

keybuf_pressed

Returns the state of a key.

```
bool_t
keybuf_pressed(const KeyBuf *bufer,
               const vkey_t key);
```

bufer The buffer.
key The key code.

Return:

Pulsed (`TRUE`) or released (`FALSE`).

keybuf_str

Returns a text string associated with a key.

```
void
keybuf_str(const vkey_t key);
```

key The key code.

keybuf_dump

Dump the buffer status into the “Log” (page 192).

```
void
keybuf_dump(const KeyBuf *bufer);
```

bufer The buffer.

hfile_dir

Check if the path is a directory.

```
bool_t
hfile_dir(const char_t *pathname);
```

pathname Name of the path to check. “Filename and pathname” (page 186).

Return:

TRUE if pathname is a directory. If it does not exist or is a file **FALSE**.

hfile_dir_create

Create all intermediate subdirectories of a path.

```
bool_t
hfile_dir_create(const char_t *pathname,
                ferror_t *error);
```

```
// C:\dir1 doesn't exist.
bool_t ok = hfile_dir_create("C:\dir1\dir2\dir3\dir4\dir5");
ok = TRUE
```

pathname Name of the path to create. “Filename and pathname” (page 186).

error Error code if the function fails. Can be **NULL**.

Return:

TRUE if the entire path has been created, otherwise **FALSE**.

hfile_dir_destroy

Recursive destroy a directory and all its contents.

```
bool_t
hfile_dir_destroy(const char_t *pathname,
                 ferror_t *error);
```

pathname Directory path to destroy. “*Filename and pathname*” (page 186).
 error Error code if the function fails. Can be `NULL`.

Return:

`TRUE` if the directory has been destroyed, or `FALSE` if there has been an error.

hfile_dir_list

Get a list of the contents of a directory.

```
ArrSt(DirEntry)*
hfile_dir_list(const char_t *pathname,
              ferror_t *error);
```

pathname Directory path to list. “*Filename and pathname*” (page 186).
 error Error code if the function fails. Can be `NULL`.

Return:

Array of `DirEntry` with the content. It must be destroyed with `arrst_destroy(&array, hfile_dir_entry_remove, DirEntry)` when it is no longer necessary.

hfile_dir_entry_remove

Free the memory of an item in the directory listing.

```
void
hfile_dir_entry_remove(DirEntry *entry);
```

entry Element.

Remarks:

See `hfile_dir_list`.

hfile_date

Gets the most recent modification date of a file or directory.

```
Date
hfile_date(const char_t *pathname,
          const bool_t recursive);
```

pathname Path to file or directory. “*Filename and pathname*” (page 186).
 recursive If `pathname` is a directory, it indicates whether to do a deep scan through subdirectories.

Return:

The modification date. If `pathname` does not exist `kDATE_NULL`.

Remarks:

If `pathname` is a directory, the modification dates of the files will be considered as well, not just the directory itself.

hfile_dir_sync

Synchronize the contents of two directories.

```
bool_t
hfile_dir_sync(const char_t *src,
               const char_t *dest,
               const bool_t recursive,
               const bool_t remove_in_dest,
               const char_t **except,
               const uint32_t except_size,
               ferror_t *error);
```

`src` Source directory.

`dest` Destination directory.

`recursive` If `TRUE` recursive process the subdirectories.

`remove_in_dest` If `TRUE` removes in `dest` those files/directories that are not in `src`.

`except` List of file/directory names that will remain intact in `dest`.

`except_size` Array except size.

`error` Error code if the function fails. Can be `NULL`.

Return:

`TRUE` if everything went well, `FALSE` if there has been an error.

Remarks:

If a file is in `src` and not in `dest`, is copied to `dest`. If a file is newer in `src` it is also copied in `dest`. If a file exists in `dest` but not in `src` and `remove_in_dest` is `TRUE`, will be removed from `dest`. If the file exists in `except` array it will not be taken into account to copy or delete. If `recursive` is `TRUE` subdirectories will be processed in this way: If both subdirs exist in `src` and `dest` the same logic described here will be executed in both subdirs. If the subdir exists in `src` but not in `dest`, will be copied in its entirety to `dest`. If it exists in `dest` and not in `src` and `remove_in_dest` is `TRUE` will be completely removed from `dest`.

hfile_exists

Check if pathname exists in the file system.

```
bool_t
hfile_exists(const char_t *pathname,
             file_type_t *file_type);
```

pathname Path of the directory or file to check. “*Filename and pathname*” (page 186).

file_type Type of file. It can be `NULL`.

Return:

`TRUE` if pathname exists, `FALSE` if not.

hfile_is_uptodate

Check if a file is up to date. Consider that dest is a copy or depends on src.

```
bool_t
hfile_is_uptodate(const char_t *src,
                 const char_t *dest);
```

src Source file pathname.

dest Destiny file pathname.

Return:

`TRUE` if dest exists and is more recent than src, otherwise `FALSE`.

hfile_copy

Copy a file from one location to another.

```
bool_t
hfile_copy(const char_t *src,
           const char_t *dest,
           ferror_t *error);
```

```
hfile_copy("/home/john/image.png", "/home/john/images", NULL); // image.png
hfile_copy("/home/john/image.png", "/home/john/images/party.png", NULL); //
↳ party.png
```

src Pathname of the file to copy. “*Filename and pathname*” (page 186).

dest Copy destination. If it is a directory it will have the same *filename* as the source. Otherwise, the copy will be made with another file name.

error Error code if the function fails. It can be `NULL`.

Return:

`TRUE` if the copy was successful. Otherwise `FALSE`.

hfile_buffer

Create a buffer with the contents of a file on disk.

```
Buffer*
hfile_buffer(const char_t *pathname,
             ferror_t *error);
```

pathname File path to load.

error Error code if the function fails. It can be `NULL`.

Return:

The buffer with the file data or `NULL` if the function fails.

Remarks:

It does not work with files larger than 4Gb (32-bit).

hfile_string

Create a string with the contents of a file on disk.

```
String*
hfile_string(const char_t *pathname,
             ferror_t *error);
```

pathname File path to load.

error Error code if the function fails. It can be `NULL`.

Return:

The string object with the text file data or `NULL` if the function fails.

Remarks:

It does not work with files larger than 4Gb (32-bit).

hfile_stream

Create a “*Memory stream*” (page 203) and initializes it with the contents of a file.

```
Stream*
hfile_stream(const char_t *pathname,
             ferror_t *error);
```

pathname File path to load.
 error Error code if the function fails. It can be `NULL`.

Return:

The stream initialized with the file data or `NULL` if the function fails.

Remarks:

It does not work with files larger than 4Gb (32-bit).

hfile_from_string

Create a file on disk with the contents of a “*Strings*” (page 200).

```
bool_t
hfile_from_string(const char_t *pathname,
                 const String *str,
                 ferror_t *error);
```

pathname File path to save.
 str String to save to file.
 error Error code if the function fails. It can be `NULL`.

Return:

`TRUE` if the file has been created successfully. Otherwise `FALSE`.

hfile_from_data

Create a file on disk with the contents of a generic block of memory.

```
bool_t
hfile_from_data(const char_t *pathname,
               const byte_t *data,
               const uint32_t size,
               ferror_t *error);
```

pathname File path to save.
 data Block to save in the file.
 size Block size in bytes.
 error Error code if the function fails. It can be `NULL`.

Return:

`TRUE` if the file has been created successfully. Otherwise `FALSE`.

hfile_dir_loop

Browse all the files in a directory.

```

bool_t
hfile_dir_loop(const char_t *pathname,
               listener *listener,
               const bool_t subdirs,
               const bool_t hiddens,
               ferror_t *error);

```

```

static void i_OnEntry(App *app, Event *event)
{
    uint32_t type = event_type(event);
    const EvFileDir *p = event_params(event, EvFileDir);
    if (type == ekEFILE)
    {
        bstd_printf("File: %s\n", p->pathname);
        // Abort the directory loop
        if (app->more == FALSE)
        {
            bool_t *more = event_result(event, bool_t);
            *more = FALSE;
        }
    }
    else if (type == ekENTRY)
    {
        if (app->direntry == TRUE)
        {
            bstd_printf("Entering: %s\n", params->pathname);
        }
        else
        {
            bool_t *entry = event_result(event, bool_t);
            *entry = FALSE;
        }
    }
    else if (type == ekEXIT)
    {
        bstd_printf("Exiting: %s\n", params->pathname);
    }
}

hfile_dir_loop("/home/john/personal", listener(app, i_OnEntry, App), TRUE,
               ↪ FALSE, NULL);

```

- pathname Directory Path. “*Filename and pathname*” (page 186).
- listener *Callback* function to be called for each directory file.
- subdirs If `TRUE` the loop will process the subdirectories.
- hiddens If `TRUE` hidden files will be processed.
- error Error code if the function fails. It can be `NULL`.

Return:

`TRUE` if the loop has been successfully completed. `FALSE` if an error has occurred.

Remarks:

For each file, an event will be sent to `listener`. Will be of type `ekEFILE` for regular files, `ekEENTRY` when enters a subdirectory and `ekEEXIT` when leaves it. The file attributes are sent in the event parameter as a `EvFileDir` object. The tour will continue until all files/subdirectories have been processed or returned `FALSE` in `event_result`. This controlled output will not be considered an error and this function will return `TRUE`.

hfile_appdata

Get the full path of a data file or application settings.

```
String*
hfile_appdata(const char_t *pathname);
```

```
String *fname = hfile_appdata("gui/preferences.cfg");
fname = "C:\Users\USER\AppData\Roaming\MyApp\gui\preferences.cfg"
(in Windows operating system)
...
Stream *out = stm_to_file(tc(fname), NULL);
```

- pathname Relative file path.

Return:

The full path to the configuration file.

Remarks:

In many cases, applications need to create configuration files to remember user preferences or other data between sessions “*Home and AppData*” (page 187). This function adds a relative path and file name and ensures that all intermediate directories will exist.

hfile_home_dir

Get the full path to a file in the user's (**home**) directory.

```
String*
hfile_home_dir(const char_t *path);
```

path Relative path from the **home** directory.

Return:

Absolute file path.

respack_destroy

Destroy a resource package.

```
void
respack_destroy(ResPack **pack);
```

pack Resource Package. Will be set to **NULL** after destruction.

respack_text

Get a text from a resource package.

```
const char_t*
respack_text(const ResPack *pack,
             const ResId id);
```

pack Resource package.

id Resource identifier.

Return:

UTF8 C string terminated in null character '\0'.

respack_file

Get a pointer to the contents of a file, included in a resource package.

```
const byte_t*
respack_file(const ResPack *pack,
             const ResId id,
             uint32_t *size);
```

pack Resource package.

id Resource identifier.

size Get the file size in bytes.

Return:

Pointer to file content (raw bytes).

date_system

Get the system date.

```
Date
date_system(void);
```

Return:

The current date.

date_pack

Pack a date.

```
Date
date_pack(const int16_t year,
          const uint8_t month,
          const uint8_t mday,
          const uint8_t hour,
          const uint8_t minute,
          const uint8_t second);
```

year Year.

month Month number (1,12).

mday Day of the month (1,31).

hour Hour (0,23).

minute Minute (0,59).

second Second (0,59).

Return:

The packaged date.

date_add_seconds

Calculate the date resulting from adding an amount of seconds to another date.

```
Date
date_add_seconds(const Date *date,
                int32_t seconds);
```

- date The base date.
- seconds The number of seconds. If it is positive we will obtain a future date. If negative, a past date.

Return:

The result date.

date_add_minutes

Calculate the date resulting from adding an amount of minutes to another date.

```
Date
date_add_minutes(const Date *date,
                 int32_t minutes);
```

- date The base date.
- minutes The number of minutes. If it is positive we will obtain a future date. If negative, a past date.

Return:

The result date.

date_add_hours

Calculate the date resulting from adding an amount of hours to another date.

```
Date
date_add_hours(const Date *date,
               int32_t hours);
```

- date The base date.
- hours The number of hours. If it is positive we will obtain a future date. If negative, a past date.

Return:

The result date.

date_add_days

Calculate the date resulting from adding an amount of days to another date.

```
Date
date_add_days(const Date *date,
              int32_t days);
```

`date` The base date.

`days` The number of days. If it is positive we will obtain a future date. If negative, a past date.

Return:

The result date.

date_year

Obtiene el año actual.

```
int16_t
date_year(void);
```

Return:

El año actual.

date_cmp

Compare two dates. The most recent date is considered greater.

```
int
date_cmp(const Date *date1,
         const Date *date2);
```

`date1` First date to compare.

`date2` Second date to compare.

Return:

Comparison result.

date_ellapsed_seconds

Calculates the number of seconds elapsed between two dates.

```
int64_t
date_ellapsed_seconds(const Date *from,
                    const Date *to);
```

`from` Start date.

`to` Final date.

Return:

Number of seconds. It can be negative, if `from` is after `to`.

date_between

Check if a date is within a range.

```
bool_t  
date_between(const Date *date,  
             const Date *from,  
             const Date *to);
```

date Date to check.

from Start date.

to Final date.

Return:

TRUE if date is between `from` and `to`.

date_is_null

Checks if a date is null.

```
bool_t  
date_is_null(const Date *date);
```

date Date to check.

Return:

TRUE if date is null.

date_is_valid

Checks if a date is valid.

```
bool_t  
date_is_valid(const Date *date);
```

date Date to check.

Return:

TRUE if date is valid.

date_weekday

Calculates the day of the week of a date.

```
week_day_t  
date_weekday(const Date *date);
```

date Date.

Return:

Weekday.

date_format

Returns a string with a formatted date.

```
const String*
date_format(const Date *date,
            const char_t *format);
```

date Date.

format The specified format, based on `strftime()`.

Return:

String with date.

Remarks:

See “*Date conversion*” (page 167).

clock_create

Create a clock.

```
Clock*
clock_create(const real64_t interval);
```

interval Time interval for animation control (in seconds).

Return:

The new clock.

clock_destroy

Destroy the clock.

```
void
clock_destroy(Clock **clk);
```

clk Clock. Will be set to `NULL` after destruction.

clock_frame

Detect if a new sequence in an animation has expired.

```
bool_t
clock_frame(Clock *clk,
            real64_t *prev_frame,
            real64_t *curr_frame);
```

clk Clock.

prev_frame Time mark of the previous instant. Only relevant if returns **TRUE**.

curr_frame Time mark of the current instant. Only relevant if returns **TRUE**.

Return:

TRUE if the time has come to launch a new sequence. **FALSE** if we have to wait.

clock_reset

Set the clock to 0.0.

```
void
clock_reset(Clock *clk);
```

clk Clock.

clock_elapsed

Gets the time elapsed since the object was created or since the last call to `clock_reset`.

```
real64_t
clock_elapsed(Clock *clk);
```

clk Clock.

Return:

The number of seconds (with precision of micro-seconds 0.000001).

Geom2D library

41.1. Types and Constants

kZERO

The (0,0) vector.

```
const V2Df kV2D_ZEROf;  
const V2Dd kV2D_ZEROd;  
const V2D V2D::kZERO;
```

kX

The (1,0) vector.

```
const V2Df kV2D_Xf;  
const V2Dd kV2D_Xd;  
const V2D V2D::kX;
```

kY

The (,1) vector.

```
const V2Df kV2D_Yf;  
const V2Dd kV2D_Yd;  
const V2D V2D::kY;
```

kZERO

[0,0] value.

```
const S2Df kS2D_ZEROf;  
const S2Dd kS2D_ZEROd;  
const S2D S2D::kZERO;
```

kZERO

Value [0, 0, 0, 0].

```
const R2Df kR2D_ZEROf;
const R2Dd kR2D_ZEROd;
const R2D R2D::kZERO;
```

kIDENT

Represents the identity transformation.

```
const T2Df kT2D_IDENTf;
const T2Dd kT2D_IDENTd;
const T2D T2D::kIDENT;
```

kNULL

Represents a null circle (no geometry).

```
const Cir2Df kCIR2D_NULLf;
const Cir2Dd kCIR2D_NULLd;
const Cir2D Cir2D::kNULL;
```

kNULL

Represents a null box (without geometry).

```
const Box2Df kBOX2D_NULLf;
const Box2Dd kBOX2D_NULLd;
const Box2D Box2D::kNULL;
```

struct V2D

Represents a 2d vector or point. “2D Vectors” (page 245).

```
struct V2Df
{
    real32_t x;
    real32_t y;
};

struct V2Dd
{
    real64_t x;
    real64_t y;
};
```

```

struct V2D
{
    real x;
    real y;
};

```

x Coordinate x.

y Coordinate y.

struct S2D

Represents a 2d size. “2D Size” (page 248).

```

struct S2Df
{
    real32_t width;
    real32_t height;
};

struct S2Dd
{
    real64_t width;
    real64_t height;
};

struct S2D
{
    real width;
    real height;
};

```

width Width.

height Height.

struct R2D

2d rectangle. “2D Rectangles” (page 248).

```

struct R2Df
{
    V2Df pos;
    S2Df size;
};

struct R2Dd
{
    V2Dd pos;
    S2Dd size;
};

```

```
};

struct R2D
{
    V2D pos;
    S2D size;
};
```

pos Origin.

size Size.

struct T2D

2d affine transformation. “*2D Transformations*” (page 249).

```
struct T2Df
{
    V2Df i;
    V2Df j;
    V2Df p;
};

struct T2Dd
{
    V2Dd i;
    V2Dd j;
    V2Dd p;
};

struct T2D
{
    V2D i;
    V2D j;
    V2D p;
};
```

i Component i of the linear transformation.

j Component j of the linear transformation.

p Position.

struct Seg2D

2d line segment. “*2D Segments*” (page 254).

```
struct Seg2Df
{
    V2Df p0;
    V2Df p1;
```

```
};

struct Seg2Dd
{
    V2Dd p0;
    V2Dd p1;
};

struct Seg2D
{
    V2D p0;
    V2D p1;
};
```

p0 Coordinate of the first point of the segment.

p1 Coordinate of the second point of the segment.

struct Cir2D

2d circle. “2D Circles” (page 255).

```
struct Cir2Df
{
    V2Df c;
    real32_t r;
};

struct Cir2Dd
{
    V2Dd c;
    real64_t r;
};

struct Cir2D
{
    V2D c;
    real r;
};
```

c Center.

r Radix.

struct Box2D

2d bounding box. “2D Boxes” (page 255).

```
struct Box2Df
{
```

```

    V2Df min;
    V2Df max;
};

struct Box2Dd
{
    V2Dd min;
    V2Dd max;
};

struct Box2D
{
    V2D min;
    V2D max;
};

```

`min` Minimum bounding coordinate.

`max` Maximum bounding coordinate.

struct OBB2D

2d Oriented Bounding Box. “*2D Oriented Boxes*” (page 255).

```

struct OBB2Df;

struct OBB2Dd;

struct OBB2D;

```

struct Tri2D

2d triangle. “*2D Triangles*” (page 257).

```

struct Tri2Df
{
    V2Df p0;
    V2Df p1;
    V2Df p2;
};

struct Tri2Dd
{
    V2Dd p0;
    V2Dd p1;
    V2Dd p2;
};

struct Tri2D
{

```

```

V2D p0;
V2D p1;
V2D p2;
};

```

- p0 Coordinate of the first point of the triangle.
- p1 Coordinate of the second point of the triangle.
- p2 Coordinate of the third point of the triangle.

struct Pol2D

2d convex polygon. “*2D Polygons*” (page 258).

```

struct Pol2Df;

struct Pol2Dd;

struct Pol2D;

```

struct Col2D

Collision data in 2d. “*2D Collisions*” (page 261).

```

struct Col2Df;

struct Col2Dd;

struct Col2D;

```

41.2. Functions

v2d

Create a 2d vector from its components.

```

V2Df
v2df(const real32_t x,
      const real32_t y);

V2Dd
v2dd(const real64_t x,
      const real64_t y);

V2D
V2D(const real x,
     const real y);

```

x X coordinate.

y Y coordinate.

Return:

2d vector.

v2d_tof

Convert a vector from double to float.

```
V2Df
v2d_tof(const V2Dd *v);
```

v Vector.

Return:

The 2d vector in simple precision.

v2d_tod

Convert a vector from float to double.

```
V2Dd
v2d_tod(const V2Df *v);
```

v Vector.

Return:

The 2d vector in double precision.

v2d_tofn

Converts a vector array from double to float.

```
void
v2d_tofn(V2Df *vf,
         const V2Dd *vd,
         const uint32_t n);
```

vf The destination array.

vd The source array.

n Number of elements.

v2d_todn

Converts a vector array from float to double.

```
void
v2d_todn(V2Dd *vd,
         const V2Df *vf,
         const uint32_t n);
```

vd The destination array.

vf The source array.

n Number of elements.

v2d_add

Add two vectors.

```
V2Df
v2d_addf(const V2Df *v1,
         const V2Df *v2);

V2Dd
v2d_addd(const V2Dd *v1,
         const V2Dd *v2);

V2D
V2D::add(const V2D *v1,
         const V2D *v2);
```

v1 Vector 1.

v2 Vector 2.

Return:

The result vector.

v2d_sub

Subtract two vectors.

```
V2Df
v2d_subf(const V2Df *v1,
         const V2Df *v2);

V2Dd
v2d_subd(const V2Dd *v1,
         const V2Dd *v2);
```

```
V2D
V2D::sub(const V2D *v1,
         const V2D *v2);
```

v1 Vector 1.

v2 Vector 2.

Return:

The result vector.

v2d_mul

Multiply a vector by a scalar.

```
V2Df
v2d_mulf(const V2Df *v,
         const real32_t s);

V2Dd
v2d_muld(const V2Dd *v,
         const real64_t s);

V2D
V2D::mul(const V2D *v,
         const real s);
```

v Vector.

s Scalar.

Return:

The result vector.

v2d_from

Create a vector from a point and a direction.

```
V2Df
v2d_fromf(const V2Df *v,
          const V2Df *dir,
          const real32_t length);

V2Dd
v2d_fromd(const V2Dd *v,
          const V2Dd *dir,
          const real64_t length);

V2D
```

```
V2D::from(const V2D *v,
         const V2D *dir,
         const real length);
```

v Initial vector.

dir Direction.

length Length.

Return:

The result vector.

Remarks:

It will perform the operation $r = v + \text{length} * \text{dir}$. `dir` does not need to be unitary, in which case `length` will behave as a scale factor.

v2d_mid

Returns the midpoint of two points.

```
V2Df
v2d_midf(const V2Df *v1,
        const V2Df *v2);

V2Dd
v2d_midd(const V2Dd *v1,
        const V2Dd *v2);

V2D
V2D::mid(const V2D *v1,
        const V2D *v2);
```

v1 First point.

v2 Second point.

Return:

The middle point.

v2d_unit

Unit vector (direction) from 1 to 2.

```
V2Df
v2d_unitf(const V2Df *v1,
         const V2Df *v2,
         real32_t *dist);
```

```

V2Dd
v2d_unitd(const V2Dd *v1,
          const V2Dd *v2,
          real64_t *dist);

V2D
V2D::unit(const V2D *v1,
          const V2D *v2,
          real *dist);

```

v1 Point 1 (origin).

v2 Point 2 (destination).

dist Distance between points. Can be **NULL**.

Return:

The unit vector.

v2d_unit_xy

Unit vector (direction) from 1 to 2.

```

V2Df
v2d_unit_xyf(const real32_t x1,
             const real32_t y1,
             const real32_t x2,
             const real32_t y2,
             real32_t *dist);

V2Dd
v2d_unit_xyd(const real64_t x1,
             const real64_t y1,
             const real64_t x2,
             const real64_t y2,
             real64_t *dist);

V2D
V2D::unit_xy(const real x1,
             const real y1,
             const real x2,
             const real y2,
             real *dist);

```

- x1 X coordinate of point 1 (origin).
- y1 Y coordinate of point 1 (origin).
- x2 X coordinate of point 2 (destination).
- y2 Y coordinate of point 2 (destination).
- dist Distance between points. Can be `NULL`.

Return:

The unit vector.

v2d_perp_pos

Gets the positive perpendicular vector.

```
V2Df
v2d_perp_posf(const V2Df *v);

V2Dd
v2d_perp_posd(const V2Dd *v);

V2D
V2D::perp_pos(const V2D *v);
```

v Initial vector.

Return:

The perpendicular vector.

Remarks:

It is the perpendicular obtained by positive angle ($+ / 2$).

v2d_perp_neg

Gets the negative perpendicular vector.

```
V2Df
v2d_perp_negf(const V2Df *v);

V2Dd
v2d_perp_negd(const V2Dd *v);

V2D
V2D::perp_neg(const V2D *v);
```

v Initial vector.

Return:

The perpendicular vector.

Remarks:

It is the perpendicular obtained by negative angle ($-\pi/2$).

v2d_from_angle

Gets the vector resulting from applying a rotation to the vector $[1, 0]$.

```
V2Df
v2d_from_anglef(const real32_t a);

V2Dd
v2d_from_angled(const real64_t a);

V2D
V2D::from_angle(const real a);
```

a Angle.

Return:

The vector.

Remarks:

For $a=0$ we get $[1, 0]$. For $a=\pi/2$ $[0, 1]$.

v2d_norm

Normalize a vector, that is, make it a vector of length = 1.

```
bool_t
v2d_normf(V2Df *v);

bool_t
v2d_normd(V2Dd *v);

bool_t
V2D::norm(V2D *v);
```

v Vector that will be normalized.

Return:

FALSE if the vector cannot be normalized (vector 0).

v2d_length

Calculate the length of a vector.

```
real32_t
v2d_lengthf(const V2Df *v);

real64_t
v2d_lengthd(const V2Dd *v);

real
V2D::length(const V2D *v);
```

v Vector.

Return:

The vector module.

v2d_slength

Calculate the square of the length of a vector.

```
real32_t
v2d_slengthf(const V2Df *v);

real64_t
v2d_slengthd(const V2Dd *v);

real
V2D::slength(const V2D *v);
```

v Vector.

Return:

The square of the vector modulus.

Remarks:

Avoid using the square root, so it is more efficient than `v2d_lengthf`. Often used to compare distances.

v2d_dot

Product of two vectors.

```
real32_t
v2d_dotf(const V2Df *v1,
         const V2Df *v2);
```



```

real64_t
v2d_dotd(const V2Dd *v1,
         const V2Dd *v2);

real
V2D::dot(const V2D *v1,
         const V2D *v2);

```

v1 Vector 1.

v2 Vector 2.

Return:

Scalar product.

v2d_dist

Calculate the distance between two points.

```

real32_t
v2d_distf(const V2Df *v1,
          const V2Df *v2);

real64_t
v2d_distd(const V2Dd *v1,
          const V2Dd *v2);

real
V2D::dist(const V2D *v1,
          const V2D *v2);

```

v1 The first point.

v2 The second point.

Return:

Distance.

v2d_sqdist

Calculate the square of the distance between two points.

```

real32_t
v2d_sqdistf(const V2Df *v1,
            const V2Df *v2);

real64_t
v2d_sqdistd(const V2Dd *v1,
            const V2Dd *v2);

```

```

        const V2Dd *v2);

real
V2D::sqdist(const V2D *v1,
            const V2D *v2);

```

v1 The first point.

v2 The second point.

Return:

The distance squared.

Remarks:

It avoids using the square root, so it is more efficient than `v2d_distf`. Often used to compare distances.

v2d_angle

Calculate the angle formed by two vectors.

```

real32_t
v2d_anglef(const V2Df *v1,
           const V2Df *v2);

real64_t
v2d_angled(const V2Dd *v1,
           const V2Dd *v2);

real
V2D::angle(const V2D *v1,
           const V2D *v2);

```

v1 Vector 1.

v2 Vector 2.

Return:

The angle in radians (-Pi, Pi)

Remarks:

Positive angles go from v1 to v2 counterclockwise. For angles greater than Pi radians (180°) it will return negative (clockwise).

v2d_rotate

Apply a rotation to a vector.

```

void
v2d_rotatef(V2Df *v,
            const real32_t a);

void
v2d_rotated(V2Dd *v,
            const real64_t a);

void
V2D::rotate(V2D *v,
            const real a);

```

v Vector to be rotated (origin/destination.

a Angle in radians.

Remarks:

This function involves calculating the sine and cosine. Use `t2d_vmultnf` if you have to apply the same rotation to multiple vectors.

s2d

Create a 2d size from two values.

```

S2Df
s2df(const real32_t width,
     const real32_t height);

S2Dd
s2dd(const real64_t width,
     const real64_t height);

S2D
S2D(const real width,
    const real height);

```

width Width.

height Height.

Return:

The size.

r2d

Create a rectangle from its components.

```

R2Df
r2df(const real32_t x,
     const real32_t y,
     const real32_t width,
     const real32_t height);

R2Dd
r2dd(const real64_t x,
     const real64_t y,
     const real64_t width,
     const real64_t height);

R2D
R2D(const real x,
    const real y,
    const real width,
    const real height);

```

x Origin x coordinate.

y Coordinate and origin.

width Width.

height Height.

Return:

The rectangle.

r2d_center

Gets the center point of the rectangle.

```

V2Df
r2d_centerf(const R2Df *r2d);

V2Dd
r2d_centerd(const R2Dd *r2d);

V2D
R2D::center(const R2D *r2d);

```

r2d Rectangle.

Return:

The center.

r2d_collide

Check if two rectangles collide.

```

bool_t
r2d_collidef(const R2Df *r2d1,
             const R2Df *r2d2);

bool_t
r2d_collided(const R2Dd *r2d1,
             const R2Dd *r2d2);

bool_t
R2D::collide(const R2D *r2d1,
             const R2D *r2d2);

```

r2d1 Rectangle 1.

r2d2 Rectangle 2.

Return:

TRUE if there is collision, **FALSE** if they are separated.

r2d_contains

Check if a point is inside the rectangle.

```

bool_t
r2d_containsf(const R2Df *r2d,
             const real32_t x,
             const real32_t y);

bool_t
r2d_containsd(const R2Dd *r2d,
             const real64_t x,
             const real64_t y);

bool_t
R2D::contains(const R2D *r2d,
             const real x,
             const real y);

```

r2d Rectangle.

x X coordinate of the point.

y Coordinate and point.

Return:

TRUE if the point is inside.

r2d_clip

Check if a rectangle, or part of it, is contained in another rectangle.

```
bool_t
r2d_clipf(const R2Df *viewport,
          const R2Df *r2d);

bool_t
r2d_clipd(const R2Dd *viewport,
          const R2Dd *r2d);

bool_t
R2D::clip(const R2D *viewport,
          const R2D *r2d);
```

viewport Container rectangle.

r2d Rectangle to check.

Return:

TRUE if the r2d rectangle is completely outside of viewport.

Remarks:

Useful to avoid processing or drawing objects that are totally outside the viewing area.

r2d_join

Join two rectangles into one.

```
void
r2d_joinf(R2Df *r2d,
          const R2Df *src);

void
r2d_joind(R2Dd *r2d,
          const R2Dd *src);

void
R2D::join(R2D *r2d,
          const R2D *src);
```

r2d Destination rectangle. Its position and size will be modified to contain src.

src Rectangle to be added to r2d.

t2d_tof

Converts a transformation from double to float.

```
void
t2d_tof(T2Df *dest,
        const T2Dd *src);
```

dest Destination transformation.

src Origin transformation.

t2d_tod

Converts a transform from float to double.

```
void
t2d_tod(T2Dd *dest,
        const T2Df *src);
```

dest Destination transformation.

src Origin transformation.

t2d_move

Multiply a transformation by a translation $t2d = src * move(x, y)$.

```
void
t2d_movef(T2Df *dest,
          const T2Df *src,
          const real32_t x,
          const real32_t y);

void
t2d_moved(T2Dd *dest,
          const T2Dd *src,
          const real64_t x,
          const real64_t y);

void
T2D::move(T2D *dest,
          const T2D *src,
          const real x,
          const real y);
```

- dest Result transformation.
- src Initial transformation.
- x X coordinate of displacement.
- y Y coordinate of displacement.

Remarks:

dest and src can point to the same matrix.

t2d_rotate

Multiply a transformation by a rotation `dest = src * rotate(a)`.

```
void
t2d_rotatef(T2Df *dest,
            const T2Df *src,
            const real32_t a);

void
t2d_rotated(T2Dd *dest,
            const T2Dd *src,
            const real64_t a);

void
T2D::rotate(T2D *dest,
            const T2D *src,
            const real a);
```

- dest Result transformation.
- src Initial transformation.
- a Rotation angle in radians. Positive angles are those that rotate from the X axis to the Y axis.

Remarks:

dest and src can point to the same matrix.

t2d_scale

Multiply a transformation by an scale `dest = src * scale(sx, sy)`.

```
void
t2d_scalef(T2Df *dest,
            const T2Df *src,
            const real32_t sx,
            const real32_t sy);
```



```

void
t2d_scaled(T2Dd *dest,
           const T2Dd *src,
           const real64_t sx,
           const real64_t sy);

void
T2D::scale(T2D *dest,
           const T2D *src,
           const real sx,
           const real sy);

```

dest Result transformation.

src Initial transformation.

sx Scaling on the x axis.

sy Scaling on the y axis.

Remarks:

dest and src can point to the same matrix.

t2d_invfast

Calculate the inverse transformation, assuming the input is orthogonal.

```

void
t2d_invfastf(T2Df *dest,
             const T2Df *src);

void
t2d_invfastd(T2Dd *dest,
             const T2Dd *src);

void
T2D::invfast(T2D *dest,
             const T2D *src);

```

dest Inverse transformation.

src Initial transformation.

Remarks:

The transformation will be orthogonal only if it contains rotations and translations, otherwise the result of applying it will be unpredictable. dest and src can point to the same matrix.

t2d_inverse

Calculate the inverse transformation.

```
void
t2d_inversef(T2Df *dest,
             const T2Df *src);

void
t2d_inversed(T2Dd *dest,
             const T2Dd *src);

void
T2D::inverse(T2D *dest,
             const T2D *src);
```

dest Inverse transformation.

src Initial transformation.

Remarks:

dest and src can point to the same matrix.

t2d_mult

Multiply two transformations $dest = src1 * src2$.

```
void
t2d_multf(T2Df *dest,
          const T2Df *src1,
          const T2Df *src2);

void
t2d_multd(T2Dd *dest,
          const T2Dd *src1,
          const T2Dd *src2);

void
T2D::mult(T2D *dest,
          const T2D *src1,
          const T2D *src2);
```

dest Result transformation.

src1 First operating.

src2 Second operating.

Remarks:

dest, src1 and src2 can point to the same matrix.

t2d_vmult

Transform a vector $dest = t2d * src$.

```

void
t2d_vmultf(V2Df *dest,
           const T2Df *t2d,
           const V2Df *src);

void
t2d_vmultd(V2Dd *dest,
           const T2Dd *t2d,
           const V2Dd *src);

void
T2D::vmult(V2D *dest,
           const T2D *t2d,
           const V2D *src);

```

dest Transformed vector.

t2d Transformation.

src Original vector.

Remarks:

dest and src can point to the same vector.

t2d_vmultn

Transform a vector list $dest[i] = t2d * src[i]$.

```

void
t2d_vmultnfv(V2Df *dest,
             const T2Df *t2d,
             const V2Df *src,
             const uint32_t n);

void
t2d_vmultnd(V2Dd *dest,
             const T2Dd *t2d,
             const V2Dd *src,
             const uint32_t n);

void
T2D::vmultn(V2D *dest,
            const T2D *t2d,
            const V2D *src,
            const uint32_t n);

```

dest Transformed vector array.
 t2d Transformation.
 src Original vector array.
 n Number of vectors in src.

Remarks:

dest and src can point to the same array.

t2d_decompose

Gets the position, rotation, and scaling of a transformation.

```

void
t2d_decomposef(const T2Df *t2d,
               V2Df *pos,
               real32_t *a,
               V2Df *sc);

void
t2d_decomposed(const T2Dd *t2d,
               V2Dd *pos,
               real64_t *a,
               V2Dd *sc);

void
T2D::decompose(const T2D *t2d,
               V2D *pos,
               real *a,
               V2D *sc);

```

t2d Transformation.
 pos Position. Can be **NULL**.
 a Angle in radians ($-\pi/2$, $\pi/2$). Can be **NULL**.
 sc Scaled. Can be **NULL**.

Remarks:

If the transformation is not made up of a sequence of translations, rotations, and scales, the result will not be valid.

seg2d

Create a 2d segment from its components.

```
Seg2Df
```

```

seg2df(const real32_t x0,
       const real32_t y0,
       const real32_t x1,
       const real32_t y1);

Seg2Dd
seg2dd(const real64_t x0,
       const real64_t y0,
       const real64_t x1,
       const real64_t y1);

Seg2D
Seg2D(const real x0,
      const real y0,
      const real x1,
      const real y1);

```

x0 X coordinate of the first point.

y0 Y coordinate of the first point.

x1 X coordinate of the second point.

y1 Y coordinate of the second point.

Return:

The 2d segment.

seg2d_v

Create a 2d segment from two points.

```

Seg2Df
seg2d_vf(const V2Df *p0,
        const V2Df *p1);

Seg2Dd
seg2d_vd(const V2Dd *p0,
        const V2Dd *p1);

Seg2D
Seg2D::v(const V2D *p0,
        const V2D *p1);

```

p0 First point.

p1 Second point.

Return:

The 2d segment.

seg2d_length

Gets the length of the segment.

```
real32_t
seg2d_lengthf(const Seg2Df *seg);

real64_t
seg2d_lengthd(const Seg2Dd *seg);

real
Seg2D::length(const Seg2D *seg);
```

seg Segment.

Return:

Length.

seg2d_slength

Gets the square of the segment length.

```
real32_t
seg2d_slengthf(const Seg2Df *seg);

real64_t
seg2d_slengthd(const Seg2Dd *seg);

real
Seg2D::slength(const Seg2D *seg);
```

seg Segment.

Return:

Length square.

Remarks:

Avoid calculating square roots if we are only interested in comparing measurements.

seg2d_eval

Gets the point in the segment based on the parameter.

```
V2Df
seg2d_evalf(const Seg2Df *seg,
            const real32_t t);

V2Dd
```

```
seg2d_evald(const Seg2Dd *seg,
           const real64_t t);
```

V2D

```
Seg2D::eval(const Seg2D *seg,
           const real t);
```

seg Segment.

t Parameter.

Return:

Point on the segment (or on the line that contains it).

Remarks:

If $t=0$ it returns p_0 . If $t=1$ it returns p_1 . Values between $(0,1)$ points within the segment. Other values, points on the line that contains the segment.

seg2d_close_param

Gets the parameter of the segment closest to a given point.

```
real32_t
seg2d_close_paramf(const Seg2Df *seg,
                  const V2Df *pnt);
```

```
real64_t
seg2d_close_paramd(const Seg2Dd *seg,
                  const V2Dd *pnt);
```

```
real
Seg2D::close_param(const Seg2D *seg,
                  const V2D *pnt);
```

seg Segment.

pnt Point.

Return:

Parameter. See `seg2d_evalf`.

seg2d_point_sqdist

Gets the squared distance from a point to the segment.

```
real32_t
seg2d_point_sqdistf(const Seg2Df *seg,
```

```

        const V2Df *pnt,
        real32_t *t);

real64_t
seg2d_point_sqdistd(const Seg2Dd *seg,
                   const V2Dd *pnt,
                   real64_t *t);

real
Seg2D::point_sqdist(const Seg2D *seg,
                   const V2D *pnt,
                   real *t);

```

seg Segment.

pnt Point.

t Parameter on the line that contains the segment. See `seg2d_close_paramf`. It can be `NULL` if we don't need this value.

Return:

Distance square.

seg2d_sqdist

Gets the squared distance between two segments.

```

real32_t
seg2d_sqdistf(const Seg2Df *seg1,
              const Seg2Df *seg2,
              real32_t *t1,
              real32_t *t2);

real64_t
seg2d_sqdistd(const Seg2Dd *seg1,
              const Seg2Dd *seg2,
              real64_t *t1,
              real64_t *t2);

real
Seg2D::sqdist(const Seg2D *seg1,
              const Seg2D *seg2,
              real *t1,
              real *t2);

```

seg1 First segment.

seg2 Second segment.

t1 Nearest parameter in seg1. It can be `NULL` if we don't need this value.

t2 Nearest parameter in seg2. It can be `NULL` if we don't need this value.

Return:

Distance square.

cir2d

Create a 2d circle from its components.

```
Cir2Df
cir2df(const real32_t x,
       const real32_t y,
       const real32_t r);

Cir2Dd
cir2dd(const real64_t x,
       const real64_t y,
       const real64_t r);

Cir2D
Cir2D(const real x,
      const real y,
      const real r);
```

x Center x coordinate.

y Center y coordinate.

r Radius.

Return:

The 2d circle.

cir2d_from_box

Create a circle containing a 2D box.

```
Cir2Df
cir2d_from_boxf(const B2D *box);

Cir2Dd
cir2d_from_boxd(const B2D *box);

Cir2D
```

```
Cir2D::from_box(const B2D *box);
```

box The box.

Return:

The circle.

cir2d_from_points

Create a circle containing a set of points.

```
Cir2Df
cir2d_from_pointsf(const V2Df *p,
                  const uint32_t n);

Cir2Dd
cir2d_from_pointsd(const V2Dd *p,
                  const uint32_t n);

Cir2D
Cir2D::from_points(const V2D *p,
                  const uint32_t n);
```

p The points vector.

n The number of points.

Return:

The circle.

Remarks:

The center will be the midpoint of the set. The radius will be the distance to the farthest point from that center. Provides a good fit with linear cost.

cir2d_minimum

Calculate the circle of minimum radius that contains a set of points.

```
Cir2Df
cir2d_minimumf(const V2Df *p,
              const uint32_t n);

Cir2Dd
cir2d_minimumd(const V2Dd *p,
              const uint32_t n);

Cir2D
```

```
Cir2D::minimum(const V2D *p,
               const uint32_t n);
```

p The points vector.

n The number of points.

Return:

The circle.

Remarks:

Provides optimal adjustment in linear time. However, it is slower than `cir2d_from_pointsf`.

cir2d_area

Gets the area of the circle.

```
real32_t
cir2d_areaf(const Cir2Df *cir);

real64_t
cir2d_aread(const Cir2Dd *cir);

real
Cir2D::area(const Cir2D *cir);
```

cir The circle.

Return:

The area $\pi(r^2)$.

cir2d_is_null

Check if a circle is null (dimensionless).

```
bool_t
cir2d_is_nullf(const Cir2Df *cir);

bool_t
cir2d_is_nulld(const Cir2Dd *cir);

bool_t
Cir2D::is_null(const Cir2D *cir);
```

cir The circle.

Return:

`TRUE` if it is null, `FALSE` if it contains any point.

Remarks:

A single point is a valid circle with radius = 0.

box2d

Create a new box with the indicated limits.

```
Box2Df
box2df(const real32_t minX,
       const real32_t minY,
       const real32_t maxX,
       const real32_t maxY);

Box2Dd
box2dd(const real64_t minX,
       const real64_t minY,
       const real64_t maxX,
       const real64_t maxY);

Box2D
Box2D(const real minX,
      const real minY,
      const real maxX,
      const real maxY);
```

`minX` The lower limit on X.

`minY` The lower limit on Y.

`maxX` The upper limit on X.

`maxY` The upper limit on Y.

Return:

The newly created box.

box2d_from_points

Create a new box containing a set of points.

```
Box2Df
box2d_from_pointsf(const V2Df *p,
                  const uint32_t n);

Box2Dd
```

```

box2d_from_pointsd(const V2Dd *p,
                  const uint32_t n);

Box2D
Box2D::from_points(const V2D *p,
                  const uint32_t n);

```

p 2d point vector.

n Number of points in vector.

Return:

The newly created box.

box2d_center

Returns the center point.

```

V2Df
box2d_centerf(const Box2Df *box);

V2Dd
box2d_centerd(const Box2Dd *box);

V2D
Box2D::center(const Box2D *box);

```

box The container.

Return:

Center coordinates.

box2d_add

Expand the dimensions of the box to contain the entry point. If the point is already within its area, the box is not modified.

```

void
box2d_addf(Box2Df *box,
           const V2Df *p);

void
box2d_addd(Box2Dd *box,
           const V2Dd *p);

void
Box2D::add(Box2D *box,
           const V2D *p);

```

- box The container.
- p The point to include.

box2d_addn

Expand the dimensions of the box to contain several points. It is equivalent to calling the method `box2d_addf` successively.

```
void
box2d_addnf(Box2Df *box,
            const V2Df *p,
            const uint32_t n);

void
box2d_addnd(Box2Dd *box,
            const V2Dd *p,
            const uint32_t n);

void
Box2D::addn(Box2D *box,
            const V2D *p,
            const uint32_t n);
```

- box The container.
- p Vector points to include.
- n Number of points.

box2d_add_circle

Expand the dimensions of the container to accommodate a circle.

```
void
box2d_add_circlef(Box2Df *box,
                  const Cir2Df *cir);

void
box2d_add_circle_d(Box2Dd *box,
                  const Cir2Dd *cir);

void
Box2D::add_circle(Box2D *box,
                  const Cir2D *cir);
```

- box The container.
- cir Circle.

box2d_merge

Expand the dimensions of `dest` to contain `src`.

```

void
box2d_mergef(Box2Df *dest,
             const Box2Df *src);

void
box2d_merged(Box2Dd *dest,
             const Box2Dd *src);

void
Box2D::merge(Box2D *dest,
             const Box2D *src);

```

`dest` The container that will be expanded.

`src` The container that must be added.

box2d_segments

Gets the four segments that make up the box.

```

void
box2d_segmentsf(const Box2Df *box,
               Seg2Df *segs);

void
box2d_segmentsd(const Box2Dd *box,
               Seg2Dd *segs);

void
Box2D::segments(const Box2D *box,
               Seg2D *segs);

```

`box` The container.

`segs` Array of at least four segments.

box2d_area

Gets the area of the box.

```

real32_t
box2d_areaf(const Box2Df *box);

real64_t
box2d_aread(const Box2Dd *box);

real

```

```
Box2D::area(const Box2D *box);
```

box The container.

Return:

The area (width * height).

box2d_is_null

Check if a container is null (without any geometry inside).

```
bool_t
box2d_is_nullf(const Box2Df *box);

bool_t
box2d_is_nulld(const Box2Dd *box);

bool_t
Box2D::is_null(const Box2D *box);
```

box The container.

Return:

TRUE if is null, **FALSE** if contains any geometry.

obb2d_create

Create a new oriented box.

```
OBB2Df*
obb2d_createf(const V2Df *center,
              const real32_t width,
              const real32_t height,
              const real32_t angle);

OBB2Dd*
obb2d_created(const V2Dd *center,
              const real64_t width,
              const real64_t height,
              const real64_t angle);

OBB2D*
OBB2D::create(const V2D *center,
              const real width,
              const real height,
              const real angle);
```

center The central point.
width The width of the box.
height The height of the box.
angle The angle with respect to the X axis, in radians.

Return:

The newly created box.

Remarks:

Positive angles are those that rotate from the X axis to the Y axis.

obb2d_from_line

Create a box from a segment.

```
OBB2Df*
obb2d_from_linef(const V2Df *p0,
                 const V2Df *p1,
                 const real32_t thickness);

OBB2Dd*
obb2d_from_lined(const V2Dd *p0,
                 const V2Dd *p1,
                 const real64_t thickness);

OBB2D*
OBB2D::from_line(const V2D *p0,
                 const V2D *p1,
                 const real thickness);
```

p0 The first point of the segment.

p1 The second point of the segment.

thickness The “thickness” of the segment.

Return:

The newly created box.

Remarks:

The width of the box will correspond to the length of the segment. The height will be thickness and the center will be the midpoint of the segment.

obb2d_from_points

Create an oriented box from a set of points.

```
OBB2Df*
obb2d_from_pointsf(const V2Df *p,
                  const uint32_t n);

OBB2Dd*
obb2d_from_pointsd(const V2Dd *p,
                  const uint32_t n);

OBB2D*
OBB2D::from_points(const V2D *p,
                  const uint32_t n);
```

p Points array.

n Number of points.

Return:

The newly created box.

Remarks:

A good fit will be produced in “elongated” point distributions by calculating the covariance matrix and projecting points onto the director vector of that distribution. However, it does not provide the minimum volume box.

obb2d_copy

Create a copy of the box.

```
OBB2Df*
obb2d_copyf(const OBB2Df obb);

OBB2Dd*
obb2d_copyd(const OBB2Dd obb);

OBB2D*
OBB2D::copy(const OBB2D obb);
```

obb Original box.

Return:

The copy.

obb2d_destroy

Destroy the box.

```

void
obb2d_destroyf(OBB2Df **obb);

void
obb2d_destroyd(OBB2Dd **obb);

void
OBB2D::destroy(OBB2D **obb);

```

obb The box. Will be set to `NULL` after destruction.

obb2d_update

Update the box parameters.

```

void
obb2d_updatef(OBB2Df *obb,
              const V2Df *center,
              const real32_t width,
              const real32_t height,
              const real32_t angle);

void
obb2d_updated(OBB2Dd *obb,
              const V2Dd *center,
              const real64_t width,
              const real64_t height,
              const real64_t angle);

void
OBB2D::update(OBB2D *obb,
              const V2D *center,
              const real width,
              const real height,
              const real angle);

```

obb The box to update.

center The central point.

width The width.

height The height.

angle The angle.

Remarks:

See `obb2d_createf`.

obb2d_move

Move the box on the plane.

```
void
obb2d_movef(OBB2Df *obb,
            const real32_t offset_x,
            const real32_t offset_y);

void
obb2d_moved(OBB2Dd *obb,
            const real64_t offset_x,
            const real64_t offset_y);

void
OBB2D::move(OBB2D *obb,
            const real offset_x,
            const real offset_y);
```

`obb` The box.

`offset_x` X displacement.

`offset_y` Y displacement.

obb2d_transform

Apply a transformation to the box.

```
void
obb2d_transformf(OBB2Df *obb,
                const T2Df *t2d);

void
obb2d_transformd(OBB2Dd *obb,
                const T2Dd *t2d);

void
OBB2D::transform(OBB2D *obb,
                const T2D *t2d);
```

`obb` The box.

`t2d` Affine transformation.

obb2d_corners

Gets the vertices bounding the box.

```

const V2Df*
obb2d_cornersf(const OBB2Df *obb);

const V2Dd*
obb2d_cornersd(const OBB2Dd *obb);

const V2D*
OBB2D::corners(const OBB2D *obb);

```

obb The box.

Return:

Pointer to an array of 4 vertices.

Remarks:

Do not modify the returned array. Copy if necessary.

obb2d_center

Gets the center point of the box.

```

V2Df
obb2d_centerf(const OBB2Df *obb);

V2Dd
obb2d_centerd(const OBB2Dd *obb);

V2D
OBB2D::center(const OBB2D *obb);

```

obb The box.

Return:

Center.

obb2d_width

Get the width of the box.

```

real32_t
obb2d_widthf(const OBB2Df *obb);

real64_t
obb2d_widthd(const OBB2Dd *obb);

real
OBB2D::width(const OBB2D *obb);

```

obb The box.

Return:

The width.

obb2d_height

Get the height of the box.

```
real32_t
obb2d_heightf(const OBB2Df *obb);

real64_t
obb2d_heightd(const OBB2Dd *obb);

real
OBB2D::height(const OBB2D *obb);
```

obb The box.

Return:

The height.

obb2d_angle

Get the angle of the box.

```
real32_t
obb2d_anglef(const OBB2Df *obb);

real64_t
obb2d_angled(const OBB2Dd *obb);

real
OBB2D::angle(const OBB2D *obb);
```

obb The box.

Return:

The angle in radians with respect to the X axis.

obb2d_area

Gets the box area.

```
real32_t
obb2d_areaf(const OBB2Df *obb);
```

```

real64_t
obb2d_aread(const OBB2Dd *obb);

real
OBB2D::area(const OBB2D *obb);

```

obb The box.

Return:

The area (width * height).

obb2d_box

Get the box limits.

```

Box2Df
obb2d_boxf(const OBB2Df *obb);

Box2Dd
obb2d_boxd(const OBB2Dd *obb);

Box2D
OBB2D::box(const OBB2D *obb);

```

obb The box.

Return:

Box aligned with the axes, defined by the minimum and maximum vectors.

tri2d

Triangle from its coordinates.

```

Tri2Df
tri2df(const real32_t x0,
       const real32_t y0,
       const real32_t x1,
       const real32_t y1,
       const real32_t x2,
       const real32_t y2);

Tri2Dd
tri2dd(const real64_t x0,
       const real64_t y0,
       const real64_t x1,
       const real64_t y1,
       const real64_t x2,
       const real64_t y2);

```

```

        const real64_t y2);

Tri2D
Tri2D(const real x0,
      const real y0,
      const real x1,
      const real y1,
      const real x2,
      const real y2);

```

- x0 X coordinate of the first point.
- y0 Y coordinate of the first point.
- x1 X coordinate of the second point.
- y1 Y coordinate of the second point.
- x2 X coordinate of the third point.
- y2 Y coordinate of the third point.

Return:

The triangle.

tri2d_v

Triangle from three points.

```

Tri2Df
tri2d_vf(const V2Df *p0,
         const V2Df *p1,
         const V2Df *p2);

Tri2Dd
tri2d_vd(const V2Dd *p0,
         const V2Dd *p1,
         const V2Dd *p2);

Tri2D
Tri2D::v(const V2D *p0,
        const V2D *p1,
        const V2D *p2);

```

- p0 First point.
- p1 Second point.
- p2 Third point.

Return:

The triangle.

tri2d_transform

Apply a transformation to the triangle.

```
void
tri2d_transformf(Tri2Df *tri,
                 const T2Df *t2d);

void
tri2d_transformd(Tri2Dd *tri,
                 const T2Dd *t2d);

void
Tri2D::transform(Tri2D *tri,
                 const T2D *t2d);
```

tri The triangle.

t2d Affine transformation.

tri2d_area

Gets the area of the triangle.

```
real32_t
tri2d_areaf(const Tri2Df *tri);

real64_t
tri2d_aread(const Tri2Dd *tri);

real
Tri2D::area(const Tri2D *tri);
```

tri The triangle.

Return:

The area.

tri2d_ccw

Obtains the order of the travel of the points of the triangle.

```
bool_t
tri2d_ccwf(const Tri2Df *tri);

bool_t
tri2d_ccwd(const Tri2Dd *tri);
```

```
bool_t
Tri2D::ccw(const Tri2D *tri);
```

tri The triangle.

Return:

TRUE counter-clockwise sense. **FALSE** *clockwise*.

Remarks:

See “*CW and CCW angles*” (page 246).

tri2d_centroid

Gets the centroid (center of mass) of the triangle.

```
V2Df
tri2d_centroidf(const Tri2Df *tri);

V2Dd
tri2d_centroidd(const Tri2Dd *tri);

V2D
Tri2D::centroid(const Tri2D *tri);
```

tri The triangle.

Return:

Center of mass.

pol2d_create

Create a new polygon.

```
Pol2Df*
pol2d_createf(const V2Df *points,
             const uint32_t n);

Pol2Dd*
pol2d_created(const V2Dd *points,
             const uint32_t n);

Pol2D*
Pol2D::create(const V2D *points,
             const uint32_t n);
```

points List of points that make up the polygon.
 n Number of points.

Return:

The polygon created.

pol2d_convex_hull

Creates the minimum convex polygon that surrounds a set of points (*Convex Hull*).

```
Pol2Df*
pol2d_convex_hullf(const V2Df *points,
                  const uint32_t n);

Pol2Dd*
pol2d_convex_hulld(const V2Dd *points,
                  const uint32_t n);

Pol2D*
Pol2D::convex_hull(const V2D *points,
                  const uint32_t n);
```

points Points list.
 n Number of points.

Return:

The polygon.

pol2d_copy

Create a copy of the polygon.

```
Pol2Df*
pol2d_copyf(const Pol2Df *pol);

Pol2Dd*
pol2d_copyd(const Pol2Dd *pol);

Pol2D*
Pol2D::copy(const Pol2D *pol);
```

pol The original polygon.

Return:

The copy.

pol2d_destroy

Destroy the polygon.

```
void
pol2d_destroyf(Pol2Df **pol);

void
pol2d_destroyd(Pol2Dd **pol);

void
Pol2D::destroy(Pol2D **pol);
```

pol The polygon. Will be set to `NULL` after destruction.

pol2d_transform

Apply a 2D transformation.

```
void
pol2d_transformf(Pol2Df *pol,
                 const T2Df *t2d);

void
pol2d_transformd(Pol2Dd *pol,
                 const T2Dd *t2d);

void
Pol2D::transform(Pol2D *pol,
                 const T2D *t2d);
```

pol The polygon.

t2d 2D transformation.

Remarks:

The polygon does not save the original coordinates. Successive transformations will accumulate.

pol2d_points

Gets the vertices that make up the polygon.

```
const V2Df*
pol2d_pointsf(const Pol2Df *pol);

const V2Dd*
pol2d_pointsd(const Pol2Dd *pol);

const V2D*
```

```
Pol2D::points(const Pol2D *pol);
```

pol The polygon.

Return:

Pointer to an array of vertices.

Remarks:

Do not modify the returned array. Copy if necessary.

pol2d_n

Gets the number of vertices that make up the polygon.

```
uint32_t
pol2d_nf(const Pol2Df *pol);

uint32_t
pol2d_nd(const Pol2Dd *pol);

uint32_t
Pol2D::n(const Pol2D *pol);
```

pol The polygon.

Return:

The number of vertices.

Remarks:

It is the same value as the one used in the constructor `pol2d_createf`.

pol2d_area

Gets the area of the polygon.

```
real32_t
pol2d_areaf(const Pol2Df *pol);

real64_t
pol2d_aread(const Pol2Dd *pol);

real
Pol2D::area(const Pol2D *pol);
```

pol The polygon.

Return:

The area.

pol2d_box

Gets the geometric limits of the polygon.

```
Box2Df
pol2d_boxf(const Pol2Df *pol);

Box2Dd
pol2d_boxd(const Pol2Dd *pol);

Box2D
Pol2D::box(const Pol2D *pol);
```

pol The polygon.

Return:

Box aligned with the axes, defined by the minimum and maximum vectors.

pol2d_ccw

Gets the winding order of the polygon points.

```
bool_t
pol2d_ccwf(const Pol2Df *pol);

bool_t
pol2d_ccwd(const Pol2Dd *pol);

bool_t
Pol2D::ccw(const Pol2D *pol);
```

pol The polygon.

Return:

TRUE counter-clockwise. **FALSE** clockwise.

pol2d_convex

Gets whether or not the polygon is convex.

```
bool_t
pol2d_convexf(const Pol2Df *pol);

bool_t
```

```

pol2d_convexd(const Pol2Dd *pol);

bool_t
Pol2D::convex(const Pol2D *pol);

```

pol The polygon.

Return:

TRUE if is convex. FALSE if no.

pol2d_centroid

Gets the centroid (center of mass) of the polygon.

```

V2Df
pol2d_centroidf(const Pol2Df *pol);

V2Dd
pol2d_centroidd(const Pol2Dd *pol);

V2D
Pol2D::centroid(const Pol2D *pol);

```

pol The polygon.

Return:

Center of mass.

pol2d_visual_center

Gets the visual center or label point.

```

V2Df
pol2d_visual_centerf(const Pol2Df *pol);

V2Dd
pol2d_visual_centerd(const Pol2Dd *pol);

V2D
Pol2D::visual_center(const Pol2D *pol);

```

pol The polygon.

Return:

The labeling center.

Remarks:

It corresponds to a point within the polygon located at a maximum distance from any edge. In convex polygons it will coincide with the centroid. It implements an adaptation of the **polylabel** algorithm of the project MapBox¹.

pol2d_triangles

Gets a list of triangles that make up the polygon.

```
ArrSt(Tri2Df)*
pol2d_trianglesf(const Pol2Df *pol);

ArrSt(Tri2Df)*
pol2d_trianglesd(const Pol2Dd *pol);

ArrSt(Tri2Df)*
Pol2D::triangles(const Pol2D *pol);
```

pol The polygon.

Return:

Triangle array. Must be destroyed with `arrst_destroy(&triangles, NULL, Tri2Df)`.

Remarks:

The union of all the triangles corresponds to the original polygon.

pol2d_convex_partition

Gets a list of the convex polygons that make up the polygon.

```
ArrSt(Pol2Df)*
pol2d_convex_partitionf(const Pol2Df *pol);

ArrSt(Pol2Df)*
pol2d_convex_partitiond(const Pol2Dd *pol);

ArrSt(Pol2Df)*
Pol2D::convex_partition(const Pol2D *pol);
```

pol The polygon.

Return:

Array of convex polygons. It must be destroyed with `arrst_destroy(&polys, pol2d_destroyf, Pol2Df)`.

¹<https://github.com/mapbox/polylabel>

Remarks:

The union of all polygons corresponds to the original polygon.

col2d_point_point

Point-point collision.

```
bool_t
col2d_point_pointf(const V2Df *pnt1,
                  const V2Df *pnt2,
                  const real32_t tol,
                  Col2Df *col);

bool_t
col2d_point_pointd(const V2Dd *pnt1,
                  const V2Dd *pnt2,
                  const real64_t tol,
                  Col2Dd *col);

bool_t
Col2D::point_point(const V2D *pnt1,
                  const V2D *pnt2,
                  const real tol,
                  Col2D *col);
```

pnt1 First point.

pnt2 Second point.

tol Tolerance. Minimum distance to be considered a collision.

col Detailed data of the collision. It can be **NULL** if we don't need additional information.

Return:

TRUE if the objects intersect, **FALSE** otherwise.

col2d_segment_point

Segment-point collision.

```
bool_t
col2d_segment_pointf(const Seg2Df *seg,
                    const V2Df *pnt,
                    const real32_t tol,
                    Col2Df *col);

bool_t
col2d_segment_pointd(const Seg2Dd *seg,
```

```

        const V2Dd *pnt,
        const real64_t tol,
        Col2Dd *col);

bool_t
Col2D::segment_point(const Seg2D *seg,
                    const V2D *pnt,
                    const real_t tol,
                    Col2D *col);

```

seg Segment.

pnt Point.

tol Tolerance. Minimum distance to be considered a collision.

col Detailed data of the collision. It can be `NULL` if we don't need additional information.

Return:

`TRUE` if the objects intersect, `FALSE` otherwise.

col2d_segment_segment

Segment-segment collision.

```

bool_t
col2d_segment_segmentf(const Seg2Df *seg1,
                      const Seg2Df *seg2,
                      Col2Df *col);

bool_t
col2d_segment_segmentd(const Seg2Dd *seg1,
                      const Seg2Dd *seg2,
                      Col2Dd *col);

bool_t
Col2D::segment_segment(const Seg2D *seg1,
                      const Seg2D *seg2,
                      Col2D *col);

```

seg1 First segment.

seg2 Second segment.

col Detailed data of the collision. It can be `NULL` if we don't need additional information.

Return:

`TRUE` if the objects intersect, `FALSE` otherwise.

col2d_circle_point

Circle-point collision.

```

bool_t
col2d_circle_pointf(const Cir2Df *cir,
                   const V2Df *pnt,
                   Col2Df *col);

bool_t
col2d_circle_pointd(const Cir2Dd *cir,
                   const V2Dd *pnt,
                   Col2Dd *col);

bool_t
Col2D::circle_point(const Cir2D *cir,
                   const V2D *pnt,
                   Col2D *col);

```

cir Circle.

pnt Point.

col Detailed data of the collision. It can be `NULL` if we don't need additional information.

Return:

`TRUE` if the objects intersect, `FALSE` otherwise.

col2d_circle_segment

Circle-segment collision.

```

bool_t
col2d_circle_segmentf(const Cir2Df *cir,
                    const Seg2Df *seg,
                    Col2Df *col);

bool_t
col2d_circle_segmentd(const Cir2Dd *cir,
                    const Seg2Dd *seg,
                    Col2Dd *col);

bool_t
Col2D::circle_segment(const Cir2D *cir,
                    const Seg2D *seg,
                    Col2D *col);

```

- cir Circle.
- seg Segment.
- col Detailed data of the collision. It can be `NULL` if we don't need additional information.

Return:

`TRUE` if the objects intersect, `FALSE` otherwise.

col2d_circle_circle

Circle-circle collision.

```
bool_t
col2d_circle_circlef(const Cir2Df *cir1,
                    const Cir2Df *cir2,
                    Col2Df *col);

bool_t
col2d_circle_circled(const Cir2Dd *cir1,
                    const Cir2Dd *cir2,
                    Col2Dd *col);

bool_t
Col2D::circle_circle(const Cir2D *cir1,
                    const Cir2D *cir2,
                    Col2D *col);
```

- cir1 First circle.
- cir2 Second circle.
- col Detailed data of the collision. It can be `NULL` if we don't need additional information.

Return:

`TRUE` if the objects intersect, `FALSE` otherwise.

col2d_box_point

Box-point collision.

```
bool_t
col2d_box_pointf(const Box2Df *box,
                const V2Df *pnt,
                Col2Df *col);

bool_t
```

```
col2d_box_pointd(const Box2Dd *box,
                 const V2Dd *pnt,
                 Col2Dd *col);

bool_t
Col2D::box_point(const Box2D *box,
                 const V2D *pnt,
                 Col2D *col);
```

box Box.

pnt Point.

col Detailed data of the collision. It can be `NULL` if we don't need additional information.

Return:

`TRUE` if the objects intersect, `FALSE` otherwise.

col2d_box_segment

Box-segment collision.

```
bool_t
col2d_box_segmentf(const Box2Df *box,
                  const Seg2Df *seg,
                  Col2Df *col);

bool_t
col2d_box_segmentd(const Box2Dd *box,
                  const Seg2Dd *seg,
                  Col2Dd *col);

bool_t
Col2D::box_segment(const Box2D *box,
                  const Seg2D *seg,
                  Col2D *col);
```

box Box.

seg Segment.

col Detailed data of the collision. It can be `NULL` if we don't need additional information.

Return:

`TRUE` if the objects intersect, `FALSE` otherwise.

col2d_box_circle

Box-circle collision.

```
bool_t
col2d_box_circlef(const Box2Df *box,
                  const Cir2Df *cir,
                  Col2Df *col);

bool_t
col2d_box_circled(const Box2Dd *box,
                  const Cir2Dd *cir,
                  Col2Dd *col);

bool_t
Col2D::box_circle(const Box2D *box,
                  const Cir2D *cir,
                  Col2D *col);
```

box Box.

cir Circle.

col Detailed data of the collision. It can be `NULL` if we don't need additional information.

Return:

`TRUE` if the objects intersect, `FALSE` otherwise.

col2d_box_box

Box-box collision.

```
bool_t
col2d_box_boxf(const Box2Df *box1,
               const Box2Df *box2,
               Col2Df *col);

bool_t
col2d_box_boxd(const Box2Dd *box1,
               const Box2Dd *box2,
               Col2Dd *col);

bool_t
Col2D::box_box(const Box2D *box1,
               const Box2D *box2,
               Col2D *col);
```

- box1 First box.
- box2 Second box.
- col Detailed data of the collision. It can be `NULL` if we don't need additional information.

Return:

`TRUE` if the objects intersect, `FALSE` otherwise.

col2d_obb_point

Point-oriented box collision.

```
bool_t
col2d_obb_pointf(const OBB2Df *obb,
                const V2Df *pnt,
                Col2Df *col);

bool_t
col2d_obb_pointd(const OBB2Dd *obb,
                const V2Dd *pnt,
                Col2Dd *col);

bool_t
Col2D::obb_point(const OBB2D *obb,
                 const V2D *pnt,
                 Col2D *col);
```

- obb Oriented box.
- pnt Point.
- col Detailed data of the collision. It can be `NULL` if we don't need additional information.

Return:

`TRUE` if the objects intersect, `FALSE` otherwise.

col2d_obb_segment

Segment-oriented box collision.

```
bool_t
col2d_obb_segmentf(const OBB2Df *obb,
                  const Seg2Df *seg,
                  Col2Df *col);

bool_t
```

```

col2d_obb_segmentd(const OBB2Dd *obb,
                  const Seg2Dd *seg,
                  Col2Dd *col);

bool_t
Col2D::obb_segment(const OBB2D *obb,
                  const Seg2D *seg,
                  Col2D *col);

```

obb Oriented box.

seg Segment.

col Detailed data of the collision. It can be `NULL` if we don't need additional information.

Return:

`TRUE` if the objects intersect, `FALSE` otherwise.

col2d_obb_circle

Collision-oriented box-circle.

```

bool_t
col2d_obb_circlef(const OBB2Df *obb,
                 const Cir2Df *cir,
                 Col2Df *col);

bool_t
col2d_obb_circled(const OBB2Dd *obb,
                 const Cir2Dd *cir,
                 Col2Dd *col);

bool_t
Col2D::obb_circle(const OBB2D *obb,
                 const Cir2D *cir,
                 Col2D *col);

```

obb Oriented box.

cir Circle.

col Detailed data of the collision. It can be `NULL` if we don't need additional information.

Return:

`TRUE` if the objects intersect, `FALSE` otherwise.

col2d_obb_box

Box-oriented box collision.

```

bool_t
col2d_obb_boxf(const OBB2Df *obb,
              const Box2Df *box,
              Col2Df *col);

bool_t
col2d_obb_boxd(const OBB2Dd *obb,
              const Box2Dd *box,
              Col2Dd *col);

bool_t
Col2D::obb_box(const OBB2D *obb,
              const Box2D *box,
              Col2D *col);

```

obb Oriented box.

box Aligned box.

col Detailed data of the collision. It can be `NULL` if we don't need additional information.

Return:

`TRUE` if the objects intersect, `FALSE` otherwise.

col2d_obb_obb

Oriented Box-Oriented Box collision.

```

bool_t
col2d_obb_obbf(const OBB2Df *obb1,
              const OBB2Df *obb2,
              Col2Df *col);

bool_t
col2d_obb_obbd(const OBB2Dd *obb1,
              const OBB2Dd *obb2,
              Col2Dd *col);

bool_t
Col2D::obb_obb(const OBB2D *obb1,
              const OBB2D *obb2,
              Col2D *col);

```

- obb1 First oriented box.
- obb2 Second oriented box.
- col Detailed data of the collision. It can be `NULL` if we don't need additional information.

Return:

`TRUE` if the objects intersect, `FALSE` otherwise.

col2d_tri_point

Triangle-point collision.

```
bool_t
col2d_tri_pointf(const Tri2Df *tri,
                const V2Df *pnt,
                Col2Df *col);

bool_t
col2d_tri_pointd(const Tri2Dd *tri,
                const V2Dd *pnt,
                Col2Dd *col);

bool_t
Col2D::tri_point(const Tri2D *tri,
                const V2D *pnt,
                Col2D *col);
```

tri Triangle.

pnt Point.

col Detailed data of the collision. It can be `NULL` if we don't need additional information.

Return:

`TRUE` if the objects intersect, `FALSE` otherwise.

col2d_tri_segment

Triangle-segment collision.

```
bool_t
col2d_tri_segmentf(const Tri2Df *tri,
                  const Seg2Df *seg,
                  Col2Df *col);

bool_t
```

```

col2d_tri_segmentd(const Tri2Dd *tri,
                  const Seg2Dd *seg,
                  Col2Dd *col);

bool_t
Col2D::tri_segment(const Tri2D *tri,
                  const Seg2D *seg,
                  Col2D *col);

```

tri Triangle.

seg Segment.

col Detailed data of the collision. It can be `NULL` if we don't need additional information.

Return:

`TRUE` if the objects intersect, `FALSE` otherwise.

col2d_tri_circle

Triangle-circle collision.

```

bool_t
col2d_tri_circlef(const Tri2Df *tri,
                  const Cir2Df *cir,
                  Col2Df *col);

bool_t
col2d_tri_circled(const Tri2Dd *tri,
                  const Cir2Dd *cir,
                  Col2Dd *col);

bool_t
Col2D::tri_circle(const Tri2D *tri,
                  const Cir2D *cir,
                  Col2D *col);

```

tri Triangle.

cir Circle.

col Detailed data of the collision. It can be `NULL` if we don't need additional information.

Return:

`TRUE` if the objects intersect, `FALSE` otherwise.

col2d_tri_box

Triangle-box collision.

```
bool_t
col2d_tri_boxf(const Tri2Df *tri,
               const Box2Df *box,
               Col2Df *col);

bool_t
col2d_tri_boxd(const Tri2Dd *tri,
               const Box2Dd *box,
               Col2Dd *col);

bool_t
Col2D::tri_box(const Tri2D *tri,
               const Box2D *box,
               Col2D *col);
```

tri Triangle.

box Aligned box.

col Detailed data of the collision. It can be `NULL` if we don't need additional information.

Return:

`TRUE` if the objects intersect, `FALSE` otherwise.

col2d_tri_obb

Triangle-oriented box collision.

```
bool_t
col2d_tri_obbf(const Tri2Df *tri,
               const OBB2Df *obb,
               Col2Df *col);

bool_t
col2d_tri_obbd(const Tri2Dd *tri,
               const OBB2Dd *obb,
               Col2Dd *col);

bool_t
Col2D::tri_obb(const Tri2D *tri,
               const OBB2D *obb,
               Col2D *col);
```

- tri Triangle.
- obb Oriented box.
- col Detailed data of the collision. It can be `NULL` if we don't need additional information.

Return:

`TRUE` if the objects intersect, `FALSE` otherwise.

col2d_tri_tri

Triangle-triangle collision.

```
bool_t
col2d_tri_trif(const Tri2Df *tri1,
              const Tri2Df *tri2,
              Col2Df *col);

bool_t
col2d_tri_trid(const Tri2Dd *tri1,
              const Tri2Dd *tri2,
              Col2Dd *col);

bool_t
Col2D::tri_tri(const Tri2D *tri1,
              const Tri2D *tri2,
              Col2D *col);
```

- tri1 First triangle.
- tri2 Second triangle.
- col Detailed data of the collision. It can be `NULL` if we don't need additional information.

Return:

`TRUE` if the objects intersect, `FALSE` otherwise.

col2d_poly_point

Polygon-point collision.

```
bool_t
col2d_poly_pointf(const Pol2Df *pol,
                 const V2Df *pnt,
                 Col2Df *col);

bool_t
```

```

col2d_poly_pointd(const Pol2Dd *pol,
                  const V2Dd *pnt,
                  Col2Dd *col);

bool_t
Col2D::poly_point(const Pol2D *pol,
                  const V2D *pnt,
                  Col2D *col);

```

pol Polygon.

pnt Point.

col Detailed data of the collision. It can be `NULL` if we don't need additional information.

Return:

`TRUE` if the objects intersect, `FALSE` otherwise.

col2d_poly_segment

Polygon-segment collision.

```

bool_t
col2d_poly_segmentf(const Pol2Df *pol,
                   const Seg2Df *seg,
                   Col2Df *col);

bool_t
col2d_poly_segmentd(const Pol2Dd *pol,
                   const Seg2Dd *seg,
                   Col2Dd *col);

bool_t
Col2D::poly_segment(const Pol2D *pol,
                   const Seg2D *seg,
                   Col2D *col);

```

pol Polygon.

seg Segment.

col Detailed data of the collision. It can be `NULL` if we don't need additional information.

Return:

`TRUE` if the objects intersect, `FALSE` otherwise.

col2d_poly_circle

Polygon-circle collision.

```

bool_t
col2d_poly_circlef(const Pol2Df *pol,
                  const Cir2Df *cir,
                  Col2Df *col);

bool_t
col2d_poly_circled(const Pol2Dd *pol,
                  const Cir2Dd *cir,
                  Col2Dd *col);

bool_t
Col2D::poly_circle(const Pol2D *pol,
                  const Cir2D *cir,
                  Col2D *col);

```

pol Polygon.

cir Circle.

col Detailed data of the collision. It can be `NULL` if we don't need additional information.

Return:

`TRUE` if the objects intersect, `FALSE` otherwise.

col2d_poly_box

Polygon-box collision.

```

bool_t
col2d_poly_boxf(const Pol2Df *pol,
               const Box2Df *cir,
               Col2Df *col);

bool_t
col2d_poly_boxd(const Pol2Dd *pol,
               const Box2Dd *cir,
               Col2Dd *col);

bool_t
Col2D::poly_box(const Pol2D *pol,
               const Box2D *cir,
               Col2D *col);

```

- pol Polygon.
- cir Box.
- col Detailed data of the collision. It can be `NULL` if we don't need additional information.

Return:

`TRUE` if the objects intersect, `FALSE` otherwise.

col2d_poly_obb

Polygon-box collision.

```
bool_t
col2d_poly_obbf(const Pol2Df *pol,
                const OBB2Df *cir,
                Col2Df *col);

bool_t
col2d_poly_obbd(const Pol2Dd *pol,
                const OBB2Dd *cir,
                Col2Dd *col);

bool_t
Col2D::poly_obb(const Pol2D *pol,
                const OBB2D *cir,
                Col2D *col);
```

- pol Polygon.
- cir Oriented box.
- col Detailed data of the collision. It can be `NULL` if we don't need additional information.

Return:

`TRUE` if the objects intersect, `FALSE` otherwise.

col2d_poly_tri

Polygon-triangle collision.

```
bool_t
col2d_poly_trif(const Pol2Df *pol,
                const Tri2Df *tri,
                Col2Df *col);

bool_t
```



```
col2d_poly_trid(const Pol2Dd *pol,
               const Tri2Dd *tri,
               Col2Dd *col);

bool_t
Col2D::poly_tri(const Pol2D *pol,
                const Tri2D *tri,
                Col2D *col);
```

pol Polygon.

tri Triangle.

col Detailed data of the collision. It can be `NULL` if we don't need additional information.

Return:

`TRUE` if the objects intersect, `FALSE` otherwise.

col2d_poly_poly

Polygon-polygon collision.

```
bool_t
col2d_poly_polyf(const Pol2Df *pol1,
                 const Pol2Df *pol2,
                 Col2Df *col);

bool_t
col2d_poly_polyd(const Pol2Dd *pol1,
                 const Pol2Dd *pol2,
                 Col2Dd *col);

bool_t
Col2D::poly_poly(const Pol2D *pol1,
                 const Pol2D *pol2,
                 Col2D *col);
```

pol1 First polygon.

pol2 Second polygon.

col Detailed data of the collision. It can be `NULL` if we don't need additional information.

Return:

`TRUE` if the objects intersect, `FALSE` otherwise.

Draw2D library

42.1. Types and Constants

kCOLOR_TRANSPARENT

Totally transparent color, absence of color or null color.

```
const color_t kCOLOR_TRANSPARENT;
```

kCOLOR_DEFAULT

Default color.

```
const color_t kCOLOR_DEFAULT;
```

kCOLOR_BLACK

BLACK color rgb(0,0,0).

```
const color_t kCOLOR_BLACK;
```

kCOLOR_WHITE

WHITE color rgb(255,255,255).

```
const color_t kCOLOR_WHITE;
```

kCOLOR_RED

RED color rgb(255,0,0).

```
const color_t kCOLOR_RED;
```

kCOLOR_GREEN

GREEN color rgb(0,255,0).

```
const color_t kCOLOR_GREEN;
```

kCOLOR_BLUE

BLUE color rgb(0,0,255).

```
const color_t kCOLOR_BLUE;
```

kCOLOR_YELLOW

YELLOW color rgb(255,255,0).

```
const color_t kCOLOR_YELLOW;
```

kCOLOR_CYAN

CYAN color rgb(0,255,255).

```
const color_t kCOLOR_CYAN;
```

kCOLOR_MAGENTA

MAGENTA color rgb(255,0,255).

```
const color_t kCOLOR_MAGENTA;
```

enum pixformat_t

Pixel format in an image. Number of bits per pixel and color model.

- `eINDEX1` 1 bit per pixel. 2 colors, indexed.
- `eINDEX2` 2 bits per pixel. 4 colors, indexed.
- `eINDEX4` 4 bits per pixel. 16 colors, indexed.
- `eINDEX8` 8 bits per pixel. 256 colors, indexed.
- `eGRAY8` 8 bits per pixel in grayscale. 256 shades of gray.
- `eRGB24` 24 bits per RGB pixel. 8 bits per channel (red, green, blue).
The lowest order byte corresponds to the red one and the highest one to the blue one.

- `ekRGBA32` 32 bits per pixel RGBA. 8 bits per channel (red, green, blue, alpha). The lowest order byte corresponds to the red one and the highest one to alpha (transparency).
- `ekFIMAGE` Represents the original format of the image. Only valid at `image_pixels`.

enum codec_t

Image encoding and compression format.

- `ekJPG` *Joint Photographic Experts Group.*
- `ekPNG` *Portable Network Graphics.*
- `ekBMP` *BitMaP.*
- `ekGIF` *Graphics Interchange Format.*

enum fstyle_t

Style in typographic fonts. Multiple values can be combined with the OR operator ('|').

- `ekFNORMAL` Normal font, no style. Also called *Regular*.
- `ekFBOLD` **Bold** font.
- `ekFITALIC` *Italic* font.
- `ekFSTRIKEOUT` ~~Crossed out~~ font.
- `ekFUNDERLINE` Underlined font.
- `ekFSUBSCRIPT` Subscript. See `textview_fstyle`.
- `ekFSUPSCRIPT` Superscript. See `textview_fstyle`.
- `ekFPIXELS` Font sizes will be indicated in pixels.
- `ekFPOINTS` Font sizes will be indicated in points. “*Size in points*” (page 300).

enum linecap_t

Line end style.

- `ekLCFLAT` Flat termination at the last point of the line.
- `ekLCSQUARE` Termination in a box, whose center is the last point of the line.

`ekLCROUND` Termination in a circle, whose center is the last point of the line.

enum linejoin_t

Line junction style.

`ekLJMITER` Union at an angle. In very closed angles it is trimmed.

`ekLJROUND` Rounded union.

`ekLJBEVEL` Beveled union.

enum fillwrap_t

Behavior of the fill pattern in the limits.

`ekFCLAMP` The last limit value is used to fill the outside area.

`ekFTILE` Pattern is repeated.

`ekFFLIP` The pattern is repeated, reversing the order.

enum drawop_t

Operation to be performed on graphic primitives.

`ekSTROKE` Draw the outline of the figure with the default line style.

`ekFILL` Fill the figure area with the default color or pattern.

`ekSKFILL` First draw the outline and then fill in.

`ekFILLSK` First fill in and then draw the outline.

enum align_t

Alignment values.

`ekLEFT` Alignment to the left margin.

`ekTOP` Alignment to the upper margin.

`ekCENTER` Centered alignment.

`ekRIGHT` Alignment to the right margin.

`ekBOTTOM` Alignment to the lower margin.

`ekJUSTIFY` Justification or expansion of content.

enum ellipsis_t

Position of the ellipsis (...) when clipping a text.

<code>ekELLIPNONE</code>	Without ellipsis.
<code>ekELLIPBEGIN</code>	Ellipsis at the beginning of the text.
<code>ekELLIPMIDDLE</code>	Ellipsis in the center of the text.
<code>ekELLIPEND</code>	Ellipsis at the end of the text.
<code>ekELLIPMLINE</code>	Multi-line text (without ellipsis).

struct color_t

32-bit integer representing an RGBA color. The lowest order byte corresponds to the red channel (Red) and the highest order to the Alpha channel (transparency). “Colors” (page 285).

```
struct color_t;
```

struct DCtx

2D drawing context, recipient for drawing commands. It is also known as canvas or surface. “2D Contexts” (page 265).

```
struct DCtx;
```

struct Draw

Drawing geometric entities.

```
struct Drawf;
```

```
struct Drawd;
```

```
struct Draw;
```

struct Palette

Color palette, usually related to indexed `Pixbuf`. “Palettes” (page 287).

```
struct Palette;
```

struct Pixbuf

In-memory buffer with pixel information. “*Pixel Buffer*” (page 288).

```
struct Pixbuf;
```

struct Image

Represents a bitmap image, composed of pixels. “*Images*” (page 291).

```
struct Image;
```

struct Font

Represents a typographic family, size and style with which the texts will be drawn. “*Fonts*” (page 296).

```
struct Font;
```

42.2. Functions

draw2d_start

Start the *draw2d* library, reserving space for global internal structures. Internally call `core_start`. In desktop applications, `osmain` call this function when starting the program.

```
void
draw2d_start(void);
```

draw2d_finish

Ends the *draw2d* library, freeing up the space of the global internal structures. Internally call `core_finish`. In desktop applications, `osmain` call this function when exiting the program.

```
void
draw2d_finish(void);
```

resid_image

Makes a casting ResId-Image.

```
const Image*
resid_image(const ResId id);
```

id The resource Id.

Return:

The Image Id.

dctx_bitmap

Create a memory context, in order to generate an image.

```
Dctx*
dctx_bitmap(const uint32_t width,
            const uint32_t height,
            const pixformat_t format);
```

width Image width in pixels.

height Image height in pixels.

format Pixel format of the generated image.

Return:

Drawing context.

Remarks:

When we finish drawing, we must call `dctx_image` to get the picture.

dctx_image

Get the result image after drawing in the context created with `dctx_bitmap`.

```
Image*
dctx_image(Dctx **ctx);
```

ctx The context, which will be destroyed after generating the image.

Return:

The image.

draw_clear

Clears the entire context area, using a solid color.

```
void
draw_clear(Dctx *ctx,
           const color_t color);
```

ctx Drawing context.

color Background color.

draw_matrix

Set the context reference system (affine transformation).

```
void
draw_matrixf(DCtx *ctx,
             const T2Df *t2d);

void
draw_matrixd(DCtx *ctx,
             const T2Dd *t2d);

void
Draw::matrix(DCtx *ctx,
             const T2D *t2d);
```

ctx Drawing context.

t2d Transformation.

Remarks:

The origin of coordinates is in the upper left corner. The Y axis increases down.

draw_matrix_cartesian

Set the reference system in Cartesian coordinates.

```
void
draw_matrix_cartesianf(DCtx *ctx,
                      const T2Df *t2d);

void
draw_matrix_cartesiand(DCtx *ctx,
                      const T2Dd *t2d);

void
Draw::matrix_cartesian(DCtx *ctx,
                      const T2D *t2d);
```

ctx Drawing context.

t2d Transformation.

Remarks:

The origin of coordinates is in the lower left corner. The Y axis increases upwards. See “*Cartesian systems*” (page 270).

draw_antialias

Enable or disable antialiasing.

```
void
draw_antialias(DCtx *ctx,
               const bool_t on);
```

ctx Drawing context.

on TRUE active, FALSE inactive.

Remarks:

The antialias can change in each primitive. It is not necessary to establish a policy for the whole drawing. See “*Antialiasing*” (page 271).

draw_line

Draw a line.

```
void
draw_line(DCtx *ctx,
          const real32_t x0,
          const real32_t y0,
          const real32_t x1,
          const real32_t y1);
```

ctx Drawing context.

x0 X coordinate of the first point.

y0 Y coordinate of the first point.

x1 X coordinate of the second point.

y1 Y coordinate of the second point.

draw_polyline

Draw several joined lines.

```
void
draw_polyline(DCtx *ctx,
              const bool_t closed,
              const V2Df *points,
              const uint32_t n);
```

- ctx Drawing context.
- closed **TRUE** to join the last point with the first.
- points Array of points that compose the polyline.
- n Number of points.

draw_arc

Draw an arc (circle segment).

```
void
draw_arc(DCtx *ctx,
         const real32_t x,
         const real32_t y,
         const real32_t radius,
         const real32_t start,
         const real32_t sweep);
```

- ctx Drawing context.
- x X coordinate of the arc center.
- y Y coordinate of the arc center.
- radius Arc radius.
- start Initial angle with respect to the vector $X=[1, 0]$ in radians.
- sweep Sweep angle or arc size in radians.

Remarks:

Positive angles are those that rotate from vector X to vector Y. See “2D Vectors” (page 245).

draw_bezier

Draw a cubic Bézier curve (degree 3) using two endpoints (x_0,y_0) - (x_3,y_3) and two intermediate control points (x_1,y_1) - (x_2,y_2) .

```
void
draw_bezier(DCtx *ctx,
            const real32_t x0,
            const real32_t y0,
            const real32_t x1,
            const real32_t y1,
            const real32_t x2,
            const real32_t y2,
            const real32_t x3,
            const real32_t y3);
```

- ctx Drawing context.
- x0 X coordinate of the starting point.
- y0 Y coordinate of the starting point.
- x1 X coordinate of the first intermediate point.
- y1 Y coordinate of the first intermediate point.
- x2 X coordinate of the second intermediate point.
- y2 Y coordinate of the second intermediate point.
- x3 X coordinate of end point.
- y3 Y coordinate of the end point.

draw_line_color

Set the color of drawing lines and contours.

```
void
draw_line_color(DCtx *ctx,
                const color_t color);
```

- ctx Drawing context.
- color Line color.

draw_line_fill

Sets the current fill pattern for line drawing.

```
void
draw_line_fill(DCtx *ctx);
```

- ctx Drawing context.

Remarks:

The fill pattern must have been previously set by `draw_fill_linear`. See “*Gradients in lines*” (page 278).

draw_line_width

Set the line thickness.

```
void
draw_line_width(DCtx *ctx,
                const real32_t width);
```

ctx Drawing context.
width Line width.

draw_line_cap

Set the style of the line ends.

```
void
draw_line_cap(DCtx *ctx,
              const linecap_t cap);
```

ctx Drawing context.
cap Style.

draw_line_join

Set the style of line junctions.

```
void
draw_line_join(DCtx *ctx,
               const linejoin_t join);
```

ctx Drawing context.
join Union style.

draw_line_dash

Set a pattern for line drawing.

```
void
draw_line_dash(DCtx *ctx,
               const real32_t *pattern,
               const uint32_t n);
```

ctx Drawing context.
pattern Array of values that define the pattern.
n Number of values.

Remarks:

The first element of `pattern` defines the length of the first stroke and the second of the first hole, so on. Lengths are scaled by line width `draw_line_width`, that is, a stroke of length 1 will draw a square of side `line_width`. Lengths of value 2 equal to twice the line thickness, etc. The pattern will scale proportionally when changing the thickness or zooming through transformations.

draw_rect

Draw a rectangle.

```
void
draw_rect(DCtx *ctx,
          const drawop_t op,
          const real32_t x,
          const real32_t y,
          const real32_t width,
          const real32_t height);
```

ctx Drawing context.

op Drawing operation.

x X coordinate of the upper left corner of the rectangle.

y Y coordinate of the upper left corner of the rectangle.

width Rectangle width.

height Rectangle height.

Remarks:

In “*Cartesian systems*” (page 270) (x,y) indicate the origin of the lower left corner.

draw_rndrect

Draw a rectangle with rounded edges.

```
void
draw_rndrect(DCtx *ctx,
            const drawop_t op,
            const real32_t x,
            const real32_t y,
            const real32_t width,
            const real32_t height,
            const real32_t radius);
```

ctx Drawing context.

op Drawing operation.

x X coordinate of the upper left corner of the rectangle.

y Y coordinate of the upper left corner of the rectangle.

width Rectangle width.

height Rectangle height.

radius Corner curvature radius.

Remarks:

In “*Cartesian systems*” (page 270) (x,y) indicate the origin of the lower left corner.

draw_circle

Draw a circle.

```
void
draw_circle(DCtx *ctx,
            const drawop_t op,
            const real32_t x,
            const real32_t y,
            const real32_t radius);
```

ctx Drawing context.

op Drawing operation.

x X coordinate of the center.

y Y coordinate of the center.

radius Radius.

draw_ellipse

Draw an ellipse.

```
void
draw_ellipse(DCtx *ctx,
             const drawop_t op,
             const real32_t x,
             const real32_t y,
             const real32_t radx,
             const real32_t rady);
```

ctx Drawing context.

op Drawing operation.

x X coordinate of the center.

y Y coordinate of the center.

radx X axis radius.

rady Y axis radius.

draw_polygon

Draw a polygon.

```

void
draw_polygon(DCtx *ctx,
             const drawop_t op,
             const V2Df *points,
             const uint32_t n);

```

- ctx Drawing context.
- op Drawing operation.
- points Array of points that form the polygon.
- n Number of points.

draw_fill_color

Set a solid color for area filling.

```

void
draw_fill_color(DCtx *ctx,
               const color_t color);

```

- ctx Drawing context.
- color Fill color.

draw_fill_linear

Set a gradient for filling areas.

```

void
draw_fill_linear(DCtx *ctx,
               const color_t *color,
               const real32_t *stop,
               const uint32_t n,
               const real32_t x0,
               const real32_t y0,
               const real32_t x1,
               const real32_t y1);

```

ctx Drawing context.
 color Color array.
 stop Color positions.
 n Number of positions/colors.
 x0 X coordinate of the starting point.
 y0 Y coordinate of the starting point.
 x1 X coordinate of the end point.
 y1 Y coordinate of the end point.

Remarks:

The positions must go from the value 0 to 1. See “*Gradients*” (page 275).

draw_fill_matrix

Sets the transformation matrix of the fill pattern.

```
void
draw_fill_matrix(DCtx *ctx,
                const T2Df *t2d);
```

ctx Drawing context.
 t2d Transformation.

Remarks:

It will only be effective in non-solid fills. See “*Gradients*” (page 275).

draw_fill_wrap

Set the behavior of the gradient or fill pattern to the limits.

```
void
draw_fill_wrap(DCtx *ctx,
               const fillwrap_t wrap);
```

ctx Drawing context.
 wrap Behavior at the edge.

Remarks:

It will only be effective in non-solid fills. See “*Gradients*” (page 275).

draw_font

Set the font for text drawing.

```
void
draw_font(DCtx *ctx,
          const Font *font);
```

ctx Drawing context.

font Fuente tipográfica.

Remarks:

Tendrá efecto a partir del siguiente texto dibujado. Ver “*Fonts*” (page 296).

draw_text_color

Sets the text color.

```
void
draw_text_color(DCtx *ctx,
                const color_t color);
```

ctx Drawing context.

color Color.

draw_text

Draw a block of text.

```
void
draw_text(DCtx *ctx,
          const char_t *text,
          const real32_t x,
          const real32_t y);
```

ctx Drawing context.

text UTF8 string, terminated in a null character '\0'.

x X coordinate on the canvas of the text origin.

y Y coordinate on the canvas of the text origin.

Remarks:

The text will be drawn with the font and preset style and will be sensitive to the context transformation. See “*Drawing text*” (page 279).

draw_text_path

Draw a block of text as a geometric area. Similar to `draw_text`, but allows you to use gradients or draw only the border of the text.

```
void
draw_text_path(DCtx *ctx,
               const drawop_t op,
               const char_t *text,
               const real32_t x,
               const real32_t y);
```

ctx Drawing context.

op Drawing operation.

text UTF8 string, null-terminated '\0'.

x X coordinate on the canvas of the text origin.

y Y coordinate on canvas of text origin.

Remarks:

The text will be drawn with the preset font and style (fill and line) and will be context sensitive. See “*Drawing text*” (page 279).

draw_text_width

Set the maximum width of the text blocks.

```
void
draw_text_width(DCtx *ctx,
                const real32_t width);
```

ctx Drawing context.

width Maximum width.

Remarks:

If the text to draw with `draw_text` is wider than `width`, it will fragment into several lines. Pass -1 to draw the entire block on a single line. Context scaling is not taken into account. The measurement is made based on the size of the preset font. See “*Drawing text*” (page 279).

draw_text_trim

Sets how the text will be trimmed when it is wider than the value of `draw_text_width`.

```
void
draw_text_trim(DCtx *ctx,
               const ellipsis_t ellipsis);
```

ctx Drawing context.

ellipsis Trim style.

draw_text_align

Sets the alignment of the text with respect to the insertion point.

```
void
draw_text_align(DCtx *ctx,
                const align_t halign,
                const align_t valign);
```

ctx Drawing context.

halign Horizontal alignment.

valign Vertical alignment.

Remarks:

The insertion point is the coordinate (x, y) from `draw_text`. See “*Drawing text*” (page 279).

draw_text_halign

Set the internal horizontal alignment of the text, within a multi-line block.

```
void
draw_text_halign(DCtx *ctx,
                 const align_t halign);
```

ctx Drawing context.

halign Horizontal alignment.

Remarks:

In single-line texts, it has no effect. See “*Drawing text*” (page 279).

draw_text_extents

Calculate the size of a block of text.

```

void
draw_text_extents(DCtx *ctx,
                  const char_t *text,
                  const real32_t refwidth,
                  real32_t *width,
                  real32_t *height);

```

ctx Drawing context.

text Text.

refwidth Reference width.

width Block width.

height Block height.

Remarks:

If `refwidth` is greater than 0, `width` will be bounded by this value and `height` will expand to accommodate all the text. Take into account possible new lines `'\n'` from text.

draw_image

Draw a image.

```

void
draw_image(DCtx *ctx,
           const Image *image,
           const real32_t x,
           const real32_t y);

```

ctx Drawing context.

image The image to draw.

x X coordinate on the canvas of the image origin.

y Y coordinate on the canvas of the image origin.

Remarks:

The image will be drawn at its natural size and in the indicated position. Use `draw_matrixf` to perform scaling and rotation. See “*Drawing images*” (page 282).

draw_image_frame

Like `draw_image`, but indicating the sequence number of an animation.

```

void
draw_image_frame(DCtx *ctx,
                 const Image *image,
                 const uint32_t frame,
                 const real32_t x,
                 const real32_t y);

```

- ctx Drawing context.
- image The image to draw.
- frame Sequence index (*frame*) of the animation.
- x X coordinate on the canvas of the image origin.
- y Y coordinate on the canvas of the image origin.

Remarks:

Only images created from a **GIF** file support multiple frames (animations). See `image_num_frames`.

draw_image_align

Sets the alignment of the image with respect to the insertion point.

```

void
draw_image_align(DCtx *ctx,
                 const align_t halign,
                 const align_t valign);

```

- ctx Drawing context.
- halign Horizontal alignment.
- valign Vertical alignment.

Remarks:

The insertion point is the coordinate (x, y) from `draw_image`. See “*Drawing images*” (page 282).

draw_v2d

Draw a 2D point.

```

void
draw_v2df(DCtx *ctx,
           const drawop_t op,
           const V2Df *v2d,
           const real32_t radius);

```

```

void
draw_v2dd(DCtx *ctx,
          const drawop_t op,
          const V2Dd *v2d,
          const real64_t radius);

void
Draw::v2d(DCtx *ctx,
          const drawop_t op,
          const V2D *v2d,
          const real radius);

```

ctx Drawing context.

op Drawing operation.

v2d Point.

radius Radius.

draw_seg2d

Draw a 2D segment.

```

void
draw_seg2df(DCtx *ctx,
            const Seg2Df *seg);

void
draw_seg2dd(DCtx *ctx,
            const Seg2Dd *seg);

void
Draw::seg2d(DCtx *ctx,
            const Seg2D *seg);

```

ctx Drawing context.

seg Segment.

draw_cir2d

Draw a 2D circle.

```

void
draw_cir2df(DCtx *ctx,
            const drawop_t op,
            const Cir2Df *cir);

void

```

```

draw_cir2dd(DCtx *ctx,
            const drawop_t op,
            const Cir2Dd *cir);

void
Draw::cir2d(DCtx *ctx,
            const drawop_t op,
            const Cir2D *cir);

```

ctx Drawing context.
 op Drawing operation.
 cir Circle.

draw_box2d

Draw a 2D box.

```

void
draw_box2df(DCtx *ctx,
            const drawop_t op,
            const Box2Df *box);

void
draw_box2dd(DCtx *ctx,
            const drawop_t op,
            const Box2Dd *box);

void
Draw::box2d(DCtx *ctx,
            const drawop_t op,
            const Box2D *box);

```

ctx Drawing context.
 op Drawing operation.
 box Aligned box.

draw_obb2d

Draw an oriented 2D box.

```

void
draw_obb2df(DCtx *ctx,
            const drawop_t op,
            const OBB2Df *obb);

void
draw_obb2dd(DCtx *ctx,

```



```

        const drawop_t op,
        const OBB2Dd *obb);

void
Draw::obb2d(DCtx *ctx,
            const drawop_t op,
            const OBB2D *obb);

```

ctx Drawing context.

op Drawing operation.

obb Oriented box.

draw_tri2d

Draw a 2D triangle.

```

void
draw_tri2df(DCtx *ctx,
            const drawop_t op,
            const Tri2Df *tri);

void
draw_tri2dd(DCtx *ctx,
            const drawop_t op,
            const Tri2Dd *tri);

void
Draw::tri2d(DCtx *ctx,
            const drawop_t op,
            const Tri2D *tri);

```

ctx Drawing context.

op Drawing operation.

tri Triangle.

draw_pol2d

Draw a 2D polygon.

```

void
draw_pol2df(DCtx *ctx,
            const drawop_t op,
            const Pol2Df *pol);

void
draw_pol2dd(DCtx *ctx,
            const drawop_t op,

```

```

        const Pol2Dd *pol);

void
Draw::pol2d(DCtx *ctx,
            const drawop_t op,
            const Pol2D *pol);

```

ctx Drawing context.
 op Drawing operation.
 pol Polygon.

color_rgb

Create a color from the channels **R** (red), **G** (green) y **B** (blue).

```

color_t
color_rgb(const uint8_t r,
          const uint8_t g,
          const uint8_t b);

```

r Red channel.
 g Green channel.
 b Blue channel.

Return:

Color.

Remarks:

The alpha channel is set to 255 (totally opaque).

color_rgba

Create a color from the channels **R** (red), **G** (green), **B** (blue) and **A** (alpha).

```

color_t
color_rgba(const uint8_t r,
           const uint8_t g,
           const uint8_t b,
           const uint8_t a);

```

- r Red channel.
- g Green channel.
- b Blue channel.
- a Alpha channel (transparency).

Return:

Color.

Remarks:

a=0 not supported. Use `KCOLOR_TRANSPARENT` in those cases.

color_rgbaf

Create a color from the normalized RGBA channels from 0 to 1.

```
color_t  
color_rgbaf(const real32_t r,  
            const real32_t g,  
            const real32_t b,  
            const real32_t a);
```

- r Red channel.
- g Green channel.
- b Blue channel.
- a Alpha channel (transparency).

Return:

Color.

Remarks:

a=0 not supported. Use `KCOLOR_TRANSPARENT` in those cases.

color_hsb

Creates a color (rgb) from its components Hue-Saturation-Brightness.

```
color_t  
color_hsb(const real32_t hue,  
          const real32_t sat,  
          const real32_t bright);
```

hue Hue component.
 sat Saturation component.
 bright Brightness component.

Return:

Color.

color_red

Create an RGB color using only the red channel.

```
color_t
color_red(const uint8_t r);
```

r Red Channel.

Return:

Color.

Remarks:

Equivalent to `color_rgb(r, 0, 0)`.

color_green

Create an RGB color using only the green channel.

```
color_t
color_green(const uint8_t g);
```

g Green channel.

Return:

Color.

Remarks:

Equivalent to `color_rgb(0, g, 0)`.

color_blue

Create an RGB color using only the blue channel.

```
color_t
color_blue(const uint8_t b);
```

b Blue channel.

Return:

Color.

Remarks:

Equivalent to `color_rgb(0, 0, b)`.

color_gray

Creates a gray RGB color from intensity value.

```
color_t  
color_gray(const uint8_t l);
```

l Intensity (luminance).

Return:

Color.

Remarks:

Equivalent to `color_rgb(1, 1, 1)`.

color_bgr

Create a color from a 32-bit BGR value. Byte 0 corresponds to channel **B**, 1 to **G** and 2 to **R**. The highest order byte is ignored (set to 255).

```
color_t  
color_bgr(const uint32_t bgr);
```

bgr The bgr 32bits value.

Return:

Color.

Remarks:

This byte order is typical in Web colors.

color_html

Create a color from a string in HTML or CSS format.

```
color_t
color_html(const char_t *html);
```

```
color_t c1 = color_html("#FF0000"); // Red
color_t c2 = color_html("#000080"); // Navy
```

html The text string with the HTML color.

Return:

The color transformed to RGB.

color_to_hsb

Convert a color (rgb) to HSB space (hue, saturation, brightness).

```
void
color_to_hsb(const color_t color,
             real32_t *hue,
             real32_t *sat,
             real32_t *sat);
```

color Color.

hue Hue component.

sat Saturation component.

sat Brightness component.

color_to_html

Convert a color to the HTML or CSS format (#RRGGBB).

```
void
color_to_html(const color_t color,
              char_t *html,
              const uint32_t size);
```

color The color to convert.

html Buffer where to write the result.

size Result buffer size.

color_get_rgb

Returns RGB color values.

```
void
color_get_rgb(const color_t color,
              uint8_t *r,
              uint8_t *g,
              uint8_t *b);
```

color Color.

r Red channel.

g Green channel.

b Blue channel.

Remarks:

In system or indexed colors, it makes effective the RGB value.

color_get_rgbf

Returns RGB color values, normalized from 0 to 1.

```
void
color_get_rgbf(const color_t color,
               real32_t *r,
               real32_t *g,
               real32_t *b);
```

color Color.

r Red channel.

g Green channel.

b Blue channel.

Remarks:

In system or indexed colors, it makes effective the RGB value.

color_get_rgba

Returns the RGBA values of the color.

```
void
color_get_rgba(const color_t color,
               uint8_t *r,
               uint8_t *g,
               uint8_t *b,
```

```
uint8_t *a);
```

- color Color.
- r Red channel.
- g Green channel.
- b Blue channel.
- a Alpha channel (transparency).

Remarks:

In system or indexed colors, it makes effective the RGBA value.

color_get_rgbaf

Returns the RGBA values of the color, normalized from 0 to 1.

```
void
color_get_rgbaf(const color_t color,
                real32_t *r,
                real32_t *g,
                real32_t *b,
                real32_t *a);
```

- color Color.
- r Red channel.
- g Green channel.
- b Blue channel.
- a Alpha channel (transparency).

Remarks:

In system or indexed colors, it makes effective the RGBA value.

color_get_alpha

Get the alpha (transparency) color component.

```
uint8_t
color_get_alpha(const color_t color);
```

- color Color.

Return:

The alpha component. If it is equal 0 it means that the color is indexed (does not contain RGB values).

color_set_alpha

Changes the alpha (transparency) value of a color.

```
color_t
color_set_alpha(const color_t color,
                const uint8_t alpha);
```

color Color.

alpha Alpha component.

Return:

The new color, with the altered alpha component.

palette_create

Create a palette.

```
Palette*
palette_create(const uint32_t size);
```

size The number of colors.

Return:

The palette. The initial content is undetermined. Edit with `palette_colors`.

palette_cga2

Create the 4-color (2-bit) palette of CGA cards.

```
Palette*
palette_cga2(const bool_t mode,
             const bool_t intense);
```

mode `TRUE` for CGA mode 1, `FALSE` mode 0.

intense `TRUE` for bright colors.

Return:

The palette.

Remarks:

“Predefined palette” (page 288)

palette_ega4

Create the default palette for EGA cards (16 colors, 4 bits).

```
Palette*  
palette_ega4(void);
```

Return:

The palette.

Remarks:

“Predefined palette” (page 288)

palette_rgb8

Create the default 8-bit RGB palette. Colors combine 8 tones of red, 8 green and 4 blue.

```
Palette*  
palette_rgb8(void);
```

Return:

The palette.

Remarks:

“Predefined palette” (page 288)

palette_gray1

Create a palette of 2 tones of gray (1 bit). Black (0) and white (1).

```
Palette*  
palette_gray1(void);
```

Return:

The palette.

Remarks:

“Predefined palette” (page 288)

palette_gray2

Create a palette of 4 tones of gray (2 bit). Black (0), White (3).

```
Palette*  
palette_gray2(void);
```

Return:

The palette.

Remarks:

“Predefined palette” (page 288)

palette_gray4

Create a palette of 16 tones of gray (4 bit). Black (0), White (15).

```
Palette*  
palette_gray4(void);
```

Return:

The palette.

Remarks:

“Predefined palette” (page 288)

palette_gray8

Create a palette of 256 shades of gray (8 bit). Black (0), White (255).

```
Palette*  
palette_gray8(void);
```

Return:

The palette.

Remarks:

“Predefined palette” (page 288)

palette_binary

Create a two-color palette.

```
Palette*
palette_binary(const color_t zero,
              const color_t one);
```

zero Color associated with the 0 value.

one Color associated with the 1 value.

Return:

The palette.

palette_destroy

Destroy the palette.

```
void
palette_destroy(Palette **palette);
```

palette The palette. It will be set to `NULL` after the destruction.

palette_size

Returns the number of colors in the palette.

```
uint32_t
palette_size(const Palette *palette);
```

palette The palette.

Return:

The number of colors.

palette_colors

Get the color list.

```
color_t*
palette_colors(Palette *palette);
```

palette The palette.

Return:

Colors. The size of the array is given by `palette_size`.

Remarks:

The buffer is read/write.

palette_colors_const

Get the color list.

```
const color_t*
palette_colors_const(const Palette *palette);
```

palette The palette.

Return:

Colors. The size of the array is given by `palette_size`.

pixbuf_create

Create a new pixel buffer.

```
Pixbuf*
pixbuf_create(const uint32_t width,
             const uint32_t height,
             const pixformat_t format);
```

width Width.

height Height.

format Pixel format.

Return:

The buffer pixel.

Remarks:

Initial content will be undefined.

pixbuf_copy

Create a copy of the pixel buffer.

```
Pixbuf*
pixbuf_copy(const Pixbuf *pixbuf);
```

pixbuf The original buffer.

Return:

The copy.

pixbuf_trim

Crop a buffer pixel.

```

Pixbuf*
pixbuf_trim(const Pixbuf *pixbuf,
            const uint32_t x,
            const uint32_t y,
            const uint32_t width,
            const uint32_t height);

```

pixbuf The original buffer.
 x X coordinate of the upper-left pixel.
 y Y coordinate of the upper-left pixel.
 width Number of pixels wide.
 height Number of pixels high.

Return:

A new buffer pixel with clipping.

Remarks:

The function does not check that the limits are valid. You will get a segmentation error in such cases.

pixbuf_convert

Change the format of a buffer pixel.

```

Pixbuf*
pixbuf_convert(const Pixbuf *pixbuf,
              const Palette *palette,
              const pixformat_t oformat);

```

pixbuf The original buffer.
 palette Color palette required for certain conversions.
 oformat Result buffer format.

Return:

The converted buffer.

Remarks:

See “*Copy and conversion*” (page 291).

pixbuf_destroy

Destroy the buffer.

```
void  
pixbuf_destroy(Pixbuf **pixbuf);
```

pixbuf The buffer. It will be set to `NULL` after the destruction.

pixbuf_format

Get the pixel format.

```
pixformat_t  
pixbuf_format(const Pixbuf *pixbuf);
```

pixbuf The buffer.

Return:

The format.

Remarks:

See “*Pixel formats*” (page 289).

pixbuf_width

Get the width of the buffer.

```
uint32_t  
pixbuf_width(const Pixbuf *pixbuf);
```

pixbuf The buffer.

Return:

Width.

pixbuf_height

Get the height of the buffer.

```
uint32_t  
pixbuf_height(const Pixbuf *pixbuf);
```

`pixbuf` The buffer.

Return:

Height.

pixbuf_size

Get the buffer size (in pixels).

```
uint32_t
pixbuf_size(const Pixbuf *pixbuf);
```

`pixbuf` The buffer.

Return:

Width x height.

pixbuf_dsize

Gets the buffer size (in bytes).

```
uint32_t
pixbuf_dsize(const Pixbuf *pixbuf);
```

`pixbuf` The buffer.

Return:

Number of total bytes in the buffer.

pixbuf_cdata

Gets a read-only pointer to the contents of the buffer.

```
const byte_t*
pixbuf_cdata(const Pixbuf *pixbuf);
```

`pixbuf` The buffer.

Return:

Pointer to the first element.

Remarks:

Correctly manipulating the buffer requires knowing the “*Pixel formats*” (page 289) and sometimes using the operators at the bit level. Use `pixbuf_get` to correctly read a pixel.

pixbuf_data

Gets a read/write pointer to the contents of the buffer.

```
byte_t*
pixbuf_data(Pixbuf *pixbuf);
```

pixbuf The buffer.

Return:

Pointer to the first element.

Remarks:

Correctly manipulating the buffer requires knowing the “*Pixel formats*” (page 289) and sometimes using the operators at the bit level. Use `pixbuf_get` to correctly read a pixel.

pixbuf_format_bpp

Gets bits per pixel based on format.

```
uint32_t
pixbuf_format_bpp(const pixformat_t format);
```

format The format.

Return:

Bits per pixel.

Remarks:

See “*Pixel formats*” (page 289).

pixbuf_get

Get the value of a pixel.

```
uint32_t
pixbuf_get(const Pixbuf *pixbuf,
           const uint32_t x,
           const uint32_t y);
```

pixbuf The buffer.

x Pixel x-coordinate.

y Pixel y coordinate.

Return:

The color value.

Remarks:

See “*Pixel formats*” (page 289) to correctly interpret the value.

pixbuf_set

Sets the value of a pixel.

```
void
pixbuf_set(Pixbuf *pixbuf,
           const uint32_t x,
           const uint32_t y,
           const uint32_t value);
```

pixbuf The buffer.

x Pixel x-coordinate.

y Pixel y coordinate.

value The color value.

Remarks:

See “*Pixel formats*” (page 289) to correctly interpret the value.

image_from_pixels

Create an image from an array of pixels.

```
Image*
image_from_pixels(const uint32_t width,
                 const uint32_t height,
                 const pixformat_t format,
                 const byte_t *data,
                 const color_t *palette,
                 const uint32_t palsize);
```

- width The image width (in pixels).
- height The image height (in pixels).
- format Pixel format.
- data Buffer that contains the color value of each pixel. It will depend on the resolution and format.
- palette Color palette required to render indexed images. If it is `NULL` a “Predefined palette” (page 288) will be used if necessary.
- palsize Number of colors in the palette.

Return:

The image.

Remarks:

See “Pixel access” (page 293).

image_from_pixbuf

Create an image from a buffer pixel.

```
Image*  
image_from_pixbuf(const Pixbuf *pixbuf,  
                 const Palette *palette);
```

- pixbuf The buffer.
- palette The palette.

Return:

The image.

Remarks:

Equal to `image_from_pixels` avoiding indicating parameters separately.

image_from_file

Create an image from a file on disk.

```
Image*  
image_from_file(const char_t *pathname,  
               ferror_t *error);
```

pathname The file path. “*Filename and pathname*” (page 186).

error Error code if the function fails. Can be `NULL`.

Return:

The image.

Remarks:

Only formats *jpg*, *png*, *bmp* and *gif* are accepted.

image_from_data

Create an image from a buffer containing the encoded data.

```
Image*
image_from_data(const byte_t *data,
                const uint32_t size);
```

data The buffer with the image data.

size The buffer size in bytes.

Return:

The image.

Remarks:

The buffer represents data encoded in *jpg*, *png*, *bmp* or *gif*. To create the image directly from pixels use `image_from_pixels`.

image_from_resource

Get an image of a resource package.

```
const Image*
image_from_resource(const ResPack *pack,
                   const ResId id);
```

pack The resource package.

id The resource identifier.

Return:

The image.

Remarks:

The image should not be destroyed with `image_destroy` as it is part of the package itself (it is constant). Make a copy with `image_copy` in case it needs to be kept after destroying the resources. See “Resources” (page 99).

image_copy

Create a copy of the image.

```
Image*
image_copy(const Image *image);
```

`image` The source image.

Return:

The image copy.

Remarks:

Images are immutable objects. Copying really means increasing an internal counter without cloning the object. However, the application must destroy the copy with `image_destroy` just like those created with any other constructor. When all copies are destroyed, it will actually be removed from memory.

image_trim

Create an image by cropping another image.

```
Image*
image_trim(const Image *image,
           const uint32_t x,
           const uint32_t y,
           const uint32_t width,
           const uint32_t height);
```

`image` The source image.

`x` X coordinate of the origin of the sub-image.

`y` Y coordinate of the origin of the sub-image.

`width` Width in pixels of the sub-image.

`height` Height in pixels of the sub-image.

Return:

The new image.

image_rotate

Create a new image by rotating an existing one.

```
Image*
image_rotate(const Image *image,
             const real32_t angle,
             const bool_t nsize,
             const color_t background,
             T2Df *t2d);
```

image The original image.

angle Angle in radians.

nsize **TRUE** the resulting image will be resized to fit the entire original. **FALSE** the resulting image will have the same dimensions as the original, cutting part of the content (clipping).

background Background color. The new image will have “blank” areas due to rotation.

t2d Saves the transformation applied to the image. They can be **NULL** if we don’t need this value.

Return:

The newly created image.

image_scale

Create a copy of the image, with a new size.

```
Image*
image_scale(const Image *image,
            const uint32_t nwidth,
            const uint32_t nheight);
```

image The source image.

nwidth The width of the new image. Pass **UINT32_MAX** so that the aspect ratio with respect to nheight.

nheight The height of the new image. Pass **UINT32_MAX** so that the aspect ratio with respect to nwidth.

Return:

The image.

Remarks:

If both values `nwidth`, `nheight` are `UINT32_MAX` or the new dimensions are identical to the current ones, the internal reference counter will increase, as is the case in `image_copy`.

image_read

Create an image from the data read from a “Streams” (page 201).

```
Image*
image_read(Stream *stm);
```

`stm` Input stream. Data encoded in *jpg*, *png*, *bmp* or *gif* are expected. The function detects the format automatically.

Return:

The image.

image_to_file

Save an image to disk, using the codec associated with it.

```
bool_t
image_to_file(const Image *image,
             const char_t *pathname,
             ferror_t *error);
```

`image` The image.

`pathname` The path of the destination file. “Filename and pathname” (page 186).

`error` Error code if the function fails. Can be `NULL`.

Return:

`TRUE` if it was saved correctly or `FALSE` and an error has occurred.

Remarks:

Use `image_codec` to change the default codec.

image_write

Write an image in an output stream, using the codec associated with it.

```
void
image_write(Stream *stm,
            const Image *image);
```

`stm` Writing stream. Data encoded in *jpg*, *png*, *bmp* or *gif* will be written.
`image` The image.

Remarks:

Use `image_codec` to change the default codec.

image_destroy

Destroy the image.

```
void
image_destroy(Image **image);
```

`image` The image. Will be set to `NULL` after destruction.

image_format

Get the pixel format of the image.

```
pixformat_t
image_format(const Image *image);
```

`image` The image.

Return:

Pixel format.

image_width

Get the width of the image in pixels.

```
uint32_t
image_width(const Image *image);
```

`image` The image.

Return:

Number of pixels wide.

image_height

Get the height of the image in pixels.

```
uint32_t
image_height(const Image *image);
```

image The image.

Return:

Number of pixels in height.

image_pixels

Get a buffer with the pixels that make up the decoded image.

```

Pixbuf*
image_pixels(const Image *image,
             const pixformat_t format);

```

image The image.

format The required pixel format.

Return:

Pixel buffer with image content.

Remarks:

If in `pixformat` we indicate `ekFIMAGE` it will return the buffer with the original format of the image. We can indicate `ekRGB24`, `ekRGBA32` or `ekGRAY8` if we need a specific format. Cannot use indexed formats.

image_codec

Change the default codec associated with the image.

```

bool
image_codec(const Image *image,
            const codec_t codec);

```

```

Image *img = image_from_file("lenna.jpg", NULL);
Stream *stm = stm_socket(ip, port, NULL, NULL);
image_codec(img, ekPNG);
image_write(socket, img);

```

image The image.

codec The new codec.

Return:

`TRUE` if the graphical API supports the selected codec. `FALSE` otherwise.

Remarks:

The change will take effect the next time we save or write the image. By default, the image retains the codec with which it was read. When we create it with `image_from_pixels` `ekJPG` codec is assigned as default. For images from 2d contexts `dctx_image`, the default codec is `ekPNG`. All codecs are supported by all graphical APIs, except `ekGIF` in some versions of Linux. Check the return value if it is imperative that your application export images in GIF.

image_get_codec

Get the codec associated with the image.

```
codec_t
image_get_codec(const Image *image);
```

image The image.

Return:

El codec.

Remarks:

See `image_codec`.

image_num_frames

Get the number of sequences in animated images.

```
uint32_t
image_num_frames(const Image *image);
```

image The image.

Return:

The number of sequences or *frames*.

Remarks:

Only the *gif* format supports animations. For the rest 1 will always be returned.

image_frame_length

Get the time of an animation sequence.

```
real32_t
image_frame_length(const Image *image,
                  const uint32_t findex);
```

image The image.

findex The frame index.

Return:

Sequence time in seconds.

Remarks:

Only *gif* format supports animations.

image_data

Link user data with the image.

```
void  
image_data(Image *image,  
           type *data,  
           FPtr_destroy func_destroy_data,  
           type );
```

image The image.

data The user data.

func_destroy_data Destructor of user data.

User data type.

image_get_data

Gets the user data of the image.

```
type*  
image_get_data(const Image *image,  
              type );
```

image The image.

User data type.

Return:

The user data.

image_native

Gets the image in the native format of each platform.

```
void*
image_native(const Image *image);
```

image The image.

Return:

The native image. `Gdiplus::Bitmap` in Windows, `GdkPixbuf` in Linux and `NSImage` in macOS.

font_create

Create a font.

```
Font*
font_create(const char_t *family,
            const real32_t size,
            const uint32_t style);
```

family Typographic family. Pe: “Arial”, “Times New Roman”, etc.

size Font size. Defaults to pixels. Use `ekFPOINTS` in `style` to change the unit.

style Operation OR | on the fields of the `fstyle_t` structure. Eg: `ekFBOLD` | `ekFITALIC`.

Return:

The newly created font.

font_system

Create a font, with the system’s default family.

```
Font*
font_system(const real32_t size,
            const uint32_t style);
```

size Font size. Defaults to pixels. Use `ekFPOINTS` in `style` to change the unit.

style Operation OR | on the fields of the `fstyle_t` structure. Eg: `ekFBOLD` | `ekFITALIC`.

Return:

The newly created font.

Remarks:

See “*System font*” (page 298).

font_monospace

Create a font, with the system’s default monospace family.

```
Font*
font_monospace(const real32_t size,
               const uint32_t style);
```

size Font size. Defaults to pixels. Use `ekFPOINTS` in `style` to change the unit.

style Operation OR | on the fields of the `fstyle_t` structure. Eg: `ekFBOLD` | `ekFITALIC`.

Return:

The newly created font.

Remarks:

See “*Monospace font*” (page 298).

font_with_style

Create a copy of an existing font, changing the style.

```
Font*
font_with_style(const Font *font,
               const uint32_t style);
```

font Original font.

style Operation OR | on the fields of the `fstyle_t` structure. Eg: `ekFBOLD` | `ekFITALIC`.

Return:

A copy of `font` with another style.

font_copy

Creates an exact copy of a typeface.

```
Font*
font_copy(const Font *font);
```

font Original font.

Return:

The copy of font.

Remarks:

Fonts are immutable objects. Copying really means incrementing an internal counter without actually cloning the object. However, the application must destroy the copy with `font_destroy` just like those created with any other constructor.

font_destroy

Destroy the font.

```
void
font_destroy(Font **font);
```

font The font. It will be set to `NULL` after destruction.

font_equals

Compare two sources. They are considered equal if they have the same family, size and style.

```
bool_t
font_equals(const Font *font1,
            const Font *font2);
```

font1 First font to compare.

font2 Second font to compare.

Return:

`TRUE` if they are equal, `FALSE` if not.

font_regular_size

Gets the default font size for interface controls.

```
real32_t
font_regular_size(void);
```

Return:

The default size in pixels.

Remarks:

See “*System font*” (page 298).

font_small_size

Gets the *small* default font size for interface controls.

```
real32_t  
font_small_size(void);
```

Return:

The size in pixels.

Remarks:

This size is slightly smaller than that obtained by `font_regular_size`.

font_mini_size

Gets the *mini* default font size for interface controls.

```
real32_t  
font_mini_size(void);
```

Return:

The size in pixels.

Remarks:

This size is slightly smaller than that obtained by `font_small_size`.

font_family

Gets the font family.

```
const char_t*  
font_family(const Font *font);
```

`font` The font.

Return:

The font family in UTF8.

font_size

Gets the font size.

```
real32_t
font_size(const Font *font);
```

font The font.

Return:

The size. The units depend on the `style` parameter.

Remarks:

See “*Size and metrics*” (page 300).

font_height

Gets the height of the cell or line of text with this font.

```
real32_t
font_height(const Font *font);
```

font The font.

Return:

Line height.

Remarks:

See “*Size and metrics*” (page 300).

font_ascent

Obtains the measurement of the font above the baseline.

```
real32_t
font_ascent(const Font *font);
```

font The font.

Return:

Above measurement.

Remarks:

See “*Size and metrics*” (page 300).

font_descent

Obtains the measurement of the font below the baseline.

```
real32_t  
font_descent(const Font *font);
```

font The font.

Return:

Below measurement.

Remarks:

See “*Size and metrics*” (page 300).

font_leading

Gets the margin between the character size and the line height.

```
real32_t  
font_leading(const Font *font);
```

font The font.

Return:

Margin.

Remarks:

See “*Size and metrics*” (page 300).

font_is_monospace

Checks if a font is monospaced or not.

```
bool_t  
font_is_monospace(const Font *font);
```

font The font.

Return:

TRUE if the font is monospaced.

Remarks:

See “*Monospace font*” (page 298).

font_style

Gets the style of the font.

```
uint32_t
font_style(const Font *font);
```

font The font.

Return:

The style. Combination of values of the `fstyle_t` structure. Eg: `ekFBOLD` | `ekFITALIC`

font_extents

Gets the size in pixels of a text string, based on the font.

```
void
font_extents(const Font *font,
             const char_t *text,
             const real32_t refwidth,
             real32_t *width,
             real32_t *height);
```

font The font.

text The text string to size.

refwidth Maximum width of the text box or -1 if all the text is on the same line.

width Width of the text box.

height Height of the text box.

font_exists_family

Checks if a font family is installed on the operating system.

```
bool_t
font_exists_family(const char_t *family);
```

family UTF8 string with the family name, null-terminated `'\0'`.

Return:

`TRUE` if the family exists, `FALSE` if not.

font_installed_families

Gets a list of the names of all font families installed on the operating system.

```

ArrPt(String) *
font_installed_families(void);

```

```

ArrPt(String) *families = font_installed_families();
...
arrpt_destroy(&families, str_destroy, String);

```

Return:

Array of `String` with the names of the families, ordered alphabetically. It must be destroyed with `arrpt_destroy`.

Remarks:

See “*Create fonts*” (page 296).

font_installed_monospace

Gets a list of the names of all **monospaced** families installed on the operating system.

```

ArrPt(String) *
font_installed_monospace(void);

```

```

ArrPt(String) *families = font_installed_monospace();
...
arrpt_destroy(&families, str_destroy, String);

```

Return:

Array of `String` with the names of the families, ordered alphabetically. It must be destroyed with `arrpt_destroy`.

Remarks:

See “*Monospace font*” (page 298).

font_native

Gets the source in the native format of each platform.

```

void *
font_native(const Font *font);

```

`font` The font.

Return:

The native source. HFONT on Windows, PangoFontDescription on Linux and NSFont on macOS.

Gui library

43.1. Types and Constants

enum `gui_orient_t`

Orientation.

`ekGUI_HORIZONTAL` Horizontal.
`ekGUI_VERTICAL` Vertical.

enum `gui_state_t`

State values.

`ekGUI_OFF` Off.
`ekGUI_ON` On.
`ekGUI_MIXED` Medium/undetermined.

enum `gui_mouse_t`

Mouse buttons.

`ekGUI_MOUSE_LEFT` Left.
`ekGUI_MOUSE_RIGHT` Right.
`ekGUI_MOUSE_MIDDLE` Center.

enum `gui_cursor_t`

Cursors. See `window_cursor`.

<code>ekGUI_CURSOR_ARROW</code>	Arrow (default).
<code>ekGUI_CURSOR_HAND</code>	Hand.
<code>ekGUI_CURSOR_IBEAM</code>	Vertical bar (text editing).
<code>ekGUI_CURSOR_CROSS</code>	Cross.
<code>ekGUI_CURSOR_SIZEWE</code>	Horizontal resize (left-right).
<code>ekGUI_CURSOR_SIZENS</code>	Vertical resize (top-bottom).
<code>ekGUI_CURSOR_USER</code>	Created from an image.

enum `gui_close_t`

Reason for closing a window.

<code>ekGUI_CLOSE_ESC</code>	The [ESC] key has been pressed (cancel).
<code>ekGUI_CLOSE_INTRO</code>	The [ENTER] key has been pressed (accept).
<code>ekGUI_CLOSE_BUTTON</code>	The close button [X] has been pressed in the title bar.
<code>ekGUI_CLOSE_DEACT</code>	The main window has been clicked (only received by overlay windows).

enum `gui_scale_t`

Scaling modes.

<code>ekGUI_SCALE_AUTO</code>	Automatic scaling, the proportion may change.
<code>ekGUI_SCALE_NONE</code>	No scaling.
<code>ekGUI_SCALE_ASPECT</code>	Automatic scaling, but maintaining the proportion (<i>aspect ratio</i>).
<code>ekGUI_SCALE_ASPECTDW</code>	Same as above, but does not increase the original size, only reduce it if appropriate.

enum `gui_scroll_t`

Types of scroll.

<code>ekGUI_SCROLL_BEGIN</code>	Jump to start.
<code>ekGUI_SCROLL_END</code>	Skip to the end.

<code>ekGUI_SCROLL_STEP_LEFT</code>	Jump one step (or line) to the left or up.
<code>ekGUI_SCROLL_STEP_RIGHT</code>	Jump one step (or line) to the right or down.
<code>ekGUI_SCROLL_PAGE_LEFT</code>	Jump a page to the left or up.
<code>ekGUI_SCROLL_PAGE_RIGHT</code>	Jump a page to the right or down.
<code>ekGUI_SCROLL_THUMB</code>	Jump to the thumb position.

enum `gui_focus_t`

Result when changing the keyboard focus.

<code>ekGUI_FOCUS_CHANGED</code>	The focus has changed to the specified control.
<code>ekGUI_FOCUS_KEEP</code>	The focus has not moved, it remains on the same control.
<code>ekGUI_FOCUS_NO_NEXT</code>	Target control not found, hidden, or disabled.
<code>ekGUI_FOCUS_NO_RESIGN</code>	The current control does not allow changing focus.
<code>ekGUI_FOCUS_NO_ACCEPT</code>	The new control does not accept focus.

enum `gui_tab_t`

Action that has motivated the change of keyboard focus.

<code>ekGUI_TAB_KEY</code>	Pressing the [TAB] key.
<code>ekGUI_TAB_BACKKEY</code>	Pressing [SHIFT]+[TAB].
<code>ekGUI_TAB_NEXT</code>	Call to <code>window_next_tabstop</code> .
<code>ekGUI_TAB_PREV</code>	Call to <code>window_previous_tabstop</code> .
<code>ekGUI_TAB_MOVE</code>	Call to <code>window_focus</code> .
<code>ekGUI_TAB_CLICK</code>	Click on another control.

enum `gui_event_t`

Event type. See “*GUI Events*” (page 308).

<code>ekGUI_EVENT_LABEL</code>	Click on a <code>Label</code> control.
<code>ekGUI_EVENT_BUTTON</code>	Click on a <code>Button</code> control.
<code>ekGUI_EVENT_POPUP</code>	The selection of a <code>PopUp</code> control has been changed.
<code>ekGUI_EVENT_LISTBOX</code>	The selection of a control has been changed <code>ListBox</code> .

<code>ekGUI_EVENT_SLIDER</code>	You are moving an <code>Slidercontrol</code> .
<code>ekGUI_EVENT_UPDOWN</code>	Click on a <code>UpDown</code> control.
<code>ekGUI_EVENT_TXTFILTER</code>	The text of a <code>Edit</code> or <code>Combo</code> control is being edited.
<code>ekGUI_EVENT_TXTCHANGE</code>	You have finished editing the text of a <code>Edit</code> or <code>Combo</code> control.
<code>ekGUI_EVENT_FOCUS_RESIGN</code>	Ask a control if it wants to give up keyboard focus.
<code>ekGUI_EVENT_FOCUS_ACCEPT</code>	Ask a control if it wants to accept keyboard focus.
<code>ekGUI_EVENT_FOCUS</code>	A control has received or lost keyboard focus.
<code>ekGUI_EVENT_MENU</code>	Click on a menu.
<code>ekGUI_EVENT_DRAW</code>	The view content must be redrawn.
<code>ekGUI_EVENT_OVERLAY</code>	There is draw the overlay layer.
<code>ekGUI_EVENT_RESIZE</code>	The size of a view has changed.
<code>ekGUI_EVENT_ENTER</code>	The mouse has entered the view area.
<code>ekGUI_EVENT_EXIT</code>	The mouse has left the view area.
<code>ekGUI_EVENT_MOVED</code>	The mouse is moving on the view surface.
<code>ekGUI_EVENT_DOWN</code>	A mouse button was pressed.
<code>ekGUI_EVENT_UP</code>	A mouse button has been released.
<code>ekGUI_EVENT_CLICK</code>	Click on a view.
<code>ekGUI_EVENT_DRAG</code>	<i>Dragging</i> is being done over.
<code>ekGUI_EVENT_WHEEL</code>	Mouse wheel has moved.
<code>ekGUI_EVENT_KEYDOWN</code>	A key has been pressed.
<code>ekGUI_EVENT_KEYUP</code>	A key has been released.
<code>ekGUI_EVENT_SCROLL</code>	The scroll bars are being manipulated.
<code>ekGUI_EVENT_WND_MOVED</code>	The window is moving across the desktop.
<code>ekGUI_EVENT_WND_SIZING</code>	The window is being resized.
<code>ekGUI_EVENT_WND_SIZE</code>	The window has been resized.
<code>ekGUI_EVENT_WND_CLOSE</code>	The window has been closed.
<code>ekGUI_EVENT_COLOR</code>	An update color of <code>comwin_color</code> .
<code>ekGUI_EVENT_THEME</code>	Desktop theme has changed.

<code>ekGUI_EVENT_OBJCHANGE</code>	An object linked to a layout has been edited. “ <i>Notifications and calculated fields</i> ” (page 385).
<code>ekGUI_EVENT_TBL_NROWS</code>	A table needs to know the number of rows.
<code>ekGUI_EVENT_TBL_BEGIN</code>	A table will begin to draw the visible part of the data.
<code>ekGUI_EVENT_TBL_END</code>	A table has finished drawing.
<code>ekGUI_EVENT_TBL_CELL</code>	A table needs the data of a cell.
<code>ekGUI_EVENT_TBL_SEL</code>	The selected rows in a table have changed.
<code>ekGUI_EVENT_TBL_HEADCLICK</code>	Click on a table header.
<code>ekGUI_EVENT_TBL_ROWCLICK</code>	Click on a table row.

enum window_flag_t

Window creation attributes.

<code>ekWINDOW_FLAG</code>	Default attributes.
<code>ekWINDOW_EDGE</code>	The window draws an outer border.
<code>ekWINDOW_TITLE</code>	The window has a title bar.
<code>ekWINDOW_MAX</code>	The window shows the maximize button.
<code>ekWINDOW_MIN</code>	The window shows the minimize button.
<code>ekWINDOW_CLOSE</code>	The window shows the close button.
<code>ekWINDOW_RESIZE</code>	The window has resizable borders.
<code>ekWINDOW_RETURN</code>	The window will process the pressing of the [RETURN] key as a possible closing event, sending the message OnClose.
<code>ekWINDOW_ESC</code>	The window will process the pressing of the [ESC] key as a possible closing event, sending the message OnClose.
<code>ekWINDOW_MODAL_NOHIDE</code>	Avoids hiding a modal window when the modal cycle has finished. See “ <i>Modal windows</i> ” (page 370).
<code>ekWINDOW_STD</code>	Combination <code>ekWINDOW_TITLE</code> <code>ekWINDOW_MIN</code> <code>ekWINDOW_CLOSE</code> .
<code>ekWINDOW_STDRES</code>	Combination <code>ekWINDOW_STD</code> <code>ekWINDOW_MAX</code> <code>ekWINDOW_RESIZE</code> .

enum gui_notif_t

Notifications sent by the gui library.

<code>ekGUI_NOTIF_LANGUAGE</code>	The interface language has been changed.
<code>ekGUI_NOTIF_WIN_DESTROY</code>	A window has been destroyed.
<code>ekGUI_NOTIF_MENU_DESTROY</code>	A menu has been destroyed.

struct GuiControl

Interface Control (abstract).

```
struct GuiControl;
```

struct Label

Interface control that contains static text, usually limited to a single line. “*Label*” (page 312).

```
struct Label;
```

struct Button

Interface control representing a button. “*Button*” (page 316).

```
struct Button;
```

struct PopUp

Control button with drop-down list. “*PopUp*” (page 319).

```
struct PopUp;
```

struct Edit

Text editing control “*Edit*” (page 319).

```
struct Edit;
```

struct Combo

Control that combines an edit box with a drop-down list. “*Combo*” (page 323).

```
struct Combo;
```

struct ListBox

List control. “*ListBox*” (page 324).

```
struct ListBox;
```

struct UpDown

Control that shows two small increase and decrease buttons. “*UpDown*” (page 324).

```
struct UpDown;
```

struct Slider

Control that shows a bar with a slider. “*Slider*” (page 326).

```
struct Slider;
```

struct Progress

Progress bar. “*Progress*” (page 326).

```
struct Progress;
```

struct View

Custom View that allows to create our own controls, drawing what we want. “*View*” (page 327)

```
struct View;
```

struct TextView

Text view with several paragraphs and different attributes. “*TextView*” (page 332).

```
struct TextView;
```

struct WebView

Web content view. “*WebView*” (page 335).

```
struct WebView;
```

struct ImageView

Image viewer control. “*ImageView*” (page 338).

```
struct ImageView;
```

struct TableView

Table view with multiple rows and columns. “*TableView*” (page 339).

```
struct TableView;
```

struct SplitView

Resizable horizontal or vertical split view. “*SplitView*” (page 347).

```
struct SplitView;
```

struct Layout

Invisible grid where the controls of a `Panel` are organized. “*Layout*” (page 350).

```
struct Layout;
```

struct Cell

Each of the cells that form a `Layout`. “*Cell*” (page 361).

```
struct Cell;
```

struct Panel

Internal area of a window, which allows you to group different controls. “*Panel*” (page 361).

```
struct Panel;
```

struct Window

Interface window. “*Window*” (page 367).

```
struct Window;
```

struct Menu

Menu or submenu. “*Menu*” (page 387).

```
struct Menu;
```

struct MenuItem

Item within a menu. “*MenuItem*” (page 389).

```
struct MenuItem;
```

struct EvButton

Parameters of the *OnClick* event of a button or *OnSelect* of a popup.

```
struct EvButton
{
    uint32_t index;
    gui_state_t state;
    const char_t* text;
};
```

index Button or item index.

state State.

text Text.

struct EvSlider

Parameters of the *OnMoved* event of a slider.

```
struct EvSlider
{
    real32_t pos;
    real32_t incr;
    uint32_t step;
};
```

pos Normalized slider position (0, 1).

incr Increase with respect to the previous position.

step Interval index (only for discrete ranges).

struct EvText

Parameters of the *OnChange* event of the text boxes.

```
struct EvText
{
    const char_t* text;
    uint32_t cpos;
    int32_t len;
};
```

text Text.

cpos Cursor position (*caret*).

len Number of characters inserted or deleted.

struct EvTextFilter

Result of the *OnFilter* event of the text boxes.

```
struct EvTextFilter
{
    bool_t apply;
    char_t* text;
    uint32_t cpos;
};
```

apply **TRUE** if the original control text should be changed.

text New control text, which is a revision (filter) of the original text.

cpos Cursor position (*caret*).

struct EvDraw

OnDraw event parameters.

```
struct EvDraw
{
    DCtx* ctx;
    real32_t x;
    real32_t y;
    real32_t width;
    real32_t height;
};
```

`ctx` 2D drawing context.
`x` X coordinate of the drawing area (viewport).
`y` Y coordinate of the drawing area.
`width` Width of the drawing area.
`height` Height of the drawing area.

struct EvMouse

Mouse event parameters.

```

struct EvMouse
{
    real32_t x;
    real32_t y;
    real32_t lx;
    real32_t ly;
    gui_mouse_t button;
    uint32_t count;
    uint32_t modifiers;
    uint32_t tag;
};
  
```

`x` X coordinate of the pointer in the drawing area.
`y` Y coordinate of the pointer in the drawing area.
`lx` X coordinate of the pointer on the control. Same as `x` if there are no scroll bars.
`ly` Y coordinate of the pointer on the control. Same as `y` if there are no scroll bars.
`button` Active button.
`count` Number of clicks.
`modifiers` Combination of values `mkey_t`.
`tag` Additional value for controls.

struct EvWheel

OnWheel event parameters.

```

struct EvWheel
{
    real32_t x;
    real32_t y;
    real32_t dx;
  
```

```

    real32_t dy;
    real32_t dz;
};

```

- x Pointer x coordinate.
- y Pointer y coordinate.
- dx Increase in x of the wheel or *trackpad*.
- dy Increase in x of the wheel or *trackpad*.
- dz Increase in x of the wheel or *trackpad*.

struct EvKey

Keyboard event parameters.

```

struct EvKey
{
    vkey_t key;
    uint32_t modifiers;
};

```

- key Referenced key.
- modifiers Combination of values `mkey_t`.

struct EvPos

Parameters of change of position events.

```

struct EvPos
{
    real32_t x;
    real32_t y;
};

```

- x X coordinate.
- y Y coordinate.

struct EvSize

Resize event parameters.

```

struct EvSize
{
    real32_t width;
    real32_t height;
};

```

`width` Width (size in x).
`height` Height (size in y).

struct EvWinClose

Window closing Event Parameters.

```
struct EvWinClose
{
    gui_close_t origin;
};
```

`origin` Origin of the close.

struct EvMenu

Menu event parameters.

```
struct EvMenu
{
    uint32_t index;
    gui_state_t state;
    const char_t* text;
};
```

`index` Pressed *item* index.
`state` Pressed *item* status.
`text` Pressed *item* text.

struct EvScroll

Scroll event parameters.

```
struct EvScroll
{
    gui_orient_t orient;
    gui_orient_t scroll;
    real32_t cpos;
};
```

`orient` Scroll bar orientation.
`scroll` Scroll type.
`cpos` Scroll position.

struct EvTbPos

Location of a cell in a table.

```
struct EvTbPos
{
    uint32_t col;
    uint32_t row;
};
```

col Column index.

row Row index.

struct EvTbRow

Location of a row in a table.

```
struct EvTbRow
{
    bool_t sel;
    uint32_t row;
};
```

sel Selected or not.

row Row index.

struct EvTbRect

Group of cells in a table.

```
struct EvTbRect
{
    uint32_t stcol;
    uint32_t edcol;
    uint32_t strow;
    uint32_t edrow;
};
```

stcol Initial column index.

edcol End column index.

strow Initial row index.

edrow End row index.

struct EvTbSel

Selection in a table.

```
struct EvTbSel
{
    ArrSt(uint32_t)* sel;
};
```

sel Row indices.

struct EvTbCell

Data from a cell in a table.

```
struct EvTbCell
{
    const char_t* text;
    align_t align;
};
```

text Cell text.

align Text alignment.

struct FocusInfo

Information about changing the keyboard focus.

```
struct FocusInfo
{
    gui_tab_t action;
    GuiControl* next;
};
```

action Action that has motivated the change of keyboard focus.

next Next control that will receive keyboard focus.

43.2. Functions

gui_start

Start the *Gui* library, reserving space for global internal structures. Internally call `draw2d_start`. It is called automatically by `osmain`.

```
void
gui_start(void);
```

gui_finish

Finish the *Gui* library, freeing up the space of global internal structures. Internally call `draw2d_finish`. It is called automatically by `osmain`.

```
void
gui_finish(void);
```

gui_repack

Register a resource package.

```
void
gui_repack(FPtr_repack func_repack);
```

`func_repack` Resource constructor.

Remarks:

See “*Resources*” (page 99).

gui_language

Set the language of the registered resources with `gui_repack`.

```
void
gui_language(const char_t *lang);
```

`lang` Language.

Remarks:

See “*Resources*” (page 99).

gui_text

Get a text string through its resource identifier.

```
const char_t*
gui_text(const ResId id);
```

`id` Resource Identifier.

Return:

The text string or `NULL` if it is not found.

Remarks:

The resource must belong to a package registered with `gui_respack`.

gui_image

Get an image through its resource identifier.

```
const Image*
gui_image(const ResId id);
```

id Resource Identifier.

Return:

The image or `NULL` if it is not found.

Remarks:

The resource must belong to a package registered with `gui_respack`. Do not destroy the image as it is managed by Gui.

gui_file

Get the contents of a file through its resource identifier.

```
const byte_t*
gui_file(const ResId id,
         uint32_t *size);
```

id Resource Identifier.

size Buffer size in bytes.

Return:

File data or `NULL` if it is not found.

Remarks:

The resource must belong to a package registered with `gui_respack`. The data is managed by Gui, so there is no need to free memory.

gui_dark_mode

Determines if the window environment has a light or dark theme.

```
bool_t
gui_dark_mode(void);
```

Return:

`TRUE` for *Dark mode*, `FALSE` for *light mode*.

gui_alt_color

Create a color with two alternative versions.

```
color_t
gui_alt_color(const color_t light_color,
              const color_t dark_color);
```

`light_color` Color for LIGHT desktop themes.

`dark_color` Color for DARK desktop themes.

Return:

The color.

Remarks:

The system will set the final color based on the “lightness” of the window manager colors (Light/Dark). Nested alternate colors ARE NOT ALLOWED. The `light` and `dark` values must be RGB or system colors.

gui_label_color

Returns the default color of text labels `Label`.

```
color_t
gui_label_color(void);
```

Return:

The color.

gui_view_color

Returns the background color in controls `View`.

```
color_t
gui_view_color(void);
```

Return:

The color.

gui_line_color

Returns the color of lines in tables or window separator elements.

```
color_t  
gui_line_color(void);
```

Return:

The color.

gui_link_color

Returns the color of the text in hyperlinks.

```
color_t  
gui_link_color(void);
```

Return:

The color.

gui_border_color

Returns the border color in button controls, popups, etc..

```
color_t  
gui_border_color(void);
```

Return:

The color.

gui_resolution

Returns screen resolution.

```
S2Df  
gui_resolution(void);
```

Return:

Resolution.

gui_mouse_pos

Returns the position of the mouse cursor.

```
V2Df
gui_mouse_pos(void);
```

Return:

Position.

gui_update

Refreshes all application windows, after a theme change.

```
void
gui_update(void);
```

Remarks:

Normally it is not necessary to call this method. It is called automatically from osapp.

gui_OnThemeChanged

Set a handler to detect the change of the visual theme of the windows environment.

```
void
gui_OnThemeChanged(Listener *listener);
```

listener The event handler.

gui_update_transitions

Update the automatic animations of the interface.

```
void
gui_update_transitions(const real64_t prtime,
                      const real64_t crtime);
```

prtime Time of the previous instant.

crtime Time of the current instant.

Remarks:

Normally it is not necessary to call this method. It is called automatically from osapp.

gui_OnNotification

Sets up a handler to receive notifications from gui.

```
void
gui_OnNotification(Listener *listener);
```

listener The event handler.

Remarks:

See `gui_notif_t`.

gui_OnIdle

Sets a handler to raise an event when the application is in “standby mode”.

```
void
gui_OnIdle(Listener *listener);
```

listener The event handler.

Remarks:

The event will be raised **once** when the application’s message loop is idle, that is, not processing other pending events. See “*GUI Events*” (page 308).

gui_info_window

Displays an information window about the execution of the program. It is aimed at displaying anomaly messages or debugging messages. Do not use for user information.

```
uint32_t
gui_info_window(const bool_t fatal,
               const char_t *msg,
               const char_t *caption,
               const char_t *detail,
               const char_t *file,
               const uint32_t line,
               const ArrPt(String) *buttons,
               const uint32_t defindex);
```

```
uint32_t sel = 0;
ArrPt(String) *buttons = arrpt_create(String);
arrpt_append(buttons, str_c("Ok"), String);
arrpt_append(buttons, str_c("Bye"), String);
arrpt_append(buttons, str_c("Forget"), String);
arrpt_append(buttons, str_c("Ask again"), String);
sel = gui_info_window(TRUE, "Here an info window", "Something happens", "You do
↳ something wrong\nin the file passed as 'stream' parameter.", "your_file
↳ .txt", 43, buttons, 1);
```

```
arrpt_destroy(&buttons, str_destroy, String);
```

fatal **TRUE** if it corresponds to a fatal error.
 msg Summary message.
 caption Title,
 detail Detailed message. Supports '\n'.
 file File related to the message.
 line Line related to the message.
 buttons Buttons.
 defindex Default button.

Return:

Button number pressed.

evbind_object

Gets the object linked to a layout within a callback function.

```
type*
evbind_object(Event *e,
              type);
```

e The event.
 type The object type.

Return:

The object.

Remarks:

See “*Notifications and calculated fields*” (page 385).

evbind_modify

Checks, inside a callback function, if the object’s field has been modified.

```
bool_t
evbind_modify(Event *e,
              type,
              mtype,
              mname);
```

- e The event.
- type The object type.
- mtype The type of the field to check.
- mname The name of the field to check.

Return:

`TRUE` if the field has been modified.

Remarks:

See “*Notifications and calculated fields*” (page 385).

guicontrol

Gets the base object from a derived control.

```
GuiControl*
guicontrol(type *control);
```

control The derived control. `Label`, `Button`, etc.

Return:

Object.

guicontrol_label

Convert a control to a label.

```
Label*
guicontrol_label(GuiControl *control);
```

control Control.

Return:

Object or `NULL` if control cannot be converted.

guicontrol_button

Convert a control to a button.

```
Button*
guicontrol_button(GuiControl *control);
```

control Control.

Return:

Object or `NULL` if `control` cannot be converted.

guicontrol_popup

Convert a control to a popup.

```
PopUp*  
guicontrol_popup(GuiControl *control);
```

`control` Control.

Return:

Object or `NULL` if `control` cannot be converted.

guicontrol_edit

Convert a control to a edit.

```
Edit*  
guicontrol_edit(GuiControl *control);
```

`control` Control.

Return:

Object or `NULL` if `control` cannot be converted.

guicontrol_combo

Convert a control to a combo.

```
Combo*  
guicontrol_combo(GuiControl *control);
```

`control` Control.

Return:

Object or `NULL` if `control` cannot be converted.

guicontrol_listbox

Convert a control to a listbox.

```
ListBox*  
guicontrol_listbox(GuiControl *control);
```

control Control.

Return:

Object or `NULL` if control cannot be converted.

guicontrol_updown

Convert a control to a updown.

```
UpDown*
guicontrol_updown(GtkControl *control);
```

control Control.

Return:

Object or `NULL` if control cannot be converted.

guicontrol_slider

Convert a control to a slider.

```
Slider*
guicontrol_slider(GtkControl *control);
```

control Control.

Return:

Object or `NULL` if control cannot be converted.

guicontrol_progress

Convert a control to a progress.

```
Progress*
guicontrol_progress(GtkControl *control);
```

control Control.

Return:

Object or `NULL` if control cannot be converted.

guicontrol_view

Convert a control to a view.

```
View*  
guicontrol_view(GuiControl *control);
```

control Control.

Return:

Object or **NULL** if control cannot be converted.

guicontrol_textview

Convert a control to a textview.

```
TextView*  
guicontrol_textview(GuiControl *control);
```

control Control.

Return:

Object or **NULL** if control cannot be converted.

guicontrol_webview

Convert a control to a webview.

```
WebView*  
guicontrol_webview(GuiControl *control);
```

control Control.

Return:

Object or **NULL** if control cannot be converted.

guicontrol_imageview

Convert a control to a imageview.

```
ImageView*  
guicontrol_imageview(GuiControl *control);
```

control Control.

Return:

Object or **NULL** if control cannot be converted.

guicontrol_tableview

Convert a control to a tableview.

```
TableView*
guicontrol_tableview(GuiControl *control);
```

control Control.

Return:

Object or **NULL** if control cannot be converted.

guicontrol_splitview

Convert a control to a splitview.

```
SplitView*
guicontrol_splitview(GuiControl *control);
```

control Control.

Return:

Object or **NULL** if control cannot be converted.

guicontrol_panel

Convert a control to a panel.

```
Panel*
guicontrol_panel(GuiControl *control);
```

control Control.

Return:

Object or **NULL** if control cannot be converted.

guicontrol_tag

Sets a tag for the control.

```
void
guicontrol_tag(GuiControl *control,
               const uint32_t tag);
```

control Control.

tag The tag.

guicontrol_get_tag

Gets the tag of the control.

```
uint32_t
guicontrol_get_tag(const GuiControl *control);
```

control Control.

Return:

The tag.

label_create

Create a text control.

```
Label*
label_create(void);
```

Return:

The new label.

label_multiline

Create a multi-line text control.

```
Label*
label_multiline(void);
```

Return:

The new label.

label_OnClick

Set the OnClick event handler.

```
void
label_OnClick(Label *label,
              Listener *listener);
```

```
static void i_OnClick(App *app, Event *e)
{
    const EvText *p = event_params(e, EvText);
    do_something_onclick(app, p->text);
}
...
label_OnClick(label, listener(app, i_OnClick, App));
```

label The label.

listener Event handler.

Remarks:

See “*GUI Events*” (page 308).

label_text

Set the text that the label will display.

```
void
label_text(Label *label,
           const char_t *text);
```

label The label.

text UTF8 C-string terminated in null character '\0'.

label_size_text

Sets the text with which the control will be sized.

```
void
label_size_text(Label *label,
               const char_t *text);
```

label The Label.

text UTF8 C-string terminated in null character '\0'.

Remarks:

By default, a Label control will be sized to the exact size of the text it contains. See “*Dynamic labels*” (page 314).

label_font

Set the text font.

```
void
label_font(Label *label,
           const Font *font);
```

label The label.

font Font.

label_style_over

Set the font modifiers, when the mouse is over the control.

```
void
label_style_over(Label *label,
                 const uint32_t style);
```

label The label.

style Combination of values `fstyle_t`.

label_align

Sets the horizontal alignment of the text with respect to the size of the control.

```
void
label_align(Label *label,
            const align_t align);
```

label The label.

align Alignment.

Remarks:

See “*Dynamic labels*” (page 314).

label_color

Set the text color.

```
void
label_color(Label *label,
            const color_t color);
```

label The label.

color The color.

Remarks:

RGB values may not be fully portable. See “*Colors*” (page 285).

label_color_over

Set the color of the text, when the mouse is over the control.

```
void
label_color_over(Label *label,
                 const color_t color);
```

label The label.

color The color.

Remarks:

RGB values may not be fully portable. See “Colors” (page 285).

label_bgcolor

Set the background color of the text.

```
void
label_bgcolor(Label *label,
              const color_t color);
```

label The label.

color The color.

Remarks:

RGB values may not be fully portable. See “Colors” (page 285).

label_bgcolor_over

Set the background color of the text, when the mouse is over the control.

```
void
label_bgcolor_over(Label *label,
                   const color_t color);
```

label The label.

color El color.

Remarks:

RGB values may not be fully portable. See “Colors” (page 285).

button_push

Create a push button, the typical [Accept], [Cancel], etc.

```
Button*
button_push(void);
```

Return:

The button.

button_check

Create a checkbox.

```
Button*  
button_check(void);
```

Return:

The button.

button_check3

Create a checkbox with three states.

```
Button*  
button_check3(void);
```

Return:

The button.

button_radio

Create a radio button.

```
Button*  
button_radio(void);
```

Return:

The button.

button_flat

Create a flat button, to which an image can be assigned. It is the typical toolbar button.

```
Button*  
button_flat(void);
```

Return:

The button.

button_flatgle

Create a flat button with status. The button will alternate between pressed/released each time you click on it.

```
Button*
button_flatgle(void);
```

Return:

The button.

button_OnClick

Set a function for pressing the button.

```
void
button_OnClick(Button *button,
               Listener *listener);
```

```
static void i_OnClick(App *app, Event *e)
{
    const EvButton *p = event_params(e, EvButton);
    do_something_onclick(app, p->state);
}
...
button_OnClick(button, listener(app, i_OnClick, App));
```

button The button.

listener *Callback* function to be called after clicking.

Remarks:

See “*GUI Events*” (page 308).

button_text

Set the text that the button will display.

```
void
button_text(Button *button,
            const char_t *text);
```

button The button.

text UTF8 C-string terminated in null character '\0'.

Remarks:

In flat buttons, the text will be displayed as *tooltip*.

button_text_alt

Set an alternative text.

```
void
button_text_alt(Button *button,
                const char_t *text);
```

button The button.

text UTF8 C-string terminated in null character '\0'.

Remarks:

Only applicable on flat buttons with status `button_flatgle`. It will be displayed when the button is in `ekGUI_ON` status.

button_tooltip

Set a tooltip for the button. It is a small explanatory text that will appear when the mouse is over the control.

```
void
button_tooltip(Button *button,
               const char_t *text);
```

button The button.

text UTF8 C-string terminated in null character '\0'.

button_font

Set the button font.

```
void
button_font(Button *button,
            const Font *font);
```

button The button.

font Font.

button_image

Set the icon that will show the button.

```
void
button_image(Button *button,
             const Image *image);
```

button The button.

image Image.

Remarks:

Not applicable in checkbox or radiobutton. In flat buttons, the size of the control will be adjusted to the image.

button_image_alt

Set an alternative image for the button.

```
void
button_image_alt(Button *button,
                 const Image *image);
```

button The button.

image Image.

Remarks:

Only applicable on flat buttons with status `button_flatgle`. It will be displayed when the button is in `eKGUI_ON` status.

button_state

Set the button status.

```
void
button_state(Button *button,
              const gui_state_t state);
```

button The button.

state State.

Remarks:

Not applicable on push buttons `button_push`.

button_tag

Sets a numeric tag for the button.

```
void
button_tag(Button *button,
            const uint32_t tag);
```

button The button.

tag The tag.

button_vpadding

Sets the inner vertical margin.

```
void  
button_vpadding(Button *button,  
                const real32_t padding);
```

button The botón.

padding If 0 there will be no margin between the text and the border of the control. If <0 the default margin will be set.

button_get_state

Get button status.

```
gui_state_t  
button_get_state(Button *button);
```

button The button.

Return:

The state.

Remarks:

Not applicable on push buttons `button_push`.

button_get_tag

Gets the button's tag.

```
uint32_t  
button_get_tag(const Button *button);
```

button The button.

Return:

The tag value.

button_get_height

Gets the current height of the control.

```
real32_t
button_get_height(const Button *button);
```

button The button.

Return:

The height of the control, which will change depending on the font size and vpadding.

popup_create

Create a new popup control (*PopUp button*).

```
PopUp*
popup_create(void);
```

Return:

The newly popup.

popup_OnSelect

Set an event handler for the selection of a new item.

```
void
popup_OnSelect(PopUp *popup,
               Listener *listener);

static void i_OnSelect(App *app, Event *e)
{
    const EvButton *p = event_params(e, EvButton);
    do_something_onselect(app, p->index);
}
...
popup_OnSelect(popup, listener(app, i_OnSelect, App));
```

popup The popup.

listener *Callback* function to be called after selecting a new item from the list.

Remarks:

See “*GUI Events*” (page 308).

popup_tooltip

Assign a tooltip to the popup control.

```
void
popup_tooltip(PopUp *popup,
              const char_t *text);
```

popup The popup.

text UTF8 C-string terminated in null character '\0'.

popup_add_elem

Add a new item to the popup list.

```
void
popup_add_elem(PopUp *popup,
               const char_t *text,
               const Image *image);
```

popup The popup.

text The text of the element in UTF-8 or the resource identifier. “Resources” (page 99).

image Icon associated with the resource element or identifier. For space, it will scale to a maximum maximum of 16 pixels.

popup_set_elem

Edit an item from the drop-down list.

```
void
popup_set_elem(PopUp *popup,
               const uint32_t index,
               const char_t *text,
               const Image *image);
```

popup The popup.

index The index of the item to replace.

text The text of the element in UTF-8 or the resource identifier. “Resources” (page 99).

image Icon associated with the resource element or identifier. For space, it will scale to a maximum maximum of 16 pixels.

popup_clear

Remove all items from the dropdown list.

```
void
popup_clear (PopUp *popup);
```

popup The popup.

popup_count

Gets the number of items in the list.

```
uint32_t
popup_count (const PopUp *popup);
```

popup The popup.

Return:

The number of elements.

popup_list_height

Set the size of the drop-down list.

```
void
popup_list_height (PopUp *popup,
                  const uint32_t elems);
```

popup The popup.

elems Number of visible elements. If the control has more, a scroll bar will appear.

popup_selected

Set the selected popup element.

```
void
popup_selected (PopUp *popup,
               const uint32_t index);
```

popup The popup.

index The item to select. If we pass `UINT32_MAX` the selection is removed.

popup_get_selected

Get the selected popup item.

```
uint32_t  
popup_get_selected(const PopUp *popup);
```

popup The popup.

Return:

The selected item.

popup_get_text

Gets the text of a popup element.

```
const char_t*  
popup_get_text(const PopUp *popup,  
               const uint32_t index);
```

popup The popup.

index The index of the element.

Return:

The text of the element.

edit_create

Create a text edit control.

```
Edit*  
edit_create(void);
```

Return:

The edit.

edit_multiline

Create a text editing control that allows multiple lines.

```
Edit*  
edit_multiline(void);
```

Return:

The edit.

edit_OnFilter

Set a function to filter the text while editing.

```
void
edit_OnFilter(Edit *edit,
              Listener *listener);
```

edit The edit.

listener *Callback* function to be called after each key press. In `EvTextFilter` from `event_result` filtered text will be returned.

Remarks:

See “*Filter texts*” (page 320) and “*GUI Events*” (page 308).

edit_OnChange

Set a function to detect when the text has changed.

```
void
edit_OnChange(Edit *edit,
              Listener *listener);
```

edit The edit.

listener *Callback* function to be called when the control loses focus on the keyboard, indicating the end of the edition.

Remarks:

See “*Validate texts*” (page 319) and “*GUI Events*” (page 308).

edit_OnFocus

Sets a handler for keyboard focus.

```
void
edit_OnFocus(Edit *edit,
             Listener *listener);
```

edit The edit.

listener *Callback* function that will be called when keyboard focus is received or lost.

Remarks:

See “*GUI Events*” (page 308).

edit_text

Set the edit control text.

```
void
edit_text(Edit *edit,
          const char_t *text);
```

edit The edit.

text UTF8 C-string terminated in null character '\0'.

edit_font

Set the font of the edit control.

```
void
edit_font(Edit *edit,
          const Font *font);
```

edit The edit.

font Font.

edit_align

Set text alignment.

```
void
edit_align(Edit *edit,
           const align_t align);
```

edit The edit.

align Alignment.

edit_passmode

Activate the password mode, which will hide the typed characters.

```
void
edit_passmode(Edit *edit,
              const bool_t passmode);
```

edit The edit.

passmode Enable or disable password mode.

edit_editable

Enable or disable editing in the control.

```
void
edit_editable(Edit *edit,
              const bool_t is_editable);
```

edit The edit.

is_editable **TRUE** will allow to edit the text (by default).

edit_autoselect

Activate or deactivate auto-selection of text.

```
void
edit_autoselect(Edit *edit,
               const bool_t autoselect);
```

edit The edit.

autoselect **TRUE** the control text will be fully selected when it receives focus. Default **FALSE**.

Remarks:

See “*Text selection*” (page 322).

edit_select

Select text.

```
void
edit_select(Edit *edit,
           const int32_t start,
           const int32_t end);
```

edit The edit.

start Position of the initial character.

end Position of the final character.

Remarks:

See “*Text selection*” (page 322).

edit_tooltip

Assigns a tooltip to the edit control.

```
void
edit_tooltip(Edit *edit,
             const char_t *text);
```

edit The edit.

text UTF8 C-string terminated in null character '\0'.

edit_color

Set the text color.

```
void
edit_color(Edit *edit,
           const color_t color);
```

edit The edit.

color Text color.

Remarks:

RGB values may not be fully portable. See “Colors” (page 285).

edit_color_focus

Sets the color of the text, when the control has the keyboard focus.

```
void
edit_color_focus(Edit *edit,
                 const color_t color);
```

edit The edit.

color Text color.

Remarks:

RGB values may not be fully portable. See “Colors” (page 285).

edit_bgcolor

Set the background color.

```
void
edit_bgcolor(Edit *edit,
             const color_t color);
```

edit The edit.
color Background color.

Remarks:

RGB values may not be fully portable. See “Colors” (page 285).

edit_bgcolor_focus

Sets the background color, when the control has keyboard focus.

```
void
edit_bgcolor_focus(Edit *edit,
                  const color_t color);
```

edit The edit.
color Background color.

Remarks:

RGB values may not be fully portable. See “Colors” (page 285).

edit_phtext

Set an explanatory text for when the control is blank (placeholder).

```
void
edit_phtext(Edit *edit,
            const char_t *text);
```

edit The edit.
text UTF8 C-string terminated in null character '\0'.

edit_phcolor

Set the color of the placeholder text.

```
void
edit_phcolor(Edit *edit,
             const color_t color);
```

edit The edit.
color Text color.

Remarks:

RGB values may not be fully portable. See “Colors” (page 285).

edit_phstyle

Set the font style for the placeholder.

```
void
edit_phstyle(Edit *edit,
             const uint32_t fstyle);
```

edit The edit.

fstyle Combination of values of `fstyle_t`.

edit_vpadding

Sets the inner vertical margin.

```
void
edit_vpadding(Edit *edit,
             const real32_t padding);
```

edit The edit.

padding If 0 there will be no margin between the text and the border of the control. If <0 the default margin will be set.

edit_get_text

Get control text.

```
const char_t*
edit_get_text(const Edit *edit);
```

edit The edit.

Return:

UTF8 C-string terminated in null character '\0'.

edit_get_height

Gets the current height of the control.

```
real32_t
edit_get_height(const Edit *edit);
```

edit The edit.

Return:

The height of the control, which will change depending on the font size and vpadding.

edit_copy

Copies the selected text to the clipboard.

```
void
edit_copy(const Edit *edit);
```

edit The edit.

Remarks:

See “*Clipboard operations*” (page 323).

edit_cut

Cuts the selected text, copying it to the clipboard.

```
void
edit_cut(Edit *edit);
```

edit The edit.

Remarks:

See “*Clipboard operations*” (page 323).

edit_paste

Pastes the text from the clipboard into the caret position.

```
void
edit_paste(Edit *edit);
```

edit The edit.

Remarks:

See “*Clipboard operations*” (page 323).

combo_create

Create a combo control.

```
Combo*
combo_create(void);
```

Return:

The combo.

combo_OnFilter

Set a function to filter the text while editing.

```
void
combo_OnFilter(Combo *combo,
               Listener *listener);
```

combo The combo.

listener *Callback* function to be called after each key press. In `EvTextFilter` from `event_result` filtered text will be returned.

Remarks:

See “*Filter texts*” (page 320) and “*GUI Events*” (page 308).

combo_OnChange

Set a function to be called when the text has changed.

```
void
combo_OnChange(Combo *combo,
               Listener *listener);
```

combo The combo.

listener *Callback* function to be called when the control loses focus on the keyboard, indicating the end of the edition.

Remarks:

This event will also be launched when you select an item from the list, a sign that the text has changed in the edit box. See “*Validate texts*” (page 319) and “*GUI Events*” (page 308).

combo_text

Set the combo edit text.

```
void
combo_text(Combo *combo,
           const char_t *text);
```

combo The combo.

text UTF8 C-string terminated in null character '\0'.

combo_align

Set text alignment.

```
void
combo_align(Combo *combo,
            const align_t align);
```

combo The combo.

align Alignment.

combo_tooltip

Assign a tooltip to the control combo.

```
void
combo_tooltip(Combo *combo,
              const char_t *text);
```

combo The combo.

text UTF8 C-string terminated in null character '\0'.

combo_color

Set the color of the combo text.

```
void
combo_color(Combo *combo,
            const color_t color);
```

combo The combo.

color Text color.

Remarks:

RGB values may not be fully portable. See “*Colors*” (page 285).

combo_color_focus

Sets the color of the text, when the control has the keyboard focus.

```
void
combo_color_focus(Combo *combo,
                  const color_t color);
```

combo The combo.

color Text color.

Remarks:

RGB values may not be fully portable. See “Colors” (page 285).

combo_bgcolor

Set the background color.

```
void
combo_bgcolor(Combo *combo,
              const color_t color);
```

combo The combo.

color Background color.

Remarks:

RGB values may not be fully portable. See “Colors” (page 285).

combo_bgcolor_focus

Sets the background color when the control has keyboard focus.

```
void
combo_bgcolor_focus(Combo *combo,
                   const color_t color);
```

combo The combo.

color Background color.

combo_phtext

Set an explanatory text for when the control is blank.

```
void
combo_phtext(Combo *combo,
             const char_t *text);
```

combo The combo.

text UTF8 C-string terminated in null character '\0'.

combo_phcolor

Set the color of the placeholder text.

```
void
combo_phcolor(Combo *combo,
              const color_t color);
```

combo The combo.

color Text color.

combo_phstyle

Set the font style for the placeholder.

```
void
combo_phstyle(Combo *combo,
              const uint32_t fstyle);
```

combo The combo.

fstyle Combination of values of `fstyle_t`.

combo_get_text

Get control text.

```
const char_t*
combo_get_text(const Combo *combo,
              const uint32_t index);
```

combo The combo.

index The index of the text. If it is `UINT32_MAX` it indicates the text of the edit box itself. If ≥ 0 , indicates a text in the list.

Return:

UTF8 C-string terminated in null character `'\0'`.

combo_count

Gets the number of items in the dropdown list.

```
uint32_t
combo_count(const Combo *combo);
```

combo The combo.

Return:

The number of elements.

combo_add_elem

Add a new item to the drop-down list.

```
void
combo_add_elem(Combo *combo,
               const char_t *text,
               const Image *image);
```

combo The combo.

text The text of the element in UTF-8 or the resource identifier. “*Resources*” (page 99).

image Icon associated with the resource element or identifier. For space, it will scale to a maximum maximum of 16 pixels.

combo_set_elem

Edit an item from the drop-down list.

```
void
combo_set_elem(Combo *combo,
               const uint32_t index,
               const char_t *text,
               const Image *image);
```

combo The combo.

index The index of the item to replace.

text The text of the element in UTF-8 or the resource identifier. “*Resources*” (page 99).

image Icon associated with the resource element or identifier. For space, it will scale to a maximum maximum of 16 pixels.

combo_ins_elem

Insert an item in the drop-down list.

```
void
combo_ins_elem(Combo *combo,
               const uint32_t index,
               const char_t *text,
               const Image *image);
```

- combo The combo.
- index Insertion position.
- text The text of the element in UTF-8 or the resource identifier. “*Resources*” (page 99).
- image Icon associated with the resource element or identifier. For space, it will scale to a maximum maximum of 16 pixels.

combo_del_elem

Remove an item from the drop-down list.

```
void
combo_del_elem(Combo *combo,
               const uint32_t index);
```

- combo The combo.
- index The index of the item to delete.

combo_duplicates

Prevents duplicate texts from the drop-down list.

```
void
combo_duplicates(Combo *combo,
                 const bool_t duplicates);
```

- combo The combo.
- duplicates `TRUE` to allow duplicate texts.

listbox_create

Create a new list control.

```
ListBox*
listbox_create(void);
```

Return:

The newly created listbox.

listbox_OnDown

Sets a handler for a mouse button press.

```

void
listbox_OnDown(ListBox *listbox,
               Listener *listener);

static void i_OnDown(App *app, Event *e)
{
    const EvMouse *p = event_params(e, EvMouse);
    bool_t *r = event_result(e, bool_t);
    p->tag      // Clicked row (UINT32_MAX) if any.
    *r = FALSE; // Avoid item selection.
}
...
listbox_OnDown(list, listener(app, i_OnDown, App));

```

listbox The ListBox.

listener *Callback* function that will be called when a button is pressed.

Remarks:

This event is processed before `listbox_OnSelect`. In the `tag` field of `EvMouse` the number of the element clicked will be received or `UINT32_MAX` if it corresponds to an empty area of the ListBox. If the event returns `FALSE` on `event_result`, the element will be prevented from being selected (`TRUE` by default). See “*GUI Events*” (page 308).

listbox_OnSelect

Set an event handler for the selection of a new item.

```

void
listbox_OnSelect(ListBox *listbox,
                 Listener *listener);

static void i_OnSelect(App *app, Event *e)
{
    const EvButton *p = event_params(e, EvButton);
    do_something_onselect(app, p->index);
}
...
listbox_OnSelect(list, listener(app, i_OnSelect, App));

```

listbox The ListBox.

listener *Callback* function to be called after selecting a new item from the list.

Remarks:

See “*GUI Events*” (page 308).

listbox_size

Set the default size of the list.

```
void
listbox_size(ListBox *listbox,
             const S2Df size);
```

listbox The ListBox.

size The size.

Remarks:

It corresponds to “*Natural sizing*” (page 351) of control Default 128x128.

listbox_checkbox

Show or hide checkboxes to the left of items.

```
void
listbox_checkbox(ListBox *listbox,
                 const bool_t show);
```

listbox ListBox.

show `TRUE` for show them.

listbox_multisel

Enable multiple selection.

```
void
listbox_multisel(ListBox *listbox,
                 const bool_t multisel);
```

listbox ListBox.

multisel `TRUE` to allow multiple selected items at the same time.

listbox_add_elem

Adds a new element.

```
void
listbox_add_elem(ListBox *listbox,
                 const char_t *text,
                 const Image *image);
```

- listbox ListBox.
- text The text of the element in UTF-8 or the identifier of the resource. “*Resources*” (page 99).
- image Icon associated with the element or resource identifier.

listbox_set_elem

Edit a list item.

```
void
listbox_set_elem(ListBox *listbox,
                 const uint32_t index,
                 const char_t *text,
                 const Image *image);
```

- listbox ListBox.
- index The index of the element to replace.
- text The text of the element in UTF-8 or the identifier of the resource. “*Resources*” (page 99).
- image Icon associated with the element or resource identifier.

listbox_clear

Remove all items from the list.

```
void
listbox_clear(ListBox *listbox);
```

- listbox ListBox.

listbox_color

Sets the text color of an element.

```
void
listbox_color(ListBox *listbox,
              const uint32_t index,
              const color_t color);
```

- listbox ListBox.
- index The element index.
- color The. By default `kCOLOR_DEFAULT`.

listbox_select

Select an item from the program code.

```
void
listbox_select(ListBox *listbox,
               const uint32_t index,
               const bool_t select);
```

listbox ListBox.

index The index of the item to select.

select Select or deselect.

Remarks:

If multiple selection is not enabled, selecting one item implies de-selecting all the others.

listbox_check

Check or uncheck the checkbox of the element from the program code.

```
void
listbox_check(ListBox *listbox,
              const uint32_t index,
              const bool_t check);
```

listbox ListBox.

index The element index.

check Check or uncheck.

Remarks:

Checking an item is independent of selecting it. Items can be marked even if checkboxes are not visible. See `listbox_checkbox`.

listbox_count

Returns the number of elements in the list.

```
uint32_t
listbox_count(const ListBox *listbox);
```

listbox ListBox.

Return:

The number of elements.

listbox_text

Returns the text of an element.

```

const char_t*
listbox_text(const ListBox *listbox,
             const uint32_t index);

```

listbox ListBox.

index The element index.

Return:

The UTF-8 text terminated in null character '\0'.

listbox_selected

Returns whether or not an element is selected.

```

bool_t
listbox_selected(const ListBox *listbox,
                 const uint32_t index);

```

listbox ListBox.

index The element index.

Return:

The selection state.

listbox_checked

Returns whether an element is checked or not.

```

bool_t
listbox_checked(const ListBox *listbox,
                const uint32_t index);

```

listbox ListBox.

index The element index.

Return:

The checkbox state.

Remarks:

Checking an item is independent of selecting it. Items can be marked even if checkboxes are not visible. See `listbox_checkbox`.

updown_create

Create an updown control.

```
UpDown*
updown_create(void);
```

Return:

The updown.

updown_OnClick

Set an event handler for pressing the button.

```
void
updown_OnClick(UpDown *updown,
               Listener *listener);
```

```
static void i_OnClick(App *app, Event *e)
{
    const EvButton *p = event_params(e, EvButton);
    if (p->index == 0)
        do_something_onup(app);
    else
        do_something_ondown(app);
}
...
updown_OnClick(updown, listener(app, i_OnClick, App));
```

updown The updown.

listener *Callback* function to be called after clicking.

Remarks:

See “*GUI Events*” (page 308).

updown_tooltip

Set a tooltip for the button. It is a small explanatory text that will appear when the mouse is over the control.

```
void
updown_tooltip(UpDown *updown,
               const char_t *text);
```

updown The updown.

text UTF8 C-string terminated in null character '\0'.

slider_create

Create a new slider control.

```
Slider*
slider_create(void);
```

Return:

Slider.

slider_vertical

Create a new vertical slider.

```
Slider*
slider_vertical(void);
```

Return:

Slider.

slider_OnMoved

Set an event handler for slider movement.

```
void
slider_OnMoved(Slider *slider,
               Listener *listener);
```

```
static void i_OnMoved(App *app, Event *e)
{
    const EvSlider *p = event_params(e, EvSlider);
    do_something_onmoved(app, p->pos);
}
...
slider_OnMoved(slider, listener(app, i_OnMoved, App));
```

slider Slider.

listener *Callback* function that will be called continuously while the user moves a slider.

Remarks:

`EvSlider` contains the event parameters, see “*GUI Events*” (page 308).

slider_tooltip

Set a tooltip for the slider. It is a small explanatory text that will appear when the mouse is over the control.

```
void
slider_tooltip(Slider *slider,
               const char_t *text);
```

slider Slider.

text UTF8 C-string terminated in null character '\0'.

slider_steps

Changes the slider from continuous range to discrete intervals.

```
void
slider_steps(Slider *slider,
             const uint32_t steps);
```

slider Slider.

steps Number of intervals. Use `UINT32_MAX` to return to continuous range.

slider_value

Set the slider position.

```
void
slider_value(Slider *slider,
             const real32_t value);
```

slider Slider.

value The position between 0.0 and 1.0.

slider_get_value

Get the slider position.

```
real32_t
slider_get_value(const Slider *slider);
```

slider Slider.

Return:

The normalized position between 0.0 and 1.0.

progress_create

Create a progress bar.

```
Progress*
progress_create(void);
```

Return:

The progress.

progress_undefined

Set the progress bar as undefined.

```
void
progress_undefined(Progress *progress,
                  const bool_t running);
```

progress The progress.

running `TRUE` to activate the animation.

progress_value

Set the progress position.

```
void
progress_value(Progress *progress,
              const real32_t value);
```

progress The progress.

value The position between 0.0 and 1.0.

view_create

Create a new custom view.

```
View*
view_create(void);
```

Return:

The view.

view_scroll

Create a new custom view with scrollbars.

```
View*
view_scroll(void);
```

Return:

The view.

view_custom

Create a new view with all the options.

```
View*
view_custom(const bool_t scroll,
            const bool_t border);
```

scroll Use of scroll bars.

border Draw a border.

Return:

The view.

Remarks:

Many window managers highlight the border when the view has keyboard focus.

view_data

Associate user data with the view.

```
void
view_data(View *view,
          type **data,
          FPtr_destroy func_destroy_data,
          type);
```

view The view.

data User data.

func_destroy_data Destructor of user data. It will be called upon destroying the view.

type Type of user data.

view_get_data

Obtiene los datos de usuario asociados con la vista.

```

type*
view_get_data(const View *view,
              type);

```

view The view.

type Type of user data.

Return:

Los datos de usuario.

view_size

Set the default view size.

```

void
view_size(View *view,
          const S2Df size);

```

view The view.

size The size.

Remarks:

It corresponds to “*Natural sizing*” (page 351) of control Default 128x128.

view_OnDraw

Set an event handler to draw in the view.

```

void
view_OnDraw(View *view,
            Listener *listener);

```

view The view.

listener *Callback* function to be called every time the drawing needs to be refreshed.

Remarks:

See “*Draw in views*” (page 328) and “*GUI Events*” (page 308).

view_OnOverlay

Sets an event handler to draw the overlay.

```
void
view_OnOverlay(View *view,
               Listener *listener);
```

view The view.

listener *Callback* function to be called every time the overlay needs to be refreshed.

Remarks:

Ver “*Drawing overlays*” (page 330) and “*GUI Events*” (page 308).

view_OnSize

Set an event handler for resizing.

```
void
view_OnSize(View *view,
            Listener *listener);
```

view The view.

listener *Callback* function to be called every time the view changes size.

Remarks:

See “*GUI Events*” (page 308).

view_OnEnter

Set an event handler for mouse enter.

```
void
view_OnEnter(View *view,
             Listener *listener);
```

view The view.

listener *Callback* function to be called when the mouse cursor enters the view area.

Remarks:

See “*Using the mouse*” (page 331) and “*GUI Events*” (page 308).

view_OnExit

Set an event handle for mouse exit.

```
void
view_OnExit(View *view,
            Listener *listener);
```

view The view.

listener *Callback* function to be called when the mouse cursor exits the view area.

Remarks:

See “*Using the mouse*” (page 331) and “*GUI Events*” (page 308).

view_OnMove

Set an event handler for mouse movement.

```
void
view_OnMove(View *view,
            Listener *listener);
```

view The view.

listener *Callback* function to be called as the mouse cursor moves over the view.

Remarks:

See “*Using the mouse*” (page 331) and “*GUI Events*” (page 308).

view_OnDown

Sets an event handler for a mouse button down.

```
void
view_OnDown(View *view,
            Listener *listener);
```

view The view.

listener *Callback* function that will be called every time the button is down.

Remarks:

See “*Using the mouse*” (page 331) and “*GUI Events*” (page 308).

view_OnUp

Sets an event handler for a mouse button up.

```
void
view_OnUp(View *view,
          Listener *listener);
```

view The view.

listener *Callback* function that will be called every time the button is up.

Remarks:

See “*Using the mouse*” (page 331) and “*GUI Events*” (page 308).

view_OnClick

Set an event handler for mouse click.

```
void
view_OnClick(View *view,
             Listener *listener);
```

view The view.

listener *Callback* function that will be called every time the view is clicked.

Remarks:

See “*Using the mouse*” (page 331) and “*GUI Events*” (page 308).

view_OnDrag

Set an event handler for mouse drag.

```
void
view_OnDrag(View *view,
            Listener *listener);
```

view The view.

listener *Callback* function to be called while dragging the mouse cursor over the view.

Remarks:

“Drag” is to move the mouse with one of the buttons pressed. See “*Using the mouse*” (page 331) and “*GUI Events*” (page 308).

view_OnWheel

Set an event handler for mouse wheel.

```
void
view_OnWheel (View *view,
              Listener *listener);
```

view The view.

listener *Callback* function that will be called when the mouse wheel moves over the view.

Remarks:

See “*Using the mouse*” (page 331) and “*GUI Events*” (page 308).

view_OnKeyDown

Set an event handler for a keystroke.

```
void
view_OnKeyDown (View *view,
                Listener *listener);
```

view The view.

listener *Callback* function to be called when a key is pressed and the view has the keyboard focus.

Remarks:

See “*Using the keyboard*” (page 332) and “*GUI Events*” (page 308).

view_OnKeyUp

Set an event handler for releasing a key.

```
void
view_OnKeyUp (View *view,
              Listener *listener);
```

view The view.

listener *Callback* function to be called when a key is released and the view has the keyboard focus.

Remarks:

See “*Using the keyboard*” (page 332) and “*GUI Events*” (page 308).

view_OnFocus

Sets an event handler for keyboard focus.

```
void
view_OnFocus (View *view,
              Listener *listener);
```

view The view.

listener *Callback* function to be called when keyboard focus is received or lost.

Remarks:

See “*Using the keyboard*” (page 332) and “*GUI Events*” (page 308).

view_OnResignFocus

Set a handler to avoid losing keyboard focus.

```
void
view_OnResignFocus (View *view,
                   Listener *listener);
```

view The view.

listener *Callback* function that is called when the view is about to lose focus. If we return **FALSE**, the focus will not go to another control, it will remain in the view.

Remarks:

See “*Using the keyboard*” (page 332) and “*GUI Events*” (page 308).

view_OnAcceptFocus

Set a handler to prevent getting keyboard focus.

```
void
view_OnAcceptFocus (View *view,
                   Listener *listener);
```

view The view.

listener *Callback* function that is called when the view is about to get focus. If we return **FALSE**, the focus will remain on the current control and will not move to the view.

Remarks:

See “*Using the keyboard*” (page 332) and “*GUI Events*” (page 308).

view_OnScroll

Set an event handler for the scroll bars.

```
void
view_OnScroll(View *view,
              Listener *listener);
```

view The view.

listener *Callback* function to be called when the user manipulates the scroll bars.

Remarks:

It is not common to have to respond to these events, since the view generates `OnDraw` events automatically when the scroll bars are manipulated. See “*Scrolling views*” (page 328) and “*GUI Events*” (page 308).

view_allow_tab

Allows to capture the press of the [TAB] key.

```
void
view_allow_tab(View *view,
               const bool_t allow);
```

view The view.

allow Whether or not to allow the capture of [TAB].

Remarks:

If `TRUE` the pressing of [TAB] with the keyboard focus in the view will be captured as a `KeyDown` event and not as navigation between the controls. The call to this function will have no effect if there is no associated `OnKeyDown` handler. In general, you should not use this function.

view_keybuf

Sets a keyboard buffer for synchronous or asynchronous query of key state.

```
void
view_keybuf(View *view,
            Keybuf *buffer);
```

view The view.

buffer Keyboard buffer that will be maintained by the view, capturing the `OnKeyDown` and `OnKeyUp` events.

Remarks:

It just keeps a reference to the buffer, which will need to be destroyed by the object that created it. See “*Keyboard buffer*” (page 238). The application will still be able to receive keyboard events through `view_OnKeyDown` and `view_OnKeyUp`.

view_get_size

Gets the current size of the view.

```
void
view_get_size(const View *view,
              S2Df *size);
```

view The view.

size The size.

view_content_size

Set the size of the drawing area when scroll bars exist.

```
void
view_content_size(View *view,
                  const S2Df size);
```

view The view.

size The internal size of the drawing area.

Remarks:

When creating a scroll view, this method indicates the entire drawing area. The control will use it to size and position the scroll bars.

view_scroll_x

Move the horizontal scroll bar to the indicated position.

```
void
view_scroll_x(View *view,
              const real32_t pos);
```

view The view.

pos New horizontal bar position.

view_scroll_y

Move the vertical scroll bar to the indicated position.

```
void
view_scroll_y(View *view,
              const real32_t pos);
```

view The view.

pos New vertical bar position.

view_scroll_size

Gets the measurements of the scroll bars.

```
void
view_scroll_size(const View *view,
                 real32_t *width,
                 real32_t *height);
```

view The view.

width The width of the vertical bar.

height The height of the horizontal bar.

Remarks:

Useful to consider what the scroll bars occupy when drawing. If the bars overlap, 0 will be returned.

view_scroll_visible

Show or hide the scroll bars.

```
void
view_scroll_visible(View *view,
                   const bool_t horizontal,
                   const bool_t vertical);
```

view The view.

horizontal Horizontal bar.

vertical Vertical bar.

view_viewport

Gets the dimensions of the visible area of the view.

```
void
view_viewport(const View *view,
              V2Df *pos,
              S2Df *size);
```

- view The view.
- pos The position of the viewport. It can be `NULL`.
- size The size of the viewport. It can be `NULL`.

Remarks:

If the view does not have scroll bars, `pos` will be `(0, 0)`.

view_point_scale

Gets the scaling of the point.

```
void
view_point_scale(const View *view,
                 real32_t *scale);
```

- view The view.
- scale The scaling.

Remarks:

The view size and drawing coordinates are expressed in points, which typically correspond to pixels (1pt = 1px). In “*Retina displays*” (page 272) it can happen that (1pt = 2px). Although “*2D Contexts*” (page 265) handles this automatically, we may need to know the number of pixels to create another type of *framebuffers* (OpenGL, DirectX, etc).
 Pixels = `view_get_size` * `view_point_scale`.

view_update

Send an order to the operating system that the view should be refreshed.

```
void
view_update(View *view);
```

- view The view.

view_native

Gets a pointer to the native control.

```
void*
view_native(View *view);
```

view The view.

Return:

HWND in Windows, GtkWidget in Linux and NSView in macOS.

Remarks:

Do not use this function if you do not know very well what you are doing.

textview_create

Create a text view.

```
TextView*
textview_create(void);
```

Return:

The text view.

textview_OnFilter

Set a handler to filter text while editing.

```
void
textview_OnFilter(TextView *view,
                  Listener *listener);
```

view The view.

listener *Callback* function that will be called after each key press. In `EvTextFilter` of `event_result` the filtered text will be returned.

Remarks:

It works the same way as in Edit controls. See “*Filter texts*” (page 320) and “*GUI Events*” (page 308).

textview_OnFocus

Sets a handler for keyboard focus.

```
void
textview_OnFocus(TextView *view,
                 Listener *listener);
```

view The view.
 listener *callback* function that will be called when keyboard focus is received or lost.

Remarks:

See “*GUI Events*” (page 308).

textview_size

Sets the default size of the view.

```
void
textview_size(TextView *view,
              const S2Df size);
```

view The view.
 size The size.

Remarks:

It corresponds to the “*Natural sizing*” (page 351) of the control. Default 245x144.

textview_clear

Clears all content from view.

```
void
textview_clear(TextView *view);
```

view The view.

textview_printf

Writes text to the view, using the format of the printf.

```
uint32_t
textview_printf(TextView *view,
                const char_t *format,
                ...);
```

```
textview_printf(view, Code: %-10s Price %5.2f\n", code, price);
```

view The view.
 format String in type-printf format with a variable number of parameters.
 ... Printf arguments or variables.

Return:

The number of bytes written.

textview_writeln

Write a C UTF8 string to the view.

```
void
textview_writeln(TextView *view,
                 const char_t *str);
```

view The view.

str String C UTF8 terminated in null character '\0'.

textview_rtf

Insert text in Microsoft **RTF** format.

```
void
textview_rtf(TextView *view,
             Stream *rtf_in);
```

view The view.

rtf_in Reading stream with RTF content.

textview_units

Sets the text units.

```
void
textview_units(TextView *view,
               const uint32_t units);
```

view The view.

units Units `ekFPixels` or `ekFPoints`.

Remarks:

`ekFPoints` is the default value and the one normally used by word processors. See “*Size in points*” (page 300).

textview_family

Sets the font family of the text (“*Arial*”, “*Times New Roman*”, “*Helvetica*”, etc).

```
void
textview_family(TextView *view,
                const char_t *family);
```

view The view.

family The font family.

Remarks:

Not all families will be present on all platforms. Use `font_exists_family` or `font_installed_family` to check.

textview_fsize

Set the text size.

```
void
textview_fsize(TextView *view,
                const real32_t size);
```

view The view.

size The size.

Remarks:

The value is conditional on the units established in `textview_units`.

textview_fstyle

Sets the text style.

```
void
textview_fstyle(TextView *view,
                 const uint32_t fstyle);
```

view The view.

fstyle Combination of `ekFBOLD`, `ekFITALIC`, `ekFSTRIKEOUT`, `ekFUNDERLINE`, `ekFSUBSCRIPT`, `ekFSUPSCRIPT`. To override any previous style use `ekFNORMAL`.

textview_color

Sets the text color.

```
void
textview_color(TextView *view,
               const color_t color);
```

view The view.

color The color. Use `kCOLOR_DEFAULT` to restore the default color.

textview_bgcolor

Sets the background color of the text.

```
void
textview_bgcolor(TextView *view,
                 const color_t color);
```

view The view.

color The color. Use `kCOLOR_DEFAULT` to restore the default color.

textview_pgcolor

Sets the background color of the control.

```
void
textview_pgcolor(TextView *view,
                 const color_t color);
```

view The view.

color The color. Use `kCOLOR_DEFAULT` to restore the default color.

textview_halign

Sets the alignment of text in a paragraph.

```
void
textview_halign(TextView *view,
                const align_t align);
```

view The view.

align The alignment. By default `ekLEFT`.

textview_lspacing

Sets the line spacing of the paragraph.

```
void
textview_lspacing(TextView *view,
                  const real32_t scale);
```

view The view.

scale Scale factor in font height. 1 is the default value, 2 twice this height, 3 triple, etc. Intermediate values are also valid (eg 1.25).

textview_bfspace

Sets a vertical space before the paragraph.

```
void
textview_bfspace(TextView *view,
                  const real32_t space);
```

view The view.

space The space in the preset units.

textview_afspace

Sets a vertical space after the paragraph.

```
void
textview_afspace(TextView *view,
                  const real32_t space);
```

view The view.

space The space in the preset units.

textview_apply_all

Applies the character and paragraph attributes to all text in the control. If there is no text, they will be taken as the **default attributes** of the text added using the keyboard.

```
void
textview_apply_all(TextView *view);
```

```
textview_family(view, "Arial");
textview_fsize(view, 16);
textview_color(view, kCOLOR_RED);
// Arial:16:Red to all text or default
textview_apply_all(view);
```

view The view.

Remarks:

See “*Apply attributes*” (page 335).

textview_apply_sel

Applies character and paragraph attributes to selected text.

```
void
textview_apply_sel(TextView *view);
```

view The view.

Remarks:

See “*Apply attributes*” (page 335).

textview_scroll_visible

Show or hide scroll bars.

```
void
textview_scroll_visible(TextView *view,
                        const bool_t horizontal,
                        const bool_t vertical);
```

view The view.

horizontal Horizontal bar.

vertical Vertical bar.

textview_editable

Sets whether or not the control text is editable.

```
void
textview_editable(TextView *view,
                  const bool_t is_editable);
```

view The view.

is_editable **TRUE** will allow you to edit the text. By default **FALSE**.

textview_select

Select text.

```
void
textview_select(TextView *view,
                const int32_t start,
                const int32_t end);
```

- view The view.
- start Position of the initial character.
- end Position of the final character.

Remarks:

It works the same way as in Edit controls. See “*Text selection*” (page 322).

textview_show_select

Sets whether to show or hide the text selection when keyboard focus is lost.

```
void
textview_show_select(TextView *view,
                    const bool_t show);
```

- view The view.
- show Show or hide. By default `FALSE`.

Remarks:

When lose keyboard focus, the control will retain the text selection. This feature only affects the visibility of the selection.

textview_scroll_caret

In texts that exceed the visible part, it scrolls to the position of the caret.

```
void
textview_scroll_caret(TextView *view);
```

- view The view.

textview_get_text

Gets the text of the control.

```
const char_t*
textview_get_text(const TextView *view);
```

- view The view.

Return:

Null-terminated UTF8 C string '\0'.

textview_copy

Copies the selected text to the clipboard.

```
void
textview_copy(const TextView *view);
```

view The view.

Remarks:

It works the same way as in Edit controls. See “*Clipboard operations*” (page 323).

textview_cut

Cuts the selected text, copying it to the clipboard.

```
void
textview_cut(TextView *view);
```

view The view.

Remarks:

It works the same way as in Edit controls. See “*Clipboard operations*” (page 323).

textview_paste

Pastes the text from the clipboard into the caret position.

```
void
textview_paste(TextView *view);
```

view The view.

Remarks:

It works the same way as in Edit controls. See “*Clipboard operations*” (page 323).

textview_wrap

Turn automatic text wrapping on or off.

```
void
textview_wrap(TextView *view,
              const bool_t wrap);
```

- view The view.
- wrap Activate or deactivate. By default `TRUE`.

Remarks:

See “*Text wrapping*” (page 335).

webview_create

Create a Web View.

```
WebView*
webview_create(void);
```

Return:

The Web View.

webview_OnFocus

Sets a handler for keyboard focus.

```
void
webview_OnFocus(WebView *view,
                Listener *listener);
```

- view The view.
- listener *callback* function that will be called when keyboard focus is received or lost.

Remarks:

See “*GUI Events*” (page 308).

webview_size

Sets the default size of the view.

```
void
webview_size(WebView *view,
             const S2Df size);
```

- view The view.
- size The size.

Remarks:

Corresponds to the “*Natural sizing*” (page 351) of the control. By default 245x144.

webview_navigate

Loads a URL in the web view.

```
void
webview_navigate(WebView *view,
                 const char_t *url);
```

view The view.

url URL to load, null-terminated UTF8 C string '\0'.

webview_back

Go back to the previous page in the browser stack.

```
void
webview_back(WebView *view);
```

view The view.

webview_forward

Moves to the next page in the browser stack.

```
void
webview_forward(WebView *view);
```

view The view.

imageview_create

Create an image view control.

```
ImageView*
imageview_create(void);
```

Return:

The image view.

imageview_size

Set the default control size.

```
void
imageview_size(ImageView *view,
               const S2Df size);
```

view The view.

size The size.

imageView_scale

Set the scaling to apply to the image.

```
void
imageView_scale(ImageView *view,
                const gui_scale_t scale);
```

view The view.

scale Scaling.

imageView_image

Set the image to be displayed in the control.

```
void
imageView_image(ImageView *view,
                const Image *image);
```

view The view.

image The image to show.

imageView_OnClick

Set a handle for the event click on the image.

```
void
imageView_OnClick(ImageView *view,
                  Listener *listener);
```

view The view.

listener *Callback* function to be called after clicking.

imageView_OnOverDraw

Allows you to draw an *overlay* on the image when the mouse is over it.

```
void
imageView_OnOverDraw(ImageView *view,
                     Listener *listener);
```

- view The view.
- listener *Callback* function that will be called when the mouse is over the image. Here we will include the additional drawing code.

tableview_create

Creates a new table view.

```
TableView*
tableview_create(void);
```

Return:

The table.

tableview_OnData

Sets up a handler to read data from the application.

```
void
tableview_OnData(TableView *view,
                 Listener *listener);
```

- view The table.
- listener A *callback* function that will be called each time the table needs to update its content.

Remarks:

See “*Data connection*” (page 339).

tableview_OnSelect

Notifies that the selection has changed.

```
void
tableview_OnSelect(TableView *view,
                  Listener *listener);
```

- view The table.
- listener A *callback* function that will be called whenever the selection in the table changes.

Remarks:

See “*Multiple selection*” (page 344).

tableView_OnRowClick

Notify each time a row is clicked.

```
void
tableView_OnRowClick(tableView *view,
                    listener *listener);
```

view The table.

listener *Callback* function that will be called every time a row is clicked.

Remarks:

See “*Notifications in tables*” (page 345).

tableView_OnHeaderClick

Notifies each time a header is clicked.

```
void
tableView_OnHeaderClick(tableView *view,
                       listener *listener);
```

view The table.

listener *Callback* function that will be called every time a table header is clicked.

Remarks:

See “*Notifications in tables*” (page 345).

tableView_font

Sets the general font for the entire table.

```
void
tableView_font(tableView *view,
              const Font *font);
```

view The table.

font Font.

Remarks:

See “*Table appearance*” (page 346).

tableview_size

Sets the default size of the table control.

```
void
tableview_size(Tableview *view,
               const S2Df size);
```

view The table.

size The size.

Remarks:

Corresponds to the “*Natural sizing*” (page 351) of the control. By default 256x128.

tableview_new_column_text

Adds a new column to the table.

```
uint32_t
tableview_new_column_text(Tableview *view);
```

view The table.

Return:

The column identifier (index).

Remarks:

See “*Configure columns*” (page 345).

tableview_column_width

Sets the width of a column.

```
void
tableview_column_width(Tableview *view,
                      const uint32_t column_id,
                      const real32_t width);
```

view The table.

column_id The column id.

width The column width.

Remarks:

See “*Configure columns*” (page 345).

view The table.

last_column_id The identifier of the last column set.

Remarks:

See “*Configure columns*” (page 345).

tableview_header_title

Sets the text of a column header.

```
void
tableview_header_title(Tableview *view,
                       const uint32_t column_id,
                       const char_t *text);
```

view The table.

column_id The column id.

text The text in UTF-8 or the identifier of the resource. “*Resources*” (page 99).

Remarks:

See “*Configure columns*” (page 345).

tableview_header_align

Sets the alignment of the header text.

```
void
tableview_header_align(Tableview *view,
                       const uint32_t column_id,
                       const align_t align);
```

view The table.

column_id The column id.

align The alignment.

Remarks:

See “*Configure columns*” (page 345).

tableview_header_visible

Sets whether the table header is visible or not.

```
void
tableview_header_visible(Tableview *view,
                        const bool_t visible);
```

view The table.

visible `TRUE` to display the header.

Remarks:

See “*Table appearance*” (page 346).

tableview_header_clickable

Sets whether the table header can be clicked as a button.

```
void
tableview_header_clickable(Tableview *view,
                          const bool_t clickable);
```

view The table.

clickable `TRUE` to allow clicks.

Remarks:

See “*Notifications in tables*” (page 345).

tableview_header_resizable

Sets whether the header allows column resizing.

```
void
tableview_header_resizable(Tableview *view,
                          const bool_t resizable);
```

view The table.

resizable `TRUE` if resizable.

Remarks:

See “*Configure columns*” (page 345).

tableview_header_height

Force the height of the header.

```
void
tableview_header_height(Tableview *view,
                        const real32_t height);
```

view The table.

height The height of the header.

Remarks:

The height of the header is automatically calculated from the content. Forcing this value may cause the table to not display correctly. Its use is not recommended. See “*Table appearance*” (page 346).

tableview_row_height

Force the height of the row.

```
void
tableview_row_height(Tableview *view,
                    const real32_t height);
```

view The table.

height The height of the row.

Remarks:

The row height is automatically calculated from the content. Forcing this value may cause the table to not display correctly. its use is not recommended. See “*Table appearance*” (page 346).

tableview_hkey_scroll

Sets the horizontal scrolling when pressing the [LEFT] and [RIGHT] keys.

```
void
tableview_hkey_scroll(Tableview *view,
                    const bool_t force_column,
                    const real32_t scroll);
```

view The table.

force_column If **TRUE** the horizontal content will scroll column by column.

scroll If force_column=**FALSE** indicates the amount in pixels that the table will be moved horizontally when pressing the cursor keys.

Remarks:

See “*Table navigation*” (page 344).

tableView_multisel

Sets the row selection mode.

```
void
tableView_multisel(tableView *view,
                  const bool_t multisel,
                  const bool_t preserve);
```

view The table.

multisel **TRUE** to allow multiple selection.

preserve **TRUE** to preserve the selection while browsing.

Remarks:

See “*Multiple selection*” (page 344).

tableView_grid

Sets the drawing of the interior lines.

```
void
tableView_grid(tableView *view,
              const bool_t hlines,
              const bool_t vlines);
```

view The table.

hlines **TRUE** to draw horizontal lines.

vlines **TRUE** to draw vertical lines.

Remarks:

See “*Table appearance*” (page 346).

tableView_update

Synchronizes the table with the data source.

```
void
tableView_update(tableView *view);
```

view The table.

Remarks:

See “*Data connection*” (page 339). We must call this function from the application whenever the data linked to the table changes, in order to update the view.

tableview_select

Selects rows in the table.

```
void
tableview_select(Tableview *view,
                 const uint32_t *rows,
                 const uint32_t n);
```

view The table.

rows Vector of line indices.

n Number of elements in the vector.

Remarks:

See “*Multiple selection*” (page 344).

tableview_deselect

Deselects rows in the table.

```
void
tableview_deselect(Tableview *view,
                   const uint32_t *rows,
                   const uint32_t n);
```

view The table.

rows Vector of line indices.

n Number of elements in the vector.

Remarks:

See “*Multiple selection*” (page 344).

tableview_deselect_all

Deselects all rows in the table.

```
void
tableview_deselect_all(Tableview *view);
```

view The table.

Remarks:

See “*Multiple selection*” (page 344).

tableview_selected

Returns the currently selected rows.

```
const ArrSt(uint32_t)*
tableview_selected(const TableView *view);
```

view The table.

Return:

Array with the indices of the selected rows.

Remarks:

See “*Multiple selection*” (page 344).

tableview_focus_row

Set keyboard focus to a specific row.

```
void
tableview_focus_row(TableView *view,
                   const uint32_t row,
                   const align_t align);
```

view The table.

row The row that will receive focus.

align Vertical adjustment.

Remarks:

Setting keyboard focus to a row only has effects on navigation, but does not involve selecting the row. The table is automatically scrolled so that the row is visible. In this case, `align` indicates where the vertical scroll is adjusted (up, down or centered). See “*Table navigation*” (page 344).

tableview_get_focus_row

Gets the row that has keyboard focus.

```
uint32_t
tableview_get_focus_row(const TableView *view);
```

view The table.

Return:

The row that has the focus.

Remarks:

See “*Table navigation*” (page 344).

tableview_scroll_visible

Show or hide scroll bars.

```
void  
tableview_scroll_visible(Tableview *view,  
                        const bool_t horizontal,  
                        const bool_t vertical);
```

view The table.

horizontal Horizontal bar.

vertical Vertical bar.

Remarks:

See “*Table appearance*” (page 346).

splitview_horizontal

Create a splitview with horizontal split.

```
SplitView*  
splitview_horizontal(void);
```

Return:

The newly created split view.

splitview_vertical

Create a splitview with vertical split.

```
SplitView*  
splitview_vertical(void);
```

Return:

The newly created split view.

splitview_size

Sets the default size of the view.

```
void
splitview_size(SplitView *split,
               const S2Df size);
```

split The view.

size The size.

Remarks:

It corresponds to the “*Natural sizing*” (page 351) of the control. Default 128x128.

splitview_view

Add a custom view to the splitview.

```
void
splitview_view(SplitView *split,
               View *view,
               const bool_t tabstop);
```

split The splitview.

view The custom view.

tabstop **TRUE** if we want the view to be part of the tablist. See “*Tabstops*” (page 359).

Remarks:

See “*Add controls*” (page 348).

splitview_text

Add a text view to the splitview.

```
void
splitview_text(SplitView *split,
               TextView *view,
               const bool_t tabstop);
```

split The splitview.

view The text view.

tabstop **TRUE** if we want the view to be part of the tablist. See “*Tabstops*” (page 359).

Remarks:

See “Add controls” (page 348).

splitview_split

Add a splitview (child) to the splitview.

```
void  
splitview_split(SplitView *split,  
                SplitView *child);
```

split The splitview.

child The splitview to add.

Remarks:

See “Add controls” (page 348).

splitview_panel

Add a panel to the splitview.

```
void  
splitview_panel(SplitView *split,  
                Panel *panel);
```

split The splitview.

panel The panel.

Remarks:

See “Add controls” (page 348).

splitview_pos

Sets the position of the view separator.

```
void  
splitview_pos(SplitView *split,  
              const real32_t pos);
```

split The splitview.

pos The new position of the separator.

Remarks:

See “Split modes” (page 349).

layout_create

Create a new layout specifying the number of columns and rows.

```
Layout*
layout_create(const uint32_t ncols,
              const uint32_t nrows);
```

ncols The number of columns.

nrows The number of rows.

Return:

The layout.

layout_cell

Get a layout cell.

```
Cell*
layout_cell(Layout *layout,
            const uint32_t col,
            const uint32_t row);
```

layout The layout.

col Column, cell x coordinate.

row Row, cell y coordinate.

Return:

The cell.

layout_control

Gets the control assigned to a cell in the layout.

```
GuiControl*
layout_control(Layout *layout,
              const uint32_t col,
              const uint32_t row);
```

layout The layout.

col Column, cell x coordinate.

row Row, cell y coordinate.

Return:

The control or `NULL`, if the cell is empty or contains a sublayout.

layout_label

Insert a `Label` control in a layout.

```
void  
layout_label(Layout *layout,  
             Label *label,  
             const uint32_t col,  
             const uint32_t row);
```

- layout The layout.
- label The control to insert.
- col Column, cell x coordinate.
- row Row, cell y coordinate.

layout_button

Insert a `Button` control in a layout.

```
void  
layout_button(Layout *layout,  
             Button *button,  
             const uint32_t col,  
             const uint32_t row);
```

- layout The layout.
- button The control to insert.
- col Column, cell x coordinate.
- row Row, cell y coordinate.

layout_popup

Insert a `PopUp` control in a layout.

```
void  
layout_popup(Layout *layout,  
            PopUp *popup,  
            const uint32_t col,  
            const uint32_t row);
```

- layout The layout.
- popup The control to insert.
- col Column, cell x coordinate.
- row Row, cell y coordinate.

layout_edit

Insert an `Edit` control in a layout.

```
void
layout_edit(Layout *layout,
            Edit *edit,
            const uint32_t col,
            const uint32_t row);
```

- layout The layout.
- edit The control to insert.
- col Column, cell x coordinate.
- row Row, cell y coordinate.

layout_combo

Insert a `Combo` control in a layout.

```
void
layout_combo(Layout *layout,
             Combo *combo,
             const uint32_t col,
             const uint32_t row);
```

- layout The layout.
- combo The control to insert.
- col Column, cell x coordinate.
- row Row, cell y coordinate.

layout_listbox

Insert a `ListBox` control in a layout.

```
void
layout_listbox(Layout *layout,
              ListBox *list,
              const uint32_t col,
              const uint32_t row);
```

- layout The layout.
- list The control to insert.
- col Column, cell x coordinate.
- row Row, cell y coordinate.

layout_updown

Insert an `UpDown` control in a layout.

```
void
layout_updown(Layout *layout,
              UpDown *updown,
              const uint32_t col,
              const uint32_t row);
```

- layout The layout.
- updown The control to insert.
- col Column, cell x coordinate.
- row Row, cell y coordinate.

layout_slider

Insert an `Slider` control in a layout.

```
void
layout_slider(Layout *layout,
              Slider *slider,
              const uint32_t col,
              const uint32_t row);
```

- layout The layout.
- slider The control to insert.
- col Column, cell x coordinate.
- row Row, cell y coordinate.

layout_progress

Insert a `Progress` control in a layout.

```
void
layout_progress(Layout *layout,
                Progress *progress,
                const uint32_t col,
                const uint32_t row);
```

- layout The layout.
- progress The control to insert.
- col Column, cell x coordinate.
- row Row, cell y coordinate.

layout_view

Insert `View` in a layout.

```
void
layout_view(Layout *layout,
            View *view,
            const uint32_t col,
            const uint32_t row);
```

- layout The layout.
- view The view to insert.
- col Column, cell x coordinate.
- row Row, cell y coordinate.

layout_textview

Insert a `TextView` control in a layout.

```
void
layout_textview(Layout *layout,
                TextView *view,
                const uint32_t col,
                const uint32_t row);
```

- layout The layout.
- view The control to insert.
- col Column, cell x coordinate.
- row Row, cell y coordinate.

layout_webview

Insert a `WebView` control in a layout.

```
void
layout_webview(Layout *layout,
               WebView *view,
               const uint32_t col,
               const uint32_t row);
```

- layout The layout.
- view The control to insert.
- col Column, cell x coordinate.
- row Row, cell y coordinate.

layout_imageview

Insert an `ImageView` control in a layout.

```
void
layout_imageview(Layout *layout,
                 ImageView *view,
                 const uint32_t col,
                 const uint32_t row);
```

- layout The layout.
- view The control to insert.
- col Column, cell x coordinate.
- row Row, cell y coordinate.

layout_tableview

Insert an `TableView` control in a layout.

```
void
layout_tableview(Layout *layout,
                 TableView *view,
                 const uint32_t col,
                 const uint32_t row);
```

- layout The layout.
- view The control to insert.
- col Column, cell x coordinate.
- row Row, cell y coordinate.

layout_splitview

Insert an `SplitView` control in a layout.

```
void
layout_splitview(Layout *layout,
                 SplitView *view,
                 const uint32_t col,
                 const uint32_t row);
```

- layout The layout.
- view The control to insert.
- col Column, cell x coordinate.
- row Row, cell y coordinate.

layout_panel

Insert a `Panel` control in a layout.

```
void
layout_panel(Layout *layout,
             Panel *panel,
             const uint32_t col,
             const uint32_t row);
```

- layout The layout.
- panel The control to insert.
- col Column, cell x coordinate.
- row Row, cell y coordinate.

layout_panel_replace

Replaces one `Panel` in a layout with another.

```
void
layout_panel_replace(Layout *layout,
                    Panel *panel,
                    const uint32_t col,
                    const uint32_t row);
```

- layout The layout.
- panel The new panel.
- col Column, cell x coordinate.
- row Row, cell y coordinate.

Remarks:

In cell (col, row) there must previously exist a panel that will be destroyed, without the possibility of recovering it. See “*Replacing panels*” (page 357).

layout_layout

Insert a layout into a cell in another layout.

```
void
layout_layout(Layout *layout,
              Layout *sublayout,
              const uint32_t col,
              const uint32_t row);
```

layout The main layout.
 sublayout The layout to insert.
 col Column, cell x coordinate.
 row Row, cell y coordinate.

layout_get_label

Gets the `Label` of a cell.

```
Label*
layout_get_label(const Layout *layout,
                const uint32_t col,
                const uint32_t row);
```

layout The layout.
 col Column, cell x coordinate.
 row Row, cell y coordinate.

Return:

The label or `NULL`, if the cell is empty or contains something else.

layout_get_button

Gets the `Button` of a cell.

```
Button*
layout_get_button(const Layout *layout,
                 const uint32_t col,
                 const uint32_t row);
```

layout The layout.
 col Column, cell x coordinate.
 row Row, cell y coordinate.

Return:

The button or `NULL`, if the cell is empty or contains something else.

layout_get_popup

Gets the `PopUp` of a cell.

```

PopUp*
layout_get_popup(const Layout *layout,
                 const uint32_t col,
                 const uint32_t row);

```

layout The layout.
 col Column, cell x coordinate.
 row Row, cell y coordinate.

Return:

The popup or `NULL`, if the cell is empty or contains something else.

layout_get_edit

Gets the `Edit` of a cell.

```

Edit*
layout_get_edit(const Layout *layout,
                const uint32_t col,
                const uint32_t row);

```

layout The layout.
 col Column, cell x coordinate.
 row Row, cell y coordinate.

Return:

The edit or `NULL`, if the cell is empty or contains something else.

layout_get_combo

Gets the `Combo` of a cell.

```

Combo*
layout_get_combo(const Layout *layout,
                 const uint32_t col,
                 const uint32_t row);

```

layout The layout.
 col Column, cell x coordinate.
 row Row, cell y coordinate.

Return:

The combo or `NULL`, if the cell is empty or contains something else.

layout_get_listbox

Gets the `ListBox` of a cell.

```
ListBox*  
layout_get_listbox(const Layout *layout,  
                  const uint32_t col,  
                  const uint32_t row);
```

layout The layout.

col Column, cell x coordinate.

row Row, cell y coordinate.

Return:

The listbox or `NULL`, if the cell is empty or contains something else.

layout_get_updown

Gets the `UpDown` of a cell.

```
UpDown*  
layout_get_updown(const Layout *layout,  
                  const uint32_t col,  
                  const uint32_t row);
```

layout The layout.

col Column, cell x coordinate.

row Row, cell y coordinate.

Return:

The updown or `NULL`, if the cell is empty or contains something else.

layout_get_slider

Gets the `Slider` of a cell.

```
Slider*  
layout_get_slider(const Layout *layout,  
                  const uint32_t col,  
                  const uint32_t row);
```

layout The layout.

col Column, cell x coordinate.

row Row, cell y coordinate.

Return:

The slider or `NULL`, if the cell is empty or contains something else.

layout_get_progress

Gets the `Progress` of a cell.

```
Progress*
layout_get_progress(const Layout *layout,
                   const uint32_t col,
                   const uint32_t row);
```

layout The layout.
 col Column, cell x coordinate.
 row Row, cell y coordinate.

Return:

The progress or `NULL`, if the cell is empty or contains something else.

layout_get_view

Gets the `View` of a cell.

```
View*
layout_get_view(const Layout *layout,
                const uint32_t col,
                const uint32_t row);
```

layout The layout.
 col Column, cell x coordinate.
 row Row, cell y coordinate.

Return:

The view or `NULL`, if the cell is empty or contains something else.

layout_get_textview

Gets the `TextView` of a cell.

```
TextView*
layout_get_textview(const Layout *layout,
                   const uint32_t col,
                   const uint32_t row);
```

layout The layout.
col Column, cell x coordinate.
row Row, cell y coordinate.

Return:

The textview or `NULL`, if the cell is empty or contains something else.

layout_get_webview

Gets the `WebView` of a cell.

```
WebView*  
layout_get_webview(const Layout *layout,  
                  const uint32_t col,  
                  const uint32_t row);
```

layout The layout.
col Column, cell x coordinate.
row Row, cell y coordinate.

Return:

The webview or `NULL`, if the cell is empty or contains something else.

layout_get_imageview

Gets the `ImageView` of a cell.

```
ImageView*  
layout_get_imageview(const Layout *layout,  
                    const uint32_t col,  
                    const uint32_t row);
```

layout The layout.
col Column, cell x coordinate.
row Row, cell y coordinate.

Return:

The imageview or `NULL`, if the cell is empty or contains something else.

layout_get_tableview

Gets the `TableView` of a cell.

```

TableView*
layout_get_tableview(const Layout *layout,
                    const uint32_t col,
                    const uint32_t row);

```

layout The layout.
 col Column, cell x coordinate.
 row Row, cell y coordinate.

Return:

The tableview or `NULL`, if the cell is empty or contains something else.

layout_get_splitview

Gets the `SplitView` of a cell.

```

SplitView*
layout_get_splitview(const Layout *layout,
                    const uint32_t col,
                    const uint32_t row);

```

layout The layout.
 col Column, cell x coordinate.
 row Row, cell y coordinate.

Return:

The splitview or `NULL`, if the cell is empty or contains something else.

layout_get_panel

Gets the `Panel` of a cell.

```

Panel*
layout_get_panel(const Layout *layout,
                const uint32_t col,
                const uint32_t row);

```

layout The layout.
 col Column, cell x coordinate.
 row Row, cell y coordinate.

Return:

The panel or `NULL`, if the cell is empty or contains something else.

layout_get_layout

Gets the `Layout` of a cell.

```
Layout*
layout_get_layout(const Layout *layout,
                 const uint32_t col,
                 const uint32_t row);
```

layout The layout.
 col Column, cell x coordinate.
 row Row, cell y coordinate.

Return:

The sublayout or `NULL`, if the cell is empty or contains something else.

layout_ncols

Gets the number of columns in the layout.

```
uint32_t
layout_ncols(const Layout *layout);
```

layout The layout.

Return:

Number of columns.

Remarks:

See “*Dynamic layouts*” (page 357).

layout_nrows

Gets the number of rows in the layout.

```
uint32_t
layout_nrows(const Layout *layout);
```

layout The layout.

Return:

Number of rows.

Remarks:

See “*Dynamic layouts*” (page 357).

layout_insert_col

Insert a new column into the layout.

```
void
layout_insert_col(Layout *layout,
                  const uint32_t col);
```

layout The layout.

col Position of the new column (0, ncols).

Remarks:

Empty cells are inserted that will not affect the layout of the window. See “*Dynamic layouts*” (page 357).

layout_insert_row

Insert a new row into the layout.

```
void
layout_insert_row(Layout *layout,
                  const uint32_t row);
```

layout The layout.

row Position of the new row (0, nrows).

Remarks:

Empty cells are inserted that will not affect the layout of the window. See “*Dynamic layouts*” (page 357).

layout_remove_col

Deletes an existing column in the layout.

```
void
layout_remove_col(Layout *layout,
                  const uint32_t col);
```

layout The layout.

col Position of the column to delete (0, ncols-1).

Remarks:

All cell content (controls/sub-layouts) is irreversibly deleted. See “*Dynamic layouts*” (page 357).

layout_remove_row

Deletes an existing row in the layout.

```
void
layout_remove_row(Layout *layout,
                  const uint32_t row);
```

layout The layout.

row Position of the row to delete (0, nrow-1).

Remarks:

All cell content (controls/sub-layouts) is irreversibly deleted. See “*Dynamic layouts*” (page 357).

layout_taborder

Set how the keyboard focus will move when you press [TAB].

```
void
layout_taborder(Layout *layout,
                 const gui_orient_t order);
```

layout The layout.

order Loop through rows or columns.

Remarks:

See “*Tabstops*” (page 359).

layout_tabstop

Sets whether or not a cell in the layout will receive keyboard focus when navigating with [TAB] - [SHIFT] [TAB].

```
void
layout_tabstop(Layout *layout,
               const uint32_t col,
               const uint32_t row,
               const bool_t tabstop);
```

layout The layout.

col Column, cell x coordinate.

row Row, cell y coordinate.

tabstop Enable or disable cell tabstop.

Remarks:

See “*Tabstops*” (page 359).

layout_hsize

Set a fixed width for a layout column.

```
void
layout_hsize(Layout *layout,
             const uint32_t col,
             const real32_t width);
```

layout The layout.

col Column index.

width Width.

layout_vsize

Force a fixed height for the layout row.

```
void
layout_vsize(Layout *layout,
             const uint32_t row,
             const real32_t height);
```

layout The layout.

row Row index.

height Height.

layout_hmargin

Establish an inter-column margin within the layout. It is the separation between two consecutive columns.

```
void
layout_hmargin(Layout *layout,
              const uint32_t col,
              const real32_t margin);
```

layout The layout.

col Index of the column. The index 0 refers to the separation between column 0 and column 1. `ncols-2` is the maximum accepted value.

margin Margin.

layout_vmargin

Set an inter-row margin within the layout. It is the separation between two consecutive rows.

```
void
layout_vmargin(Layout *layout,
               const uint32_t row,
               const real32_t margin);
```

layout The layout.

row Row index Index 0 refers to the separation between row 0 and row 1. nrows-2 is the maximum accepted value.

margin Margin.

layout_hexpand

Set the column to expand horizontally.

```
void
layout_hexpand(Layout *layout,
               const uint32_t col);
```

layout The layout.

col Column index.

Remarks:

See “*Cell expansion*” (page 355).

layout_hexpand2

Set the two columns that will expand horizontally.

```
void
layout_hexpand2(Layout *layout,
                const uint32_t col1,
                const uint32_t col2,
                const real32_t exp);
```

layout The layout.

col1 Index of column 1.

col2 Index of column 2.

exp Expansion of col1 between 0 and 1.

Remarks:

The expansion of `col2 = 1 - exp`. See “*Cell expansion*” (page 355).

layout_hexpand3

Set the three columns that will expand horizontally.

```
void
layout_hexpand3(Layout *layout,
                const uint32_t col1,
                const uint32_t col2,
                const uint32_t col3,
                const real32_t exp1,
                const real32_t exp2);
```

- layout The layout.
- col1 Index of column 1.
- col2 Index of column 2.
- col3 Index of column 3.
- exp1 Expansion of `col1` between 0 and 1.
- exp2 Expansion of `col2` between 0 and 1.

Remarks:

$exp1 + exp2 < = 1$. The expansion of `col3 = 1 - exp1 - exp2`. See “*Cell expansion*” (page 355).

layout_vexpand

Set the row that will expand vertically.

```
void
layout_vexpand(Layout *layout,
               const uint32_t row);
```

- layout The layout.
- row Row index.

Remarks:

See “*Cell expansion*” (page 355).

layout_vexpand2

Set the two rows that will expand vertically.

```
void
layout_vexpand2(Layout *layout,
                const uint32_t row1,
                const uint32_t row2,
                const real32_t exp);
```

- layout The layout.
- row1 Index of row 1.
- row2 Index of row 2.
- exp Expansion of row1 between 0 and 1.

Remarks:

The expansion of row2 = 1 - exp. See “*Cell expansion*” (page 355).

layout_vexpand3

Set the three rows that will expand horizontally.

```
void
layout_vexpand3(Layout *layout,
                const uint32_t row1,
                const uint32_t row2,
                const uint32_t row3,
                const real32_t exp1,
                const real32_t exp2);
```

- layout The layout.
- row1 Index of row 1.
- row2 Index of row 2.
- row3 Index of row 3.
- exp1 Expansion of row1 between 0 and 1.
- exp2 Expansion of row2 between 0 and 1.

Remarks:

$exp1 + exp2 < = 1$. The expansion of row3 = 1 - exp1 - exp2. See “*Cell expansion*” (page 355).

layout_halign

Sets the horizontal alignment of a cell. It will take effect when the column is wider than the cell.

```
void
layout_halign(Layout *layout,
              const uint32_t col,
              const uint32_t row,
              const align_t align);
```

layout The layout.
 col Column, cell x coordinate.
 row Row, cell y coordinate.
 align Horizontal alignment.

layout_valign

Sets the vertical alignment of a cell. It will take effect when the row is taller than the cell.

```
void
layout_valign(Layout *layout,
              const uint32_t col,
              const uint32_t row,
              const align_t align);
```

layout The layout.
 col Column, cell x coordinate.
 row Row, cell y coordinate.
 align Vertical alignment.

layout_show_col

Show or hide a layout column.

```
void
layout_show_col(Layout *layout,
                const uint32_t col,
                const bool_t visible);
```

layout The layout.
 col Column index.
 visible Visible or hidden.

layout_show_row

Show or hide a layout row.

```
void
layout_show_row(Layout *layout,
                const uint32_t row,
                const bool_t visible);
```

layout The layout.

row Row index.

visible Visible or hidden.

layout_margin

Set a uniform margin for the layout border.

```
void
layout_margin(Layout *layout,
              const real32_t mall);
```

layout The layout.

mall Margin for all four sides (left, right, up and down).

layout_margin2

Set a horizontal and vertical margin for the layout edge.

```
void
layout_margin2(Layout *layout,
               const real32_t mtb,
               const real32_t mlr);
```

layout The layout.

mtb Upper and lower margin.

mlr Left and right margin.

layout_margin4

Set margins for the layout border.

```
void
layout_margin4(Layout *layout,
               const real32_t mt,
               const real32_t mr,
               const real32_t mb,
               const real32_t ml);
```

- layout The layout.
- mt Top edge margin.
- mr Right edge margin.
- mb Bottom edge margin.
- ml Left edge margin.

layout_bgcolor

Assign a background color to the layout.

```
void
layout_bgcolor(Layout *layout,
               const color_t color);
```

- layout The layout.
- color The color. With `ekCOLOR_TRANSPARENT` default color is restored.

layout_skcolor

Assign a color to the edge of the layout.

```
void
layout_skcolor(Layout *layout,
               const color_t color);
```

- layout The layout.
- color The color. With `ekCOLOR_TRANSPARENT` default color is restored.

layout_update

Update the window associated with the layout.

```
void
layout_update(Layout *layout);
```

- layout The layout.

Remarks:

It is equivalent to calling `window_update`.

layout_dbind

Associate a type struct with a layout.

```
void
layout_dbind(Layout *layout,
             Listener *listener,
             type);
```

layout The layout.

listener Will notify through this `listener` every time the object changes. Can be `NULL`.

type The `struct` type.

Remarks:

See “*GUI Data binding*” (page 377).

layout_dbind_obj

Associate an object with a layout to view and edit it.

```
void
layout_dbind_obj(Layout *layout,
                 type *obj,
                 type);
```

layout The layout.

obj The object to edit.

type Object type.

Remarks:

See “*GUI Data binding*” (page 377).

layout_dbind_update

Updates the interface of the object associated with the layout.

```
void
layout_dbind_update(Layout *layout,
                   type,
                   mtype,
                   mname);
```

layout The layout.
 type The object type.
 mtype The type of the field to update.
 mname The name of the field to update.

Remarks:

See “*GUI Data binding*” (page 377).

cell_empty

Check if the cell is empty.

```
bool_t
cell_empty(Cell *cell);
```

cell The cell.

Return:

TRUE if the cell is empty.

cell_control

Get control of the inside of the cell.

```
GuiControl*
cell_control(Cell *cell);
```

cell The cell.

Return:

The control or **NULL**, if the cell is empty or contains a sublayout.

cell_label

Get the label inside the cell.

```
Label*
cell_label(Cell *cell);
```

cell The cell.

Return:

The label or **NULL**, if the cell is empty or contains something else.

cell_button

Get the button inside the cell.

```
Button*  
cell_button(Cell *cell);
```

cell The cell.

Return:

The button or **NULL**, if the cell is empty or contains something else.

cell_popup

Get the popup inside the cell.

```
PopUp*  
cell_popup(Cell *cell);
```

cell The cell.

Return:

The popup or **NULL**, if the cell is empty or contains something else.

cell_edit

Get the edit inside the cell.

```
Edit*  
cell_edit(Cell *cell);
```

cell The cell.

Return:

The edit or **NULL**, if the cell is empty or contains something else.

cell_combo

Get the combo inside the cell.

```
Combo*  
cell_combo(Cell *cell);
```

cell The cell.

Return:

The combo or **NULL**, if the cell is empty or contains something else.

cell_listbox

Get the listbox inside the cell.

```
ListBox*
cell_listbox(Cell *cell);
```

cell The cell.

Return:

The listbox or **NULL**, if the cell is empty or contains something else.

cell_updown

Get the updown inside the cell.

```
UpDown*
cell_updown(Cell *cell);
```

cell The cell.

Return:

The updown or **NULL**, if the cell is empty or contains something else.

cell_slider

Get the slider inside the cell.

```
Slider*
cell_slider(Cell *cell);
```

cell The cell.

Return:

The slider or **NULL**, if the cell is empty or contains something else.

cell_progress

Get the progress inside the cell.

```
Progress*
cell_progress(Cell *cell);
```

cell The cell.

Return:

The progress or **NULL**, if the cell is empty or contains something else.

cell_view

Get the view inside the cell.

```
View*  
cell_view(Cell *cell);
```

cell The cell.

Return:

The view or **NULL**, if the cell is empty or contains something else.

cell_textview

Get the textview inside the cell.

```
TextView*  
cell_textview(Cell *cell);
```

cell The cell.

Return:

The textview or **NULL**, if the cell is empty or contains something else.

cell_webview

Get the webview inside the cell.

```
WebView*  
cell_webview(Cell *cell);
```

cell The cell.

Return:

The webview or **NULL**, if the cell is empty or contains something else.

cell_imageview

Get the imageview inside the cell.

```
ImageView*  
cell_imageview(Cell *cell);
```

cell The cell.

Return:

The imageview or **NULL**, if the cell is empty or contains something else.

cell_tableview

Get the tableview inside the cell.

```
TableView*
cell_tableview(Cell *cell);
```

cell The cell.

Return:

The tableview or **NULL**, if the cell is empty or contains something else.

cell_splitview

Get the splitview inside the cell.

```
SplitView*
cell_splitview(Cell *cell);
```

cell The cell.

Return:

The splitview or **NULL**, if the cell is empty or contains something else.

cell_panel

Get the panel inside the cell.

```
Panel*
cell_panel(Cell *cell);
```

cell The cell.

Return:

The panel or **NULL**, if the cell is empty or contains something else.

cell_layout

Get the layout inside the cell.

```
Layout*
cell_layout(Cell *cell);
```

cell The cell.

Return:

The layout or **NULL**, if the cell is empty or contains something else.

cell_enabled

Activate or deactivate a cell.

```
void
cell_enabled(Cell *cell,
             const bool_t enabled);
```

cell The cell.

enabled Enabled or not.

Remarks:

If the cell contains a sublayout, the command will affect all controls recursively.

cell_visible

Show or hide a cell.

```
void
cell_visible(Cell *cell,
             const bool_t visible);
```

cell The cell.

visible Visible or not.

Remarks:

If the cell contains a sublayout, the command will affect all controls recursively.

cell_padding

Set an inner margin.

```
void
cell_padding(Cell *cell,
             const real32_t pall);
```

cell The cell.

pall Inner margin.

cell_padding2

Set an inner margin.

```
void
cell_padding2(Cell *cell,
             const real32_t ptb,
```

```
const real32_t plr);
```

- cell The cell.
- ptb Upper and lower margin.
- plr Left and right margin.

cell_padding4

Set an inner margin.

```
void
cell_padding4(Cell *cell,
              const real32_t pt,
              const real32_t pr,
              const real32_t pb,
              const real32_t pl);
```

- cell The cell.
- pt Top margin.
- pr Right margin.
- pb Bottom margin.
- pl Left margin.

cell_dbind

Associates a cell with the field of a struct.

```
void
cell_dbind(Cell *cell,
           type,
           mtype,
           mname);
```

```
cell_dbind(cell, Product, String*, description);
```

- cell The cell.
- type The **struct** type.
- mtype The **struct** field type.
- mname Field name.

Remarks:

See “*GUI Data binding*” (page 377).

panel_create

Create a panel.

```
Panel*
panel_create(void);
```

Return:

The new panel.

panel_scroll

Create a panel with scroll bars.

```
Panel*
panel_scroll(const bool_t hscroll,
             const bool_t vscroll);
```

hscroll **TRUE** if we want horizontal scroll bar.

vscroll **TRUE** if we want vertical scroll bar.

Return:

The new panel.

Remarks:

See “*Understanding panel sizing*” (page 363).

panel_custom

Create a fully configurable panel.

```
Panel*
panel_custom(const bool_t hscroll,
             const bool_t vscroll,
             const bool_t border);
```

hscroll **TRUE** if we want horizontal scroll bar.

vscroll **TRUE** if we want vertical scroll bar.

border **TRUE** if we want to highlight the border.

Return:

The new panel.

Remarks:

See “*Understanding panel sizing*” (page 363).

panel_data

Associate user data with the panel.

```
void
panel_data(Panel *panel,
           type **data,
           FPtr_destroy func_destroy_data,
           type);
```

panel The panel.

data User data.

func_destroy_data Destructor of user data. It will be called when the panel is destroyed.

type Type of user data.

panel_get_data

Get the user data associated with the panel.

```
type*
panel_get_data(const Panel *panel,
              type);
```

panel The panel.

type Type of user data.

Return:

User data.

panel_size

Sets the default size of the visible area of a panel.

```
void
panel_size(Panel *panel,
          const S2Df size);
```

panel The panel.

size The default size.

Remarks:

See “*Understanding panel sizing*” (page 363).

panel_layout

Add a layout to a panel.

```
uint32_t
panel_layout (Panel *panel,
              Layout *layout);
```

panel The panel.

layout Layout.

Return:

The newly added layout index.

panel_get_layout

Get a layout of a panel.

```
Layout*
panel_get_layout (Panel *panel,
                  const uint32_t index);
```

panel The panel.

index The layout index.

Return:

Layout.

panel_visible_layout

Set the active layout inside the panel.

```
void
panel_visible_layout (Panel *panel,
                     const uint32_t index);
```

panel The panel.

index The layout index.

Remarks:

To make the change effective, you have to call `panel_update`.

panel_update

Update the window that contains the panel.

```
void
panel_update (Panel *panel);
```

panel The panel.

Remarks:

It is equivalent to calling `window_update`.

panel_scroll_width

Gets the width of the scroll bar of the associated panel.

```
real32_t
panel_scroll_width (const Panel *panel);
```

panel The panel.

Return:

The width of the bar.

Remarks:

Only valid if the panel has been created with `panel_scroll`. Useful if we want to take into account the size of the scroll bars when setting the margins of the Layout.

panel_scroll_height

Gets the height of the scroll bar.

```
real32_t
panel_scroll_height (const Panel *panel);
```

panel The panel.

Return:

The height of the bar.

Remarks:

See `panel_scroll_width`.

window_create

Create a new window.

```
Window*
window_create(const uint32_t flags);
```

flags Combination of `window_flag_t` values.

Return:

The window.

window_destroy

Destroy the window and all its contents.

```
void
window_destroy(Window **window);
```

window The window. Will be set to `NULL` after destruction.

Remarks:

Panels, layouts and components will be recursively destroyed.

window_panel

Associate the main panel with a window.

```
void
window_panel(Window *window,
             Panel *panel);
```

window The window.

panel Main panel, which integrates all the content of the window (views, controls, etc).

Remarks:

The size of the window will be adjusted based on the “*Natural sizing*” (page 351) of the main panel.

window_OnClose

Set an event handler for the window closing.

```
void
window_OnClose(Window *window,
               Listener *listener);
```

window The window.

listener *Callback* function to be called before closing a window.

Remarks:

See “*Closing the window*” (page 369).

window_OnMoved

Set an event handler for moving the window on the desktop.

```
void
window_OnMoved(Window *window,
               Listener *listener);
```

window The window.

listener *Callback* function to be called as the title bar is dragged and the window moves across the desktop.

Remarks:

See “*GUI Events*” (page 308).

window_OnResize

Set an event handler for window resizing.

```
void
window_OnResize(Window *window,
                Listener *listener);
```

window The window.

listener *Callback* function to be called as the outer edges of the window are dragged to resize.

Remarks:

The resizing and relocation of elements is done automatically based on the main `Layout`, so it is not usually necessary for the application to respond to this event. See “*GUI Events*” (page 308).

window_title

Set the text that will display the window in the title bar.

```
void
window_title(Window *window,
```

```
const char_t *text);
```

window The window.

text UTF8 C-string terminated in null character '\0'.

window_show

Show the window. By default windows are created hidden. You have to show them explicitly.

```
void
window_show(Window *window);
```

window The window.

window_hide

Hide the window.

```
void
window_hide(Window *window);
```

window The window.

window_overlay

Launch an overlay window.

```
void
window_overlay(Window *window,
               Window *parent);
```

window The window.

parent The main window.

Remarks:

See “*Overlay windows*” (page 372).

window_modal

Launch a window in **modal** mode.

```
uint32_t
window_modal(Window *window,
             Window *parent);
```

window The window.
 parent The parent window.

Return:

Value returned by `window_stop_modal`.

Remarks:

parent stop receiving events until you call `window_stop_modal`. See “*Modal windows*” (page 370).

window_stop_modal

Ends the **modal** cycle of a window.

```
void
window_stop_modal(Window *window,
                  const uint32_t return_value);
```

window The window previously launched with `window_modal`.
 return_value Value to be returned `window_modal`.

Remarks:

See “*Modal windows*” (page 370).

window_hotkey

Sets an action associated with pressing a key.

```
void
window_hotkey(Window *window,
              const vkey_t key,
              const uint32_t modifiers,
              Listener *listener);
```

window The window.
 key The key.
 modifiers Modifiers. 0 or combination of `mkey_t`.
 listener Handler of the event associated with the key press. If `NULL`, removes the event associated with the key (if one exists).

Remarks:

See “*Keyboard shortcuts*” (page 375).

window_clear_hotkeys

Removes all keyboard shortcuts associated with the window.

```
void  
window_clear_hotkeys(Window *window);
```

window The window.

Remarks:

See “*Keyboard shortcuts*” (page 375).

window_cycle_tabstop

Activate or deactivate the cyclic behavior of tabstops.

```
void  
window_cycle_tabstop(Window *window,  
                     const bool_t cycle);
```

window The window.

cycle **TRUE** to activate cycles in tabstops (default).

Remarks:

See “*Tablist without cycles*” (page 375).

window_next_tabstop

Moves keyboard focus to the next control in the *tab-list*. It has the same effect as pressing [TAB].

```
gui_focus_t  
window_next_tabstop(Window *window);
```

window The window.

Return:

Result of the focus change operation.

Remarks:

See “*Focus change*” (page 374).

window_previous_tabstop

Moves the keyboard focus to the previous control in the *tab-list*. This has the same effect as pressing [SHIFT]+[TAB].

```
gui_focus_t
window_previous_tabstop(Window *window);
```

window The window.

Return:

Result of the focus change operation.

Remarks:

See “*Focus change*” (page 374).

window_focus

Set keyboard focus to a specific control.

```
gui_focus_t
window_focus(Window *window,
             GuiControl *control);
```

window The window.

control The control that will receive the focus.

Return:

Result of the focus change operation.

Remarks:

See “*Focus change*” (page 374).

window_get_focus

Gets the control that keyboard focus has.

```
GuiControl*
window_get_focus(Window *window);
```

window The window.

Return:

The control.

window_focus_info

Gets additional information about a keyboard focus change operation.

```
void
window_focus_info(Window *window,
                  FocusInfo *info);
```

window The ventana.

info Structure where the operation data will be returned.

Remarks:

Sometimes the decision to release keyboard focus for a control requires context information. For example, what action caused the change (press [TAB], click on another control) or what control will receive the focus. See “*Focus protocol*” (page 374).

window_update

Recalculate the position and size of the controls after modifying any `Layout`.

```
void
window_update(Window *window);
```

window The window.

window_origin

Move the window to specific desktop coordinates.

```
void
window_origin(Window *window,
              const V2Df origin);
```

window The window.

origin Position (x, y) of the upper-left corner of the window.

window_size

Set the size of the client area of the window.

```
void
window_size(Window *window,
            const S2Df size);
```

window The window.

size Main panel size.

Remarks:

The final size will depend on the window frame and desktop theme settings. This measure only refers to the interior area.

window_get_origin

Get the window position.

```
V2Df
window_get_origin(const Window *window);
```

window The window.

Return:

Position (x, y) from the upper-left corner of the window.

window_get_size

Get the total dimensions of the window.

```
S2Df
window_get_size(const Window *window);
```

window The window.

Return:

Window size.

Remarks:

The frame and title bar are taken into account.

window_get_client_size

Get the dimensions of the client area of the window.

```
S2Df
window_get_client_size(const Window *window);
```

window The window.

Return:

Main panel size.

window_control_frame

Gets the position and size of a control in window coordinates.

```
R2Df
window_control_frame(const Window *window,
                    const GuiControl *control);
```

window The window.

control The control.

Return:

Frame in window coordinates.

Remarks:

control must belong to the window, be active and visible. The point (0,0) corresponds to the upper left vertex of the **client area** of the window. See “*Overlay windows*” (page 372).

window_client_to_screen

Transforms a point expressed in window coordinates to screen coordinates.

```
V2Df
window_client_to_screen(const Window *window,
                      const V2Df point);
```

window The window.

point The point in window coordinates.

Return:

The point in screen coordinates.

Remarks:

point is an inner point, where (0,0) corresponds to the top left vertex of the **client area** of the window. See “*Overlay windows*” (page 372).

window_defbutton

Set the default window button. It will be activated when pressed [Intro].

```
void
window_defbutton(Window *window,
                 Button *button);
```

window The window.

button The button.

Remarks:

This function disables the possible previous default button. For the new button to be set, it must exist in the active layout, which requires this function to be called after `window_panel`. See “Default button” (page 375).

window_cursor

Change the mouse cursor.

```
void
window_cursor(Window *window,
               const gui_cursor_t cursor,
               const Image *image,
               const real32_t hot_x,
               const real32_t hot_y);
```

window The window.

cursor Identifier of the new cursor.

image Custom image. Only valid in `ekGUI_CURSOR_USER`.

hot_x The x coordinate of the click point. Only valid in `ekGUI_CURSOR_USER`.

hot_y The y coordinate of the click point. Only valid in `ekGUI_CURSOR_USER`.

Remarks:

`hot_x`, `hot_y` indicate the “sensitive” point within the image, which will indicate the exact position of the mouse.

menu_create

Create a new menu.

```
Menu*
menu_create(void);
```

Return:

The new menu.

menu_destroy

Destroy a menu and its entire hierarchy.

```
void
menu_destroy(Menu **menu);
```

menu The menu. Will be set to `NULL` after destruction.

menu_launch

Launch a menu as secondary or *PopUp*.

```
void
menu_launch(Menu *menu,
            const V2Df position);
```

menu The menu.

position Coordinates of the upper left corner.

menu_hide

Hides a secondary *PopUp* menu.

```
void
menu_hide(Menu *menu);
```

menu The menu.

menu_item

Add an item to the menu.

```
void
menu_item(Menu *menu,
          MenuItem *item);
```

menu The menu.

item The item to add.

menu_off_items

Set status `ekGUI_OFF` for all menu items.

```
void
menu_off_items(Menu *menu);
```

menu The menu.

menu_get_item

Get an item from the menu.

```
MenuItem*
menu_get_item(Menu *menu,
              const uint32_t index);
```

menu The menu.

index The index of the item.

Return:

The item.

menu_size

Gets the number of items.

```
uint32_t
menu_size(const Menu *menu);
```

menu The menu.

Return:

Number of items.

menuitem_create

Create a new item for a menu.

```
MenuItem*
menuitem_create(void);
```

Return:

The newly item.

menuitem_separator

Create a new separator for a menu.

```
MenuItem*
menuitem_separator(void);
```

Return:

The newly item.

menuItem_OnClick

Set an event handle for item click.

```
void
menuItem_OnClick(MenuItem *item,
                 Listener *listener);
```

item The item.

listener *Callback* function to be called after clicking.

Remarks:

See “*GUI Events*” (page 308).

menuItem_enabled

Enables or disables a menu item.

```
void
menuItem_enabled(MenuItem *item,
                 const bool_t enabled);
```

item The item.

enabled Enabled or not.

menuItem_visible

Show or hide a menu item.

```
void
menuItem_visible(MenuItem *item,
                 const bool_t enabled);
```

item The item.

enabled Enabled or not.

menuItem_text

Set the item text.

```
void
menuItem_text(MenuItem *item,
              const char_t *text);
```

item The item.

text UTF8 C-string terminated in null character '\0'.

menuItem_image

Set the icon that will display the item.

```
void
menuItem_image(MenuItem *item,
               const Image *image);
```

item The item.

image Image.

menuItem_key

Set a keyboard shortcut to select the menu item.

```
void
menuItem_key(MenuItem *item,
             const vkey_t key,
             const uint32_t modifiers);
```

item The item.

key Key code.

modifiers Modifiers.

menuItem_submenu

Assign a drop-down submenu when selecting the item.

```
void
menuItem_submenu(MenuItem *item,
                Menu **submenu);
```

item The item.

submenu The submenu.

menuItem_state

Set the status of the item, which will be reflected with a mark next to the text.

```
void
menuItem_state(MenuItem *item,
              const gui_state_t state);
```

item The item.

state State.

comwin_open_file

Launch the open file dialog.

```
const char_t*
comwin_open_file(Window *parent,
                 const char_t **ftypes,
                 const uint32_t size,
                 const char_t *start_dir);
```

parent Parent window.

ftypes File types for the filter.

size Number of file types.

start_dir Start directory of the dialog. It can be `NULL`.

Return:

The name of the selected file or `NULL` if the user has aborted the dialog.

Remarks:

It will be launched in **modal**. `parent` will remain locked until the dialog is accepted.

comwin_save_file

Launch the save file dialog.

```
const char_t*
comwin_save_file(Window *parent,
                 const char_t **ftypes,
                 const uint32_t size,
                 const char_t *start_dir);
```

parent Parent window.

ftypes File types for the filter.

size Number of file types.

start_dir Start directory of the dialog. It can be `NULL`.

Return:

The name of the selected file or `NULL` if the user has aborted the dialog.

Remarks:

It will be launched **modal**. `parent` will remain locked until the dialog is accepted.

comwin_color

Launch the color selection dialog.

```
void
comwin_color(Window *parent,
             const real32_t x,
             const real32_t y,
             const align_t halign,
             const align_t valign,
             const color_t current,
             color_t *colors,
             const uint32_t n,
             Listener *OnChange);
```

```
static void i_OnColorChange(App *app, Event *e)
{
    color_t *color = event_params(e, color_t);
    // Do something
    ...
}
```

```
comwin_color(window, "Select color", 100, 50, ekRIGHT, ekTOP, kCOLOR_BLUE, NULL
↔ , 0, listener(app, i_OnColorChange, App));
```

parent Parent window.

x Initial x position.

y Initial y position.

halign Horizontal alignment with respect to x.

valign Vertical alignment with respect to y.

current Current color the panel will display.

colors Custom colors that the panel will show and that can also be edited. It can be `NULL` only if `n = 0`.

n Number of custom colors.

OnChange *Callback* function to be called after each color change.

Remarks:

On Windows and Linux systems the dialog will be launched modally and must be accepted for a color change notification to occur via `OnChange`. On macOS, notifications will be launched continuously as the dialog is manipulated.

OSApp library

44.1. Functions

FPtr_app_create

An application constructor prototype.

```
type*
(*FPtr_app_create) (void);
```

Return:

Application object.

FPtr_app_update

Function prototype for update a synchronous application.

```
void
(*FPtr_app_update) (type *app,
                   const real64_t prtime,
                   const real64_t ctime);
```

app Application object.

prtime Previous update time.

ctime Current time.

FPtr_task_main

Function prototype for start a task.

```
uint32_t
(*FPtr_task_main) (type *data);
```

data Initial task data.

Return:

Task return value.

FPtr_task_update

Function prototype of a task update.

```
void  
(*FPtr_task_update) (type *data);
```

data Task data.

FPtr_task_end

Function prototype of a task completion.

```
void  
(*FPtr_task_end) (type *data,  
                  const uint32_t rvalue);
```

data Task Data.

rvalue Task return value.

osmain

Start a desktop application.

```
void  
osmain(FPtr_app_create func_create,  
        FPtr_destroy func_destroy,  
        const char_t *options,  
        type);
```

func_create Application object constructor.

func_destroy Application object destructor.

options Options string.

type Type of application object.

Remarks:

In “Hello World!” (page 23) you have a simple example of desktop application.

osmain_sync

Start a synchronous desktop application.

```
void
osmain_sync(const real64_t lframe,
            FPtr_app_create func_create,
            FPtr_app_destroy func_destroy,
            FPtr_app_update func_update,
            const char_t *options,
            type);
```

lframe Time in seconds of the update interval (0.04 = 25 fps).

func_create Application object constructor.

func_destroy Application object destructor.

func_update Function to be called in each update interval.

options Options string.

type Type of application object.

Remarks:

See “*Synchronous applications*” (page 397).

osapp_finish

End a desktop application, destroying the message cycle and the application object.

```
void
osapp_finish(void);
```

osapp_argc

Gets the number of parameters of the command that the application ran. It is the argc value of the main() function.

```
uint32_t
osapp_argc(void);
```

Return:

The number of parameters.

osapp_argv

Gets one of the arguments of the command that the application ran. It is the argv value of the main() function.

```
uint32_t
osapp_argv(const uint32_t index,
           char_t *argv,
           const uint32_t size);
```

```
uint32_t i, n = osapp_argc();
bstd_printf("Number of args: %d\n", n);
for (i = 0; i < n; ++i)
{
    char_t argv[128];
    uint32_t nb = osapp_argv(i, argv, sizeof(argv));
    bstd_printf("argv[%d]: %s (%d bytes)\n", i, argv, nb);
}
```

index The index of the parameter.

argv Buffer where the parameter will be written.

size Number of maximum bytes in argv.

Return:

The number of bytes written to argv, including the null character '\0'.

osapp_task

Launch a task in parallel, avoiding the thread lock that controls the user interface.

```
void
osapp_task(type *data,
           const real32_t uptime,
           FPtr_task_main func_main,
           FPtr_task_update func_update,
           FPtr_task_end func_end,
           type);
```

data Initial task data.

uptime Update interval time, if required.

func_main Task start function.

func_update Task update function.

func_end Function to be called when finishing the task.

type Type of initial task data.

Remarks:

See “*Multi-threaded tasks*” (page 398).

osapp_menubar

Set the general menu bar of the application.

```
void  
osapp_menubar(Menu *menu,  
              Window *window);
```

menu The menu.

window The window that will host the menu.

Remarks:

In macOS the application menu is not linked to any window.

osapp_open_url

Open an Internet address using the default operating system browser.

```
void  
osapp_open_url(const char_t *url);
```

url URL address.

INet library

45.1. Types and Constants

enum ierror_t

Error codes of network connections.

- `ekINET` There is no internet connection on the device.
- `ekINOHOST` Unable to connect to the remote server.
- `ekITIMEOUT` Maximum timeout for connection has been exceeded.
- `ekISTREAM` Error in the I/O channel when reading or writing.
- `ekISERVER` Error in server response format.
- `ekINOIMPL` Functionality not implemented.
- `ekIUNDEF` Undetermined error.
- `ekIOK` No error.

struct Http

Manage an HTTP connection initiated from the client process.

```
struct Http;
```

struct Url

Allows access to individual fields of a URL (web address) “*URL*” (page 411).

```
struct Url;
```

struct JsonOpts

Options when processing a JSON script.

```
struct JsonOpts;
```

45.2. Functions

http_create

Create an HTTP session.

```
Http*
http_create(const char_t *host,
            const uint16_t port);
```

host Server name.

port Connection port. If we pass `UINT16_MAX` it will use 80 (by default for HTTP).

Return:

HTTP session.

http_secure

Create an HTTPS session.

```
Http*
http_secure(const char_t *host,
            const uint16_t port);
```

host Server name.

port Connection port. If we pass `UINT16_MAX` it will use 413 (by default for HTTPS).

Return:

HTTP session.

http_destroy

Destroy an HTTP object.

```
void
http_destroy(Http **http);
```

http The HTTP object. Will be set to `NULL` after destruction.

http_clear_headers

Remove previously assigned HTTP headers.

```
void
http_clear_headers(Http *http);
```

http HTTP session.

http_add_header

Add a header to the HTTP request.

```
void
http_add_header(Http *http,
                const char_t *name,
                const char_t *value);
```

http HTTP session.

name The name of the header.

value The header value.

http_get

Make a GET request.

```
bool_t
http_get(Http *http,
         const char_t *path,
         const byte_t *data,
         const uint32_t size,
         ierror_t *error);
```

http HTTP session.

path Resource.

data Data to add in the body of the request. It can be `NULL`.

size Data block size in bytes.

error Error code if the function fails. It can be `NULL`.

Return:

`TRUE` if the request has been processed correctly. If `FALSE`, in error we will have the cause.

Remarks:

The request is synchronous, that is, the program will be stopped until the server responds. If we want an asynchronous model we will have to create a parallel thread that manages the request. HTTP redirections are resolved automatically.

http_post

Make a POST request.

```
bool_t
http_post(Http *http,
          const char_t *path,
          const byte_t *data,
          const uint32_t size,
          ierror_t *error);
```

http HTTP session.

path Resource.

data Data to add in the body of the request. It can be `NULL`.

size Data block size in bytes.

error Error code if the function fails. It can be `NULL`.

Return:

`TRUE` if the request has been processed correctly. If `FALSE`, in error we will have the cause.

Remarks:

See `http_get`.

http_response_status

Returns the response code of an HTTP request.

```
uint32_t
http_response_status(const Http *http);
```

http HTTP session.

Return:

The response code from the server.

http_response_protocol

Returns the protocol used by the HTTP server.

```
const char_t*
http_response_protocol(const Http *http);
```

http HTTP session.

Return:

The server protocol.

http_response_message

Returns the response message from the HTTP server.

```
const char_t*
http_response_message(const Http *http);
```

http HTTP session.

Return:

The response message from the server.

http_response_size

Returns the number of response headers from an HTTP request.

```
uint32_t
http_response_size(const Http *http);
```

http HTTP session.

Return:

The number of headers.

http_response_name

Returns the name of the response header of an HTTP request.

```
const char_t*
http_response_name(const Http *http,
                  const uint32_t index);
```

http HTTP session.

index The index of the header (0, size-1).

Return:

The name of the header.

http_response_value

Returns the value of the response header of an HTTP request.

```
const char_t*
http_response_value(const Http *http,
                   const uint32_t index);
```

http HTTP session.

index The index of the header (0, size-1).

Return:

The value of the header.

http_response_header

Returns the value of a response header from an HTTP request.

```
const char_t*
http_response_header(const Http *http,
                    const char_t *name);
```

http HTTP session.

name The name of the desired header.

Return:

The value of the header. If the header does not exist, it will return an empty string "".

http_response_body

Returns the response body of an HTTP request.

```
bool_t
http_response_body(const Http *http,
                  Stream *body,
                  ierror_t *error);
```

http HTTP session.

body Write stream where the response content will be stored.

error Error code if the function fails. It can be `NULL`.

Return:

`TRUE` if it was read successfully. If `FALSE`, in error we will have the cause.

http_dget

Make a direct request for a web resource.

```
Stream*
http_dget(const char_t *url,
          uint32_t *result,
          ierror_t *error);
```

```
Stream *jjson = http_dget("http://serv.nappgui.com:80/dproducts.php", NULL, NULL
↔ );
if (jjson)
{
    ...
    stm_close(&jjson);
}
```

url Resource URL.

result Server response code. It can be `NULL`.

error Error code if the function fails. It can be `NULL`.

Return:

Stream with the result of the request.

Remarks:

Use this function for direct access to an isolated resource. If you need to make several requests or configure the headers, use `http_create` or `http_secure`.

http_exists

Check if a web resource is available / accessible.

```
bool_t
http_exists(const char_t *url);
```

url Resource URL.

Return:

`TRUE` if the resource (web page, file, etc) is accessible.

Remarks:

HTTP redirections are not resolved. It will return `FALSE` if the URL as is is not valid.

json_read

Parse a JSON script. It will transform JSON text into a type or object in C.

```

type*
json_read(Stream *stm,
          const JsonOpts *opts,
          type);

```

stm Data entry in JSON format.

opts Options.

type Type of data.

Return:

Result object.

Remarks:

See “JSON parsing and conversion to data in C” (page 405).

json_write

Write data in C to JSON format.

```

void
json_write(Stream *stm,
           type *data,
           const JsonOpts *opts,
           type);

```

stm Data output in JSON format.

data Object.

opts Options.

type Type of data.

Remarks:

See “Convert from C to JSON” (page 409).

json_destroy

Destroys a JSON object, previously created with `json_read`.

```

void
json_destroy(type **data,
            type);

```

data Object.
 type Type of data.

json_destopt

Destroys a JSON object, previously created with `json_read`, if it is not `NULL`.

```
void
json_destopt(type **data,
             type);
```

data Object.
 type Type of data.

url_parse

Create a URL object from a text string.

```
Url*
url_parse(const char_t *url);
```

url Null-terminated UTF8 C text string '\0'.

Return:

Result URL object after parsing the string.

url_destroy

Destroy the URL object.

```
void
url_destroy(Url **url);
```

url URL object. Will be set to `NULL` after destruction.

url_scheme

Gets the scheme (protocol) of the URL.

```
const char_t*
url_scheme(const Url *url);
```

url URL object.

Return:

Protocol (http, https, ftp, etc).

url_user

Gets the user.

```
const char_t*  
url_user(const Url *url);
```

url URL object.

Return:

User or "" if not specified.

url_pass

Get the password.

```
const char_t*  
url_pass(const Url *url);
```

url URL object.

Return:

Password or "" if not specified.

url_host

Gets the name of the server.

```
const char_t*  
url_host(const Url *url);
```

url URL object.

Return:

Host (Pe. www.google.com).

url_path

Gets the path (directories + name) of the requested file or resource.

```
const char_t*  
url_path(const Url *url);
```

url URL object.

Return:

Pathname (Pe. /dir1/dir2/file.html).

url_params

Gets the parameters (from ';') of the URL.

```
const char_t*
url_params(const Url *url);
```

url URL object.

Return:

Parameters or "" if not specified.

url_query

Gets the parameters (from '?') of the URL.

```
const char_t*
url_query(const Url *url);
```

url URL object.

Return:

Parameters or "" if not specified.

url_fragment

Gets the fragment (position or anchor of the document) of the URL.

```
const char_t*
url_fragment(const Url *url);
```

url URL object.

Return:

Fragment or "" if not specified.

url_resource

Get the full address of a resource within the server.

```
String*
url_resource(const Url *url);
```

url URL object.

Return:

Resource. path + ";" + params + "?" + query + "#" + fragment.

url_port

Gets the access port to the server.

```
uint16_t
url_port(const Url *url);
```

url URL object.

Return:

Port. `UINT16_MAX` if not specified.

b64_encoded_size

Get the number of bytes needed to encode a memory block in format **base64**.

```
uint32_t
b64_encoded_size(const uint32_t data_size);
```

data_size The original block size.

Return:

Base64 size.

b64_decoded_size

Get the number of bytes needed to decode a block of memory in **base64** format.

```
uint32_t
b64_decoded_size(const uint32_t data_size);
```

data_size The block size encoded in base64.

Return:

The size in bytes.

b64_encode

Encode a block of memory in **base64**.

```
uint32_t
b64_encode(const byte_t *data,
           const uint32_t size,
           char_t *base64);
```

data The data block.
size Block size.
base64 The buffer where to store the result.

Return:

The size in bytes.

Remarks:

The buffer `base64` must be at least the size returned by `b64_encoded_size`.

b64_decode

De-encode a block **base64**.

```
uint32_t  
b64_decode(const char_t *base64,  
           const uint32_t size,  
           byte_t *data);
```

base64 The base64 block.
size Block size.
data The buffer where to store the result.

Return:

The size in bytes.

Remarks:

The buffer `data` must be at least the size returned by `b64_decoded_size`.

OGL3D library

46.1. Types and Constants

enum oglapi_t

OpenGL version.

<code>ekOGL_1_1</code>	OpenGL 1.1.
<code>ekOGL_1_2</code>	OpenGL 1.2.
<code>ekOGL_1_2_1</code>	OpenGL 1.2.1.
<code>ekOGL_1_3</code>	OpenGL 1.3.
<code>ekOGL_1_4</code>	OpenGL 1.4.
<code>ekOGL_1_5</code>	OpenGL 1.5.
<code>ekOGL_2_0</code>	OpenGL 2.0.
<code>ekOGL_2_1</code>	OpenGL 2.1.
<code>ekOGL_3_0</code>	OpenGL 3.0.
<code>ekOGL_3_1</code>	OpenGL 3.1.
<code>ekOGL_3_2</code>	OpenGL 3.2.
<code>ekOGL_3_3</code>	OpenGL 3.3.
<code>ekOGL_4_0</code>	OpenGL 4.0.
<code>ekOGL_4_1</code>	OpenGL 4.1.
<code>ekOGL_4_2</code>	OpenGL 4.2.
<code>ekOGL_4_3</code>	OpenGL 4.3.

`ekOGL_4_4` OpenGL 4.4.

`ekOGL_4_5` OpenGL 4.5.

`ekOGL_4_6` OpenGL 4.6.

enum oglerr_t

Error codes in OpenGL.

`ekOGLAPIVERS` Unsupported version.

`ekOGLFULLSCN` Full screen mode not supported.

`ekOGLVIEW` Error binding context to view.

`ekOGLPIXFORMAT` Pixel format not supported.

`ekOGLCONTEXT` Error creating context.

`ekOGLGLEW` Error when initializing GLEW.

`ekOGLOK` No error.

struct OGLProps

Properties of the OpenGL context, necessary for its creation.

```

struct OGLProps
{
    oglapi_t api;
    bool_t hdaccel;
    uint32_t color_bpp;
    uint32_t depth_bpp;
    uint32_t stencil_bpp;
    uint32_t aux_buffers;
    bool_t transparent;
    OGLCtx* shared;
};

```

`api` Required API version.

`hdaccel` Hardware 3D acceleration required. Normally `TRUE`.

`color_bpp` Number of bits per pixel of the color buffer. Normally 32.

`depth_bpp` Number of bits per pixel of the depth buffer. 8, 16, 24, 32.
If 0, the buffer is disabled.

`stencil_bpp` Number of bits per pixel of the stencil buffer. 8, 16, 24, 32.
If 0, the buffer is disabled.

aux_buffers Number of auxiliary color buffers. Normally 0.
 transparent If **TRUE** an attempt is made to create a transparent context.
 shared Context with which to share graphic objects. Normally **NULL**

struct OGLCtx

OpenGL context.

```
struct OGLCtx;
```

46.2. Functions

ogl3d_start

Start the OGL3D library.

```
void  
ogl3d_start(void);
```

Remarks:

Call this function before any other in OGL3D.

ogl3d_finish

Finalize the OGL3D library.

```
void  
ogl3d_finish(void);
```

Remarks:

Call this function before closing the program or when you no longer need to use OGL3D.

ogl3d_context

Creates an OpenGL context and associates it with a view.

```
OGLCtx*  
ogl3d_context(const OGLProps *props,  
             void *view,  
             oglerr_t *err);
```

- props Desired properties for the context.
- view Native view handler.HWND in Windows, GtkWidget in Linux or NSView in macOS.
- err Error code. It can be `NULL`.

Return:

Newly created context or `NULL` if there has been an error.

Remarks:

See “3D Contexts” (page 416).

ogl3d_destroy

Destroys an OpenGL context.

```
void
ogl3d_destroy(OGLCtx **ogl);
```

ogl Context to destroy. The pointer will be set to `NULL`.

ogl3d_begin_draw

Starts a drawing operation with OpenGL.

```
void
ogl3d_begin_draw(OGLCtx *ogl);
```

ogl Context.

Remarks:

See “Drawing operation” (page 417).

ogl3d_end_draw

Completes an OpenGL drawing operation.

```
void
ogl3d_end_draw(OGLCtx *ogl);
```

ogl Context.

Remarks:

See “Drawing operation” (page 417).

ogl3d_set_size

Updates the context size in pixels. This function must be called every time the view is resized.

```
void  
ogl3d_set_size(OGLCtx *ogl,  
               const uint32_t width,  
               const uint32_t height);
```

ogl Context.

width Width of the view in pixels.

height Height of the view in pixels.

ogl3d_err_str

Returns an explanatory text, associated with an error code.

```
const char_t*  
ogl3d_err_str(const oglerr_t err);
```

err Error code.

Return:

Text string with the error.

Index

align_t, 1116
ArrPt, 897
arrpt_all, 987
arrpt_all_const, 988
arrpt_append, 989
arrpt_bsearch, 994
arrpt_bsearch_const, 995
arrpt_clear, 984
arrpt_copy, 983
arrpt_create, 982
arrpt_delete, 991
arrpt_destopt, 984
arrpt_destroy, 984
arrpt_end, 997
arrpt_find, 992
arrpt_first, 986
arrpt_first_const, 986
arrpt_forback, 996
arrpt_forback_const, 996
arrpt_foreach, 995
arrpt_foreach_const, 995
arrpt_get, 985
arrpt_get_const, 986
arrpt_grow, 988
arrpt_insert, 989
arrpt_insert_n, 990
arrpt_join, 990
arrpt_last, 987
arrpt_last_const, 987
arrpt_pop, 991
arrpt_prepend, 989
arrpt_read, 983
arrpt_search, 993
arrpt_search_const, 993
arrpt_size, 985
arrpt_sort, 991
arrpt_sort_ex, 992
arrpt_write, 985
ArrSt, 897
arrst_all, 971
arrst_all_const, 972
arrst_append, 975
arrst_bsearch, 979
arrst_bsearch_const, 980
arrst_clear, 968
arrst_copy, 967
arrst_create, 966
arrst_delete, 977
arrst_destopt, 968
arrst_destroy, 967
arrst_end, 982
arrst_first, 970
arrst_first_const, 970
arrst_forback, 982
arrst_forback_const, 982
arrst_foreach, 981
arrst_foreach_const, 981
arrst_get, 969
arrst_get_const, 970
arrst_grow, 972
arrst_insert, 976
arrst_insert_n, 975
arrst_join, 976
arrst_last, 971
arrst_last_const, 971
arrst_new, 972
arrst_new0, 973
arrst_new_n, 973
arrst_new_n0, 974
arrst_pop, 977
arrst_prepend, 975
arrst_prepend_n, 974
arrst_read, 967
arrst_search, 978
arrst_search_const, 979
arrst_size, 969

arrst_sort, 978
 arrst_sort_ex, 978
 arrst_write, 968

 b64_decode, 1343
 b64_decoded_size, 1342
 b64_encode, 1342
 b64_encoded_size, 1342
 bfile_close, 875
 bfile_create, 874
 bfile_delete, 878
 bfile_dir_close, 873
 bfile_dir_create, 872
 bfile_dir_data, 871
 bfile_dir_delete, 874
 bfile_dir_exec, 871
 bfile_dir_get, 873
 bfile_dir_home, 871
 bfile_dir_open, 872
 bfile_dir_set_work, 870
 bfile_dir_work, 870
 bfile_fstat, 875
 bfile_lstat, 875
 bfile_open, 874
 bfile_pos, 878
 bfile_read, 876
 bfile_seek, 877
 bfile_write, 876
 blib_abort, 837
 blib_atexit, 837
 blib_bsearch, 835
 blib_bsearch_ex, 836
 blib_debug_break, 838
 blib_exit, 838
 blib_getenv, 836
 blib_qsort, 834
 blib_qsort_ex, 835
 blib_setenv, 837
 blib_strcat, 831
 blib_strcmp, 831
 blib_strcpy, 830
 blib_strftime, 832
 blib_strlen, 829
 blib_strncmp, 831
 blib_strncpy, 830
 blib_strstr, 830
 blib_strtod, 834
 blib_strtof, 834
 blib_strtol, 833
 blib_strtoul, 833
 BMath::abs, 822
 BMath::acos, 818
 BMath::asin, 818
 BMath::atan2, 819
 BMath::ceil, 826
 BMath::clamp, 823
 BMath::cos, 817
 BMath::exp, 821
 BMath::floor, 826
 BMath::isqrt, 820
 BMath::log, 820
 BMath::log10, 821
 BMath::max, 822
 BMath::min, 823
 BMath::mod, 824
 BMath::modf, 824
 BMath::norm_angle, 819
 BMath::pow, 821
 BMath::prec, 825
 BMath::rand, 827
 BMath::rand_mt, 828
 BMath::round, 825
 BMath::round_step, 825
 BMath::sin, 817
 BMath::sqrt, 820
 BMath::tan, 817
 bmath_absd, 822
 bmath_absf, 822
 bmath_acosd, 818
 bmath_acosf, 818
 bmath_asind, 818
 bmath_asinf, 818
 bmath_atan2d, 819
 bmath_atan2f, 819

bmath_ceil, 826
 bmath_ceilf, 826
 bmath_clampd, 823
 bmath_clampf, 823
 bmath_cosd, 817
 bmath_cosf, 817
 bmath_expd, 821
 bmath_expf, 821
 bmath_floord, 826
 bmath_floorf, 826
 bmath_isqrtd, 820
 bmath_isqrtf, 820
 bmath_log10d, 821
 bmath_log10f, 821
 bmath_logd, 820
 bmath_logf, 820
 bmath_maxd, 822
 bmath_maxf, 822
 bmath_mind, 823
 bmath_minf, 823
 bmath_modd, 824
 bmath_modf, 824
 bmath_modfd, 824
 bmath_modff, 824
 bmath_norm_angled, 819
 bmath_norm_anglef, 819
 bmath_powd, 821
 bmath_powf, 821
 bmath_precd, 825
 bmath_precf, 825
 bmath_rand_destroy, 828
 bmath_rand_env, 828
 bmath_rand_mtd, 828
 bmath_rand_mtf, 828
 bmath_rand_mti, 829
 bmath_rand_seed, 827
 bmath_randd, 827
 bmath_randf, 827
 bmath_randi, 828
 bmath_round_stepd, 825
 bmath_round_stepf, 825
 bmath_rounddd, 825
 bmath_roundf, 825
 bmath_sind, 817
 bmath_sinf, 817
 bmath_sqrted, 820
 bmath_sqrtf, 820
 bmath_tand, 817
 bmath_tanf, 817
 bmem_aligned_malloc, 843
 bmem_aligned_realloc, 843
 bmem_cmp, 846
 bmem_copy, 847
 bmem_copy_n, 848
 bmem_free, 843
 bmem_is_zero, 846
 bmem_malloc, 842
 bmem_move, 848
 bmem_overlaps, 849
 bmem_realloc, 842
 bmem_rev, 849
 bmem_rev2, 849
 bmem_rev4, 849
 bmem_rev8, 850
 bmem_rev_elems, 850
 bmem_revcopy, 850
 bmem_set1, 844
 bmem_set16, 845
 bmem_set4, 844
 bmem_set8, 844
 bmem_set_r32, 845
 bmem_set_u32, 845
 bmem_set_zero, 846
 bmem_shuffle, 851
 bmem_shuffle_n, 851
 bmem_swap, 850
 bmem_swap_type, 851
 bmem_zero, 847
 bmem_zero_n, 847
 bmutex_close, 867
 bmutex_create, 867
 bmutex_lock, 867
 bmutex_unlock, 868
 bool_t, 794

Box2D, 1045, 1075
 Box2D::add, 1076
 Box2D::add_circle, 1077
 Box2D::addn, 1077
 Box2D::area, 1078
 Box2D::center, 1076
 Box2D::from_points, 1075
 Box2D::is_null, 1079
 Box2D::merge, 1078
 Box2D::segments, 1078
 box2d_add_circled, 1077
 box2d_add_circlef, 1077
 box2d_addd, 1076
 box2d_addf, 1076
 box2d_addnd, 1077
 box2d_addnf, 1077
 box2d_aread, 1078
 box2d_areaf, 1078
 box2d_centerd, 1076
 box2d_centerf, 1076
 box2d_from_pointsd, 1075
 box2d_from_pointsf, 1075
 box2d_is_nulld, 1079
 box2d_is_nullf, 1079
 box2d_merged, 1078
 box2d_mergef, 1078
 box2d_segmentsd, 1078
 box2d_segmentsf, 1078
 box2dd, 1075
 box2df, 1075
 bproc_cancel, 860
 bproc_close, 860
 bproc_eread, 862
 bproc_eread_close, 864
 bproc_exec, 860
 bproc_exit, 864
 bproc_finish, 861
 bproc_read, 861
 bproc_read_close, 863
 bproc_wait, 861
 bproc_write, 863
 bproc_write_close, 864
 bsocket_accept, 879
 bsocket_close, 880
 bsocket_connect, 878
 bsocket_host_name, 883
 bsocket_host_name_ip, 883
 bsocket_hton2, 884
 bsocket_hton4, 885
 bsocket_hton8, 885
 bsocket_ip_str, 884
 bsocket_local_ip, 880
 bsocket_ntoh2, 885
 bsocket_ntoh4, 885
 bsocket_ntoh8, 886
 bsocket_read, 881
 bsocket_read_timeout, 881
 bsocket_remote_ip, 880
 bsocket_server, 879
 bsocket_str_ip, 883
 bsocket_url_ip, 882
 bsocket_write, 882
 bsocket_write_timeout, 881
 bstd_eprintf, 839
 bstd_ewrite, 841
 bstd_ewritef, 840
 bstd_printf, 839
 bstd_read, 840
 bstd_sprintf, 838
 bstd_vsprintf, 839
 bstd_write, 841
 bstd_writeln, 840
 bthread_cancel, 866
 bthread_close, 865
 bthread_create, 865
 bthread_current_id, 865
 bthread_finish, 866
 bthread_sleep, 867
 bthread_wait, 866
 btime_date, 886
 btime_now, 886
 btime_to_date, 887
 btime_to_micro, 887
 Buffer, 896

buffer_const, 911
 buffer_create, 909
 buffer_data, 910
 buffer_destroy, 910
 buffer_size, 910
 buffer_with_data, 910
 Button, 1179
 button_check, 1206
 button_check3, 1206
 button_flat, 1206
 button_flatgle, 1206
 button_font, 1208
 button_get_height, 1211
 button_get_state, 1210
 button_get_tag, 1210
 button_image, 1208
 button_image_alt, 1209
 button_OnClick, 1207
 button_push, 1205
 button_radio, 1206
 button_state, 1209
 button_tag, 1209
 button_text, 1207
 button_text_alt, 1208
 button_tooltip, 1208
 button_vpadding, 1210
 byte_t, 794

 cassert, 800
 cassert_default, 802
 cassert_fatal, 801
 cassert_fatal_msg, 801
 cassert_msg, 801
 cassert_no_null, 802
 cassert_no_nullf, 802
 cassert_set_func, 802
 Cell, 1181
 cell_button, 1298
 cell_combo, 1298
 cell_control, 1297
 cell_dbind, 1303
 cell_edit, 1298
 cell_empty, 1297
 cell_enabled, 1302
 cell_imageview, 1300
 cell_label, 1297
 cell_layout, 1301
 cell_listbox, 1299
 cell_padding, 1302
 cell_padding2, 1302
 cell_padding4, 1303
 cell_panel, 1301
 cell_popup, 1298
 cell_progress, 1299
 cell_slider, 1299
 cell_splitview, 1301
 cell_tableview, 1301
 cell_textview, 1300
 cell_updown, 1299
 cell_view, 1300
 cell_visible, 1302
 cell_webview, 1300
 char_t, 794
 Cir2D, 1045, 1072
 Cir2D::area, 1074
 Cir2D::from_box, 1072
 Cir2D::from_points, 1073
 Cir2D::is_null, 1074
 Cir2D::minimum, 1073
 cir2d_aread, 1074
 cir2d_areaf, 1074
 cir2d_from_boxd, 1072
 cir2d_from_boxf, 1072
 cir2d_from_pointsd, 1073
 cir2d_from_pointsf, 1073
 cir2d_is_nulld, 1074
 cir2d_is_nullf, 1074
 cir2d_minimumd, 1073
 cir2d_minimumf, 1073
 cir2dd, 1072
 cir2df, 1072
 Clock, 899
 clock_create, 1039
 clock_destroy, 1039

clock_elapsed, 1040
 clock_frame, 1040
 clock_reset, 1040
 codec_t, 1115
 Col2D, 1047
 Col2D::box_box, 1101
 Col2D::box_circle, 1101
 Col2D::box_point, 1099
 Col2D::box_segment, 1100
 Col2D::circle_circle, 1099
 Col2D::circle_point, 1098
 Col2D::circle_segment, 1098
 Col2D::obb_box, 1104
 Col2D::obb_circle, 1103
 Col2D::obb_obb, 1104
 Col2D::obb_point, 1102
 Col2D::obb_segment, 1102
 Col2D::point_point, 1096
 Col2D::poly_box, 1110
 Col2D::poly_circle, 1110
 Col2D::poly_obb, 1111
 Col2D::poly_point, 1108
 Col2D::poly_poly, 1112
 Col2D::poly_segment, 1109
 Col2D::poly_tri, 1111
 Col2D::segment_point, 1096
 Col2D::segment_segment, 1097
 Col2D::tri_box, 1107
 Col2D::tri_circle, 1106
 Col2D::tri_obb, 1107
 Col2D::tri_point, 1105
 Col2D::tri_segment, 1105
 Col2D::tri_tri, 1108
 col2d_box_boxd, 1101
 col2d_box_boxf, 1101
 col2d_box_circled, 1101
 col2d_box_circlef, 1101
 col2d_box_pointd, 1099
 col2d_box_pointf, 1099
 col2d_box_segmentd, 1100
 col2d_box_segmentf, 1100
 col2d_circle_circled, 1099
 col2d_circle_pointd, 1098
 col2d_circle_pointf, 1098
 col2d_circle_segmentd, 1098
 col2d_circle_segmentf, 1098
 col2d_obb_boxd, 1104
 col2d_obb_boxf, 1104
 col2d_obb_circled, 1103
 col2d_obb_circlef, 1103
 col2d_obb_obbd, 1104
 col2d_obb_obbf, 1104
 col2d_obb_pointd, 1102
 col2d_obb_pointf, 1102
 col2d_obb_segmentd, 1102
 col2d_obb_segmentf, 1102
 col2d_point_pointd, 1096
 col2d_point_pointf, 1096
 col2d_poly_boxd, 1110
 col2d_poly_boxf, 1110
 col2d_poly_circled, 1110
 col2d_poly_circlef, 1110
 col2d_poly_obbd, 1111
 col2d_poly_obbf, 1111
 col2d_poly_pointd, 1108
 col2d_poly_pointf, 1108
 col2d_poly_polyd, 1112
 col2d_poly_polyf, 1112
 col2d_poly_segmentd, 1109
 col2d_poly_segmentf, 1109
 col2d_poly_trid, 1111
 col2d_poly_trif, 1111
 col2d_segment_pointd, 1096
 col2d_segment_pointf, 1096
 col2d_segment_segmentd, 1097
 col2d_segment_segmentf, 1097
 col2d_tri_boxd, 1107
 col2d_tri_boxf, 1107
 col2d_tri_circled, 1106
 col2d_tri_circlef, 1106
 col2d_tri_obbd, 1107
 col2d_tri_obbf, 1107
 col2d_tri_pointd, 1105

col2d_tri_pointf, 1105
 col2d_tri_segmentd, 1105
 col2d_tri_segmentf, 1105
 col2d_tri_trid, 1108
 col2d_tri_trif, 1108
 color_bgr, 1140
 color_blue, 1139
 color_get_alpha, 1143
 color_get_rgb, 1142
 color_get_rgba, 1142
 color_get_rgbaf, 1143
 color_get_rgbf, 1142
 color_gray, 1140
 color_green, 1139
 color_hsb, 1138
 color_html, 1141
 color_red, 1139
 color_rgb, 1137
 color_rgba, 1137
 color_rgbaf, 1138
 color_set_alpha, 1144
 color_t, 1117
 color_to_hsb, 1141
 color_to_html, 1141
 Combo, 1179
 combo_add_elem, 1226
 combo_align, 1223
 combo_bgcolor, 1224
 combo_bgcolor_focus, 1224
 combo_color, 1223
 combo_color_focus, 1223
 combo_count, 1225
 combo_create, 1221
 combo_del_elem, 1227
 combo_duplicates, 1227
 combo_get_text, 1225
 combo_ins_elem, 1226
 combo_OnChange, 1222
 combo_OnFilter, 1222
 combo_phcolor, 1224
 combo_phstyle, 1225
 combo_phtext, 1224
 combo_set_elem, 1226
 combo_text, 1222
 combo_tooltip, 1223
 comwin_color, 1323
 comwin_open_file, 1322
 comwin_save_file, 1322
 core_event_t, 890
 core_finish, 901
 core_start, 901

 Date, 857
 date_add_days, 1036
 date_add_hours, 1036
 date_add_minutes, 1036
 date_add_seconds, 1035
 date_between, 1038
 date_cmp, 1037
 date_ellapsed_seconds, 1037
 date_format, 1039
 date_is_null, 1038
 date_is_valid, 1038
 date_pack, 1035
 date_system, 1035
 date_weekday, 1038
 date_year, 1037
 dbind, 1015
 dbind_create, 1016
 dbind_default, 1018
 dbind_destopt, 1017
 dbind_destroy, 1017
 dbind_enum, 1016
 dbind_increment, 1019
 dbind_init, 1016
 dbind_precision, 1019
 dbind_range, 1018
 dbind_read, 1017
 dbind_remove, 1017
 dbind_suffix, 1020
 dbind_write, 1018
 DCtx, 1117
 dctx_bitmap, 1119
 dctx_image, 1119

DeclPt, 889
 DeclSt, 889
 device_t, 853
 Dir, 857
 DirEntry, 898
 DLib, 858
 dlib_close, 869
 dlib_open, 868
 dlib_proc, 869
 dlib_var, 869
 Draw, 1117
 draw2d_finish, 1118
 draw2d_start, 1118
 Draw::box2d, 1135
 Draw::cir2d, 1134
 Draw::matrix, 1120
 Draw::matrix_cartesian, 1120
 Draw::obb2d, 1135
 Draw::pol2d, 1136
 Draw::seg2d, 1134
 Draw::tri2d, 1136
 Draw::v2d, 1133
 draw_antialias, 1121
 draw_arc, 1122
 draw_bezier, 1122
 draw_box2dd, 1135
 draw_box2df, 1135
 draw_cir2dd, 1134
 draw_cir2df, 1134
 draw_circle, 1126
 draw_clear, 1119
 draw_ellipse, 1126
 draw_fill_color, 1127
 draw_fill_linear, 1127
 draw_fill_matrix, 1128
 draw_fill_wrap, 1128
 draw_font, 1129
 draw_image, 1132
 draw_image_align, 1133
 draw_image_frame, 1132
 draw_line, 1121
 draw_line_cap, 1124
 draw_line_color, 1123
 draw_line_dash, 1124
 draw_line_fill, 1123
 draw_line_join, 1124
 draw_line_width, 1123
 draw_matrix_cartesiand, 1120
 draw_matrix_cartesianf, 1120
 draw_matrixd, 1120
 draw_matrixf, 1120
 draw_obb2dd, 1135
 draw_obb2df, 1135
 draw_pol2dd, 1136
 draw_pol2df, 1136
 draw_polygon, 1126
 draw_polyline, 1121
 draw_rect, 1125
 draw_rndrect, 1125
 draw_seg2dd, 1134
 draw_seg2df, 1134
 draw_text, 1129
 draw_text_align, 1131
 draw_text_color, 1129
 draw_text_extents, 1131
 draw_text_halign, 1131
 draw_text_path, 1130
 draw_text_trim, 1130
 draw_text_width, 1130
 draw_tri2dd, 1136
 draw_tri2df, 1136
 draw_v2dd, 1133
 draw_v2df, 1133
 drawop_t, 1116

 Edit, 1179
 edit_align, 1216
 edit_autoselect, 1217
 edit_bgcolor, 1218
 edit_bgcolor_focus, 1219
 edit_color, 1218
 edit_color_focus, 1218
 edit_copy, 1221
 edit_create, 1214

edit_cut, 1221
edit_editable, 1217
edit_font, 1216
edit_get_height, 1220
edit_get_text, 1220
edit_multiline, 1214
edit_OnChange, 1215
edit_OnFilter, 1215
edit_OnFocus, 1215
edit_passmode, 1216
edit_paste, 1221
edit_phcolor, 1219
edit_phstyle, 1220
edit_phtext, 1219
edit_select, 1217
edit_text, 1216
edit_tooltip, 1218
edit_vpadding, 1220
ekAPPEND, 855
ekAPRIL, 855
ekARCHIVE, 855
ekAUGUST, 855
ekBIGEND, 854
ekBMP, 1115
ekBOTTOM, 1116
ekCENTER, 1116
ekDECEMBER, 855
ekDESKTOP, 853
ekDIRECTORY, 855
ekEASSERT, 890
ekEENTRY, 890
ekEEXIT, 890
ekEFILE, 890
ekELLIPBEGIN, 1117
ekELLIPEND, 1117
ekELLIPMIDDLE, 1117
ekELLIPMLINE, 1117
ekELLIPNONE, 1117
ekFBIG, 856
ekFBIGNAME, 856
ekFBOLD, 1115
ekFCLAMP, 1116
ekFEBRUARY, 855
ekFEXISTS, 856
ekFFLIP, 1116
ekFILL, 1116
ekFILLSK, 1116
ekFIMAGE, 1115
ekFITALIC, 1115
ekFLOCK, 856
ekFNOACCESS, 856
ekFNOEMPTY, 856
ekFNOFILE, 856
ekFNOFILES, 856
ekFNOPATH, 856
ekFNORMAL, 1115
ekFOK, 856
ekFPIXELS, 1115
ekFPOINTS, 1115
ekFRIDAY, 854
ekFSEEKNEG, 856
ekFSTRIKEOUT, 1115
ekFSUBSCRIPT, 1115
ekFSUPSCRIPT, 1115
ekFTILE, 1116
ekFUNDEF, 856
ekFUNDERLINE, 1115
ekGIF, 1115
ekGRAY8, 1114
ekGUI_CLOSE_BUTTON, 1174
ekGUI_CLOSE_DEACT, 1174
ekGUI_CLOSE_ESC, 1174
ekGUI_CLOSE_INTRO, 1174
ekGUI_CURSOR_ARROW, 1174
ekGUI_CURSOR_CROSS, 1174
ekGUI_CURSOR_HAND, 1174
ekGUI_CURSOR_IBEAM, 1174
ekGUI_CURSOR_SIZENS, 1174
ekGUI_CURSOR_SIZEWE, 1174
ekGUI_CURSOR_USER, 1174
ekGUI_EVENT_BUTTON, 1175
ekGUI_EVENT_CLICK, 1176
ekGUI_EVENT_COLOR, 1176
ekGUI_EVENT_DOWN, 1176

ekGUI_EVENT_DRAG, 1176
 ekGUI_EVENT_DRAW, 1176
 ekGUI_EVENT_ENTER, 1176
 ekGUI_EVENT_EXIT, 1176
 ekGUI_EVENT_FOCUS, 1176
 ekGUI_EVENT_FOCUS_ACCEPT, 1176
 ekGUI_EVENT_FOCUS_RESIGN, 1176
 ekGUI_EVENT_KEYDOWN, 1176
 ekGUI_EVENT_KEYUP, 1176
 ekGUI_EVENT_LABEL, 1175
 ekGUI_EVENT_LISTBOX, 1175
 ekGUI_EVENT_MENU, 1176
 ekGUI_EVENT_MOVED, 1176
 ekGUI_EVENT_OBJCHANGE, 1177
 ekGUI_EVENT_OVERLAY, 1176
 ekGUI_EVENT_POPUP, 1175
 ekGUI_EVENT_RESIZE, 1176
 ekGUI_EVENT_SCROLL, 1176
 ekGUI_EVENT_SLIDER, 1176
 ekGUI_EVENT_TBL_BEGIN, 1177
 ekGUI_EVENT_TBL_CELL, 1177
 ekGUI_EVENT_TBL_END, 1177
 ekGUI_EVENT_TBL_HEADCLICK, 1177
 ekGUI_EVENT_TBL_NROWS, 1177
 ekGUI_EVENT_TBL_ROWCLICK, 1177
 ekGUI_EVENT_TBL_SEL, 1177
 ekGUI_EVENT_THEME, 1176
 ekGUI_EVENT_TXTCHANGE, 1176
 ekGUI_EVENT_TXTFILTER, 1176
 ekGUI_EVENT_UP, 1176
 ekGUI_EVENT_UPDOWN, 1176
 ekGUI_EVENT_WHEEL, 1176
 ekGUI_EVENT_WND_CLOSE, 1176
 ekGUI_EVENT_WND_MOVED, 1176
 ekGUI_EVENT_WND_SIZE, 1176
 ekGUI_EVENT_WND_SIZING, 1176
 ekGUI_FOCUS_CHANGED, 1175
 ekGUI_FOCUS_KEEP, 1175
 ekGUI_FOCUS_NO_ACCEPT, 1175
 ekGUI_FOCUS_NO_NEXT, 1175
 ekGUI_FOCUS_NO_RESIGN, 1175
 ekGUI_HORIZONTAL, 1173
 ekGUI_MIXED, 1173
 ekGUI_MOUSE_LEFT, 1173
 ekGUI_MOUSE_MIDDLE, 1173
 ekGUI_MOUSE_RIGHT, 1173
 ekGUI_NOTIF_LANGUAGE, 1179
 ekGUI_NOTIF_MENU_DESTROY, 1179
 ekGUI_NOTIF_WIN_DESTROY, 1179
 ekGUI_OFF, 1173
 ekGUI_ON, 1173
 ekGUI_SCALE_ASPECT, 1174
 ekGUI_SCALE_ASPECTDW, 1174
 ekGUI_SCALE_AUTO, 1174
 ekGUI_SCALE_NONE, 1174
 ekGUI_SCROLL_BEGIN, 1174
 ekGUI_SCROLL_END, 1174
 ekGUI_SCROLL_PAGE_LEFT, 1175
 ekGUI_SCROLL_PAGE_RIGHT, 1175
 ekGUI_SCROLL_STEP_LEFT, 1175
 ekGUI_SCROLL_STEP_RIGHT, 1175
 ekGUI_SCROLL_THUMB, 1175
 ekGUI_TAB_BACKKEY, 1175
 ekGUI_TAB_CLICK, 1175
 ekGUI_TAB_KEY, 1175
 ekGUI_TAB_MOVE, 1175
 ekGUI_TAB_NEXT, 1175
 ekGUI_TAB_PREV, 1175
 ekGUI_VERTICAL, 1173
 ekINDEX1, 1114
 ekINDEX2, 1114
 ekINDEX4, 1114
 ekINDEX8, 1114
 ekINOHOST, 1331
 ekINOIMPL, 1331
 ekINONET, 1331
 ekIOK, 1331
 ekIOS, 853
 ekISERVER, 1331
 ekISTREAM, 1331
 ekITIMEOUT, 1331
 ekIUNDEF, 1331
 ekJANUARY, 855
 ekJPG, 1115

ekJULY, 855
ekJUNE, 855
ekJUSTIFY, 1116
ekKEY_0, 891
ekKEY_1, 891
ekKEY_2, 891
ekKEY_3, 891
ekKEY_4, 891
ekKEY_5, 891
ekKEY_6, 891
ekKEY_7, 891
ekKEY_8, 891
ekKEY_9, 891
ekKEY_A, 890
ekKEY_B, 891
ekKEY_BACK, 892
ekKEY_BSLASH, 891
ekKEY_C, 891
ekKEY_CAPS, 894
ekKEY_COMMA, 892
ekKEY_D, 891
ekKEY_DOWN, 894
ekKEY_E, 891
ekKEY_END, 894
ekKEY_ESCAPE, 892
ekKEY_EXCLAM, 894
ekKEY_F, 891
ekKEY_F1, 894
ekKEY_F10, 893
ekKEY_F11, 893
ekKEY_F12, 893
ekKEY_F13, 893
ekKEY_F14, 893
ekKEY_F15, 893
ekKEY_F16, 893
ekKEY_F17, 892
ekKEY_F18, 893
ekKEY_F19, 893
ekKEY_F2, 894
ekKEY_F3, 893
ekKEY_F4, 894
ekKEY_F5, 893
ekKEY_F6, 893
ekKEY_F7, 893
ekKEY_F8, 893
ekKEY_F9, 893
ekKEY_G, 891
ekKEY_GRAVE, 894
ekKEY_GTTL, 892
ekKEY_H, 891
ekKEY_HOME, 893
ekKEY_I, 892
ekKEY_INSERT, 894
ekKEY_J, 892
ekKEY_K, 892
ekKEY_L, 892
ekKEY_LALT, 894
ekKEY_LCTRL, 894
ekKEY_LCURLY, 892
ekKEY_LEFT, 894
ekKEY_LSHIFT, 894
ekKEY_LWIN, 894
ekKEY_M, 892
ekKEY_MENU, 894
ekKEY_MINUS, 892
ekKEY_N, 892
ekKEY_NUM0, 893
ekKEY_NUM1, 893
ekKEY_NUM2, 893
ekKEY_NUM3, 893
ekKEY_NUM4, 893
ekKEY_NUM5, 893
ekKEY_NUM6, 893
ekKEY_NUM7, 893
ekKEY_NUM8, 893
ekKEY_NUM9, 893
ekKEY_NUMADD, 892
ekKEY_NUMDECIMAL, 892
ekKEY_NUMDIV, 892
ekKEY_NUMEQUAL, 893
ekKEY_NUMLOCK, 892
ekKEY_NUMMINUS, 892
ekKEY_NUMMULT, 892
ekKEY_NUMRET, 892

ekKEY_O, 891
ekKEY_P, 892
ekKEY_PAGEDOWN, 894
ekKEY_PAGEUP, 893
ekKEY_PERIOD, 892
ekKEY_PLUS, 894
ekKEY_Q, 891
ekKEY_QUESTION, 892
ekKEY_R, 891
ekKEY_RALT, 894
ekKEY_RCTRL, 894
ekKEY_RCURLY, 891
ekKEY_RETURN, 892
ekKEY_RIGHT, 894
ekKEY_RSHIFT, 894
ekKEY_RWIN, 894
ekKEY_S, 890
ekKEY_SEMICOLON, 892
ekKEY_SPACE, 892
ekKEY_SUPR, 894
ekKEY_T, 891
ekKEY_TAB, 892
ekKEY_TILDE, 894
ekKEY_U, 892
ekKEY_UNDEF, 890
ekKEY_UP, 894
ekKEY_V, 891
ekKEY_W, 891
ekKEY_X, 891
ekKEY_Y, 891
ekKEY_Z, 891
ekLCFLAT, 1115
ekLCROUND, 1116
ekLCSQUARE, 1115
ekLEFT, 1116
ekLINUX, 853
ekLITEND, 854
ekLJBEVEL, 1116
ekLJMITER, 1116
ekLJROUND, 1116
ekMACOS, 853
ekMARCH, 855
ekMAY, 855
ekMKEY_ALT, 895
ekMKEY_COMMAND, 895
ekMKEY_CONTROL, 895
ekMKEY_NONE, 894
ekMKEY_SHIFT, 895
ekMONDAY, 854
ekNOVEMBER, 855
ekOCTOBER, 855
ekOGL_1_1, 1345
ekOGL_1_2, 1345
ekOGL_1_2_1, 1345
ekOGL_1_3, 1345
ekOGL_1_4, 1345
ekOGL_1_5, 1345
ekOGL_2_0, 1345
ekOGL_2_1, 1345
ekOGL_3_0, 1345
ekOGL_3_1, 1345
ekOGL_3_2, 1345
ekOGL_3_3, 1345
ekOGL_4_0, 1345
ekOGL_4_1, 1345
ekOGL_4_2, 1345
ekOGL_4_3, 1345
ekOGL_4_4, 1346
ekOGL_4_5, 1346
ekOGL_4_6, 1346
ekOGLAPIVERS, 1346
ekOGLCONTEXT, 1346
ekOGLFULLSCN, 1346
ekOGLGLEW, 1346
ekOGLOK, 1346
ekOGLPIXFORMAT, 1346
ekOGLVIEW, 1346
ekOTHERFILE, 855
ekPEXEC, 856
ekPHONE, 853
ekPNG, 1115
ekPOK, 856
ekPPIPE, 856
ekREAD, 855

ekRGB24, 1114
ekRGBA32, 1115
ekRIGHT, 1116
ekSATURDAY, 854
ekSEEKCUR, 855
ekSEEKEND, 856
ekSEEKSET, 855
ekSEPTEMBER, 855
ekSKFILL, 1116
ekSNOHOST, 857
ekSNONET, 857
ekSOK, 857
ekSSTREAM, 857
ekSTBROKEN, 890
ekSTCORRUPT, 890
ekSTEND, 890
ekSTIMEOUT, 857
ekSTOK, 890
ekSTROKE, 1116
ekSUNDAY, 854
ekSUNDEF, 857
ekTABLET, 853
ekTAMPER, 896
ekTAPOST, 896
ekTASTERK, 895
ekTAT, 896
ekTBSLASH, 896
ekTCIRCUM, 896
ekTCLOSBRAC, 895
ekTCLOSCURL, 895
ekTCLOSPAR, 895
ekTCOLON, 895
ekTCOMMA, 895
ekTCORRUP, 896
ekTDOLLAR, 895
ekTEOF, 896
ekTEOL, 895
ekTEQUALS, 895
ekTEXCLA, 896
ekTGREAT, 895
ekTHEX, 896
ekTHURSDAY, 854
ekTIDENT, 896
ekTINTEGER, 896
ekTLESS, 895
ekTMINUS, 895
ekTMLCOM, 895
ekTOCTAL, 896
ekTOP, 1116
ekTOPENBRAC, 895
ekTOPENCURL, 895
ekTOPENPAR, 895
ekTPERCEN, 895
ekTPERIOD, 895
ekTPLUS, 895
ekTPOUND, 896
ekTQUEST, 896
ekTQUOTE, 896
ekTREAL, 896
ekTRESERVED, 896
ekTSCOLON, 895
ekTSLASH, 896
ekTSLCOM, 895
ekTSPACE, 895
ekTSTRING, 896
ekTTILDE, 896
ekTUESDAY, 854
ekTUNDEF, 896
ekTVLINE, 896
ekUTF16, 798
ekUTF32, 798
ekUTF8, 798
ekWEDNESDAY, 854
ekWIN_10, 854
ekWIN_2K, 853
ekWIN_7, 854
ekWIN_71, 854
ekWIN_8, 854
ekWIN_81, 854
ekWIN_9x, 853
ekWIN_NO, 854
ekWIN_NT4, 853
ekWIN_VI, 854
ekWIN_VI1, 854

- ekWIN_VI2, 854
- ekWIN_XP, 853
- ekWIN_XP1, 854
- ekWIN_XP2, 854
- ekWIN_XP3, 854
- ekWINDOW_CLOSE, 1177
- ekWINDOW_EDGE, 1177
- ekWINDOW_ESC, 1177
- ekWINDOW_FLAG, 1177
- ekWINDOW_MAX, 1177
- ekWINDOW_MIN, 1177
- ekWINDOW_MODAL_NOHIDE, 1177
- ekWINDOW_RESIZE, 1177
- ekWINDOW_RETURN, 1177
- ekWINDOW_STD, 1177
- ekWINDOW_STDRES, 1177
- ekWINDOW_TITLE, 1177
- ekWINDOWS, 853
- ekWRITE, 855
- ellipsis_t, 1117
- endian_t, 854
- evbind_modify, 1196
- evbind_object, 1196
- EvButton, 1182
- EvDraw, 1183
- Event, 898
- event_params, 1023
- event_result, 1023
- event_sender, 1023
- event_type, 1022
- EvFileDir, 899
- EvKey, 1185
- EvMenu, 1187
- EvMouse, 1184
- EvPos, 1185
- EvScroll, 1187
- EvSize, 1185
- EvSlider, 1182
- EvTbCell, 1189
- EvTbPos, 1188
- EvTbRect, 1188
- EvTbRow, 1188
- EvTbSel, 1189
- EvText, 1183
- EvTextFilter, 1183
- EvWheel, 1184
- EvWinClose, 1187
- FALSE, 794
- ferror_t, 856
- File, 857
- file_mode_t, 855
- file_seek_t, 855
- file_type_t, 855
- fillwrap_t, 1116
- FocusInfo, 1189
- Font, 1118
- font_ascent, 1167
- font_copy, 1164
- font_create, 1163
- font_descent, 1168
- font_destroy, 1165
- font_equals, 1165
- font_exists_family, 1169
- font_extents, 1169
- font_family, 1166
- font_height, 1167
- font_installed_families, 1170
- font_installed_monospace, 1170
- font_is_monospace, 1168
- font_leading, 1168
- font_mini_size, 1166
- font_monospace, 1164
- font_native, 1170
- font_regular_size, 1165
- font_size, 1167
- font_small_size, 1166
- font_style, 1169
- font_system, 1163
- font_with_style, 1164
- FPtr_app_create, 1325
- FPtr_app_update, 1325
- FPtr_assert, 800
- FPtr_compare, 799

FPtr_compare_ex, 799
 FPtr_copy, 798
 FPtr_destroy, 798
 FPtr_event_handler, 900
 FPtr_read, 900
 FPtr_read_init, 900
 FPtr_remove, 900
 FPtr_scopy, 799
 FPtr_task_end, 1326
 FPtr_task_main, 1325
 FPtr_task_update, 1326
 FPtr_thread_main, 858
 FPtr_write, 901
 fstyle_t, 1115

 gui_alt_color, 1192
 gui_border_color, 1193
 gui_close_t, 1174
 gui_cursor_t, 1173
 gui_dark_mode, 1192
 gui_event_t, 1175
 gui_file, 1191
 gui_finish, 1190
 gui_focus_t, 1175
 gui_image, 1191
 gui_info_window, 1195
 gui_label_color, 1192
 gui_language, 1190
 gui_line_color, 1193
 gui_link_color, 1193
 gui_mouse_pos, 1194
 gui_mouse_t, 1173
 gui_notif_t, 1177
 gui_OnIdle, 1195
 gui_OnNotification, 1195
 gui_OnThemeChanged, 1194
 gui_orient_t, 1173
 gui_resolution, 1193
 gui_respack, 1190
 gui_scale_t, 1174
 gui_scroll_t, 1174
 gui_start, 1189

 gui_state_t, 1173
 gui_tab_t, 1175
 gui_text, 1190
 gui_update, 1194
 gui_update_transitions, 1194
 gui_view_color, 1192
 GuiControl, 1179
 guicontrol, 1197
 guicontrol_button, 1197
 guicontrol_combo, 1198
 guicontrol_edit, 1198
 guicontrol_get_tag, 1202
 guicontrol_imageview, 1200
 guicontrol_label, 1197
 guicontrol_listbox, 1198
 guicontrol_panel, 1201
 guicontrol_popup, 1198
 guicontrol_progress, 1199
 guicontrol_slider, 1199
 guicontrol_splitview, 1201
 guicontrol_tableview, 1201
 guicontrol_tag, 1201
 guicontrol_textview, 1200
 guicontrol_updown, 1199
 guicontrol_view, 1200
 guicontrol_webview, 1200

 heap_aligned_calloc, 905
 heap_aligned_malloc, 904
 heap_aligned_realloc, 905
 heap_auditor_add, 909
 heap_auditor_delete, 909
 heap_calloc, 903
 heap_delete, 908
 heap_delete_n, 909
 heap_end_mt, 901
 heap_free, 906
 heap_leaks, 902
 heap_malloc, 902
 heap_new, 906
 heap_new0, 906
 heap_new_n, 907

heap_new_n0, 907
heap_realloc, 903
heap_realloc_n, 908
heap_start_mt, 901
heap_stats, 902
heap_verbose, 902
hfile_appdata, 1033
hfile_buffer, 1030
hfile_copy, 1029
hfile_date, 1027
hfile_dir, 1026
hfile_dir_create, 1026
hfile_dir_destroy, 1026
hfile_dir_entry_remove, 1027
hfile_dir_list, 1027
hfile_dir_loop, 1032
hfile_dir_sync, 1028
hfile_exists, 1029
hfile_from_data, 1031
hfile_from_string, 1031
hfile_home_dir, 1034
hfile_is_uptodate, 1029
hfile_stream, 1030
hfile_string, 1030
Http, 1331
http_add_header, 1333
http_clear_headers, 1333
http_create, 1332
http_destroy, 1332
http_dget, 1337
http_exists, 1337
http_get, 1333
http_post, 1334
http_response_body, 1336
http_response_header, 1336
http_response_message, 1335
http_response_name, 1335
http_response_protocol, 1334
http_response_size, 1335
http_response_status, 1334
http_response_value, 1336
http_secure, 1332
ierror_t, 1331
IListener, 898
Image, 1118
image_codec, 1160
image_copy, 1156
image_data, 1162
image_destroy, 1159
image_format, 1159
image_frame_length, 1161
image_from_data, 1155
image_from_file, 1154
image_from_pixbuf, 1154
image_from_pixels, 1153
image_from_resource, 1155
image_get_codec, 1161
image_get_data, 1162
image_height, 1159
image_native, 1162
image_num_frames, 1161
image_pixels, 1160
image_read, 1158
image_rotate, 1157
image_scale, 1157
image_to_file, 1158
image_trim, 1156
image_width, 1159
image_write, 1158
ImageView, 1181
imageview_create, 1258
imageview_image, 1259
imageview_OnClick, 1259
imageview_OnOverDraw, 1259
imageview_scale, 1259
imageview_size, 1258
INT16_MAX, 795
INT16_MIN, 795
int16_t, 793
INT32_MAX, 795
INT32_MIN, 795
int32_t, 793
INT64_MAX, 796
INT64_MIN, 795

int64_t, 793
 INT8_MAX, 795
 INT8_MIN, 795
 int8_t, 793

 json_destopt, 1339
 json_destroy, 1338
 json_read, 1338
 json_write, 1338
 JsonOpts, 1332

 kBMATH_DEG2RADd, 797
 kBMATH_DEG2RADf, 797
 kBMATH_Ed, 796
 kBMATH_Ef, 796
 kBMATH_INFINITYd, 798
 kBMATH_INFINITYf, 798
 kBMATH_LN10d, 797
 kBMATH_LN10f, 797
 kBMATH_LN2d, 796
 kBMATH_LN2f, 796
 kBMATH_PId, 797
 kBMATH_PIf, 797
 kBMATH_RAD2DEGd, 797
 kBMATH_RAD2DEGf, 797
 kBMATH_SQRT2d, 797
 kBMATH_SQRT2f, 797
 kBMATH_SQRT3d, 797
 kBMATH_SQRT3f, 797
 kBOX2D_NULLd, 1042
 kBOX2D_NULLf, 1042
 kCIR2D_NULLd, 1042
 kCIR2D_NULLf, 1042
 kCOLOR_BLACK, 1113
 kCOLOR_BLUE, 1114
 kCOLOR_CYAN, 1114
 kCOLOR_DEFAULT, 1113
 kCOLOR_GREEN, 1114
 kCOLOR_MAGENTA, 1114
 kCOLOR_RED, 1113
 kCOLOR_TRANSPARENT, 1113
 kCOLOR_WHITE, 1113

 kCOLOR_YELLOW, 1114
 kDATE_NULL, 890
 kDEG2RAD, 797
 kDEVNULL, 890
 kE, 796
 KeyBuf, 898
 keybuf_clear, 1025
 keybuf_create, 1024
 keybuf_destroy, 1024
 keybuf_dump, 1026
 keybuf_OnDown, 1024
 keybuf_OnUp, 1024
 keybuf_pressed, 1025
 keybuf_str, 1025
 kIDENT, 1042
 kINFINITY, 798
 kLN10, 797
 kLN2, 796
 kNULL, 1042
 kPI, 797
 kR2D_ZEROd, 1042
 kR2D_ZEROf, 1042
 kRAD2DEG, 797
 kS2D_ZEROd, 1041
 kS2D_ZEROf, 1041
 kSQRT2, 797
 kSQRT3, 797
 kSTDERR, 889
 kSTDIN, 889
 kSTDOUT, 889
 kT2D_IDENTd, 1042
 kT2D_IDENTf, 1042
 kV2D_Xd, 1041
 kV2D_Xf, 1041
 kV2D_Yd, 1041
 kV2D_Yf, 1041
 kV2D_ZEROd, 1041
 kV2D_ZEROf, 1041
 kX, 1041
 kY, 1041
 kZERO, 1041, 1042

Label, 1179
label_align, 1204
label_bgcolor, 1205
label_bgcolor_over, 1205
label_color, 1204
label_color_over, 1204
label_create, 1202
label_font, 1203
label_multiline, 1202
label_OnClick, 1202
label_size_text, 1203
label_style_over, 1204
label_text, 1203
Layout, 1181
layout_bgcolor, 1295
layout_button, 1274
layout_cell, 1273
layout_combo, 1275
layout_control, 1273
layout_create, 1273
layout_dbind, 1296
layout_dbind_obj, 1296
layout_dbind_update, 1296
layout_edit, 1275
layout_get_button, 1280
layout_get_combo, 1281
layout_get_edit, 1281
layout_get_imageview, 1284
layout_get_label, 1280
layout_get_layout, 1286
layout_get_listbox, 1282
layout_get_panel, 1285
layout_get_popup, 1280
layout_get_progress, 1283
layout_get_slider, 1282
layout_get_splitview, 1285
layout_get_tableview, 1284
layout_get_textview, 1283
layout_get_updown, 1282
layout_get_view, 1283
layout_get_webview, 1284
layout_halign, 1292
layout_hexpand, 1290
layout_hexpand2, 1290
layout_hexpand3, 1291
layout_hmargin, 1289
layout_hsize, 1289
layout_imageview, 1278
layout_insert_col, 1287
layout_insert_row, 1287
layout_label, 1274
layout_layout, 1279
layout_listbox, 1275
layout_margin, 1294
layout_margin2, 1294
layout_margin4, 1294
layout_ncols, 1286
layout_nrows, 1286
layout_panel, 1279
layout_panel_replace, 1279
layout_popup, 1274
layout_progress, 1276
layout_remove_col, 1287
layout_remove_row, 1288
layout_show_col, 1293
layout_show_row, 1293
layout_skcolor, 1295
layout_slider, 1276
layout_splitview, 1278
layout_tableview, 1278
layout_taborder, 1288
layout_tabstop, 1288
layout_textview, 1277
layout_update, 1295
layout_updown, 1276
layout_valign, 1293
layout_vexpand, 1291
layout_vexpand2, 1291
layout_vexpand3, 1292
layout_view, 1277
layout_vmargint, 1290
layout_vsize, 1289
layout_webview, 1277
linecap_t, 1115

linejoin_t, 1116
 ListBox, 1180
 listbox_add_elem, 1229
 listbox_check, 1231
 listbox_checkbox, 1229
 listbox_checked, 1232
 listbox_clear, 1230
 listbox_color, 1230
 listbox_count, 1231
 listbox_create, 1227
 listbox_multisel, 1229
 listbox_OnDown, 1227
 listbox_OnSelect, 1228
 listbox_select, 1231
 listbox_selected, 1232
 listbox_set_elem, 1230
 listbox_size, 1229
 listbox_text, 1232
 listen, 1021
 Listener, 898
 listener, 1020
 listener_destroy, 1021
 listener_event, 1021
 listener_pass_event, 1022
 listener_update, 1021
 log_file, 888
 log_get_file, 888
 log_output, 887
 log_printf, 887

 Menu, 1182
 menu_create, 1317
 menu_destroy, 1317
 menu_get_item, 1319
 menu_hide, 1318
 menu_item, 1318
 menu_launch, 1318
 menu_off_items, 1318
 menu_size, 1319
 MenuItem, 1182
 menuitem_create, 1319
 menuitem_enabled, 1320
 menuitem_image, 1321
 menuitem_key, 1321
 menuitem_OnClick, 1320
 menuitem_separator, 1319
 menuitem_state, 1321
 menuitem_submenu, 1321
 menuitem_text, 1320
 menuitem_visible, 1320
 mkey_t, 894
 month_t, 854
 Mutex, 858

 NULL, 794

 OBB2D, 1046
 OBB2D::angle, 1085
 OBB2D::area, 1085
 OBB2D::box, 1086
 OBB2D::center, 1084
 OBB2D::copy, 1081
 OBB2D::corners, 1083
 OBB2D::create, 1079
 OBB2D::destroy, 1082
 OBB2D::from_line, 1080
 OBB2D::from_points, 1081
 OBB2D::height, 1085
 OBB2D::move, 1083
 OBB2D::transform, 1083
 OBB2D::update, 1082
 OBB2D::width, 1084
 obb2d_angled, 1085
 obb2d_anglelf, 1085
 obb2d_aread, 1085
 obb2d_areaf, 1085
 obb2d_boxd, 1086
 obb2d_boxf, 1086
 obb2d_centerd, 1084
 obb2d_centerf, 1084
 obb2d_copyd, 1081
 obb2d_copyf, 1081
 obb2d_cornersd, 1083
 obb2d_cornersf, 1083

obb2d_created, 1079
 obb2d_createf, 1079
 obb2d_destroyd, 1082
 obb2d_destroyf, 1082
 obb2d_from_lined, 1080
 obb2d_from_linef, 1080
 obb2d_from_pointsd, 1081
 obb2d_from_pointsf, 1081
 obb2d_heightd, 1085
 obb2d_heightf, 1085
 obb2d_moved, 1083
 obb2d_movef, 1083
 obb2d_transformd, 1083
 obb2d_transformf, 1083
 obb2d_updated, 1082
 obb2d_updatef, 1082
 obb2d_widthd, 1084
 obb2d_widthf, 1084
 ogl3d_begin_draw, 1348
 ogl3d_context, 1347
 ogl3d_destroy, 1348
 ogl3d_end_draw, 1348
 ogl3d_err_str, 1349
 ogl3d_finish, 1347
 ogl3d_set_size, 1349
 ogl3d_start, 1347
 oglapi_t, 1345
 OGLCtx, 1347
 oglerr_t, 1346
 OGLProps, 1346
 osapp_argc, 1327
 osapp_argv, 1328
 osapp_finish, 1327
 osapp_menubar, 1329
 osapp_open_url, 1329
 osapp_task, 1328
 osbs_endian, 859
 osbs_finish, 859
 osbs_platform, 859
 osbs_start, 859
 osbs_windows, 859
 osmain, 1326
 osmain_sync, 1327
 Palette, 1117
 palette_binary, 1147
 palette_cga2, 1144
 palette_colors, 1147
 palette_colors_const, 1148
 palette_create, 1144
 palette_destroy, 1147
 palette_ega4, 1145
 palette_gray1, 1145
 palette_gray2, 1146
 palette_gray4, 1146
 palette_gray8, 1146
 palette_rgb8, 1145
 palette_size, 1147
 Panel, 1181
 panel_create, 1304
 panel_custom, 1304
 panel_data, 1305
 panel_get_data, 1305
 panel_get_layout, 1306
 panel_layout, 1306
 panel_scroll, 1304
 panel_scroll_height, 1307
 panel_scroll_width, 1307
 panel_size, 1305
 panel_update, 1307
 panel_visible_layout, 1306
 perror_t, 856
 Pixbuf, 1118
 pixbuf_cdata, 1151
 pixbuf_convert, 1149
 pixbuf_copy, 1148
 pixbuf_create, 1148
 pixbuf_data, 1152
 pixbuf_destroy, 1150
 pixbuf_dsize, 1151
 pixbuf_format, 1150
 pixbuf_format_bpp, 1152
 pixbuf_get, 1152
 pixbuf_height, 1150

pixbuf_set, 1153
 pixbuf_size, 1151
 pixbuf_trim, 1149
 pixbuf_width, 1150
 pixformat_t, 1114
 platform_t, 853
 Pol2D, 1047
 Pol2D::area, 1092
 Pol2D::box, 1093
 Pol2D::ccw, 1093
 Pol2D::centroid, 1094
 Pol2D::convex, 1093
 Pol2D::convex_hull, 1090
 Pol2D::convex_partition, 1095
 Pol2D::copy, 1090
 Pol2D::create, 1089
 Pol2D::destroy, 1091
 Pol2D::n, 1092
 Pol2D::points, 1091
 Pol2D::transform, 1091
 Pol2D::triangles, 1095
 Pol2D::visual_center, 1094
 pol2d_aread, 1092
 pol2d_areaf, 1092
 pol2d_boxd, 1093
 pol2d_boxf, 1093
 pol2d_ccwd, 1093
 pol2d_ccwf, 1093
 pol2d_centroidd, 1094
 pol2d_centroidf, 1094
 pol2d_convex_hulld, 1090
 pol2d_convex_hullf, 1090
 pol2d_convex_partitiond, 1095
 pol2d_convex_partitionf, 1095
 pol2d_convexd, 1093
 pol2d_convexf, 1093
 pol2d_copyd, 1090
 pol2d_copyf, 1090
 pol2d_created, 1089
 pol2d_createf, 1089
 pol2d_destroyd, 1091
 pol2d_destroyf, 1091
 pol2d_nd, 1092
 pol2d_nf, 1092
 pol2d_pointsd, 1091
 pol2d_pointsf, 1091
 pol2d_transformd, 1091
 pol2d_transformf, 1091
 pol2d_trianglesd, 1095
 pol2d_trianglesf, 1095
 pol2d_visual_centerd, 1094
 pol2d_visual_centerf, 1094
 PopUp, 1179
 popup_add_elem, 1212
 popup_clear, 1213
 popup_count, 1213
 popup_create, 1211
 popup_get_selected, 1214
 popup_get_text, 1214
 popup_list_height, 1213
 popup_OnSelect, 1211
 popup_selected, 1213
 popup_set_elem, 1212
 popup_tooltip, 1212
 Proc, 858
 Progress, 1180
 progress_create, 1236
 progress_undefined, 1236
 progress_value, 1236
 ptr_assign, 804
 ptr_copyopt, 805
 ptr_destopt, 804
 ptr_dget, 803
 ptr_dget_no_null, 804
 ptr_get, 803
 R2D, 1043, 1058
 R2D::center, 1059
 R2D::clip, 1061
 R2D::collide, 1060
 R2D::contains, 1060
 R2D::join, 1061
 r2d_centerd, 1059
 r2d_centerf, 1059

r2d_clipd, 1061
 r2d_cliplf, 1061
 r2d_collided, 1060
 r2d_collidef, 1060
 r2d_containsd, 1060
 r2d_containsf, 1060
 r2d_joind, 1061
 r2d_joinf, 1061
 r2dd, 1058
 r2df, 1058
 real, 794
 real32_t, 794
 real64_t, 794
 RegEx, 898
 regex_create, 1014
 regex_destroy, 1015
 regex_match, 1015
 REnv, 798
 ResId, 899
 resid_image, 1118
 ResPack, 899
 respack_destroy, 1034
 respack_file, 1034
 respack_text, 1034

 S2D, 1043, 1058
 s2dd, 1058
 s2df, 1058
 Seg2D, 1044, 1067
 Seg2D::close_param, 1070
 Seg2D::eval, 1069
 Seg2D::length, 1069
 Seg2D::point_sqdist, 1070
 Seg2D::sqdist, 1071
 Seg2D::sqlength, 1069
 Seg2D::v, 1068
 seg2d_close_paramd, 1070
 seg2d_close_paramf, 1070
 seg2d_evald, 1069
 seg2d_evalf, 1069
 seg2d_lengthd, 1069
 seg2d_lengthf, 1069
 seg2d_point_sqdistd, 1070
 seg2d_point_sqdistf, 1070
 seg2d_sqdistd, 1071
 seg2d_sqdistf, 1071
 seg2d_sqlengthd, 1069
 seg2d_sqlengthf, 1069
 seg2d_vd, 1068
 seg2d_vf, 1068
 seg2dd, 1067
 seg2df, 1067
 serror_t, 856
 SetPt, 897
 setpt_create, 1006
 setpt_delete, 1008
 setpt_destroy, 1006
 setpt_first, 1009
 setpt_first_const, 1009
 setpt_forback, 1013
 setpt_forback_const, 1013
 setpt_foreach, 1012
 setpt_foreach_const, 1012
 setpt_fornext, 1012
 setpt_fornext_const, 1013
 setpt_forprev, 1014
 setpt_forprev_const, 1014
 setpt_get, 1007
 setpt_get_const, 1007
 setpt_insert, 1008
 setpt_last, 1010
 setpt_last_const, 1010
 setpt_next, 1010
 setpt_next_const, 1011
 setpt_prev, 1011
 setpt_prev_const, 1011
 setpt_size, 1006
 SetSt, 897
 setst_create, 997
 setst_delete, 999
 setst_destroy, 997
 setst_first, 1000
 setst_first_const, 1001
 setst_forback, 1004

setst_forback_const, 1005
setst_foreach, 1003
setst_foreach_const, 1003
setst_fornext, 1004
setst_fornext_const, 1004
setst_forprev, 1005
setst_forprev_const, 1005
setst_get, 998
setst_get_const, 998
setst_insert, 999
setst_last, 1001
setst_last_const, 1001
setst_next, 1002
setst_next_const, 1002
setst_prev, 1002
setst_prev_const, 1003
setst_size, 997
Slider, 1180
slider_create, 1234
slider_get_value, 1235
slider_OnMoved, 1234
slider_steps, 1235
slider_tooltip, 1235
slider_value, 1235
slider_vertical, 1234
Socket, 858
SplitView, 1181
splitview_horizontal, 1270
splitview_panel, 1272
splitview_pos, 1272
splitview_size, 1271
splitview_split, 1272
splitview_text, 1271
splitview_vertical, 1270
splitview_view, 1271
sstate_t, 890
stm_append_file, 938
stm_buffer, 947
stm_buffer_size, 948
stm_bytes_readed, 942
stm_bytes_written, 942
stm_close, 939
stm_col, 942
stm_corrupt, 947
stm_file_err, 946
stm_flush, 965
stm_from_block, 937
stm_from_file, 937
stm_get_read_endian, 939
stm_get_read_utf, 941
stm_get_write_endian, 939
stm_get_write_utf, 940
stm_is_memory, 942
stm_lines, 966
stm_memory, 937
stm_next, 966
stm_pipe, 965
stm_printf, 949
stm_read, 954
stm_read_bool, 960
stm_read_char, 954
stm_read_chars, 954
stm_read_enum, 963
stm_read_i16, 960
stm_read_i16_tok, 956
stm_read_i32, 961
stm_read_i32_tok, 957
stm_read_i64, 961
stm_read_i64_tok, 957
stm_read_i8, 960
stm_read_i8_tok, 956
stm_read_line, 955
stm_read_r32, 963
stm_read_r32_tok, 959
stm_read_r64, 963
stm_read_r64_tok, 959
stm_read_token, 956
stm_read_trim, 955
stm_read_u16, 962
stm_read_u16_tok, 958
stm_read_u32, 962
stm_read_u32_tok, 958
stm_read_u64, 962
stm_read_u64_tok, 959

stm_read_u8, 961
stm_read_u8_tok, 957
stm_row, 943
stm_set_read_endian, 940
stm_set_read_utf, 941
stm_set_write_endian, 940
stm_set_write_utf, 941
stm_skip, 964
stm_skip_bom, 964
stm_skip_token, 964
stm_sock_err, 946
stm_socket, 939
stm_state, 946
stm_str, 947
stm_to_file, 938
stm_token_col, 943
stm_token_comments, 945
stm_token_escapes, 944
stm_token_lexeme, 944
stm_token_row, 944
stm_token_spaces, 945
stm_write, 948
stm_write_bool, 950
stm_write_char, 948
stm_write_enum, 953
stm_write_i16, 950
stm_write_i32, 951
stm_write_i64, 951
stm_write_i8, 950
stm_write_r32, 953
stm_write_r64, 953
stm_write_u16, 952
stm_write_u32, 952
stm_write_u64, 952
stm_write_u8, 951
stm_writef, 949
str_c, 912
str_cat, 918
str_cat_c, 919
str_cmp, 922
str_cmp_c, 923
str_cmp_cn, 923
str_cn, 912
str_copy, 913
str_copy_c, 918
str_copy_cn, 918
str_cpath, 914
str_crepath, 915
str_destopt, 920
str_destroy, 920
str_empty, 923
str_empty_c, 924
str_equ, 924
str_equ_c, 924
str_equ_cn, 925
str_equ_end, 925
str_equ_nocase, 925
str_filename, 931
str_flex, 931
str_fill, 916
str_find, 932
str_is_prefix, 921
str_is_sufix, 922
str_len, 920
str_len_c, 920
str_lower, 926
str_lower_c, 927
str_nchars, 921
str_path, 914
str_prefix, 921
str_printf, 913
str_read, 916
str_relpath, 915
str_repl, 915
str_repl_c, 928
str_reserve, 916
str_scmp, 922
str_split, 928
str_split_pathext, 931
str_split_pathname, 930
str_split_trim, 929
str_splits, 930
str_str, 928
str_subs, 927

str_to_i16, 933
 str_to_i32, 933
 str_to_i64, 933
 str_to_i8, 932
 str_to_r32, 936
 str_to_r64, 936
 str_to_u16, 934
 str_to_u32, 935
 str_to_u64, 935
 str_to_u8, 934
 str_trim, 912
 str_trim_n, 913
 str_upd, 919
 str_upper, 926
 str_upper_c, 926
 str_write, 917
 str_writef, 917
 Stream, 897
 String, 897

 T2D, 1044
 T2D::decompose, 1067
 T2D::inverse, 1065
 T2D::invfast, 1064
 T2D::move, 1062
 T2D::mult, 1065
 T2D::rotate, 1063
 T2D::scale, 1063
 T2D::vmult, 1066
 T2D::vmultn, 1066
 t2d_decomposed, 1067
 t2d_decomposef, 1067
 t2d_inversed, 1065
 t2d_inversef, 1065
 t2d_invfastd, 1064
 t2d_invfastf, 1064
 t2d_moved, 1062
 t2d_movef, 1062
 t2d_multd, 1065
 t2d_multf, 1065
 t2d_rotated, 1063
 t2d_rotatef, 1063

 t2d_scaled, 1063
 t2d_scalef, 1063
 t2d_tod, 1062
 t2d_tof, 1062
 t2d_vmultd, 1066
 t2d_vmultf, 1066
 t2d_vmultnd, 1066
 t2d_vmultnf, 1066
 TableView, 1181
 tableview_column_freeze, 1263
 tableview_column_limits, 1263
 tableview_column_resizable, 1263
 tableview_column_width, 1262
 tableview_create, 1260
 tableview_deselect, 1268
 tableview_deselect_all, 1268
 tableview_focus_row, 1269
 tableview_font, 1261
 tableview_get_focus_row, 1269
 tableview_grid, 1267
 tableview_header_align, 1264
 tableview_header_clickable, 1265
 tableview_header_height, 1265
 tableview_header_resizable, 1265
 tableview_header_title, 1264
 tableview_header_visible, 1264
 tableview_hkey_scroll, 1266
 tableview_multisel, 1267
 tableview_new_column_text, 1262
 tableview_OnData, 1260
 tableview_OnHeaderClick, 1261
 tableview_OnRowClick, 1261
 tableview_OnSelect, 1260
 tableview_row_height, 1266
 tableview_scroll_visible, 1270
 tableview_select, 1268
 tableview_selected, 1269
 tableview_size, 1262
 tableview_update, 1267
 tc, 911
 tcc, 911
 TextView, 1180

textview_afspace, 1253
 textview_apply_all, 1253
 textview_apply_sel, 1254
 textview_bfspace, 1253
 textview_bgcolor, 1252
 textview_clear, 1249
 textview_color, 1251
 textview_copy, 1256
 textview_create, 1248
 textview_cut, 1256
 textview_editable, 1254
 textview_family, 1250
 textview_fsize, 1251
 textview_fstyle, 1251
 textview_get_text, 1255
 textview_halign, 1252
 textview_lspacing, 1252
 textview_OnFilter, 1248
 textview_OnFocus, 1248
 textview_paste, 1256
 textview_pcolor, 1252
 textview_printf, 1249
 textview_rtf, 1250
 textview_scroll_caret, 1255
 textview_scroll_visible, 1254
 textview_select, 1254
 textview_show_select, 1255
 textview_size, 1249
 textview_units, 1250
 textview_wrap, 1256
 textview_writeln, 1250
 Thread, 858
 token_t, 895
 Tri2D, 1046, 1086
 Tri2D::area, 1088
 Tri2D::ccw, 1088
 Tri2D::centroid, 1089
 Tri2D::transform, 1088
 Tri2D::v, 1087
 tri2d_aread, 1088
 tri2d_areaf, 1088
 tri2d_ccwd, 1088

tri2d_ccwf, 1088
 tri2d_centroidd, 1089
 tri2d_centroidf, 1089
 tri2d_transformd, 1088
 tri2d_transformf, 1088
 tri2d_vd, 1087
 tri2d_vf, 1087
 tri2dd, 1086
 tri2df, 1086
 TRUE, 794

 UINT16_MAX, 796
 uint16_t, 793
 UINT32_MAX, 796
 uint32_t, 793
 UINT64_MAX, 796
 uint64_t, 794
 UINT8_MAX, 796
 uint8_t, 793
 unicode_back, 811
 unicode_convers, 805
 unicode_convers_n, 806
 unicode_convers_nbytes, 806
 unicode_convers_nbytes_n, 807
 unicode_isalnum, 812
 unicode_isalpha, 813
 unicode_isascii, 812
 unicode_iscntrl, 813
 unicode_isdigit, 813
 unicode_isgraph, 814
 unicode_islower, 815
 unicode_isprint, 814
 unicode_ispunct, 814
 unicode_isspace, 815
 unicode_isupper, 816
 unicode_isxdigit, 815
 unicode_move, 811
 unicode_nbytes, 807
 unicode_nchars, 808
 unicode_next, 810
 unicode_t, 798
 unicode_to_char, 809

unicode_to_u32, 808
 unicode_to_u32b, 808
 unicode_tolower, 816
 unicode_toupper, 816
 unicode_valid, 810
 unicode_valid_str, 809
 unicode_valid_str_n, 810
 unref, 800
 UpDown, 1180
 updown_create, 1233
 updown_OnClick, 1233
 updown_tooltip, 1233
 Url, 1331
 url_destroy, 1339
 url_fragment, 1341
 url_host, 1340
 url_params, 1341
 url_parse, 1339
 url_pass, 1340
 url_path, 1340
 url_port, 1342
 url_query, 1341
 url_resource, 1341
 url_scheme, 1339
 url_user, 1340

 V2D, 1042, 1047
 V2D::add, 1049
 V2D::angle, 1057
 V2D::dist, 1056
 V2D::dot, 1055
 V2D::from, 1050
 V2D::from_angle, 1054
 V2D::length, 1055
 V2D::mid, 1051
 V2D::mul, 1050
 V2D::norm, 1054
 V2D::perp_neg, 1053
 V2D::perp_pos, 1053
 V2D::rotate, 1058
 V2D::sqdist, 1056
 V2D::sqlength, 1055
 V2D::sub, 1049
 V2D::unit, 1051
 V2D::unit_xy, 1052
 v2d_addd, 1049
 v2d_addf, 1049
 v2d_angled, 1057
 v2d_anglef, 1057
 v2d_distd, 1056
 v2d_distf, 1056
 v2d_dotd, 1055
 v2d_dotf, 1055
 v2d_from_angled, 1054
 v2d_from_anglef, 1054
 v2d_fromd, 1050
 v2d_fromf, 1050
 v2d_lengthd, 1055
 v2d_lengthf, 1055
 v2d_midd, 1051
 v2d_midf, 1051
 v2d_muld, 1050
 v2d_mulf, 1050
 v2d_normd, 1054
 v2d_normf, 1054
 v2d_perp_negd, 1053
 v2d_perp_negf, 1053
 v2d_perp_posd, 1053
 v2d_perp_posf, 1053
 v2d_rotated, 1058
 v2d_rotatef, 1058
 v2d_sqdistd, 1056
 v2d_sqdistf, 1056
 v2d_sqlengthd, 1055
 v2d_sqlengthf, 1055
 v2d_subd, 1049
 v2d_subf, 1049
 v2d_tod, 1048
 v2d_todn, 1049
 v2d_tof, 1048
 v2d_tofn, 1048
 v2d_unit_xyd, 1052
 v2d_unit_xyf, 1052
 v2d_unitd, 1051

v2d_unitf, 1051
v2dd, 1047
v2df, 1047
View, 1180
view_allow_tab, 1244
view_content_size, 1245
view_create, 1236
view_custom, 1237
view_data, 1237
view_get_data, 1238
view_get_size, 1245
view_keybuf, 1244
view_native, 1247
view_OnAcceptFocus, 1243
view_OnClick, 1241
view_OnDown, 1240
view_OnDrag, 1241
view_OnDraw, 1238
view_OnEnter, 1239
view_OnExit, 1240
view_OnFocus, 1243
view_OnKeyDown, 1242
view_OnKeyUp, 1242
view_OnMove, 1240
view_OnOverlay, 1239
view_OnResignFocus, 1243
view_OnScroll, 1244
view_OnSize, 1239
view_OnUp, 1241
view_OnWheel, 1242
view_point_scale, 1247
view_scroll, 1237
view_scroll_size, 1246
view_scroll_visible, 1246
view_scroll_x, 1245
view_scroll_y, 1246
view_size, 1238
view_update, 1247
view_viewport, 1246
vkey_t, 890
webview_back, 1258
webview_create, 1257
webview_forward, 1258
webview_navigate, 1258
webview_OnFocus, 1257
webview_size, 1257
week_day_t, 854
win_t, 853
Window, 1181
window_clear_hotkeys, 1312
window_client_to_screen, 1316
window_control_frame, 1316
window_create, 1308
window_cursor, 1317
window_cycle_tabstop, 1312
window_defbutton, 1316
window_destroy, 1308
window_flag_t, 1177
window_focus, 1313
window_focus_info, 1314
window_get_client_size, 1315
window_get_focus, 1313
window_get_origin, 1315
window_get_size, 1315
window_hide, 1310
window_hotkey, 1311
window_modal, 1310
window_next_tabstop, 1312
window_OnClose, 1308
window_OnMoved, 1309
window_OnResize, 1309
window_origin, 1314
window_overlay, 1310
window_panel, 1308
window_previous_tabstop, 1313
window_show, 1310
window_size, 1314
window_stop_modal, 1311
window_title, 1309
window_update, 1314

WebView, 1180

